



ACGME

Accreditation Council for
Graduate Medical Education

MILESTONES

NATIONAL REPORT

2022

Laura Edgar, EdD, CAE

Sean O. Hogan, PhD

Eric S. Holmboe, MD

Sudarshan Kondur, MS

Rayan Shammet, MPH

Hina Shah, BA

Kenji Yamazaki, PhD

MILESTONES NATIONAL REPORT 2022

EXECUTIVE SUMMARY

Since 2013, the Milestones have allowed for continuous tracking of skill and competence development of resident and fellow physicians throughout their graduate medical education (GME) program(s). This report is a snapshot of Milestones ratings for the end of the July 1, 2021 through June 30, 2022 academic year. The COVID-19 pandemic continued to be disruptive to the GME community for a second full academic year. The magnitude and nature of the disruptions varied by specialty and region. The data reported in this 2022 report should be interpreted in the context of that disruption.

General Summary of Findings

- 1) Across all specialties, the number of subcompetencies assessed is provided.
- 2) Across all specialties, box plots show the mean and median of Milestones ratings, as well as the variance, in general attainment across years.
- 3) Overall rates of straight-lining (which may be an indicator of bias or difficulty interpreting specific milestones within a local context), do not appear to have been significantly affected as many specialties have transitioned to Milestones 2.0.

The ACGME website includes many resources to help understand the purpose and effective use of the Milestones and Milestones ratings. These include the *Milestones Guidebook*, the *Milestones Guidebook for Residents and Fellows*, and Milestones FAQs, as well as the *Assessment Guidebook*, the *Implementation Guidebook*, and the *Clinical Competency Committee Guidebook*, all accessible on the [Resources page](#) of the Milestones section of the ACGME website.

Intended Audience

The intended audience for this report includes program directors and members of programs' Clinical Competency Committees (CCCs); leaders within specialty societies who oversee the development of national curricula; members of the ACGME Review Committees that oversee accreditation of individual programs; and the residents, fellows, and faculty members in these programs. Other stakeholders who may benefit from this report include specialty boards, designated institutional officials (DIOs), policymakers, and the public.

MILESTONES NATIONAL REPORT 2022

TABLE OF CONTENTS

(Click any category below to advance to a specific table)

Background	9
How to Use These Findings	10
Table 1 – Purpose and Function of Milestones	10
Methods	11
Overarching Themes	11
Future Directions	12
References	14
Table 2 – Number of Subcompetencies by Specialty	15
Table 3 – Number of Residents by Year in Program	19
Table 4 – Rate of Straight-Lining (June 2022)	23
Figure 1: Key to Box Plots	27
Table 5 – Allergy and Immunology MILESTONES DATA BOX PLOTS	29
Table 6 – Anesthesiology MILESTONES DATA BOX PLOTS	33
Tables 7-12 – Anesthesiology Subspecialties MILESTONES DATA BOX PLOTS	37
Table 7 Adult Cardiothoracic Anesthesiology	
Table 8 Critical Care Anesthesiology	
Table 9 Obstetric Anesthesiology	
Table 10 Pain Medicine (multidisciplinary)	
Table 11 Pediatric Anesthesiology	
Table 12 Regional Anesthesiology and Acute Pain Medicine	
Table 13 – Colon and Rectal Surgery MILESTONES DATA BOX PLOTS	56
Table 14 – Dermatology MILESTONES DATA BOX PLOTS	61
Tables 15-16 – Dermatology Subspecialties MILESTONES DATA BOX PLOTS	65
Table 15 Dermatopathology (multidisciplinary)	
Table 16 Micrographic Surgery and Dermatologic Oncology	
Table 17 – Emergency Medicine (Three- and Four-Year Programs) MILESTONES DATA BOX PLOTS	70
Tables 18-22 – Emergency Medicine Subspecialties MILESTONES DATA BOX PLOTS	78
Table 18 Emergency Medical Services	

MILESTONES NATIONAL REPORT 2022

Table 19 Medical Toxicology (multidisciplinary)	
Table 20 Pediatric Emergency Medicine (multidisciplinary)	
Table 21 Sports Medicine (multidisciplinary)	
Table 22 Undersea and Hyperbaric Medicine (multidisciplinary)	
Table 23 – Family Medicine MILESTONES DATA BOX PLOTS	94
Tables 24-27 – Family Medicine Subspecialties MILESTONES DATA BOX PLOTS	98
Table 24 Clinical Informatics (multidisciplinary)	
Table 25 Geriatric Medicine (multidisciplinary)	
Table 26 Hospice and Palliative Medicine (multidisciplinary)	
Table 27 Sports Medicine (multidisciplinary)	
Table 28 – Internal Medicine MILESTONES DATA BOX PLOTS	114
Tables 29-48 – Internal Medicine Subspecialties MILESTONES DATA BOX PLOTS	118
Table 29 Adult Congenital Heart Disease	
Table 30 Advanced Heart Failure and Transplant Cardiology	
Table 31 Cardiovascular Disease	
Table 32 Clinical Cardiac Electrophysiology	
Table 33 Clinical Informatics (multidisciplinary)	
Table 34 Critical Care Medicine	
Table 35 Endocrinology, Diabetes, and Metabolism	
Table 36 Gastroenterology	
Table 37 Gastroenterology – Transplant Hepatology Pathway	
Table 38 Geriatric Medicine (multidisciplinary)	
Table 39 Hematology and Medical Oncology	
Table 40 Infectious Disease	
Table 41 Interventional Cardiology	
Table 42 Medical Oncology	
Table 43 Nephrology	
Table 44 Pulmonary Disease	
Table 45 Pulmonary Disease and Critical Care Medicine	
Table 46 Rheumatology	
Table 47 Sleep Medicine (multidisciplinary)	
Table 48 Transplant Hepatology	
Table 49 – Medical Genetics and Genomics MILESTONES DATA BOX PLOTS	193
Tables 50-53 – Medical Genetics and Genomics Subspecialties MILESTONES DATA BOX PLOTS	196
Table 50 Clinical Biochemical Genetics	

MILESTONES NATIONAL REPORT 2022

Table 51 Laboratory Genetics and Genomics	
Table 52 Medical Biochemical Genetics	
Table 53 Molecular Genetic Pathology (multidisciplinary)	
Table 54 – Neurological Surgery MILESTONES DATA BOX PLOTS	211
Table 55 – Neurology MILESTONES DATA BOX PLOTS	215
Tables 56-59 – Neurology Subspecialties MILESTONES DATA BOX PLOTS	220
Table 56 Clinical Neurophysiology	
Table 57 Epilepsy	
Table 58 Neurodevelopmental Disabilities	
Table 59 Neuromuscular Medicine (multidisciplinary)	
Table 60 Vascular Neurology	
Table 61 – Child Neurology MILESTONES DATA BOX PLOTS	242
Table 62 – Nuclear Medicine MILESTONES DATA BOX PLOTS	247
Table 63 – Obstetrics and Gynecology MILESTONES DATA BOX PLOTS	251
Tables 64-67 – Obstetrics and Gynecology Subspecialties MILESTONES DATA BOX PLOTS	256
Table 64 Female Pelvic Medicine and Reconstructive Surgery (multidisciplinary)	
Table 65 Gynecologic Oncology	
Table 66 Maternal-Fetal Medicine	
Table 67 Reproductive Endocrinology and Infertility	
Table 68 – Ophthalmology MILESTONES DATA BOX PLOTS	270
Table 69 – Orthopaedic Surgery MILESTONES DATA BOX PLOTS	274
Tables 70-77 – Orthopaedic Surgery Subspecialties MILESTONES DATA BOX PLOTS	278
Table 70 Adult Reconstructive Orthopaedic Surgery	
Table 71 Foot and Ankle Orthopaedic Surgery	
Table 72 Hand Surgery (multidisciplinary)	
Table 73 Musculoskeletal Oncology	
Table 74 Orthopaedic Sports Medicine	
Table 75 Orthopaedic Surgery of the Spine	
Table 76 Orthopaedic Trauma	
Table 77 Pediatric Orthopaedic Surgery	
Table 78 – Osteopathic Neuromusculoskeletal Medicine MILESTONES DATA BOX PLOTS	306
Table 79 – Otolaryngology - Head and Neck Surgery MILESTONES DATA BOX PLOTS	309

MILESTONES NATIONAL REPORT 2022

Tables 80-81 – Otolaryngology - Head and Neck Surgery Subspecialties MILESTONES DATA BOX PLOTS 312

Table 80 Neurotology

Table 81 Pediatric Otolaryngology

Tables 82 – Pathology (Anatomic and Clinical) MILESTONES DATA BOX PLOTS318

Tables 83-92 – Pathology Subspecialties MILESTONES DATA BOX PLOTS 322

Table 83 Blood Banking/Transfusion Medicine

Table 84 Clinical Informatics (multidisciplinary)

Table 85 Cytopathology

Table 86 Forensic Pathology

Table 87 Hematopathology

Table 88 Medical Microbiology

Table 89 Neuropathology

Table 90 Pediatric Pathology

Table 91 Selective Pathology (Focused Anatomic)

Table 92 Selective Pathology (Surgical)

Table 93 – Pediatrics MILESTONES DATA BOX PLOTS 362

Tables 94-111 – Pediatrics Subspecialties MILESTONES DATA BOX PLOTS 366

Table 94 Adolescent Medicine

Table 95 Child Abuse Pediatrics

Table 96 Clinical Informatics (multidisciplinary)

Table 97 Developmental-Behavioral Pediatrics

Table 98 Neonatal-Perinatal Medicine

Table 99 Pediatric Cardiology

Table 100 Pediatric Critical Care Medicine

Table 101 Pediatric Emergency Medicine (multidisciplinary)

Table 102 Pediatric Endocrinology

Table 103 Pediatric Gastroenterology

Table 104 Pediatric Hematology Oncology

Table 105 Pediatric Hospital Medicine

Table 106 Pediatric Infectious Diseases

Table 107 Pediatric Nephrology

Table 108 Pediatric Pulmonology

Table 109 Pediatric Rheumatology

Table 110 Pediatric Transplant Hepatology

Table 111 Sports Medicine (multidisciplinary)

Table 112 – Physical Medicine and Rehabilitation MILESTONES DATA BOX PLOTS 437

MILESTONES NATIONAL REPORT 2022

Tables 113-116 – Physical Medicine and Rehabilitation Subspecialties MILESTONES DATA BOX PLOTS ...	441
Table 113 Brain Injury Medicine (multidisciplinary)	
Table 114 Pediatric Rehabilitation Medicine	
Table 115 Spinal Cord Injury Medicine	
Table 116 Sports Medicine (multidisciplinary)	
Table 117 – Plastic Surgery - Independent MILESTONES DATA BOX PLOTS	456
Table 118 – Plastic Surgery - Integrated MILESTONES DATA BOX PLOTS	462
Table 119 – Plastic Surgery - Integrated Subspecialties MILESTONES DATA BOX PLOTS	468
Table 119 Hand Surgery (multidisciplinary)	
Table 120 – Preventive Medicine (Aerospace Medicine) MILESTONES DATA BOX PLOTS	471
Table 121 – Preventive Medicine (Occupational Medicine) MILESTONES DATA BOX PLOTS	475
Table 122 – Preventive Medicine (Public Health and General Preventive Medicine) MILESTONES DATA BOX PLOTS	479
Table 123 – Psychiatry MILESTONES DATA BOX PLOTS	483
Tables 124-129 – Psychiatry Subspecialties MILESTONES DATA BOX PLOTS	487
Table 124 Addiction Medicine (multidisciplinary)	
Table 125 Addiction Psychiatry	
Table 126 Child and Adolescent Psychiatry	
Table 127 Consultation-Liaison Psychiatry	
Table 128 Forensic Psychiatry	
Table 129 Geriatric Psychiatry	
Table 130 – Radiation Oncology MILESTONES DATA BOX PLOTS	506
Table 131 – Diagnostic Radiology MILESTONES DATA BOX PLOTS	510
Tables 132-136 – Diagnostic Radiology Subspecialties MILESTONES DATA BOX PLOTS	514
Table 132 Abdominal Radiology	
Table 133 Musculoskeletal Radiology	
Table 134 Neuroradiology	
Table 135 Nuclear Radiology	
Table 136 Pediatric Radiology	
Table 137 – Interventional Radiology - Independent MILESTONES DATA BOX PLOTS	532
Table 138 – Interventional Radiology - Integrated MILESTONES DATA BOX PLOTS	536
Table 139 – Surgery MILESTONES DATA BOX PLOTS	542

MILESTONES NATIONAL REPORT 2022

Tables 140-143 – Surgery Subspecialties MILESTONES DATA BOX PLOTS	545
Table 140 Complex General Surgical Oncology	
Table 141 Pediatric Surgery	
Table 142 Surgical Critical Care	
Table 143 Vascular Surgery - Independent	
Table 144 – Vascular Surgery - Integrated MILESTONES DATA BOX PLOTS	563
Table 145 – Thoracic Surgery - Independent (Two- and Three-Year Programs) MILESTONES DATA BOX PLOTS	568
Table 146 – Thoracic Surgery - Integrated MILESTONES DATA BOX PLOTS	576
Table 147 – Thoracic Surgery - Integrated Subspecialties MILESTONES DATA BOX PLOTS	580
Table 147 Congenital Cardiac Surgery	
Table 148 – Transitional Year MILESTONES DATA BOX PLOTS	582
Table 149 – Urology MILESTONES DATA BOX PLOTS	586
Tables 150-151 – Urology Subspecialties MILESTONES DATA BOX PLOTS	590
Table 150 Female Pelvic Medicine and Reconstructive Surgery (multidisciplinary)	
Table 151 Pediatric Urology	
Table 152 – Internal Medicine - Pediatrics MILESTONES DATA BOX PLOTS	598

A Note on Specialty and Subspecialty Names

In this report, specialty and subspecialty names align with the way they appear in the specialty-specific Program Requirements and in the Milestones documents; these names may differ from how they appear in the Accreditation Data System and ACGME Data Resource Book.

MILESTONES NATIONAL REPORT 2022

BACKGROUND

The Milestones are intended to be used as a professional development tool to better prepare physicians for a changing health care system by emphasizing a focus on the competencies required of residents and fellows and ensuring they match societal, and patients' needs in a variety of critical ways (Batalden et al. 2002; Ericsson 2007; Hodges 2010; Institute of Medicine 2014; Nasca, Philibert, Brigham, and Flynn 2012).

The Milestones allow for continuous monitoring and quality improvement for GME. Individual programs can focus on making improvements in both curricula and assessments that align with the specific competencies outlined by the Milestones, up to the point of graduation. This will help to ensure that graduates from these programs meet the expected standards of the profession and the goal of unsupervised practice.

Milestones Intended Purpose

Tracking of Milestones data is part of the ACGME's commitment to meeting the responsibility of professional self-regulation, and the expectations for quality and safety from its primary stakeholder: the public (Institute of Medicine 2014; Nasca 2015; Nasca, Philibert, Brigham, and Flynn 2012). The primary purpose of this report is to provide the Milestones data as feedback to help individual GME programs, institutions, and national organizations involved in GME to improve curriculum and assessment practices. The collection of individual residents' and fellows' Milestones data will only be used in aggregate form by the ACGME for quality improvement purposes. The ACGME will continue to collaborate with the American Board of Medical Specialties (ABMS), the American Osteopathic Association (AOA), and the various specialty boards toward ensuring high-quality graduates and maintenance of the public trust.

Using Milestones Data to Provide Useful Feedback to Programs

The ACGME's accreditation model is built on a continuous quality improvement (CQI) framework. The collection, sharing, and interpretation of Milestones data allows for refinement of policies and accreditation standards for effective education and training. These data provide an empirical basis for working with specialty groups and programs that may require guidance to meet the expectations set out in the ACGME's accreditation model and the Institute for Healthcare Improvement's Quadruple Aim (Bodenheimer and Sinsky 2014). In essence, the GME community must work together to ensure residents and fellows are ready for unsupervised practice following graduation, and the Milestones can provide detailed guidance for achieving this goal.

Development of the Milestones

Individual milestones were developed based on subcompetencies within each specialty (Sullivan, Simpson, Cooney, and Beresin 2013). The creation of these detailed developmental markers of progression involved members of the ACGME Review Committees, representatives from the certification boards, program directors, residents and fellows, and representatives from specialty societies. More recently, the Milestones 2.0 Work Groups have included public members. The Milestones were written to cover the six Core Competencies with educational program periods that range from single-year fellowships to residency programs lasting seven years. The Milestones are grounded in important educational developmental theory and research (Batalden et al. 2002; Ericsson 2007; Hodges 2010; McGaghie, Barsuk, and Wayne 2017; Pusic, Boutis, Hatala, and Cook 2015).

To make sense of such a large and complex dataset, program directors and specialty societies are encouraged to assist in interpreting these data, given the rich contextual knowledge offered by these stakeholders. Program directors can assist by considering alternative explanations for the observed patterns presented here, and share this with the wider community, including other program directors within their specialty and the ACGME Milestones team, to ensure the data are interpreted properly, and ultimately fulfill their potential to improve GME.

MILESTONES NATIONAL REPORT 2022

HOW TO USE THESE FINDINGS

As can be seen in the data, there is a wide range of attainment across milestones. This variance is likely due to differences in curriculum and/or assessment practices. This should be viewed as welcome news, as it is a signal the Milestones data are providing useful information to drive CQI in GME. Since the launch of the Milestones initiative in 2013, numerous validity studies have been performed to understand the strengths and weaknesses while informing ongoing improvements (Milestones Bibliography, 2021). Multiple research studies informed the creation of Milestones 2.0 for every specialty. Twenty specialties had implemented Milestones 2.0 in the 2021-2022 academic year, and an additional 18 began using Milestones 2.0 in July 2022. The data in this 2022 report reflect the version of the Milestones used by each specialty during the 2021-2022 academic year.

The table below provides some specific purposes and functions of the Milestones organized by stakeholder groups.

Table 1 – Purpose and Function of Milestones

CONSTITUENCY OR STAKEHOLDER	PURPOSE/FUNCTION
Residents and Fellows	<ul style="list-style-type: none"> • Provide a descriptive, developmental roadmap for education and training within a specialty • Increase transparency of performance requirements • Encourage informed self-directed assessment and self-directed learning • Facilitate better feedback • Facilitate development of individualized learning plans by residents and fellows
Residency and Fellowship Programs	<ul style="list-style-type: none"> • Guide curriculum and assessment tool development and improvements • Provide meaningful framework for the CCC (e.g., help create shared mental model) • Provide more explicit expectations of residents and fellows • Enhance opportunity for early identification of struggling learners • Early identification of advanced learners and the need to continuously challenge them
ACGME and the Public	<ul style="list-style-type: none"> • Accountability – report at an aggregated national level on competency outcomes • Build community for evaluation and research, with focus on CQI
Certification Boards	<ul style="list-style-type: none"> • Enable ongoing research to improve certification processes

MILESTONES NATIONAL REPORT 2022

METHODS

Every six months, the ACGME receives more than 3.6 million Milestones ratings of more than 150,000 learners from residency and fellowship programs in more than 150 specialties and subspecialties across the US. The box plots reported in the following pages summarize these data.

OVERARCHING THEMES

Examining the dataset in terms of gradual progression of competence shows that during the 2021-2022 academic year:

- 1) Generally, across all specialties and all programs, learners show progressive attainment of milestones across time in their program;
- 2) Not residents/fellows reach Level 4, which is an educational goal and *not* a requirement or mandate, by the time of graduation; and,
- 3) Each specialty shows variation in attainment of the specific Milestones.

Research to date suggests the following possible reasons for these findings:

- 1) Meaningful differences in actual performance;
- 2) Differences in the complexity of the Milestones competency language as written for a particular specialty;
- 3) Differences in clinical exposure in specific competencies of some residents/fellows in some programs;
- 4) Variation in scoring by individual raters and CCCs;
- 5) Differences in the quality of assessment methods;
- 6) Differences in the types of assessment methods used to show attainment of a particular milestone;
- 7) Differences in the combinations of assessment tools used in a program of assessment; and,
- 8) Differences in CCC processes and approaches for determining milestone attainment.

Of course, many other factors may be at play, and these are the subject of ongoing research. The data should only be reported in the context of interpretive statements and assumptions relevant to the particular stakeholder group, (i.e., DIOs, program directors, residents/fellows, the public). It is important to remember that the Milestones are designed for use as formative assessments to be used in the spirit of CQI, and that Level 4 is an educational goal and *not* a requirement or mandate. To fully interpret and understand the results of Milestones analyses and validity studies, there must also be full awareness of the consequences, with appropriate diligence in providing context for proper interpretation of any rating result (Hubley and Zumbo 2011).

MILESTONES NATIONAL REPORT 2022

Straight-Lining Ratings

Straight-lining ratings are defined as a string of identical Milestones ratings for an individual learner across all subcompetencies. In the original vision of the ACGME's current accreditation model (a.k.a. "the Next Accreditation System"), it was assumed that performance across subcompetencies would vary due to contextual factors, curricular design, and variability among learner abilities, according to the content of each subcompetency. For example, a learner would not necessarily be expected to have exactly the same ratings for the milestones in patient care, interpersonal and communication skills, and systems-based practice during a given six-month period. Accurate detection of true variation in ratings would theoretically be useful for tailoring specific feedback to each learner.

It is theoretically possible that an individual learner could be assigned identical Milestone ratings across all subcompetencies (e.g., straight-lining for Milestones in Level 4 can be a valid rating pattern for the senior-most residents who, at the time of graduation, have truly achieved Level 4 in all subcompetencies). However, the data show several instances in which the rate of straight-lining is higher than would be expected, and these rates are presented in Table 4.

Method: The rate of straight-lining was calculated as follows: if any resident's or fellow's string of Milestone ratings was identical across all subcompetencies, the resident or fellow was assigned a value of "1;" otherwise, "0." The table provides the percentage of residents or fellows nationally who were assigned a value of "1" (meaning they had received the same rating for all their milestones).

Interpretation: Nationally, the ACGME is working to understand whether this straight-lining effect represents true lack of variation in competence, or if CCCs are simply providing similar ratings across subcompetencies for other reasons, such as a belief that the description of individual milestones for some subcompetencies does not fit with their local setting, or they are otherwise having difficulty obtaining valid and defensible ratings through lack of resources or attention to educational assessment within their programs. If a program notes high rates of straight-lining, it would be important for the program director and CCC to reflect on the causes and whether such a Milestones profile is an accurate assessment of the program's residents or fellows.

While some specialties have adopted the 2.0 version of their Milestones, this transition does not appear to have affected the overall rate of straight-lining. These issues continue to be the subject of ongoing qualitative studies with collaborators from various specialties.

FUTURE DIRECTIONS

The Milestones data show interesting patterns of variation that require further research to understand their full implications. In the meantime, caution should be exercised in how these results are interpreted and communicated to various stakeholders.

Milestones 2.0

In response to the feedback received and research completed to date, the Milestones language has now been revised across most specialties to make it easier for program directors to understand and implement locally. Additionally, Milestones language was harmonized across specialties, especially for the competencies of Professionalism, Interpersonal and Communication Skills, Systems-based Practice, and Practice-based Learning and Improvement (Edgar, Roberts, and Holmboe 2018; Edgar et al. 2018). Most specialties have made the switch to Milestones 2.0 as of July 2022. With the start of the 2023-2024 academic year, a final group of 14 specialties will implement Milestones 2.0.

MILESTONES NATIONAL REPORT 2022

Limitations

While the interpretations and conclusions that can be drawn from the data presented in this report are based on a single point in time (June 2022), trends for stability in the data patterns for academic year-end since June 2014 have recently been examined for the earliest reporting specialties. Most of the Milestones data show signs of stability across this period, which lends greater confidence to the potential interpretations and conclusions that can be drawn from them.

Acknowledgments

The authors wish to thank the program directors for their valuable insights, as well as the various stakeholder groups to whom preliminary versions of these results have been presented over past years. The Milestones staff also owes a great debt of gratitude to the staff in the ACGME's Applications and Data Analysis team for compiling the data and preparing Tables 1 and 2 and the box plots.

Contact Us:

milestones@acgme.org

MILESTONES NATIONAL REPORT 2022

REFERENCES

- Batalden Paul, David Leach, Susan Swing, Hubert Dreyfus, and Stuart Dreyfus. 2002. "General Competencies, and Accreditation in Graduate Medical Education." *Health Affairs* 21: 103-111. doi: 10.1377/hlthaff.21.5.103.
- Bodenheimer, T., and C. Sinsky. 2014. "From Triple to Quadruple Aim: Care of the Patient Requires Care of the Provider." *Annals of Family Medicine* 12 (6): 573-576. doi:10.1370/afm.1713
- Edgar, Laura, Sydney Roberts, Eric S. Holmboe. 2018. "Milestones 2.0: A Step Forward." *Journal of Graduate Medical Education* 10 no. 3 (June): 367-369. doi: 10.4300/JGME-D-18-00372.1. PMID: 29946411; PMCID: PMC6008021.
- Edgar, Laura, Sydney Roberts, Nicholas A. Yaghmour, A. Leep Hunderfund, Stan J. Hamstra, Lisa Conforti, and Eric S. Holmboe. 2018. "Competency Crosswalk: A Multispecialty Review of the Accreditation Council for Graduate Medical Education Milestones Across Four Competency Domains." *Academic Medicine* 9; no. 37, (July):1035-1041. doi: 10.1097/ACM.0000000000002059. PMID: 29166350.
- Ericsson, K. Anders 2007. "An Expert-Performance Perspective of Research on Medical Expertise: The Study of Clinical Performance." *Medical Education* 41 (12): 1124-30. doi: 10.1111/j.1365-2923.2007.02946.x.
- Hodges, B.D. 2010. "A Tea-Steeping or i-Doc Model for Medical Education?" *Academic Medicine* 85 no. 9 (September Supplement): S34-S44.
- Hubley, A.M. and B.D. Zumbo. 2011. "Validity and the Consequences of Test Interpretation and Use." *Social Indicators Research* 103: 219-230.
- Institute of Medicine (IOM). 2014. Graduate Medical Education that Meets the Nation's Health Needs. Washington, DC: The National Academies Press.
- McGaghie, W.C., J.H. Barsuk, and D.B. Wayne. 2017. "The Promise and Challenge of Mastery Learning." *Advances in Medical Education and Practice* 22; no. 8, (June): 393-394. doi: 10.2147/AMEP.S141073. PMID: 28790876; PMCID: PMC5489053.
- Messick S. 1989. "Validity." In *Educational Measurement, Third Edition*, edited by R.L. Linn, 13-103. New York: American Council on Education and Macmillan.
- Milestones Bibliography December 2020. Accessed at: <https://www.acgme.org/Portals/0/PDFs/Milestones/Milestones%20Bibliography%20-%20December%202020.pdf?ver=2021-02-03-155441-980>
- Nasca, Thomas J. 2015. "Professionalism and Its Implications for Governance and Accountability of Graduate Medical Education in the United States." *Journal of the American Medical Association* 313 (18): 1801-2.
- Nasca, Thomas J., Ingrid Philibert, Timothy Brigham, and T.C. Flynn. 2012. "The Next Accreditation System: Rationale and Benefits." *New England Journal of Medicine* 366: 1051-1056.5.
- Pusic, M.V., K. Boutis, R. Hatala, and D.A. Cook. 2015. "Learning Curves in Health Professions Education." *Academic Medicine* 90, no. 8 (August): 1034-42. doi: 10.1097/ACM.0000000000000681. PMID: 25806621.
- Sullivan, G., D. Simpson, T. Cooney, and E. Beresin. 2013. "A Milestone in the Milestones Movement: The *JGME* Milestones Supplement." *Journal of Graduate Medical Education* (March Supplement): 1-4.

Table 2 – Number of Subcompetencies by Specialty

Specialty/Subspecialty Name	Number of Subcompetencies						
	Total	PC	MK	SBP	PBLI	PROF	ICS
Allergy and Immunology	19	4	3	4	2	3	3
Anesthesiology	23	10	2	3	2	3	3
Adult Cardiothoracic Anesthesiology	15	2	4	3	2	3	1
Critical Care Medicine (multidisciplinary)	16	5	2	3	2	3	1
Obstetric Anesthesiology	15	4	2	3	2	3	1
Pain Medicine (multidisciplinary)	24	6	3	4	4	4	3
Pediatric Anesthesiology	14	3	2	3	2	3	1
Regional Anesthesiology and Acute Pain Medicine	17	3	3	3	2	3	3
Colon and Rectal Surgery	27	13	2	3	2	4	3
Dermatology	21	8	2	3	2	3	3
Dermatopathology (multidisciplinary)	12	2	2	2	2	2	2
Micrographic Surgery and Dermatologic Oncology	14	4	2	2	2	2	2
Emergency Medicine	22	8	2	4	2	3	3
Emergency Medical Services	14	5	1	2	2	2	2
Medical Toxicology (multidisciplinary)	14	3	3	2	2	2	2
Pediatric Emergency Medicine (multidisciplinary)	23	11	1	2	1	5	3
Sports Medicine (multidisciplinary)	14	3	3	2	2	2	2
Undersea and Hyperbaric Medicine (multidisciplinary)	17	4	6	2	1	2	2
Family Medicine	19	5	2	4	2	3	3
Clinical Informatics (multidisciplinary)	20	6	2	3	2	5	2
Geriatric Medicine (multidisciplinary)	22	6	2	4	2	4	4
Hospice and Palliative Medicine (multidisciplinary)	20	4	3	4	2	3	4
Sports Medicine (multidisciplinary)	14	3	3	2	2	2	2
Internal Medicine	21	6	3	3	2	4	3
Adult Congenital Heart Disease	24	6	3	4	4	4	3
Advanced Heart Failure and Transplant Cardiology	21	5	5	3	2	3	3
Cardiovascular Disease	17	4	2	3	2	3	3
Clinical Cardiac Electrophysiology	24	9	4	3	2	3	3
Clinical Informatics (multidisciplinary)	20	6	2	3	2	5	2
Critical Care Medicine	19	4	2	4	2	3	4
Endocrinology, Diabetes, and Metabolism	19	6	2	3	2	3	3
Gastroenterology	17	4	2	3	2	3	3
Gastroenterology (Dual Gastroenterology/Transplant Hepatology Pathway)	22	7	4	3	2	3	3
Geriatric Medicine (multidisciplinary)	22	6	2	4	2	4	4
Hematology and Medical Oncology	22	5	4	5	2	3	3
Infectious Disease	23	3	6	5	2	4	3
Interventional Cardiology	17	3	3	3	2	3	3
Nephrology	22	7	3	4	2	3	3
Medical Oncology	21	5	3	5	2	3	3
Pulmonary Disease	19	4	2	4	2	3	4
Pulmonary Disease and Critical Care Medicine	20	5	2	4	2	3	4
Rheumatology	21	6	3	3	2	4	3

Table 2 – Number of Subcompetencies by Specialty

Specialty/Subspecialty Name	Number of Subcompetencies						
	Total	PC	MK	SBP	PBLI	PROF	ICS
Sleep Medicine (multidisciplinary)	18	4	2	3	2	3	4
Transplant Hepatology	16	3	2	3	2	3	3
Medical Genetics and Genomics	17	3	3	3	2	3	3
Clinical Biochemical Genetics	19	4	2	5	2	3	3
Laboratory Genetics and Genomics	19	4	2	5	2	3	3
Medical Biochemical Genetics	16	3	3	3	2	3	2
Molecular Genetic Pathology (multidisciplinary)	22	3	4	6	3	3	3
Neurological Surgery	20	8	2	3	3	2	2
Neurology	27	12	2	4	2	3	4
Clinical Neurophysiology	21	7	6	2	2	2	2
Epilepsy	18	6	3	3	2	2	2
Neurodevelopmental Disabilities	32	10	5	6	2	5	4
Neuromuscular Medicine (multidisciplinary)	21	9	4	2	2	2	2
Vascular Neurology	25	5	7	4	2	3	4
Child Neurology	26	10	4	3	2	3	4
Nuclear Medicine	19	5	7	2	2	1	2
Obstetrics and Gynecology	28	11	7	2	2	3	3
Female Pelvic Medicine and Reconstructive Surgery (multidisciplinary)	23	7	8	3	2	1	2
Gynecologic Oncology	20	5	7	2	2	2	2
Maternal-Fetal Medicine	18	4	5	2	3	2	2
Reproductive Endocrinology and Infertility	15	3	3	2	3	2	2
Ophthalmology	20	6	3	3	2	3	3
Orthopaedic Surgery	20	7	2	3	2	3	3
Adult Reconstructive Orthopaedic Surgery	23	7	7	3	2	2	2
Foot and Ankle Orthopaedic Surgery	24	8	8	3	1	2	2
Hand Surgery (multidisciplinary)	18	7	7	1	1	1	1
Musculoskeletal Oncology	19	5	5	3	2	2	2
Orthopaedic Sports Medicine	14	3	3	2	2	2	2
Orthopaedic Surgery Of The Spine	15	4	4	1	2	2	2
Orthopaedic Trauma	18	5	5	2	2	2	2
Pediatric Orthopaedic Surgery	21	6	6	3	2	2	2
Osteopathic Neuromusculoskeletal Medicine	15	4	2	2	2	3	2
Otolaryngology - Head and Neck Surgery	17	8	4	2	1	1	1
Neurotology	13	3	2	2	2	2	2
Pediatric Otolaryngology	13	3	2	2	2	2	2
Pathology (Anatomic and Clinical)	21	6	2	5	2	3	3
Blood Banking/Transfusion Medicine	23	4	6	5	2	3	3
Clinical Informatics (multidisciplinary)	20	6	2	3	2	5	2
Cytopathology	21	6	2	5	2	3	3
Forensic Pathology	19	2	3	5	2	3	4
Hematopathology	23	4	6	5	2	3	3
Medical Microbiology	21	3	4	6	2	3	3

Table 2 – Number of Subcompetencies by Specialty

Specialty/Subspecialty Name	Number of Subcompetencies						
	Total	PC	MK	SBP	PBLI	PROF	ICS
Neuropathology	20	4	3	5	2	3	3
Pediatric Pathology	19	4	2	5	2	3	3
Selective Pathology (Focused Anatomic)	19	4	2	5	2	3	3
Selective Pathology (Surgical)	19	4	2	5	2	3	3
Pediatrics	22	5	2	6	2	4	3
Adolescent Medicine	21	4	1	5	4	4	3
Child Abuse Pediatrics	21	4	1	5	4	4	3
Clinical Informatics (multidisciplinary)	20	6	2	3	2	5	2
Developmental-Behavioral Pediatrics	21	4	1	5	4	4	3
Neonatal-Perinatal Medicine	21	4	1	5	4	4	3
Pediatric Cardiology	21	4	1	5	4	4	3
Pediatric Critical Care Medicine	21	4	1	5	4	4	3
Pediatric Emergency Medicine (multidisciplinary)	23	11	1	2	1	5	3
Pediatric Endocrinology	21	4	1	5	4	4	3
Pediatric Gastroenterology	21	4	1	5	4	4	3
Pediatric Hematology/Oncology	21	4	1	5	4	4	3
Pediatric Hospital Medicine	21	4	1	5	4	4	3
Pediatric Infectious Diseases	21	4	1	5	4	4	3
Pediatric Nephrology	21	4	1	5	4	4	3
Pediatric Pulmonology	21	4	1	5	4	4	3
Pediatric Rheumatology	21	4	1	5	4	4	3
Pediatric Transplant Hepatology	21	4	1	5	4	4	3
Sports Medicine (multidisciplinary)	14	3	3	2	2	2	2
Physical Medicine and Rehabilitation	24	8	2	4	2	5	3
Brain Injury Medicine (multidisciplinary)	23	6	3	4	2	5	3
Pediatric Rehabilitation Medicine	24	8	2	4	2	5	3
Spinal Cord Injury Medicine	23	5	3	4	2	5	4
Sports Medicine (multidisciplinary)	14	3	3	2	2	2	2
Plastic Surgery - Independent	36	14	14	3	2	2	1
Plastic Surgery - Integrated	36	14	14	3	2	2	1
Hand Surgery (multidisciplinary)	18	7	7	1	1	1	1
Preventive Medicine (Aerospace Medicine)	20	6	2	4	2	3	3
Preventive Medicine (Occupational Medicine)	21	6	3	4	2	3	3
Preventive Medicine (Public Health and General Preventive Medicine)	23	12	3	3	1	2	2
Psychiatry	21	6	4	3	2	3	3
Addiction Medicine (multidisciplinary)	16	2	3	3	2	3	3
Addiction Psychiatry	16	3	3	4	2	2	2
Child and Adolescent Psychiatry	21	5	6	4	2	2	2
Forensic Psychiatry	13	2	2	3	2	2	2
Geriatric Psychiatry	16	3	3	4	2	2	2
Consultation-Liaison Psychiatry	15	2	3	4	2	2	2
Radiation Oncology	22	11	2	3	2	2	2
Diagnostic Radiology	24	4	4	8	2	3	3

Table 2 – Number of Subcompetencies by Specialty

Specialty/Subspecialty Name	Number of Subcompetencies						
	Total	PC	MK	SBP	PBLI	PROF	ICS
Abdominal Radiology	13	3	2	2	2	2	2
Musculoskeletal Radiology	22	3	3	8	2	3	3
Neuroradiology	21	4	2	7	2	3	3
Nuclear Radiology	20	3	3	6	2	3	3
Pediatric Radiology	14	3	3	2	2	1	3
Interventional Radiology - Independent	24	5	3	7	2	4	3
Interventional Radiology - Integrated	31	6	6	10	2	4	3
Surgery	18	4	2	3	2	4	3
Complex General Surgical Oncology	23	7	4	3	3	3	3
Pediatric Surgery	22	9	2	3	2	4	2
Surgical Critical Care	25	10	3	4	2	3	3
Vascular Surgery - Independent	28	8	5	6	2	4	3
Vascular Surgery - Integrated	28	8	5	6	2	4	3
Thoracic Surgery - Independent	23	8	3	3	2	4	3
Congenital Cardiac Surgery	9	2	3	1	1	1	1
Thoracic Surgery - Integrated	24	9	3	3	2	4	3
Urology	20	6	2	3	2	3	4
Female Pelvic Medicine and Reconstructive Surgery (multidisciplinary)	23	7	8	3	2	1	2
Pediatric Urology	21	6	3	3	2	3	4
Transitional Year	19	6	2	3	2	3	3
Internal Medicine - Pediatrics	43	11	5	9	4	8	6

Note:

PC - Patient Care and Procedural Skills

MK - Medical Knowledge

SBP - Systems-Based Practice

PBLI - Practice-Based Learning and Improvement

PROF - Professionalism

ICS - Interpersonal and Communication Skills

Table 3 – Number of Residents/Fellows by Year in Program

Specialty/Subspecialty Name	Total	Resident Year						
		1	2	3	4	5	6	7
Allergy and Immunology	323	158	165					
Anesthesiology	7,103	1,461	1,938	1,889	1,815			
Adult Cardiothoracic Anesthesiology	244	244						
Critical Care Medicine (multidisciplinary)	208	208						
Obstetric Anesthesiology	57	57						
Pain Medicine (multidisciplinary)	419	419						
Pediatric Anesthesiology	209	209						
Regional Anesthesiology and Acute Pain Medicine	89	89						
Colon and Rectal Surgery	108	108						
Dermatology	1,540	520	511	509				
Dermatopathology (multidisciplinary)	71	71						
Micrographic Surgery and Dermatologic Oncology	89	89						
Emergency Medicine (Three-Year Programs)	6,392	2,268	2,135	1,989				
Emergency Medicine (Four-Year Programs)	2,661	680	666	667	648			
Emergency Medical Services	107	107						
Medical Toxicology (multidisciplinary)	81	38	43					
Pediatric Emergency Medicine (multidisciplinary)	140	58	45	37				
Sports Medicine (multidisciplinary)	18	18						
Undersea and Hyperbaric Medicine (multidisciplinary)	13	13						
Family Medicine	14,345	4,962	4,810	4,573				
Clinical Informatics (multidisciplinary)	19	11	8					
Geriatric Medicine (multidisciplinary)	50	50						
Hospice and Palliative Medicine (multidisciplinary)	459	459						
Sports Medicine (multidisciplinary)	284	284						
Internal Medicine	31,048	12,090	9,722	9,236				
Adult Congenital Heart Disease	34	17	17					
Advanced Heart Failure and Transplant Cardiology	103	103						
Cardiovascular Disease	3,322	1,149	1,101	1,072				
Clinical Cardiac Electrophysiology	309	174	135					
Clinical Informatics (multidisciplinary)	50	31	19					
Critical Care Medicine	322	186	136					
Endocrinology, Diabetes, and Metabolism	702	372	330					
Gastroenterology	1,893	662	631	600				
Gastroenterology (Gastroenterology/Transplant Hepatology Pathway)	20	1	8	11				
Geriatric Medicine (multidisciplinary)	298	298						
Hematology and Medical Oncology	1,976	689	681	606				
Infectious Disease	803	427	376					
Interventional Cardiology	359	359						
Nephrology	868	449	419					
Medical Oncology	34	18	16					
Pulmonary Disease	68	34	34					

Table 3 – Number of Residents/Fellows by Year in Program

Specialty/Subspecialty Name	Total	Resident Year						
		1	2	3	4	5	6	7
Pulmonary Disease and Critical Care Medicine	2,177	796	714	667				
Rheumatology	535	269	266					
Sleep Medicine (multidisciplinary)	205	205						
Transplant Hepatology	48	48						
Medical Genetics and Genomics	73	41	32					
Clinical Biochemical Genetics	13	8	5					
Laboratory Genetics and Genomics	66	31	35					
Medical Biochemical Genetics	17	17						
Molecular Genetic Pathology (multidisciplinary)	59	59						
Neurological Surgery	1,582	237	239	232	212	218	222	222
Neurology	3,385	659	965	911	850			
Clinical Neurophysiology	154	154						
Epilepsy	158	158						
Neurodevelopmental Disabilities	27	7	8	7	5			
Neuromuscular Medicine (multidisciplinary)	73	73						
Vascular Neurology	154	154						
Child Neurology	464	174	148	142				
Nuclear Medicine	76	38	20	18				
Obstetrics and Gynecology	5,888	1,528	1,496	1,441	1,423			
Female Pelvic Medicine and Reconstructive Surgery (multidisciplinary)	152	53	48	51				
Gynecologic Oncology	229	81	75	73				
Maternal-Fetal Medicine	403	142	130	131				
Reproductive Endocrinology and Infertility	172	61	55	56				
Ophthalmology	1,693	171	519	507	496			
Orthopaedic Surgery	4,470	909	905	889	891	876		
Adult Reconstructive Orthopaedic Surgery	53	53						
Foot and Ankle Orthopaedic Surgery	16	16						
Hand Surgery (multidisciplinary)	156	156						
Musculoskeletal Oncology	16	16						
Orthopaedic Sports Medicine	216	216						
Orthopaedic Surgery Of The Spine	25	25						
Orthopaedic Trauma	20	20						
Pediatric Orthopaedic Surgery	35	35						
Osteopathic Neuromusculoskeletal Medicine	83	16	22	45				
Otolaryngology - Head and Neck Surgery	1,764	362	367	349	342	344		
Neurotology	37	20	17					
Pediatric Otolaryngology	42	42						
Pathology (Anatomic and Clinical)	2,347	628	611	594	514			
Blood Banking/Transfusion Medicine	45	45						
Clinical Informatics (multidisciplinary)	21	13	8					
Cytopathology	124	124						
Forensic Pathology	59	59						

Table 3 – Number of Residents/Fellows by Year in Program

Specialty/Subspecialty Name	Resident Year							
	Total	1	2	3	4	5	6	7
Hematopathology	128	128						
Medical Microbiology	12	12						
Neuropathology	53	31	22					
Pediatric Pathology	22	22						
Selective Pathology (Focused Anatomic)	104	104						
Selective Pathology (Surgical)	82	82						
Pediatrics	9,510	3,286	3,209	3,015				
Adolescent Medicine	93	28	32	33				
Child Abuse Pediatrics	50	22	14	14				
Clinical Informatics (multidisciplinary)	29	15	14					
Developmental-Behavioral Pediatrics	113	46	30	37				
Neonatal-Perinatal Medicine	803	299	252	252				
Pediatric Cardiology	483	165	161	157				
Pediatric Critical Care Medicine	596	210	202	184				
Pediatric Emergency Medicine (multidisciplinary)	446	154	150	142				
Pediatric Endocrinology	234	85	86	63				
Pediatric Gastroenterology	332	112	110	110				
Pediatric Hematology/Oncology	487	167	158	162				
Pediatric Hospital Medicine	165	92	73					
Pediatric Infectious Diseases	184	60	68	56				
Pediatric Nephrology	134	62	42	30				
Pediatric Pulmonology	186	69	59	58				
Pediatric Rheumatology	103	41	36	26				
Pediatric Transplant Hepatology	16	16						
Sports Medicine (multidisciplinary)	28	28						
Physical Medicine and Rehabilitation	1,580	169	489	468	454			
Brain Injury Medicine (multidisciplinary)	26	26						
Spinal Cord Injury Medicine	23	23						
Pediatric Rehabilitation Medicine	31	20	11					
Sports Medicine (multidisciplinary)	40	40						
Plastic Surgery - Independent	203	68	66	69				
Plastic Surgery - Integrated	1,061	195	181	182	177	169	157	
Hand Surgery (multidisciplinary)	25	25						
Preventive Medicine (Aerospace Medicine)	48	24	24					
Preventive Medicine (Occupational Medicine)	114	66	48					
Preventive Medicine (Public Health and General Preventive Medicine)	175	98	77					
Psychiatry	7,370	2,064	2,022	1,910	1,374			
Addiction Medicine (multidisciplinary)	182	182						
Addiction Psychiatry	87	87						
Child and Adolescent Psychiatry	963	512	451					
Forensic Psychiatry	91	91						
Geriatric Psychiatry	59	59						

Table 3 – Number of Residents/Fellows by Year in Program

Specialty/Subspecialty Name	Resident Year							
	Total	1	2	3	4	5	6	7
Consultation-Liaison Psychiatry	93	93						
Radiation Oncology	763	186	197	186	194			
Diagnostic Radiology	4,433	1,135	1,123	1,102	1,073			
Abdominal Radiology	52	52						
Musculoskeletal Radiology	39	39						
Neuroradiology	296	296						
Nuclear Radiology	14	14						
Pediatric Radiology	53	53						
Interventional Radiology - Independent	207	127	80					
Interventional Radiology - Integrated	650	148	153	132	133	84		
Surgery	9,333	2,860	1,832	1,631	1,533	1,477		
Complex General Surgical Oncology	124	62	62					
Pediatric Surgery	86	47	39					
Surgical Critical Care	337	337						
Vascular Surgery - Independent	267	138	129					
Vascular Surgery - Integrated	363	81	81	71	66	64		
Thoracic Surgery - Independent (Two-Year Programs)	151	78	73					
Thoracic Surgery - Independent (Three-Year Programs)	100	34	35	31				
Congenital Cardiac Surgery	13	13						
Thoracic Surgery - Integrated	231	47	41	43	36	32	32	
Urology	1,791	373	370	366	348	334		
Female Pelvic Medicine and Reconstructive Surgery (multidisciplinary)	37	15	15	7				
Pediatric Urology	29	18	11					
Transitional Year	1,780	1,780						
Internal Medicine - Pediatrics	1,534	390	389	377	378			

Table 4 – Rate of Straight-Lining (June 2022)

Specialty/Subspecialty Name	Number of Subcomp	Yr 1	Yr 2	Yr 3	Yr 4	Yr 5	Yr 6	Yr 7
Allergy and Immunology (323)	19	7.6%	13.3%					
Anesthesiology (7,103)	23	31.2%	23.6%	24.4%	30.9%			
Adult Cardiothoracic Anesthesiology (244)	15	29.5%						
Critical Care Medicine (multidisciplinary) (208)	16	15.9%						
Obstetric Anesthesiology (57)	15	12.3%						
Pain Medicine (multidisciplinary) (419)	24	29.3%						
Pediatric Anesthesiology (209)	14	20.1%						
Regional Anesthesiology and Acute Pain Medicine (89)	17	39.3%						
Colon and Rectal Surgery (108)	27	12.0%						
Dermatology (1,540)	21	13.6%	13.8%	18.9%				
Dermatopathology (multidisciplinary) (71)	12	18.3%						
Micrographic Surgery and Dermatologic Oncology (89)	14	22.5%						
Emergency Medicine (Three-Year Programs) (6,392)	22	12.7%	14.1%	23.2%				
Emergency Medicine (Four-Year Programs) (2,661)	22	12.6%	12.8%	14.4%	20.7%			
Emergency Medical Services (107)	14	6.5%						
Medical Toxicology (multidisciplinary) (81)	14	5.3%	11.9%					
Pediatric Emergency Medicine (multidisciplinary) (140)	23	0.0%	6.8%	11.4%				
Sports Medicine (multidisciplinary) (18)	14	11.8%						
Undersea and Hyperbaric Medicine (multidisciplinary) (13)	17	23.1%						
Family Medicine (14,345)	19	7.3%	6.9%	9.7%				
Clinical Informatics (multidisciplinary) (19)	20	0.0%	0.0%					
Geriatric Medicine (multidisciplinary) (50)	22	6.0%						
Hospice and Palliative Medicine (multidisciplinary) (459)	20	14.4%						
Sports Medicine (multidisciplinary) (284)	14	10.6%						
Internal Medicine (31,048)	21	15.2%	14.6%	23.9%				
Adult Congenital Heart Disease (34)	24	6.3%	13.3%					
Advanced Heart Failure and Transplant Cardiology (103)	21	14.6%						
Cardiovascular Disease (3,322)	17	19.1%	22.7%	32.1%				
Clinical Cardiac Electrophysiology (309)	24	13.9%	23.9%					
Clinical Informatics (multidisciplinary) (50)	20	0.0%	0.0%					
Critical Care Medicine (322)	19	8.6%	14.7%					
Endocrinology, Diabetes, and Metabolism (702)	19	4.6%	12.5%					
Gastroenterology (1,893)	17	10.9%	14.0%	29.5%				
Gastroenterology (Dual Gastroenterology/Transplant Hepatology Pathway) (20)	22	0.0%	12.5%	0.0%				
Geriatric Medicine (multidisciplinary) (298)	22	8.7%						
Hematology and Medical Oncology (1,976)	22	12.8%	14.4%	26.1%				
Infectious Disease (803)	23	5.2%	14.1%					

Table 4 – Rate of Straight-Lining (June 2022)

Specialty/Subspecialty Name	Number of Subcomp	Yr 1	Yr 2	Yr 3	Yr 4	Yr 5	Yr 6	Yr 7
Interventional Cardiology (359)	17	33.7%						
Nephrology (868)	22	6.0%	16.0%					
Medical Oncology (34)	21	5.6%	25.0%					
Pulmonary Disease (68)	19	11.8%	17.6%					
Pulmonary Disease and Critical Care Medicine (2,177)	20	13.7%	15.0%	23.8%				
Rheumatology (535)	21	7.1%	15.6%					
Sleep Medicine (multidisciplinary) (205)	18	20.5%						
Transplant Hepatology (48)	16	22.9%						
Medical Genetics and Genomics (73)	17	7.3%	12.5%					
Clinical Biochemical Genetics (13)	19	0.0%	0.0%					
Laboratory Genetics and Genomics (66)	19	6.5%	2.9%					
Medical Biochemical Genetics (17)	16	17.6%						
Molecular Genetic Pathology (multidisciplinary) (59)	22	20.3%						
Neurological Surgery (1,582)	20	11.4%	7.1%	7.8%	8.1%	7.3%	9.0%	13.1%
Neurology (3,385)	27	6.7%	4.2%	6.0%	13.5%			
Clinical Neurophysiology (154)	21	2.0%						
Epilepsy (158)	18	13.3%						
Neurodevelopmental Disabilities (27)	32	0.0%	0.0%	0.0%	0.0%			
Neuromuscular Medicine (multidisciplinary) (73)	21	17.8%						
Vascular Neurology (154)	25	12.5%						
Child Neurology (464)	26	3.4%	5.4%	9.9%				
Nuclear Medicine (76)	19	14.3%	5.0%	16.7%				
Obstetrics and Gynecology (5,888)	28	5.0%	3.6%	4.5%	17.0%			
Female Pelvic Medicine and Reconstructive Surgery (multidisciplinary) (152)	23	0.0%	0.0%	5.9%				
Gynecologic Oncology (229)	20	0.0%	0.0%	5.5%				
Maternal-Fetal Medicine (403)	18	0.0%	1.5%	6.1%				
Reproductive Endocrinology and Infertility (172)	15	6.7%	3.6%	7.1%				
Ophthalmology (Three-Year Programs) (946)	20		7.9%	13.8%	22.1%			
Ophthalmology (Four-Year Programs) (747)	20	21.5%	12.9%	18.0%	16.3%			
Orthopaedic Surgery (4,470)	20	18.2%	18.0%	20.5%	26.0%	32.3%		
Adult Reconstructive Orthopaedic Surgery (53)	23	13.5%						
Foot and Ankle Orthopaedic Surgery (16)	24	43.8%						
Hand Surgery (multidisciplinary) (156)	18	21.8%						
Musculoskeletal Oncology (16)	19	43.8%						
Orthopaedic Sports Medicine (216)	14	36.1%						
Orthopaedic Surgery Of The Spine (25)	15	24.0%						
Orthopaedic Trauma (20)	18	50.0%						
Pediatric Orthopaedic Surgery (35)	21	17.1%						
Osteopathic Neuromusculoskeletal Medicine (83)	15	0.0%	4.5%	13.3%				
Otolaryngology - Head and Neck Surgery (1,764)	17	12.4%	7.1%	6.0%	9.4%	14.2%		
Neurotology (37)	13	15.0%	17.6%					
Pediatric Otolaryngology (42)	13	9.8%						

Table 4 – Rate of Straight-Lining (June 2022)

Specialty/Subspecialty Name	Number of Subcomp	Yr 1	Yr 2	Yr 3	Yr 4	Yr 5	Yr 6	Yr 7
Pathology (Anatomic and Clinical) (2,347)	21	9.7%	9.5%	9.1%	19.8%			
Blood Banking/Transfusion Medicine (45)	23	2.2%						
Clinical Informatics (multidisciplinary) (21)	20	0.0%	0.0%					
Cytopathology (124)	21	12.9%						
Forensic Pathology (59)	19	0.0%						
Hematopathology (128)	23	10.9%						
Medical Microbiology (12)	21	0.0%						
Neuropathology (53)	20	3.2%	13.6%					
Pediatric Pathology (22)	19	18.2%						
Selective Pathology (Focused Anatomic) (104)	19	18.3%						
Selective Pathology (Surgical) (82)	19	16.9%						
Pediatrics (9,510)	22	4.5%	4.6%	7.3%				
Adolescent Medicine (93)	21	0.0%	0.0%	15.2%				
Child Abuse Pediatrics (50)	21	4.5%	7.1%	0.0%				
Clinical Informatics (multidisciplinary) (29)	20	13.3%	0.0%					
Developmental-Behavioral Pediatrics (113)	21	0.0%	3.3%	2.7%				
Neonatal-Perinatal Medicine (803)	21	3.0%	3.6%	6.0%				
Pediatric Cardiology (483)	21	3.6%	6.8%	8.9%				
Pediatric Critical Care Medicine (596)	21	2.9%	5.4%	11.4%				
Pediatric Emergency Medicine (multidisciplinary) (446)	23	3.2%	3.3%	4.9%				
Pediatric Endocrinology (234)	21	4.8%	7.1%	9.7%				
Pediatric Gastroenterology (332)	21	7.1%	9.1%	18.2%				
Pediatric Hematology/Oncology (487)	21	8.4%	5.7%	6.8%				
Pediatric Hospital Medicine (165)	21	0.0%	1.4%					
Pediatric Infectious Diseases (184)	21	3.3%	8.8%	3.6%				
Pediatric Nephrology (134)	21	3.2%	9.5%	10.0%				
Pediatric Pulmonology (186)	21	4.5%	3.6%	16.4%				
Pediatric Rheumatology (103)	21	4.9%	11.1%	15.4%				
Pediatric Transplant Hepatology (16)	21	0.0%						
Sports Medicine (multidisciplinary) (28)	14	10.7%						
Physical Medicine and Rehabilitation (1,580)	24	11.8%	6.8%	11.6%	24.9%			
Brain Injury Medicine (multidisciplinary) (26)	23	0.0%						
Pediatric Rehabilitation Medicine (31)	24	0.0%	0.0%					
Spinal Cord Injury Medicine (23)	23	4.3%						
Sports Medicine (multidisciplinary) (40)	14	10.8%						
Plastic Surgery - Independent (203)	36	1.5%	6.1%	14.5%				
Plastic Surgery - Integrated (1,061)	36	11.3%	9.4%	8.2%	10.7%	14.8%	17.8%	
Hand Surgery (multidisciplinary) (25)	18	13.0%						
Preventative Medicine (Aerospace Medicine) (48)	20	0.0%	12.5%					
Preventive Medicine (Occupational Medicine) (114)	21	0.0%	2.1%					
Preventive Medicine (Public Health and General Preventive Medicine) (175)	23	1.0%	1.3%					
Psychiatry (7,370)	21	10.9%	11.1%	13.9%	16.2%			

Table 4 – Rate of Straight-Lining (June 2022)

Specialty/Subspecialty Name	Number of Subcomp	Yr 1	Yr 2	Yr 3	Yr 4	Yr 5	Yr 6	Yr 7
Addiction Medicine (multidisciplinary) (182)	16	9.9%						
Addiction Psychiatry (87)	16	11.5%						
Child and Adolescent Psychiatry (963)	21	2.2%	7.8%					
Forensic Psychiatry (91)	13	11.0%						
Geriatric Psychiatry (59)	16	15.3%						
Consultation-Liaison Psychiatry (93)	15	17.2%						
Radiation Oncology (763)	22	6.5%	11.7%	9.7%	22.7%			
Diagnostic Radiology (4,433)	24	35.9%	29.4%	30.6%	39.1%			
Abdominal Radiology (52)	13	38.5%						
Musculoskeletal Radiology (39)	22	17.9%						
Neuroradiology (296)	21	16.2%						
Nuclear Radiology (14)	20	28.6%						
Pediatric Radiology (53)	14	30.8%						
Interventional Radiology - Independent (207)	24	27.6%	22.5%					
Interventional Radiology - Integrated (650)	31	26.4%	24.2%	25.0%	18.8%	22.6%		
Surgery (9,333)	18	23.4%	17.5%	16.9%	19.0%	26.4%		
Complex General Surgical Oncology (124)	23	9.7%	24.2%					
Pediatric Surgery (86)	22	6.4%	2.6%					
Surgical Critical Care (337)	25	13.1%						
Vascular Surgery - Independent (267)	28	5.8%	24.8%					
Vascular Surgery - Integrated (363)	28	19.8%	14.8%	15.5%	18.2%	37.5%		
Thoracic Surgery- Independent (Two-Year Programs) (151)	23	1.3%	19.2%					
Thoracic Surgery - Independent (Three-Year Programs) (100)	23	0.0%	2.9%	9.7%				
Congenital Cardiac Surgery (13)	9	8.3%						
Thoracic Surgery - Integrated (231)	24	14.9%	12.2%	7.0%	11.1%	3.1%	25.0%	
Urology (1,791)	20	16.9%	12.2%	9.6%	14.7%	24.6%		
Female Pelvic Medicine and Reconstructive Surgery (multidisciplinary) (37)	23	6.7%	13.3%	0.0%				
Pediatric Urology (29)	21	5.6%	0.0%					
Transitional Year (1,780)	19	15.1%						

Note: The following specialties and subspecialties do not contain data and are not included within the data report due to being a newly designated program or containing an insufficient number of learners.

- Addiction Medicine (multidisciplinary, Internal Medicine)
- Brain Injury Medicine (multidisciplinary, Neurology)
- Clinical Informatics (multidisciplinary, Anesthesiology)
- Clinical Informatics (multidisciplinary, Emergency Medicine)
- Craniofacial Surgery
- Endovascular Surgical Neuroradiology (multidisciplinary, Neurological Surgery)
- Endovascular Surgical Neuroradiology (multidisciplinary, Neurology)

- Endovascular Surgical Neuroradiology (multidisciplinary, Radiology)
- Hand Surgery (multidisciplinary, Surgery)
- Hematology
- Medical Toxicology (multidisciplinary, Preventive Medicine)
- Neurocritical Care (multidisciplinary, Neurological Surgery)
- Neurocritical Care (multidisciplinary, Neurology)
- Neuromuscular Medicine (multidisciplinary, Physical Medicine and Rehabilitation)
- Ophthalmic Plastic and Reconstructive Surgery
- Pediatric Cardiothoracic Anesthesiology
- Selective Pathology (Clinical)
- Undersea and Hyperbaric Medicine (multidisciplinary, Preventive Medicine)

FIGURE 1: KEY TO BOX PLOTS

Box plots provide a rigorous and robust way to display complex data, such as for the Milestones. The components of the box plots used for the Milestones are shown below.

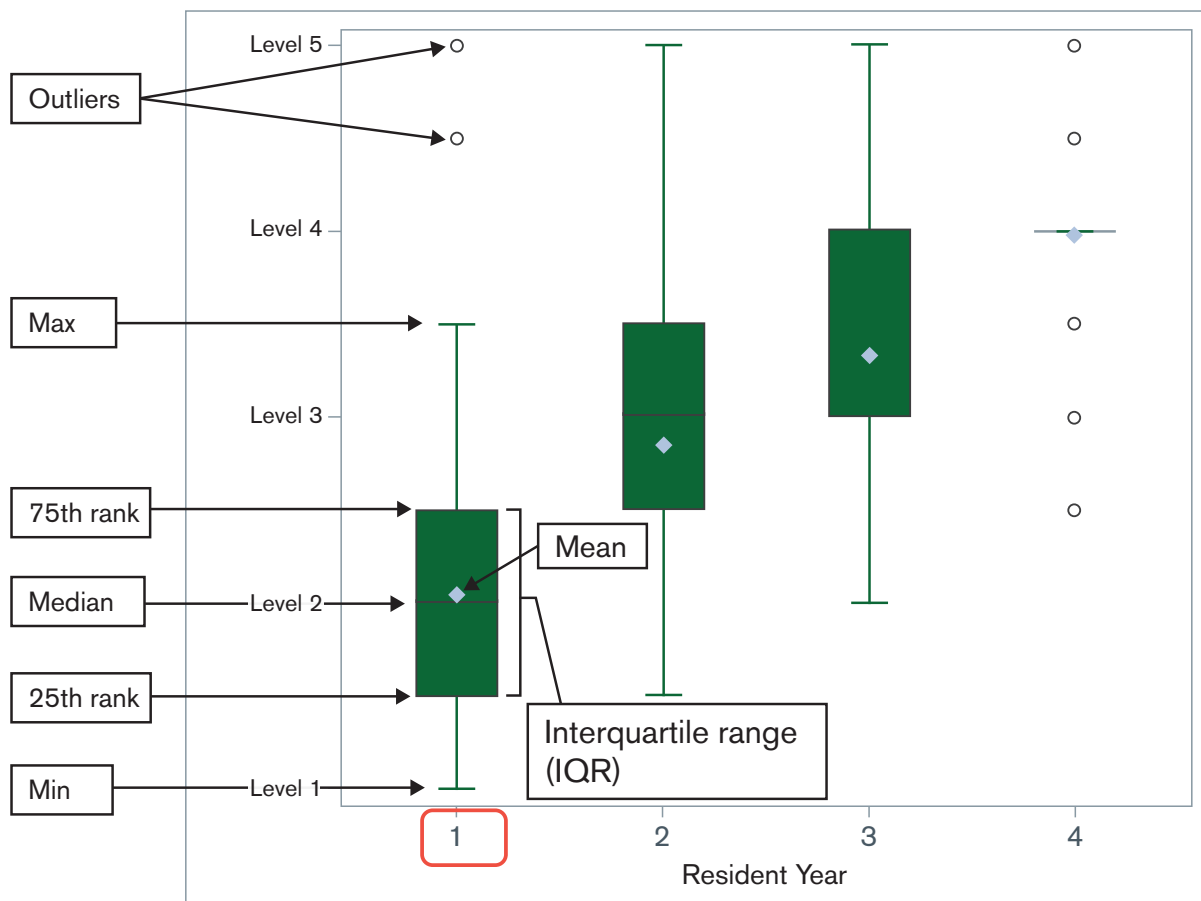

As seen in this diagram, the median Milestones level for each resident year is represented by the horizontal line, bounded by the 25th and 75th rank of Milestone ratings, also known as the interquartile range (IQR). The mean rating is represented by the diamond but should be interpreted with caution given the Milestones are ordinal, not interval data.

“Min” represents the lowest level and “Max” the highest level (the “whiskers”), excluding outliers (represented by the open circles). As would be expected, there is a general upward trajectory in this subcompetency from Year 1 (median Level 2) to Year 4 (median Level 4).

Most Milestone sets include five levels of development with transition zones between each level (designated as half increments, such as Level 2.5). In this example, the box plot for Resident Year 1 (highlighted by the red box) shows that the median is Level 2, and the IQR extends from Level 1.5 (25th percentile rank) to Level 2.5 (75th percentile rank).

With regards to Milestone levels within an individual residency year (i.e., post-graduate year or PGY), the levels can be sorted from least to greatest, and then graphed as shown in this box plot. In the example above, the highest 50 percent of the Resident Year 1 group were at or above Milestone Level 2; they are represented by everything above the median line. Fifty percent of the Year 1 residents fall between Level 1.5 and Level 2.5 (IQR). Those in the top 25 percent of Milestone judgments in the Year 1 group are shown by the top “whisker” (here labeled as “Max”) and the outlier open circles.

The outliers represent those who were judged to be substantially higher (in this case we see two outlier circles) or were judged to be much lower than normal (in this example there are no low outliers). The number of people represented by the circles will vary by the sample size of that specialty.

Box plots provide information on more than just the four split groups. They also show which way the Milestone data can “sway.” For example, if more residents/fellows are judged much higher than just a few residents/fellows being judged much lower, the median is going to be higher, or the top whisker could be longer than the bottom one. Box plots provide a better overview of the data’s distribution nationally than simple means and standard deviations.

The box plots must be interpreted in the context of the Milestones descriptions for each subcompetency within each discipline. Provided below are links to each specialty’s Milestones Sets to help guide review of the data.

Specialty:

[Allergy and Immunology](#)

[Anesthesiology](#)

[Colon and Rectal Surgery](#)

[Dermatology](#)

[Emergency Medicine](#)

[Family Medicine](#)

[Internal Medicine](#)

[Medical Genetics and Genomics](#)

[Neurological Surgery](#)

[Neurology](#)

[Nuclear Medicine](#)

[Obstetrics and Gynecology](#)

[Ophthalmology](#)

[Orthopaedic Surgery](#)

[Osteopathic Neuromusculoskeletal Medicine](#)

[Otolaryngology - Head and Neck Surgery](#)

[Pathology](#)

[Pediatrics](#)

[Physical Medicine and Rehabilitation](#)

[Plastic Surgery](#)

[Preventive Medicine](#)

(Effective July 2022 Preventive Medicine became three distinct specialties: Aerospace Medicine; Occupational and Environmental Medicine; and Public Health and General Preventive Medicine)

[Psychiatry](#)

[Radiation Oncology](#)

[Radiology](#)

[Surgery](#)

[Thoracic Surgery](#)

[Transitional Year](#)

[Urology](#)

Specialty Box Plot Report - Milestone Evaluation by Resident Year: Year-End 2021-2022

TABLE 5: SPECIALTY: Allergy and Immunology

Resident Year	1	2	Total Residents
# of Residents	158	165	323

1. Patient Care - Patient Care 1: Medical Interview and Physical Examination of Adult Allergy and Immunology Patients

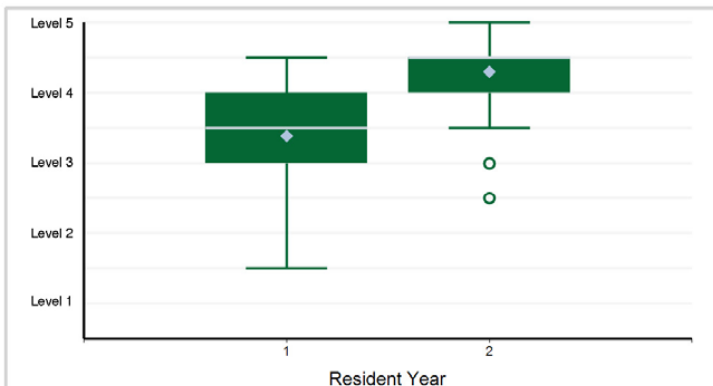

Note: 2 of 323 residents have a status of "Not Yet Assessable" and are not included in the analysis.

2. Patient Care - Patient Care 2: Medical Interview and Physical Examination of Pediatric Allergy and Immunology Patients

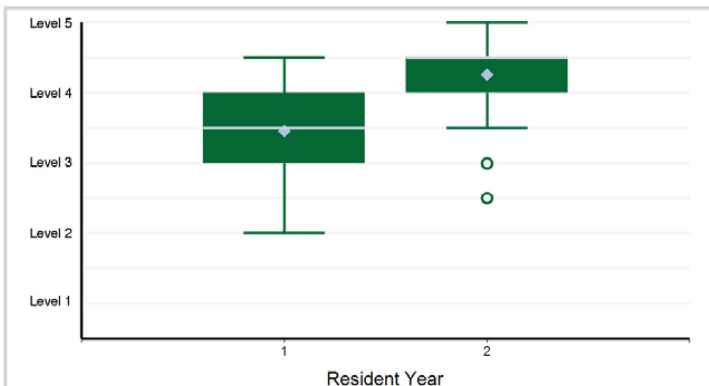

Note: 1 of 323 residents have a status of "Not Yet Assessable" and are not included in the analysis.

3. Patient Care - Patient Care 3: Diagnostic Tests and Procedures for Allergy and Immunology Patients

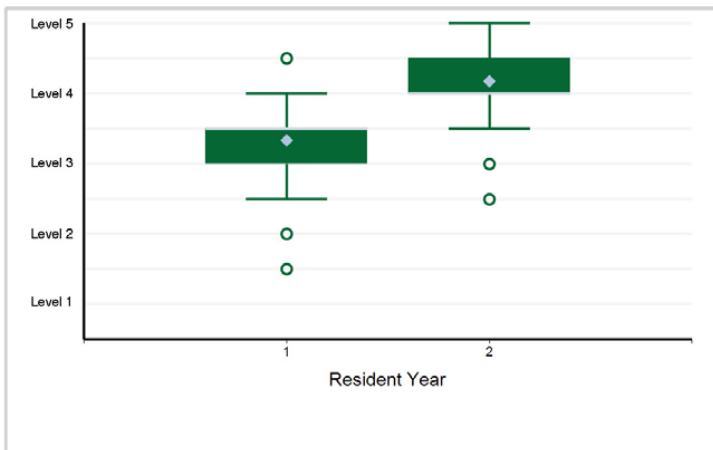

4. Patient Care - Patient Care 4: Management Plan for Allergy and Immunology Patients

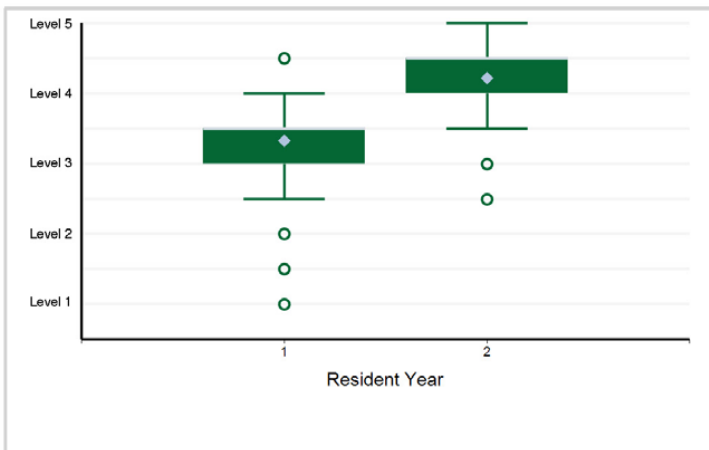

5. Medical Knowledge - Medical Knowledge 1: Basic Science of Allergy and Immunology

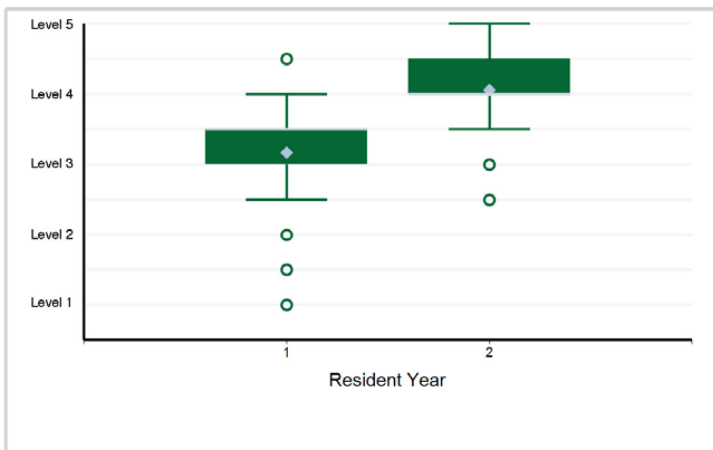

6. Medical Knowledge - Medical Knowledge 2: Clinical Science of Allergy and Immunology

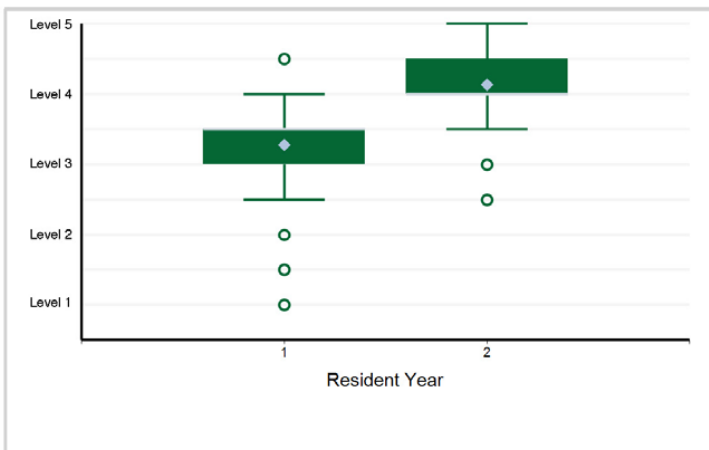

Specialty Box Plot Report - Milestone Evaluation by Resident Year: Year-End 2021-2022

SPECIALTY: Allergy and Immunology

7. Medical Knowledge - Medical Knowledge 3: Research and Scholarly Activity

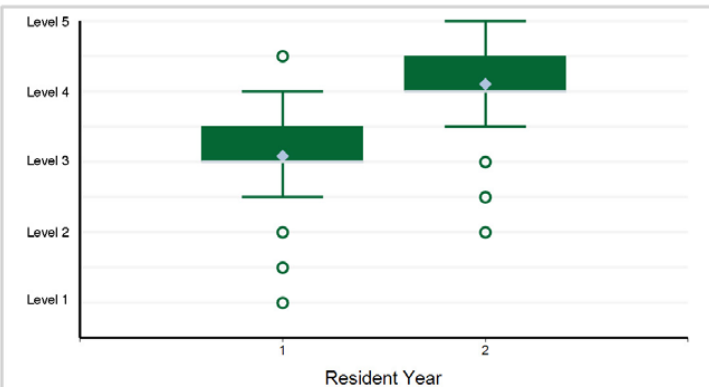

Note: 5 of 323 residents have a status of "Not Yet Assessable" and are not included in the analysis.

8. Systems-Based Practice - Systems-Based Practice 1: Patient Safety and Quality Improvement

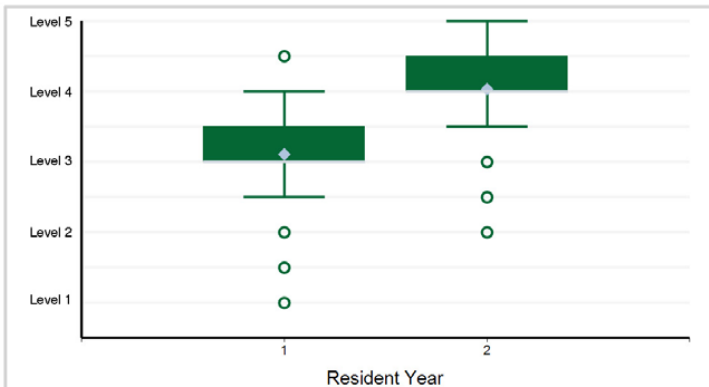

9. Systems-Based Practice - Systems-Based Practice 2: System Navigation for Patient-Centered Care

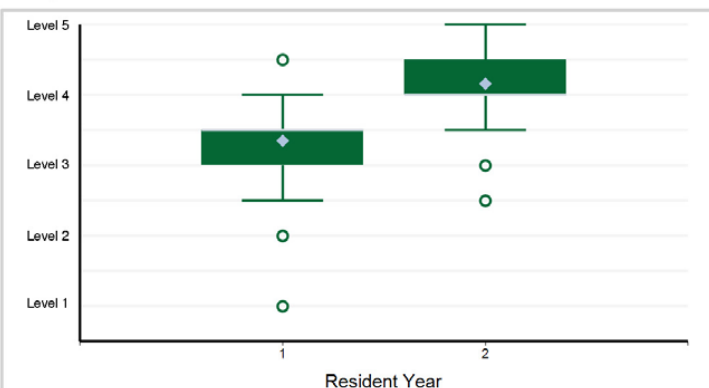

10. Systems-Based Practice - Systems-Based Practice 3: Physician Role in Health Care Systems

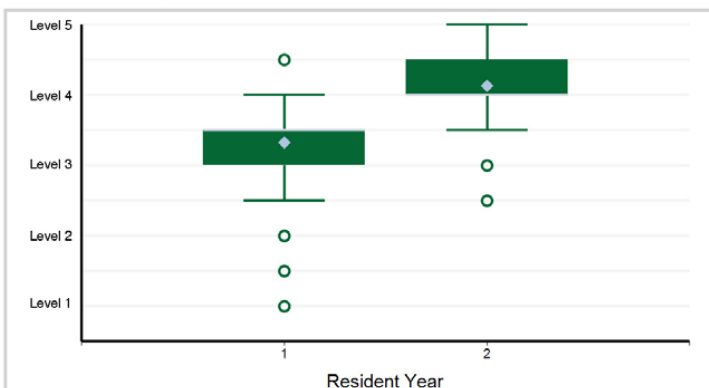

11. Systems-Based Practice - Systems-Based Practice 4: Community and Population Health

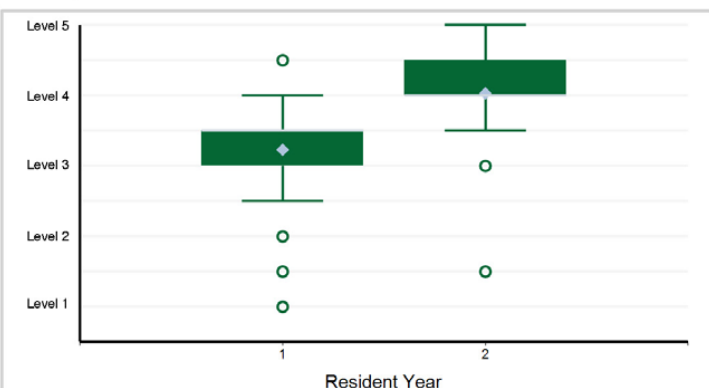

12. Practice-Based Learning and Improvement - Practice-Based Learning and Improvement 1: Evidence-Based and Informed Practice

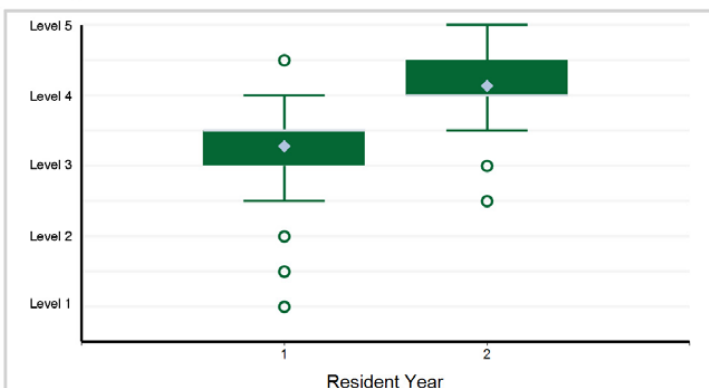

Specialty Box Plot Report - Milestone Evaluation by Resident Year: Year-End 2021-2022

SPECIALTY: Allergy and Immunology

13. Practice-Based Learning and Improvement - Practice-Based Learning and Improvement 2: Reflective Practice and Commitment ...

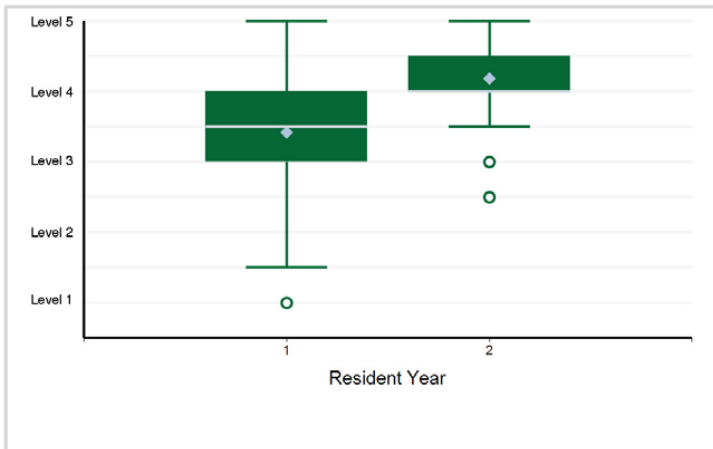

14. Professionalism - Professionalism 1: Professional Behavior and Ethical Principles

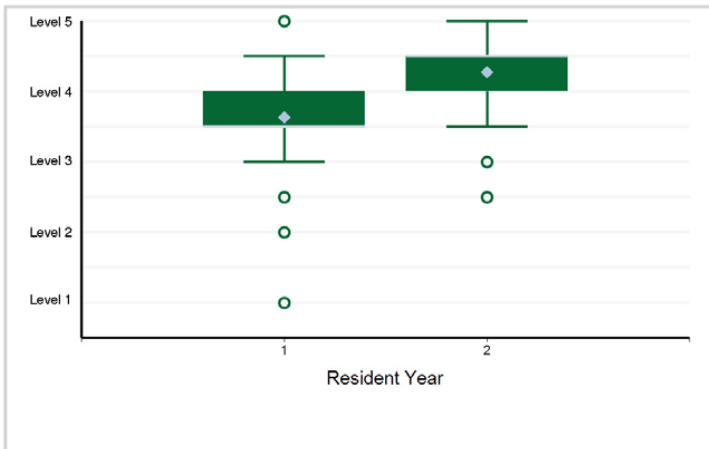

15. Professionalism - Professionalism 2: Accountability/Conscientiousness

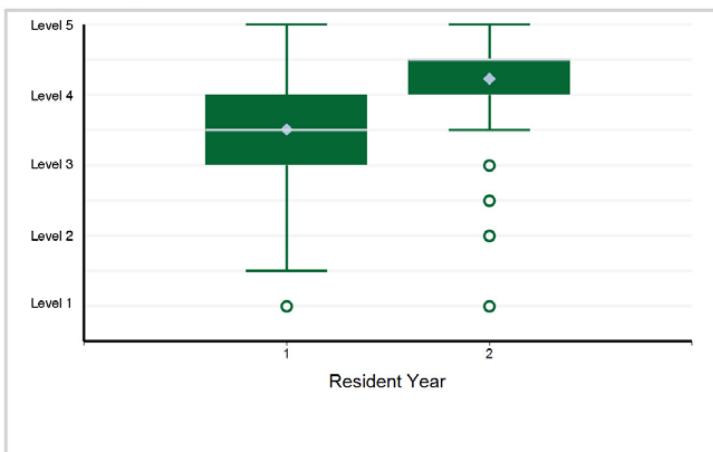

16. Professionalism - Professionalism 3: Self-Awareness and Help-Seeking

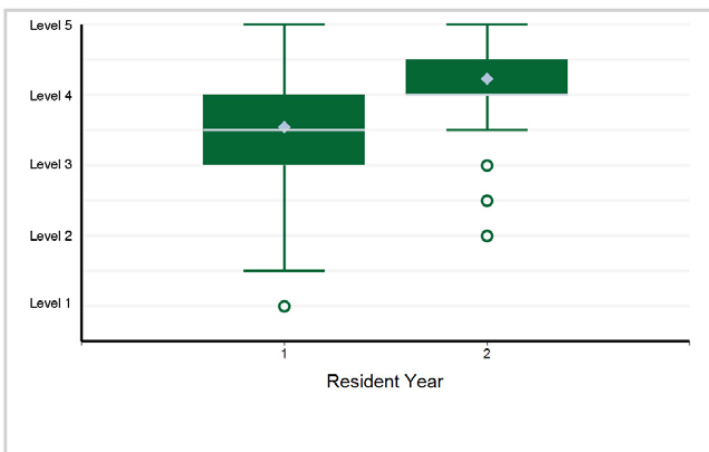

17. Interpersonal and Communication Skills - Interpersonal and Communication Skills 1: Patient and Family-Centered Communication

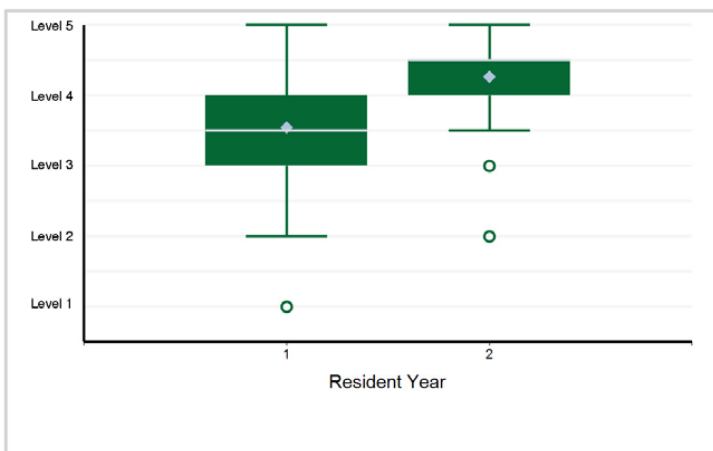

18. Interpersonal and Communication Skills - Interpersonal and Communication Skills 2: Interprofessional and Team Communication

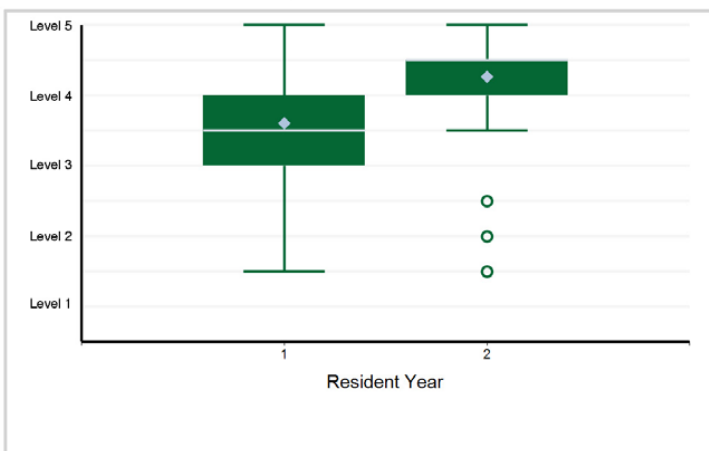

Specialty Box Plot Report - Milestone Evaluation by Resident Year: Year-End 2021-2022

SPECIALTY: **Allergy and Immunology**

19. Interpersonal and Communication Skills - Interpersonal and Communication Skills 3: Communication within Health Care Systems

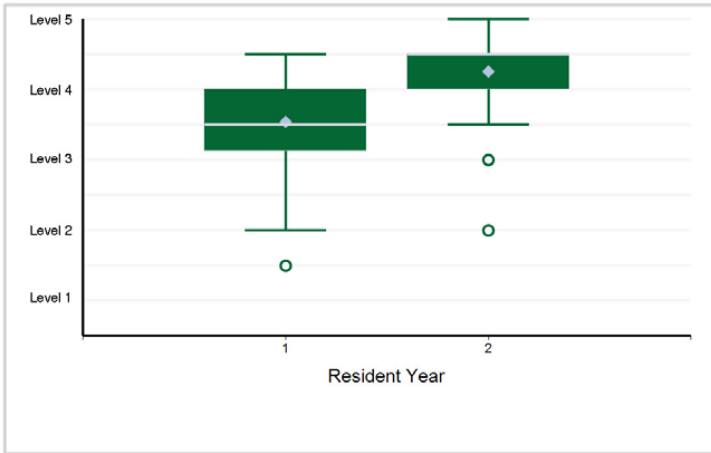

Specialty Box Plot Report - Milestone Evaluation by Resident Year: Year-End 2021-2022

TABLE 6: SPECIALTY: **Anesthesiology**

Resident Year	1	2	3	4	Total Residents
# of Residents	1,461	1,938	1,889	1,815	7,103

1. Patient Care - Patient Care 1: Pre-Anesthetic Evaluation

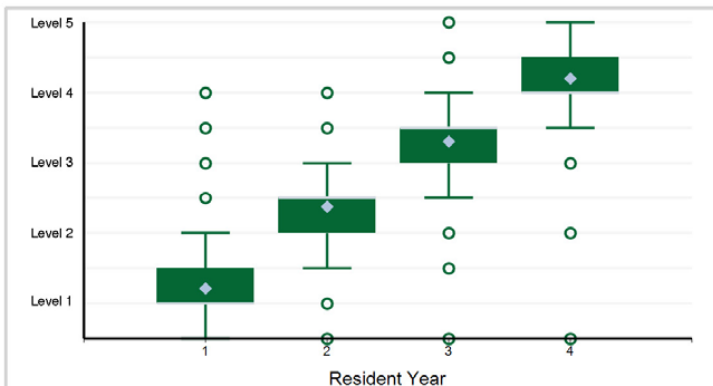

Note: 109 of 7,103 residents have a status of "Not Yet Assessable" and are not included in the analysis.

2. Patient Care - Patient Care 2: Peri-Operative Care and Management

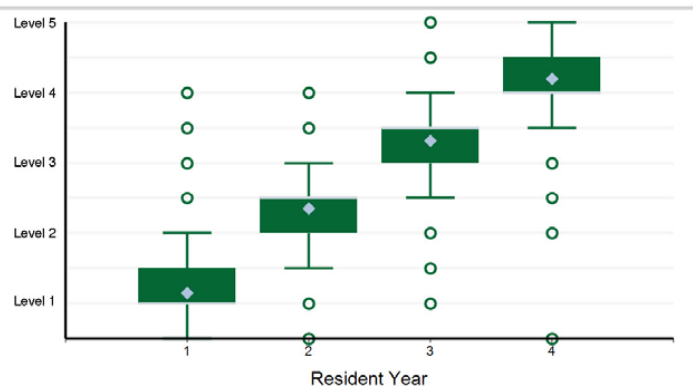

Note: 135 of 7,103 residents have a status of "Not Yet Assessable" and are not included in the analysis.

3. Patient Care - Patient Care 3: Application and Interpretation of Monitors

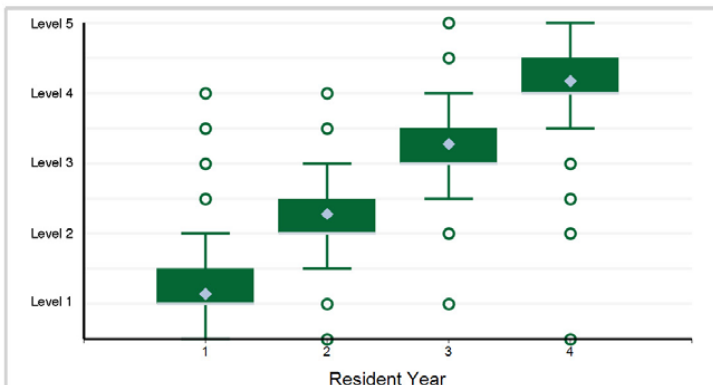

Note: 127 of 7,103 residents have a status of "Not Yet Assessable" and are not included in the analysis.

4. Patient Care - Patient Care 4: Intra-Operative Care

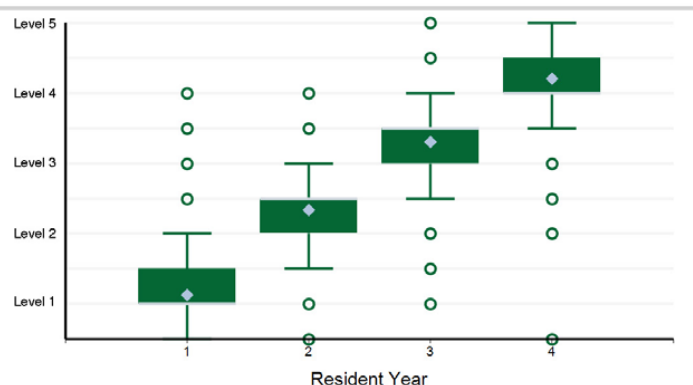

Note: 146 of 7,103 residents have a status of "Not Yet Assessable" and are not included in the analysis.

5. Patient Care - Patient Care 5: Airway Management

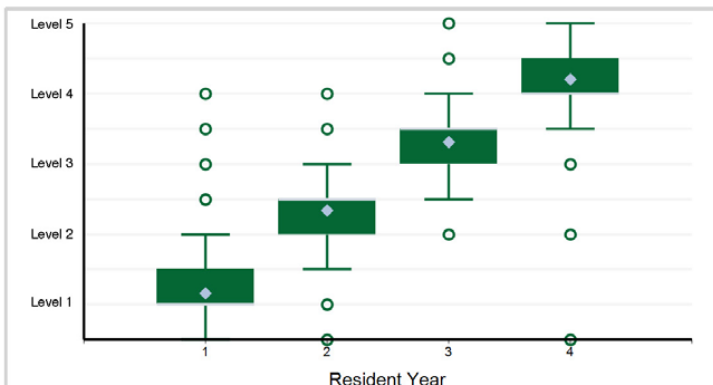

Note: 129 of 7,103 residents have a status of "Not Yet Assessable" and are not included in the analysis.

6. Patient Care - Patient Care 6: Point-of-Care Ultrasound

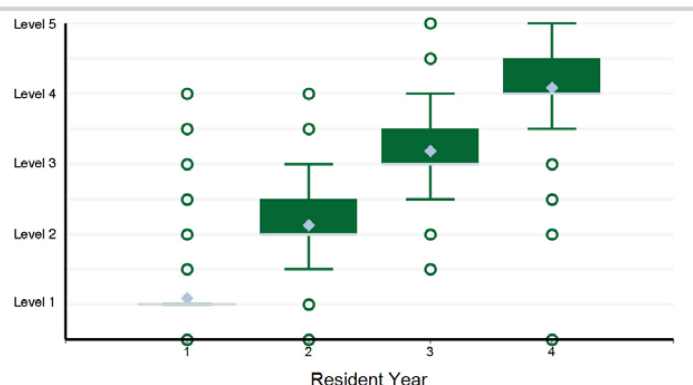

Note: 213 of 7,103 residents have a status of "Not Yet Assessable" and are not included in the analysis.

Specialty Box Plot Report - Milestone Evaluation by Resident Year: Year-End 2021-2022

SPECIALTY: Anesthesiology

7. Patient Care - Patient Care 7: Situational Awareness and Crisis Management

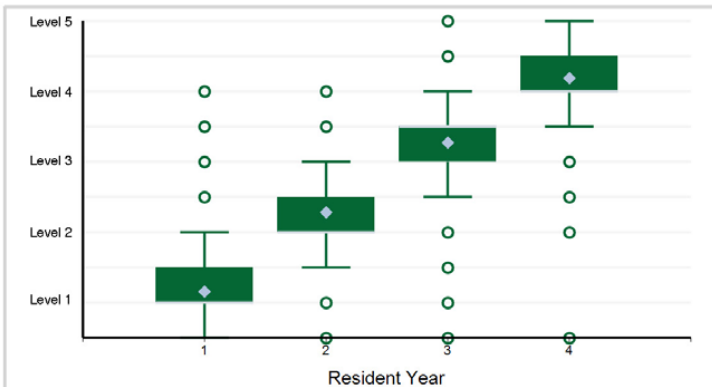

Note: 99 of 7,103 residents have a status of "Not Yet Assessable" and are not included in the analysis.

8. Patient Care - Patient Care 8: Post-Operative Care

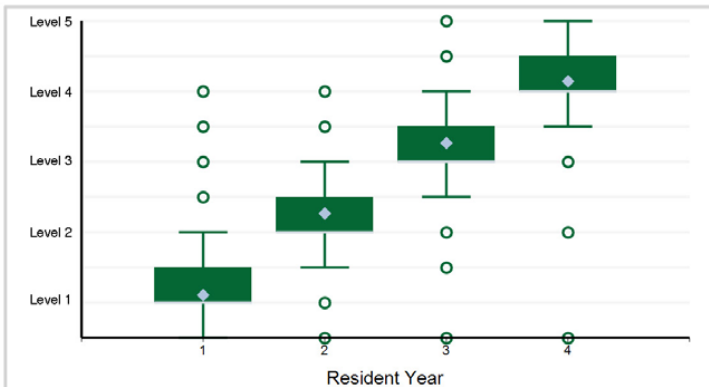

Note: 142 of 7,103 residents have a status of "Not Yet Assessable" and are not included in the analysis.

9. Patient Care - Patient Care 9: Critical Care

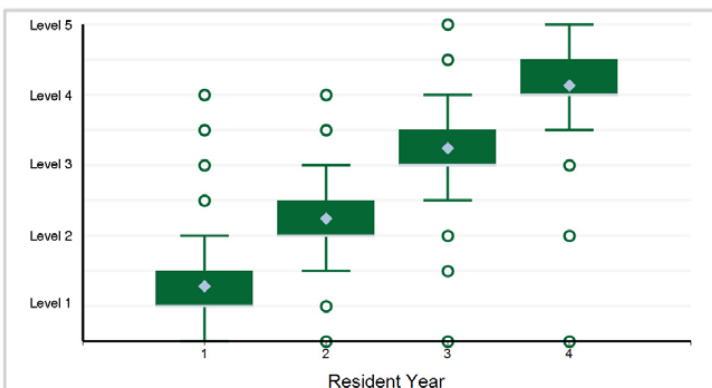

Note: 91 of 7,103 residents have a status of "Not Yet Assessable" and are not included in the analysis.

10. Patient Care - Patient Care 10: Regional (Peripheral and Neuraxial) Anesthesia

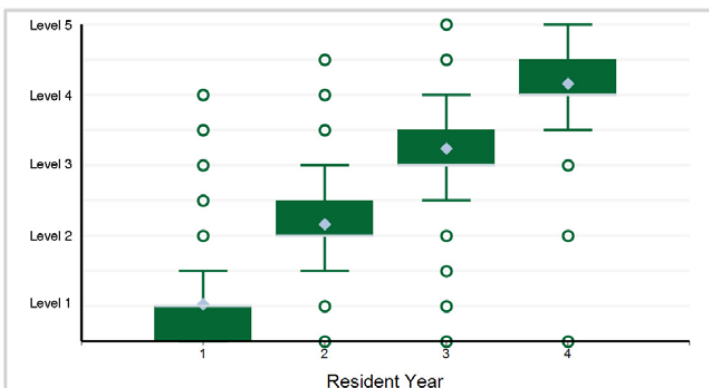

Note: 243 of 7,103 residents have a status of "Not Yet Assessable" and are not included in the analysis.

11. Medical Knowledge - Medical Knowledge 1: Foundational Knowledge

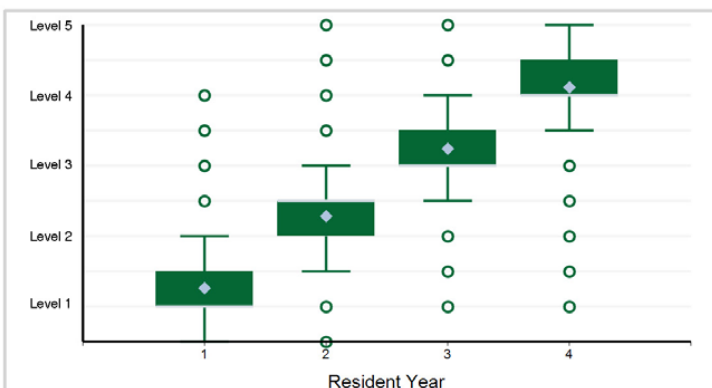

Note: 25 of 7,103 residents have a status of "Not Yet Assessable" and are not included in the analysis.

12. Medical Knowledge - Medical Knowledge 2: Clinical Reasoning

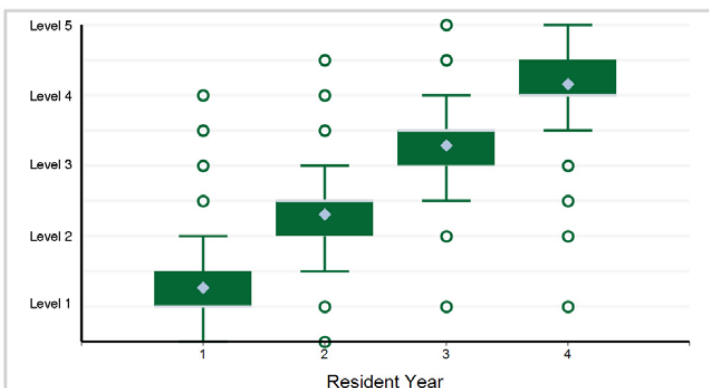

Note: 46 of 7,103 residents have a status of "Not Yet Assessable" and are not included in the analysis.

Specialty Box Plot Report - Milestone Evaluation by Resident Year: Year-End 2021-2022

SPECIALTY: Anesthesiology

13. Systems-Based Practice - Systems-Based Practice 1: Patient Safety and Quality Improvement

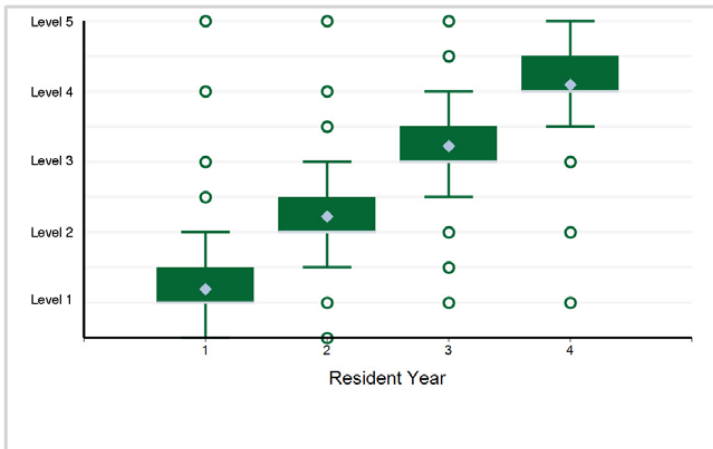

14. Systems-Based Practice - Systems-Based Practice 2: System Navigation for Patient-Centered Care

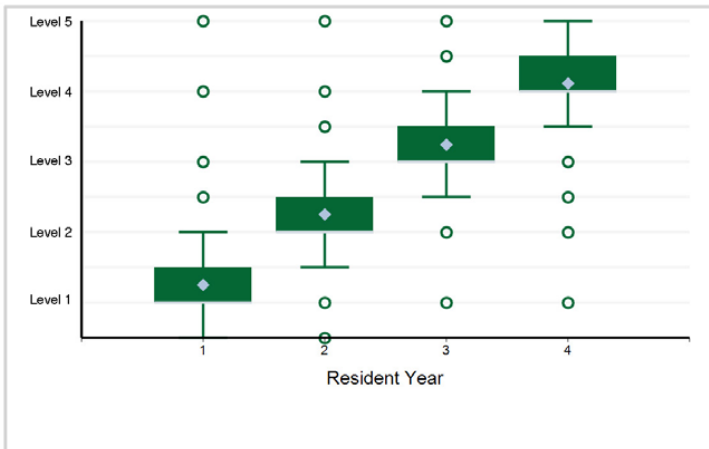

15. Systems-Based Practice - Systems-Based Practice 3: Physician Role in Health Care Systems

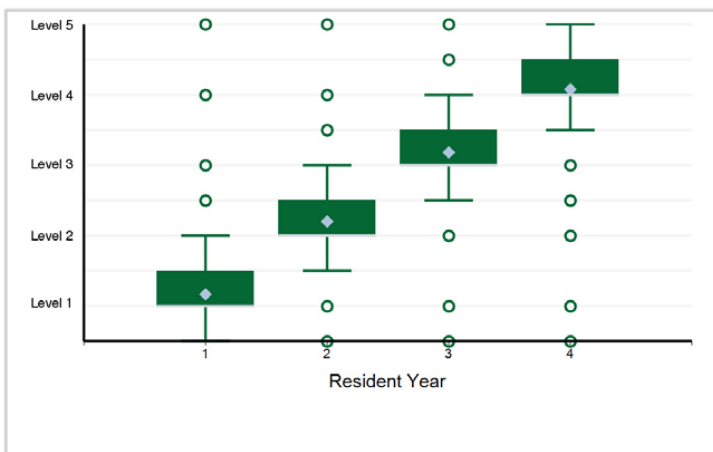

16. Practice-Based Learning and Improvement - Practice-Based Learning and Improvement 1: Evidence-Based and Informed Practice

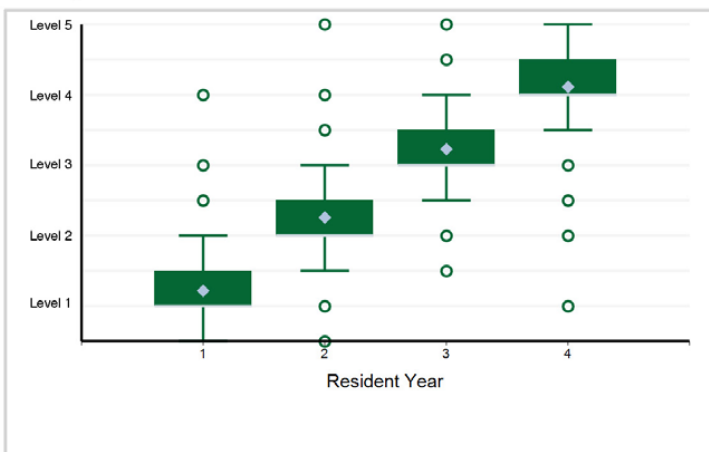

17. Practice-Based Learning and Improvement - Practice-Based Learning and Improvement 2: Reflective Practice and Commitment ...

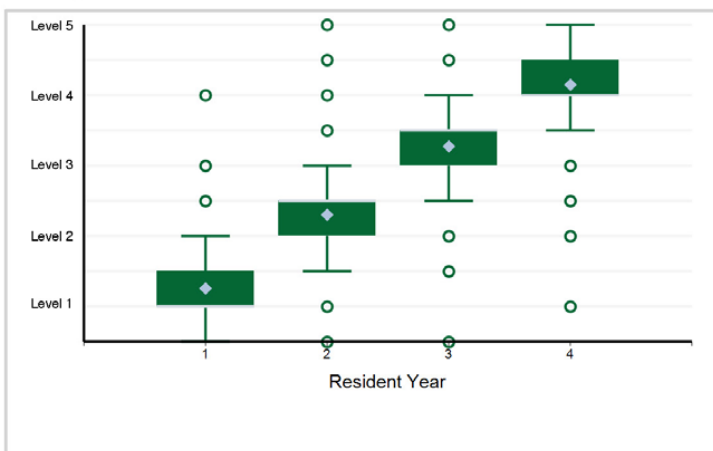

18. Professionalism - Professionalism 1: Professional Behavior and Ethical Principles

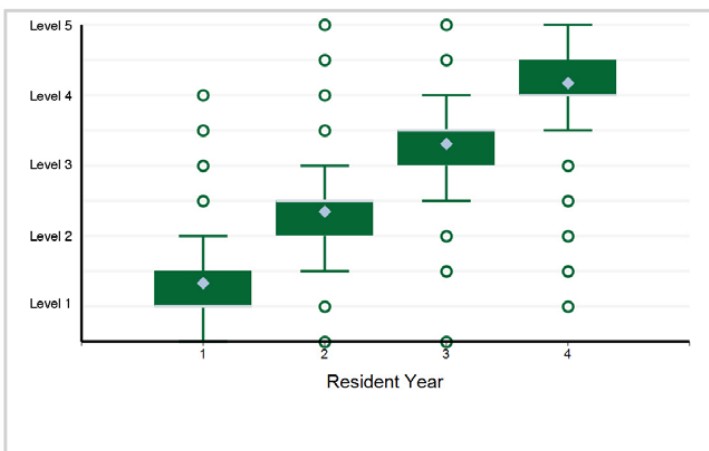

Specialty Box Plot Report - Milestone Evaluation by Resident Year: Year-End 2021-2022

SPECIALTY: Anesthesiology

19. Professionalism - Professionalism 2: Accountability/Conscientiousness

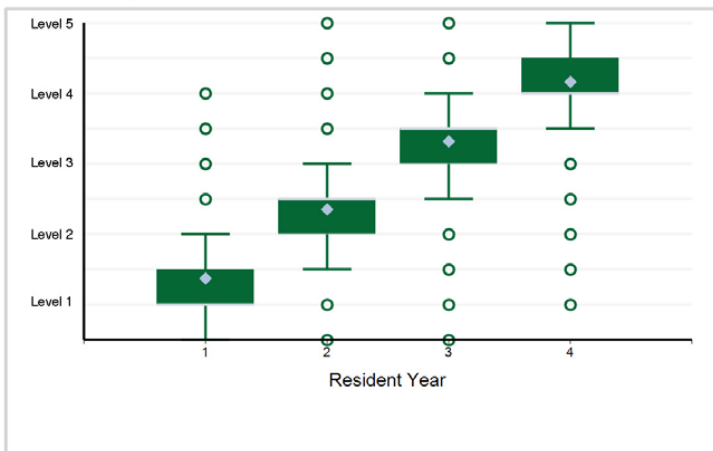

20. Professionalism - Professionalism 3: Well-Being

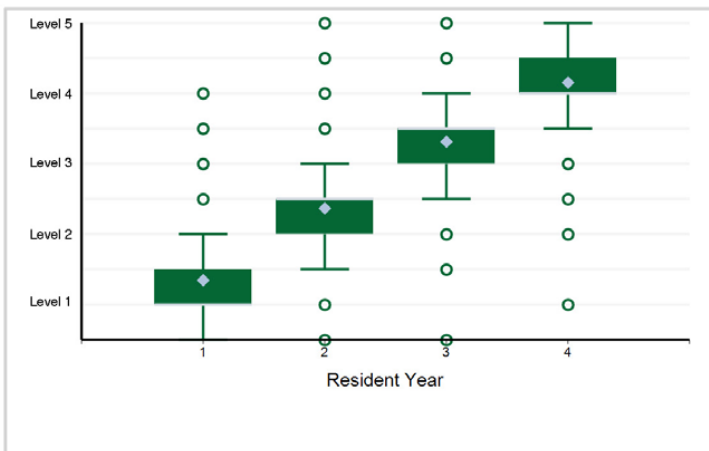

21. Interpersonal and Communication Skills - Interpersonal and Communication Skills 1: Patient- and Family-Centered Communication

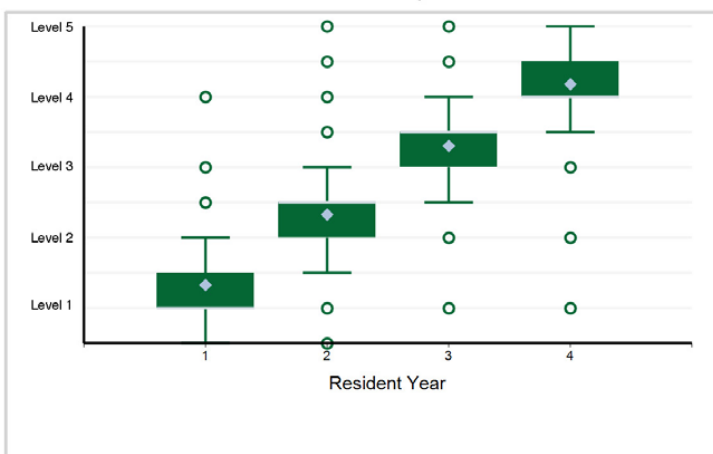

22. Interpersonal and Communication Skills - Interpersonal and Communication Skills 2: Interprofessional and Team Communication

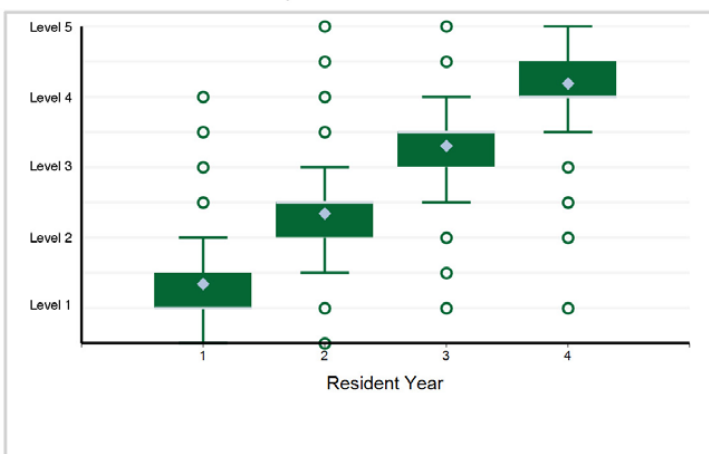

23. Interpersonal and Communication Skills - Interpersonal and Communication Skills 3: Communication within Health Care Systems

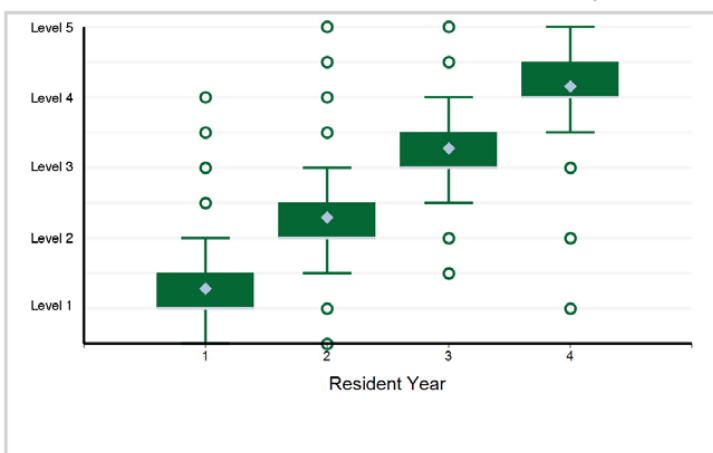

Specialty Box Plot Report - Milestone Evaluation by Resident Year: Year-End 2021-2022

TABLE 7: SUBSPECIALTY: **Adult Cardiothoracic Anesthesiology**

Resident Year	1	Total Residents
# of Residents	244	244

1. Patient Care - Patient Care — Peri-procedural Assessment and Management

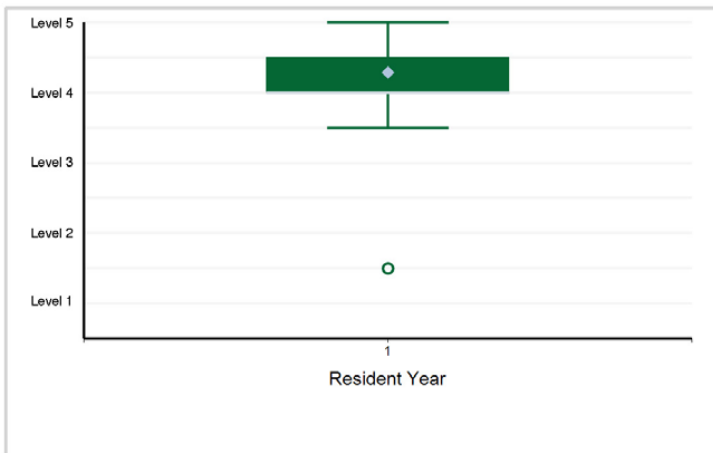

2. Patient Care - Patient Care — Technical/Procedural Skills

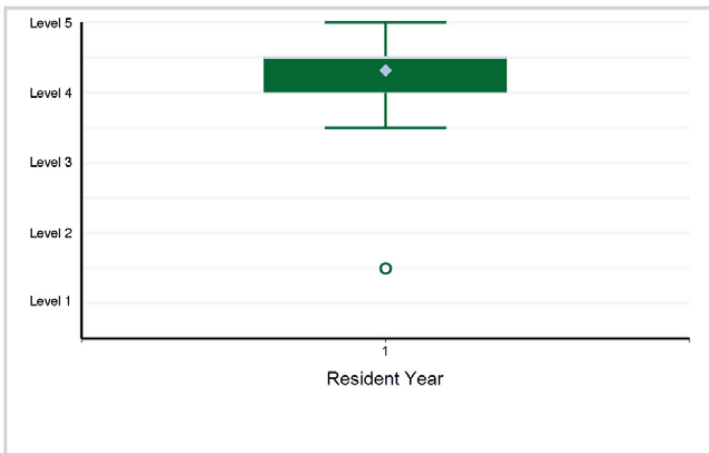

3. Medical Knowledge - Medical Knowledge — Extracorporeal Circulation and Circulatory Assist Device Principles

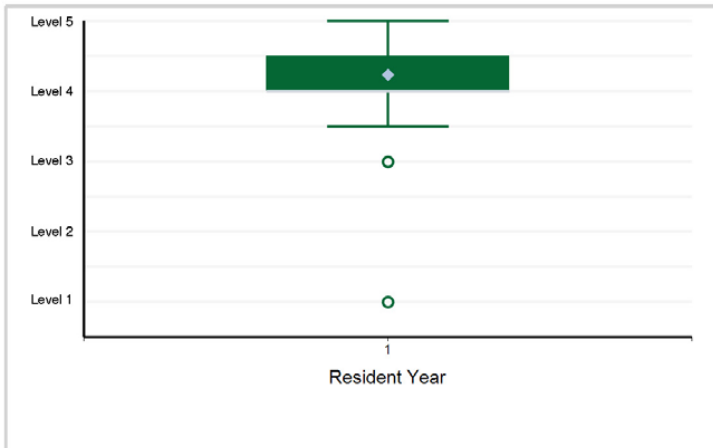

4. Medical Knowledge - Medical Knowledge — Cardiovascular/Thoracic Imaging and Monitoring



5. Medical Knowledge - Medical Knowledge — Cardiovascular/Thoracic Pathophysiology and Pharmacology

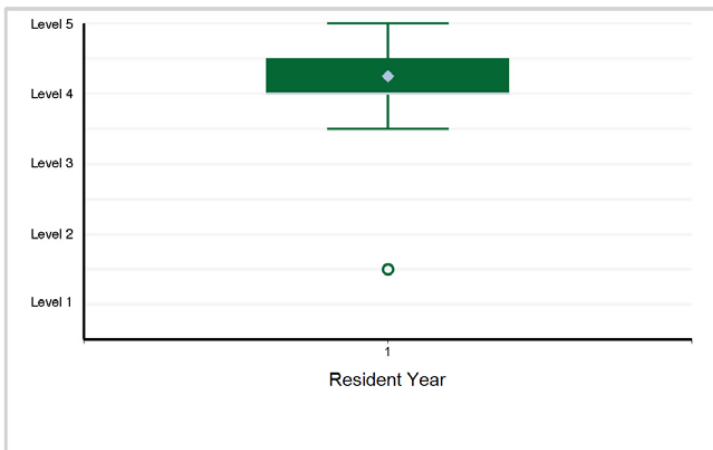

6. Medical Knowledge - Medical Knowledge — Diagnostic and Therapeutic Interventions

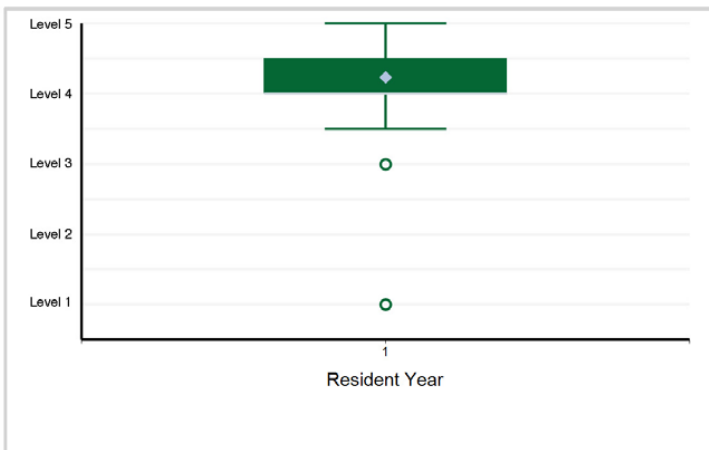

Specialty Box Plot Report - Milestone Evaluation by Resident Year: Year-End 2021-2022

SUBSPECIALTY: Adult Cardiothoracic Anesthesiology

7. Systems-Based Practice - Systems-Based Practice — Interprofessional and Transitions of Care

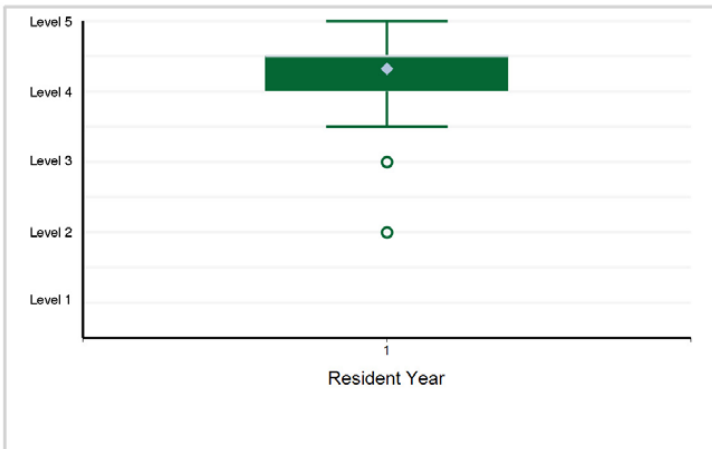

8. Systems-Based Practice - Systems-Based Practice — Incorporation of Patient Safety and Quality Improvement into Clinical ...

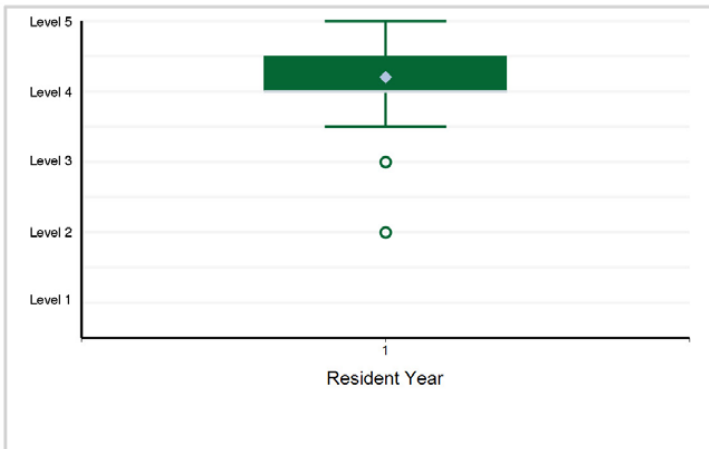

9. Systems-Based Practice - Systems-Based Practice — Understanding of Health Care Economics: Cost Awareness ...

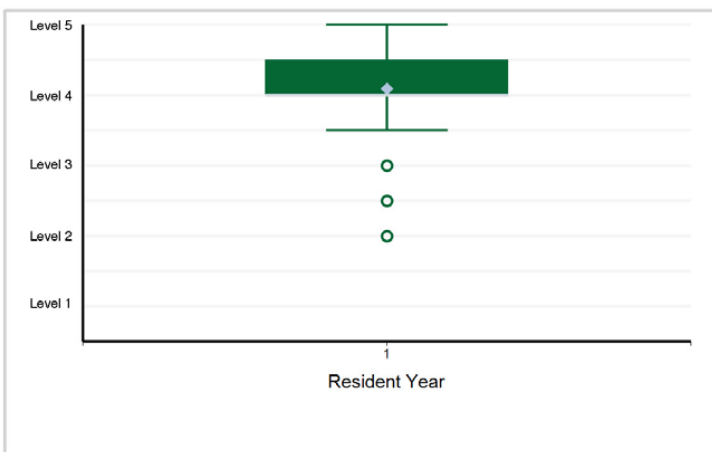

10. Practice-Based Learning and Improvement - Practice-Based Learning and Improvement — Self-directed Learning ...

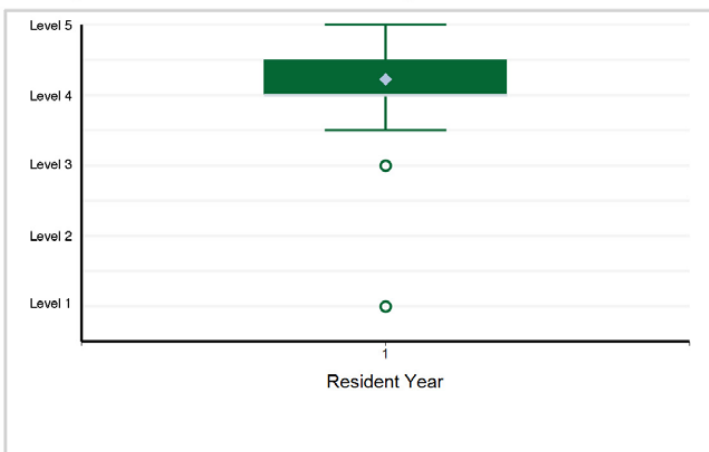

11. Practice-Based Learning and Improvement - Practice-Based Learning and Improvement — Education of Team Members and Other ...

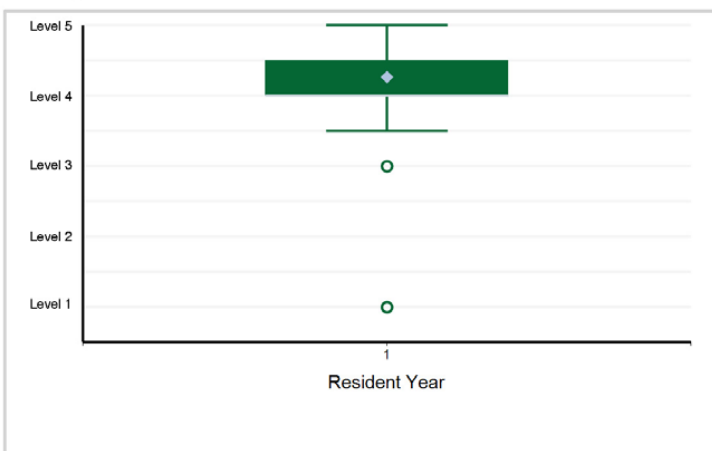

12. Professionalism - Professionalism — Commitment to Institution, Department, and Colleagues

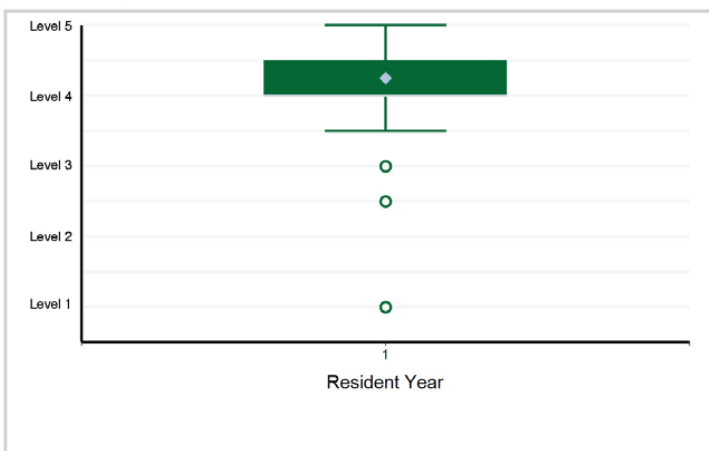

Specialty Box Plot Report - Milestone Evaluation by Resident Year: Year-End 2021-2022

SUBSPECIALTY: Adult Cardiothoracic Anesthesiology

13. Professionalism - Professionalism — Receiving and Giving Feedback

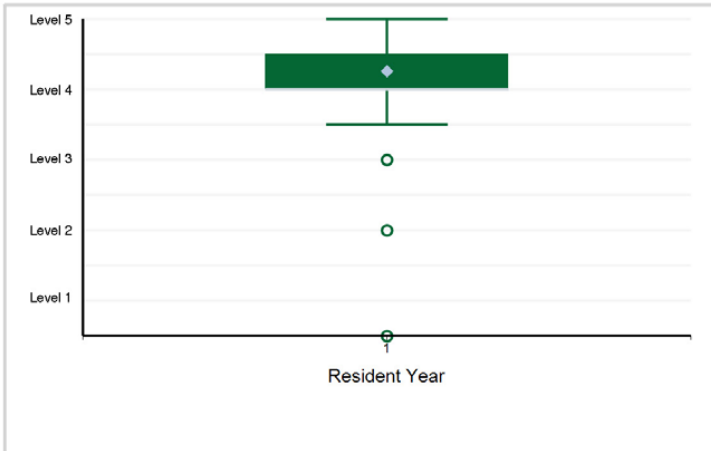

14. Professionalism - Professionalism — Responsibility to Maintain Personal, Emotional, Physical, and Mental Health

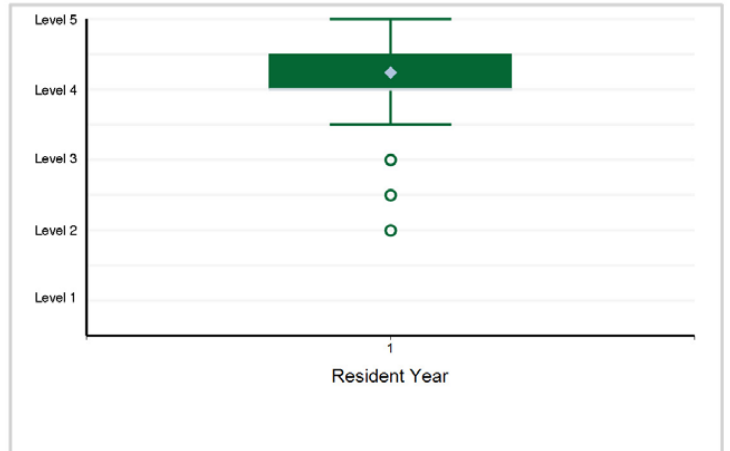

15. Interpersonal and Communication Skills - Interpersonal and Communications Skills — Communication with Patients and Families

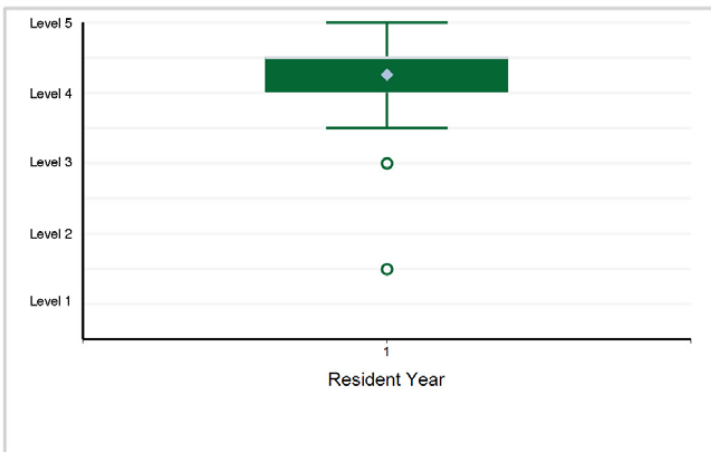

Specialty Box Plot Report - Milestone Evaluation by Resident Year: Year-End 2021-2022

TABLE 8: SUBSPECIALTY: **Critical Care Anesthesiology**

Resident Year	1	Total Residents
# of Residents	208	208

1. Patient Care - Patient Care: Patient Assessment and Development of a Care Plan

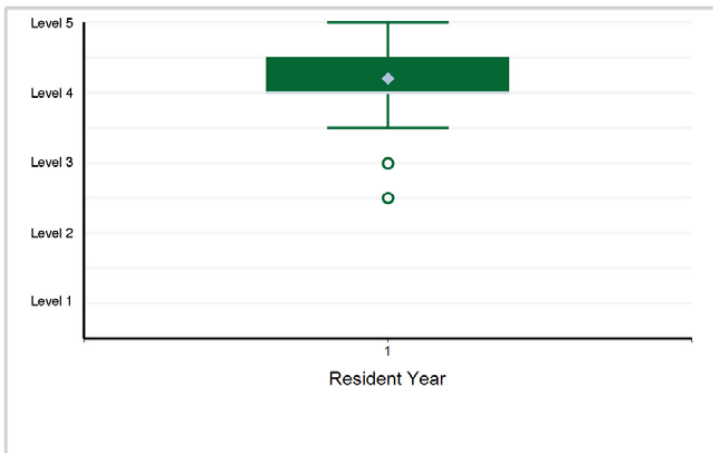

2. Patient Care - Patient Care: Crisis Management

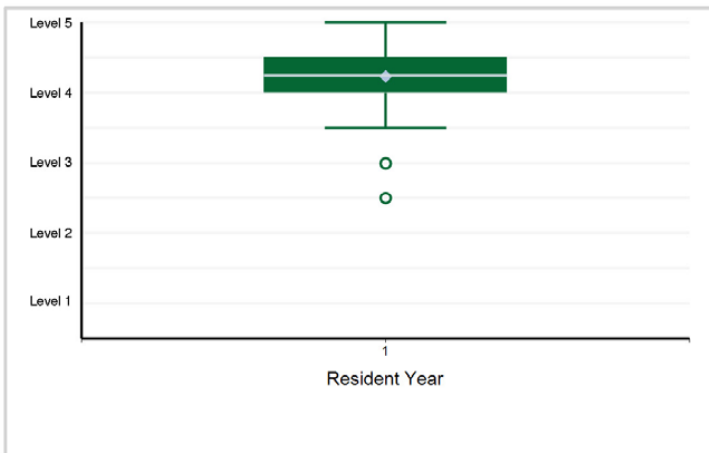

3. Patient Care - Patient Care: Procedural Skills/Technical Abilities/Interpretation

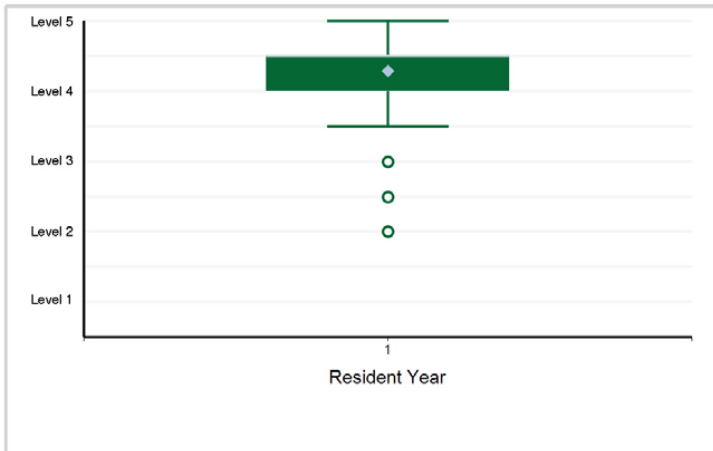

4. Patient Care - Patient Care: Management of Respiratory Failure

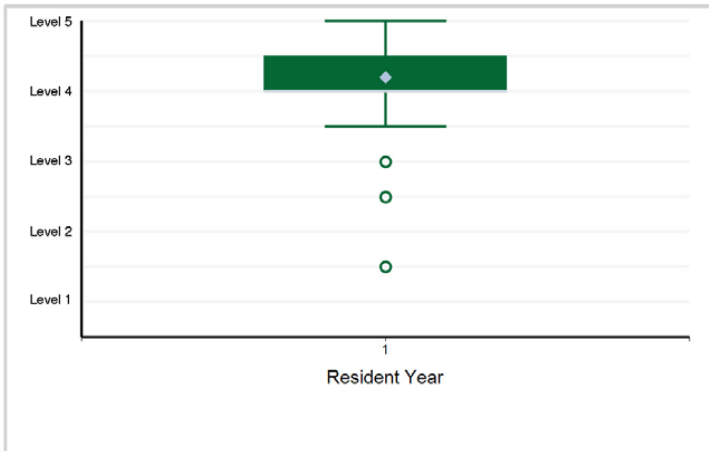

5. Patient Care - Patient Care: Palliative Medicine/End-of-Life Care

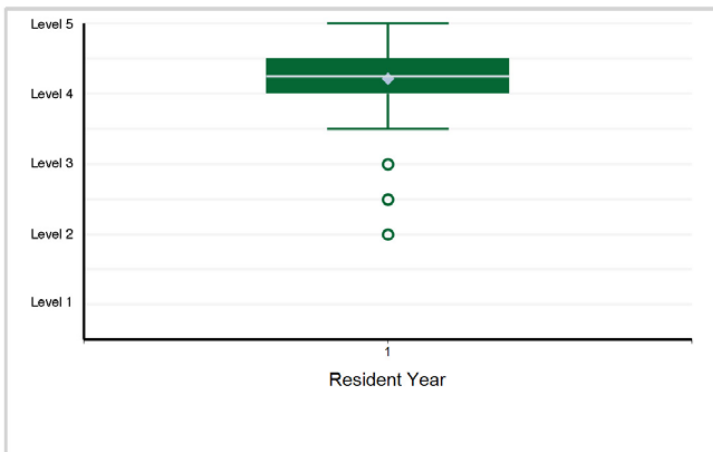

6. Medical Knowledge - Medical Knowledge: Pharmacology



Specialty Box Plot Report - Milestone Evaluation by Resident Year: Year-End 2021-2022

SUBSPECIALTY: Critical Care Anesthesiology

7. Medical Knowledge - Medical Knowledge: Medical Knowledge of Critical Care Medicine

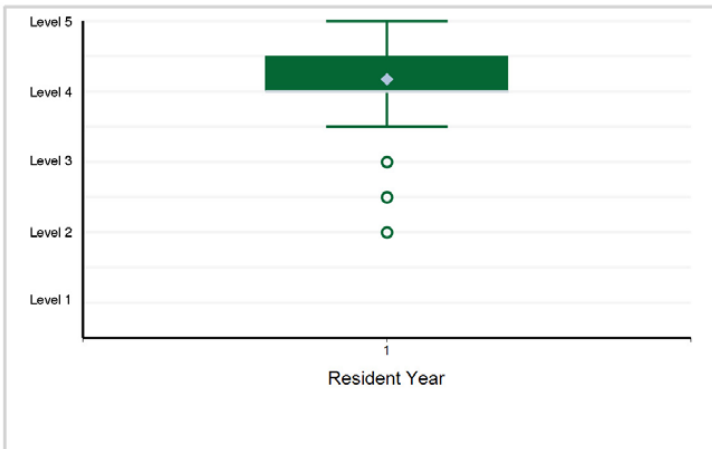

8. Systems-Based Practice - Systems-Based Practice: Interprofessional and Transitions of Care



9. Systems-Based Practice - Systems-Based Practice: Incorporation of Patient Safety and Quality Improvement into Clinical Practice

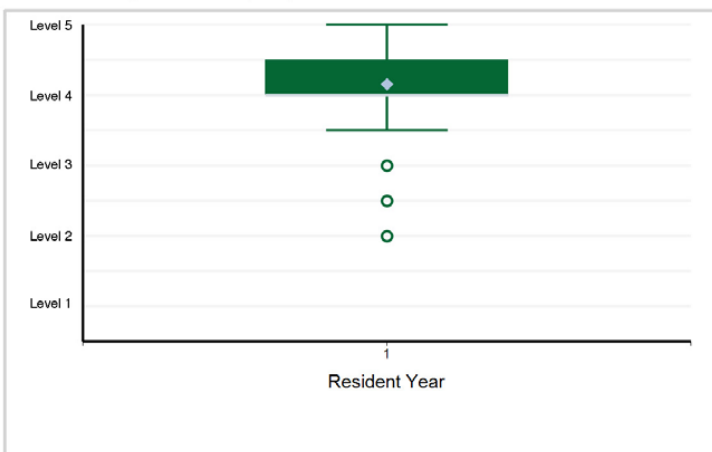

10. Systems-Based Practice - Systems-Based Practice: Understanding of Health Care Economics – Cost Awareness ...

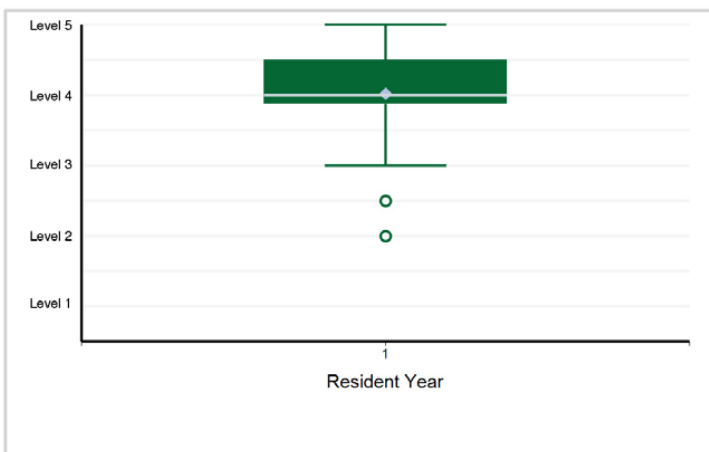

11. Practice-Based Learning and Improvement - Practice-Based Learning and Improvement: Self-directed Learning and Scholarly ...

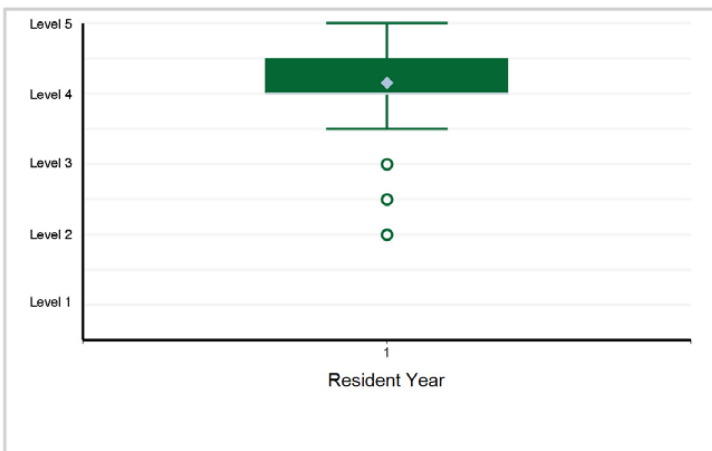

12. Practice-Based Learning and Improvement - Practice-Based Learning and Improvement: Education of Team ...

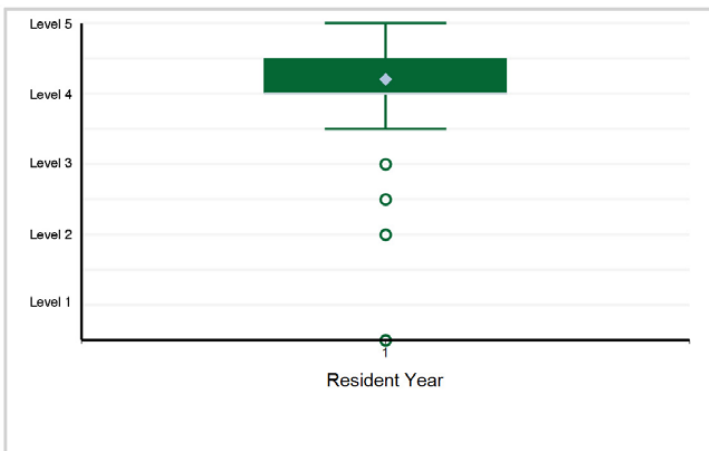

Specialty Box Plot Report - Milestone Evaluation by Resident Year: Year-End 2021-2022

SUBSPECIALTY: Critical Care Anesthesiology

13. Professionalism - Professionalism: Commitment to Institution, Department, and Colleagues

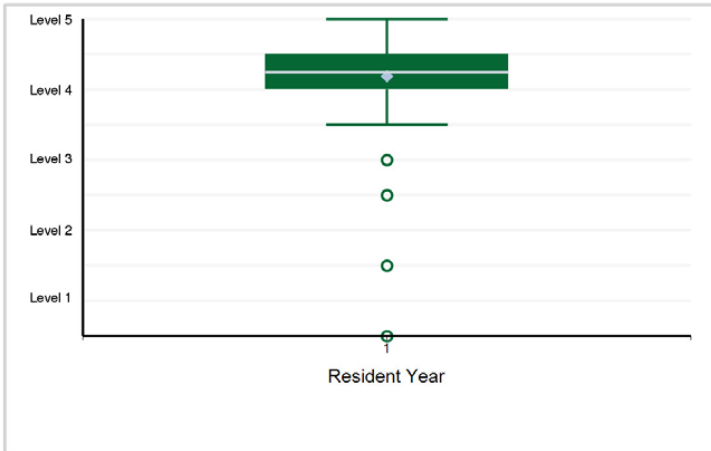

14. Professionalism - Professionalism: Receiving and Giving Feedback

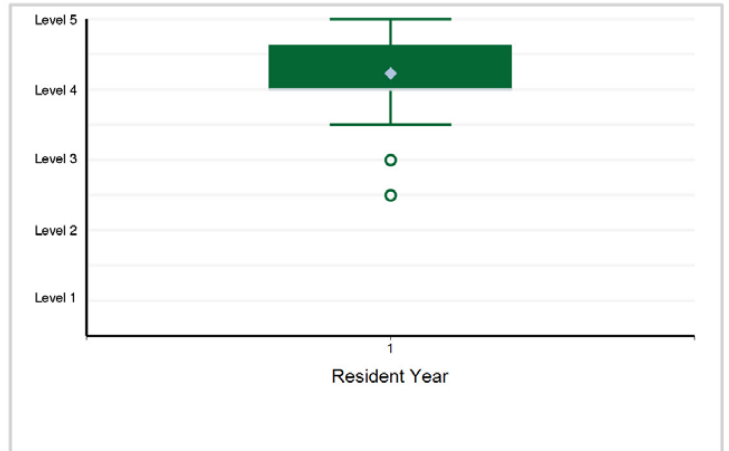

15. Professionalism - Professionalism: Responsibility to Maintain Personal Emotional, Physical, and Mental Health

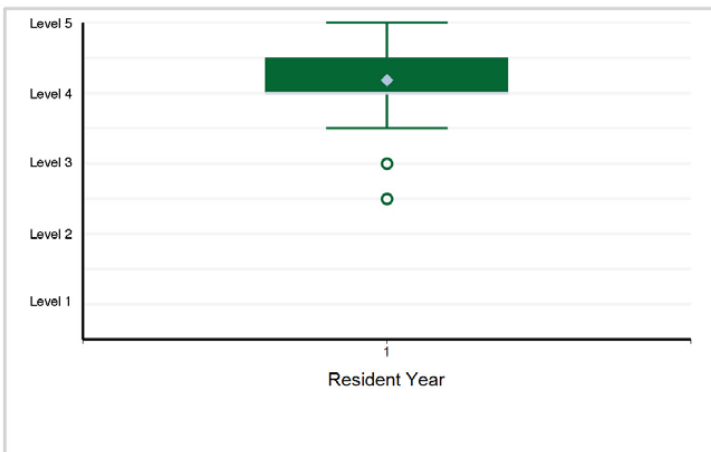

16. Interpersonal and Communication Skills - Interpersonal and Communications Skills: Communication with Patients and Families

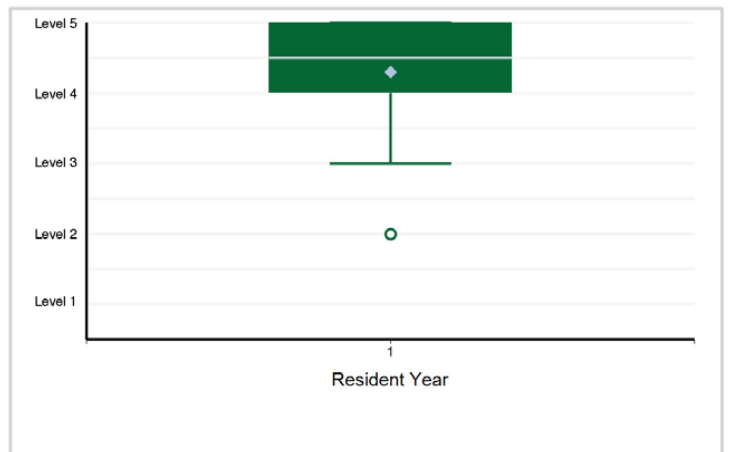

Specialty Box Plot Report - Milestone Evaluation by Resident Year: Year-End 2021-2022

TABLE 9: SUBSPECIALTY: **Obstetric Anesthesiology**

Resident Year	1	Total Residents
# of Residents	57	57

1. Patient Care - Patient Care: Technical Skills

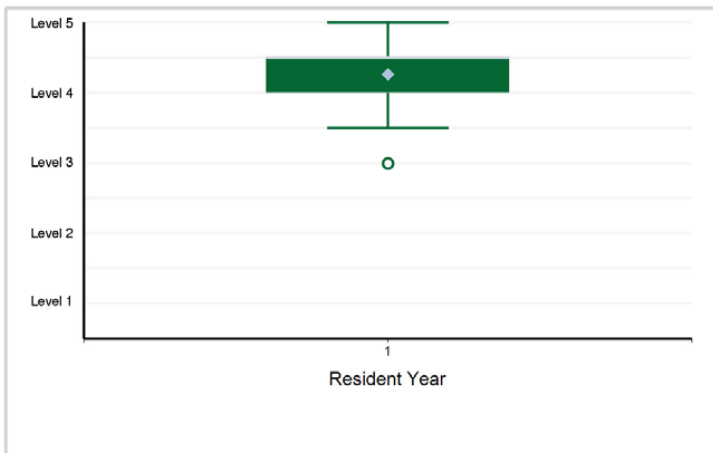

2. Patient Care - Patient Care: Triage and Coordination of Obstetric Anesthesia Care

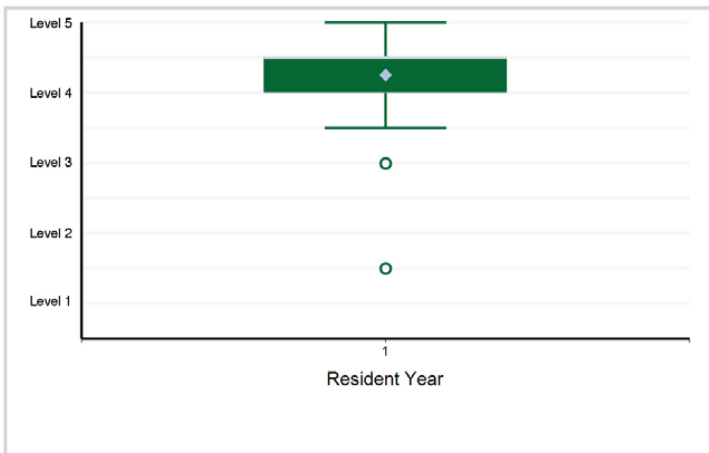

3. Patient Care - Patient Care: Crisis Management and Management of Complications

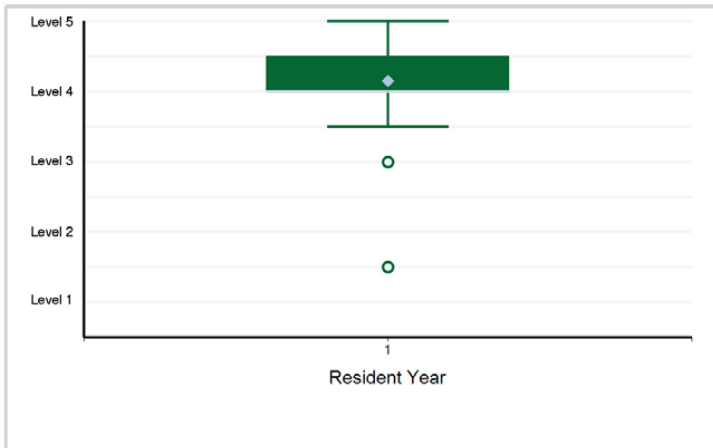

4. Patient Care - Patient Care: Preoperative Assessment and perianesthetic Care Planning

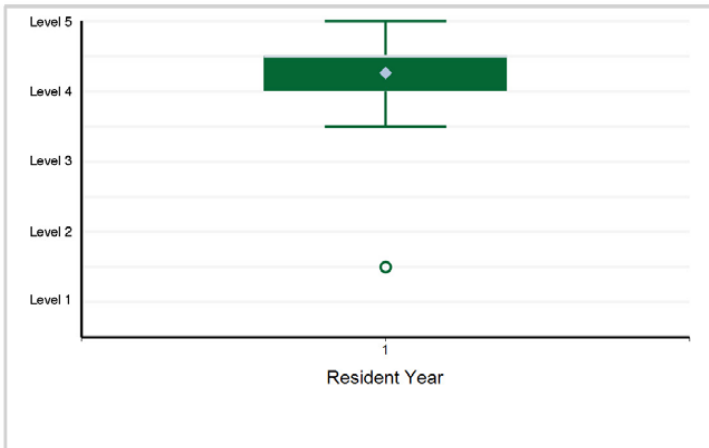

5. Medical Knowledge - Medical Knowledge: Obstetric Anesthesiology

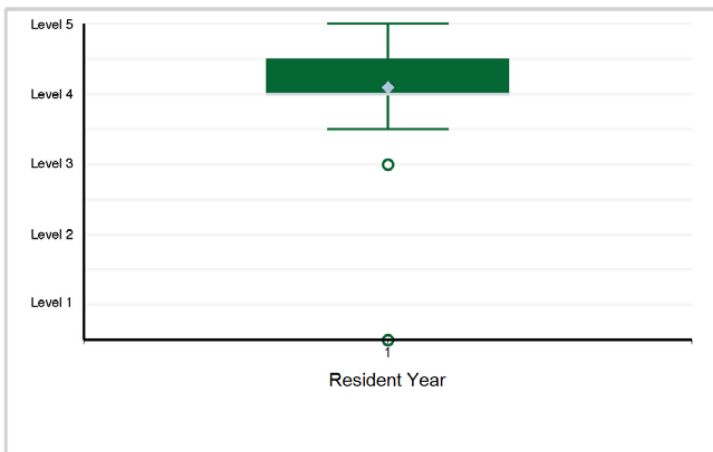

6. Medical Knowledge - Medical Knowledge: Obstetrics and Neonatology Knowledge Applied to Obstetric Anesthesiology

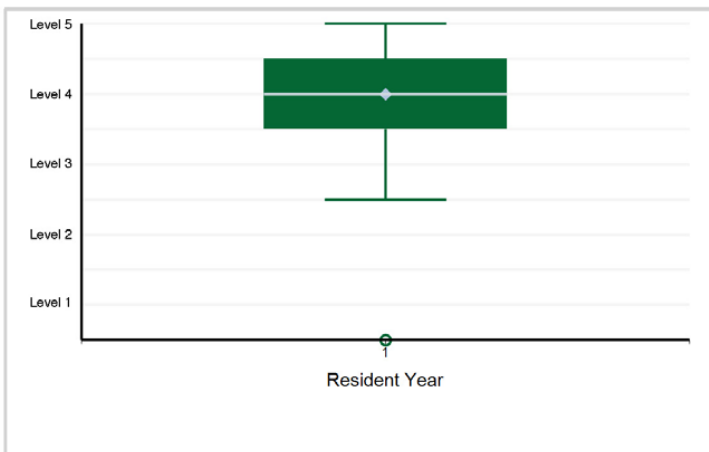

Specialty Box Plot Report - Milestone Evaluation by Resident Year: Year-End 2021-2022

SUBSPECIALTY: Obstetric Anesthesiology

7. Systems-Based Practice - Systems-Based Practice: Interprofessional and Transitions of Care

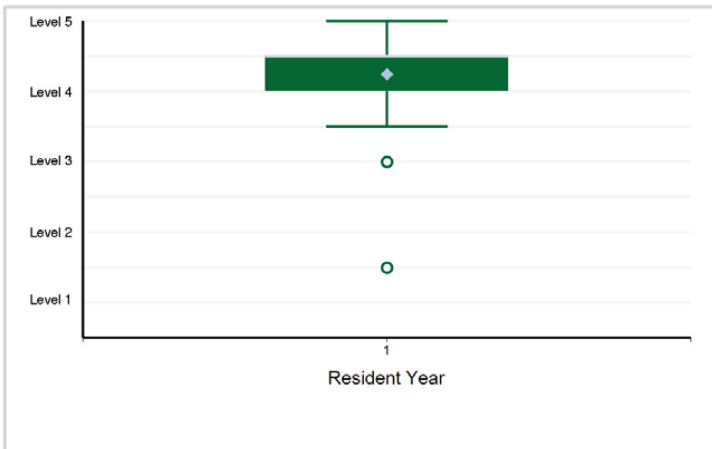

8. Systems-Based Practice - Systems-Based Practice: Incorporation of Patient Safety and Quality Improvement into Clinical Practice

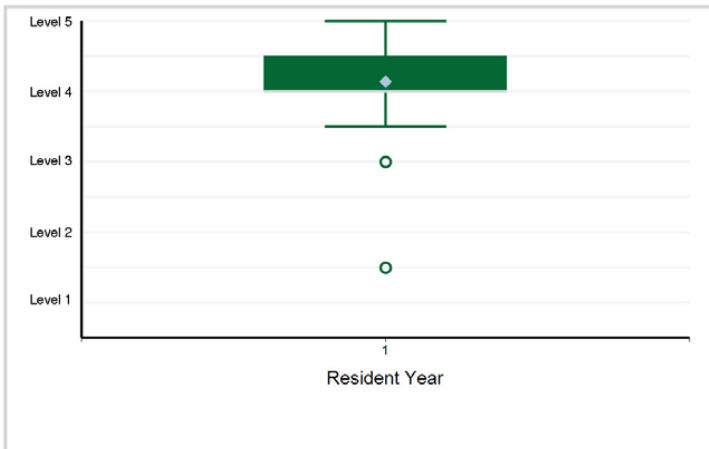

9. Systems-Based Practice - Systems-Based Practice: Understanding of Health Care Economics: Cost-awareness ...

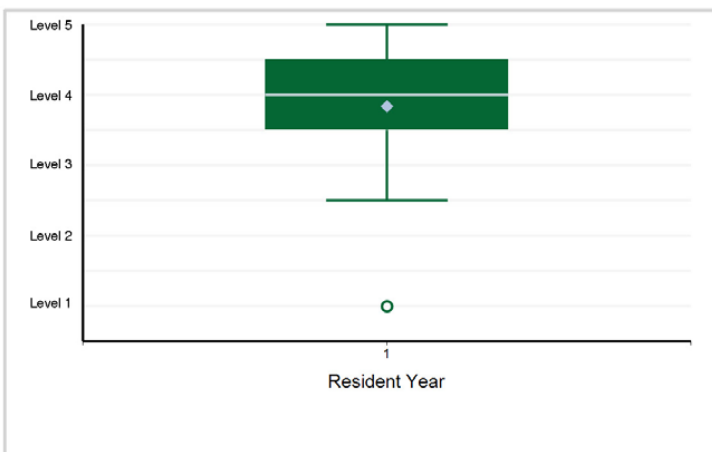

10. Practice-Based Learning and Improvement - Practice-Based Learning and Improvement: Self-directed Learning and Scholarly ...

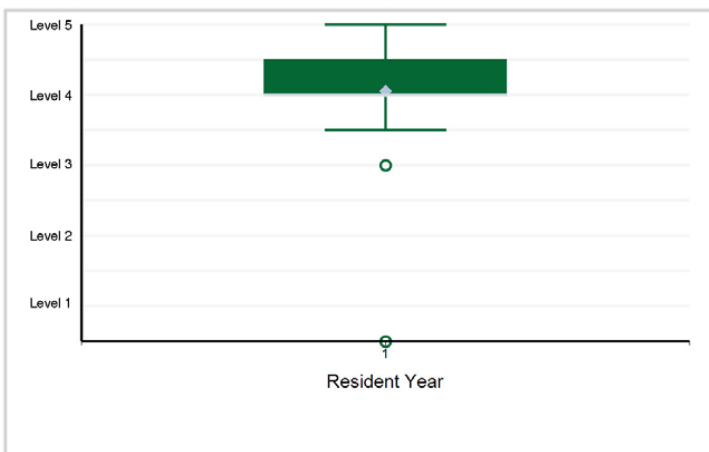

11. Practice-Based Learning and Improvement - Practice-Based Learning and Improvement: Education of Team ...

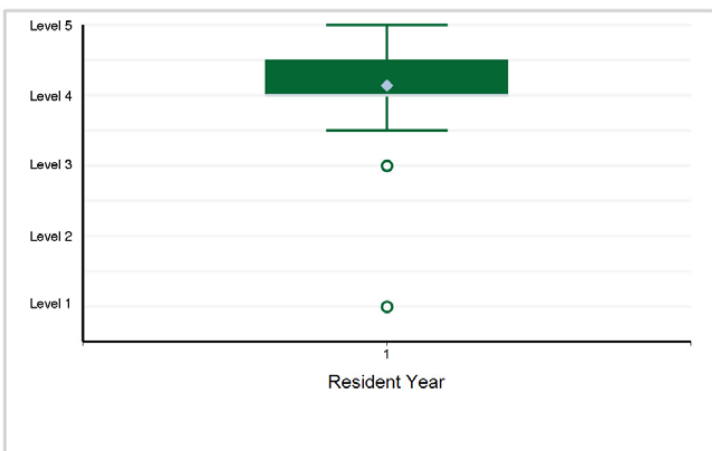

12. Professionalism - Professionalism: Commitment to Institution, Department, and Colleagues

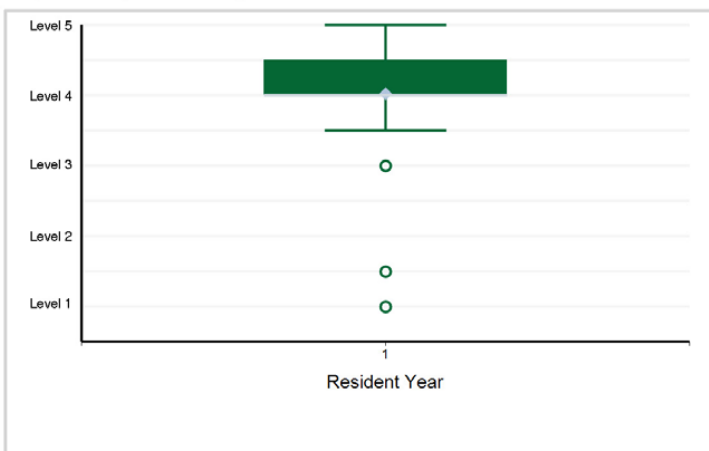

Specialty Box Plot Report - Milestone Evaluation by Resident Year: Year-End 2021-2022

SUBSPECIALTY: Obstetric Anesthesiology

13. Professionalism - Professionalism: Receiving and Giving of Feedback



14. Professionalism - Professionalism: Responsibility to Maintain Personal, Emotional, Physical, and Mental Health

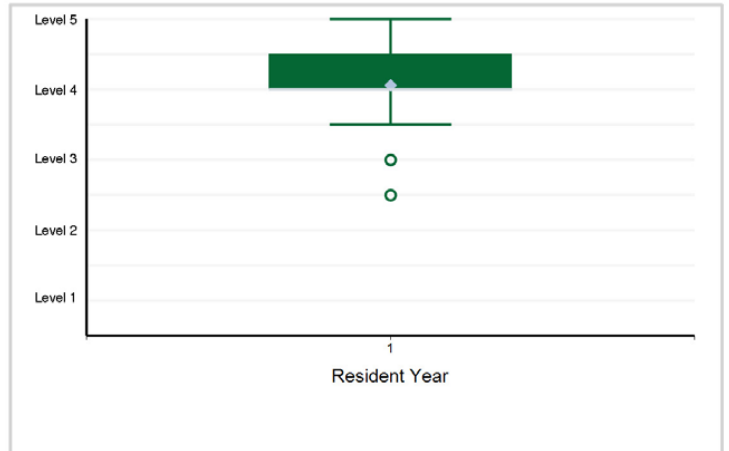

15. Interpersonal and Communication Skills - Interpersonal and Communications Skills: Communication with Patients and Families

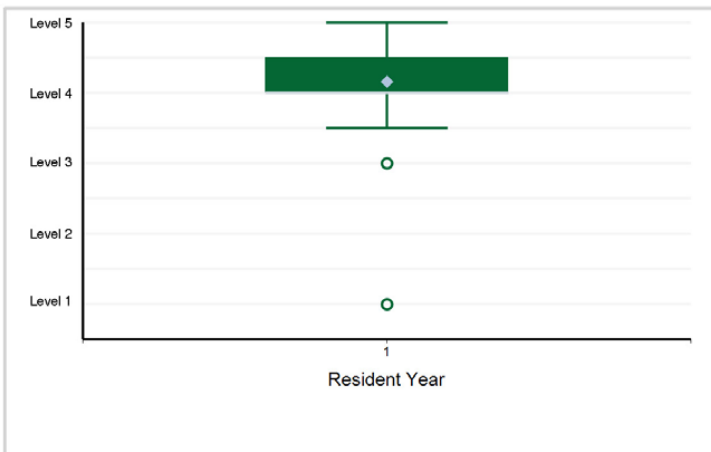

Specialty Box Plot Report - Milestone Evaluation by Resident Year: Year-End 2021-2022

TABLE 10: SUBSPECIALTY: **Pain Medicine (multidisciplinary, Anesthesiology)**

Resident Year	1	Total Residents*
# of Residents	419	419

*Note: There are 3 residents with an incomplete milestone evaluation that are excluded from the box plots below.

1. Patient Care - Patient Care – Gathers and Synthesizes Essential and Accurate Information to Define Each ...

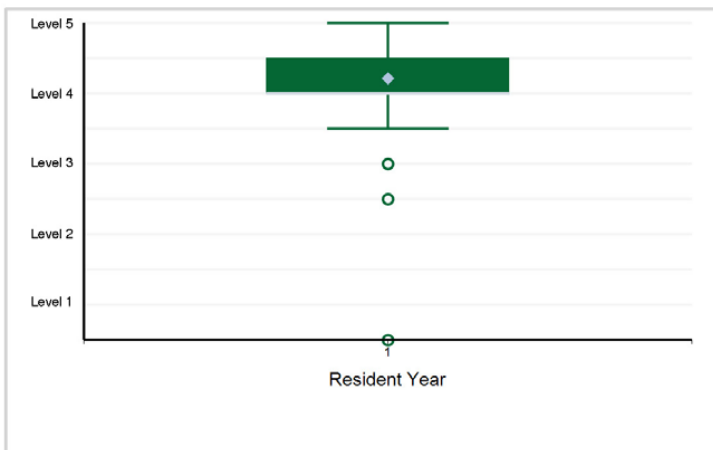

2. Patient Care - Patient Care – Gathers and Synthesizes Essential and Accurate Information to Define Each ...

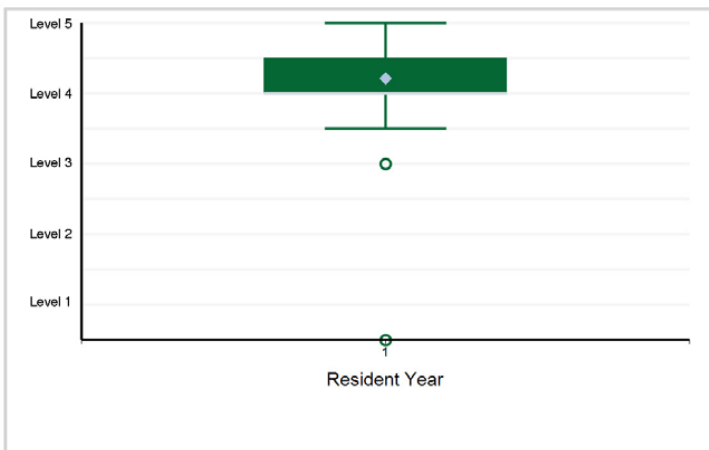

3. Patient Care - Patient Care – Gathers and Synthesizes Essential and Accurate Information to Define Each ...

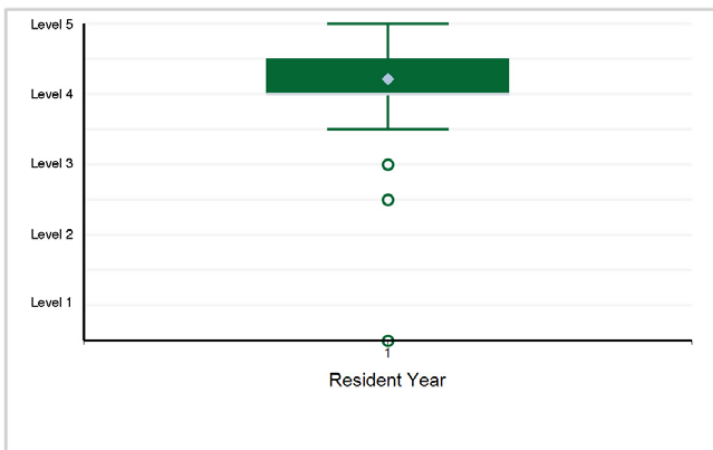

4. Patient Care - Patient Care – In Collaboration with the Patient, Develops and Achieves a Comprehensive ...

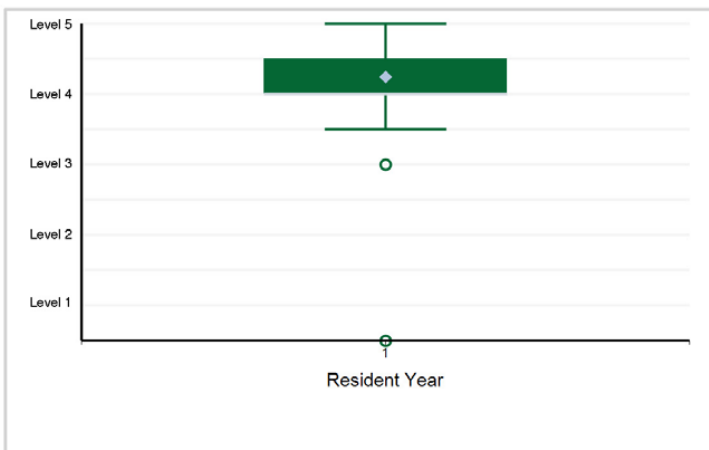

5. Patient Care - Patient Care – Demonstrates Skill in Performing and Interpreting Diagnostic and Therapeutic ...

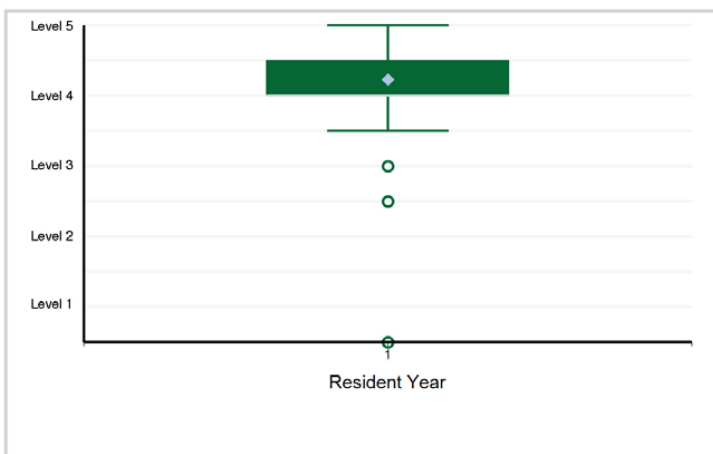

6. Patient Care - Patient Care – Requests and Provides Consultative Care

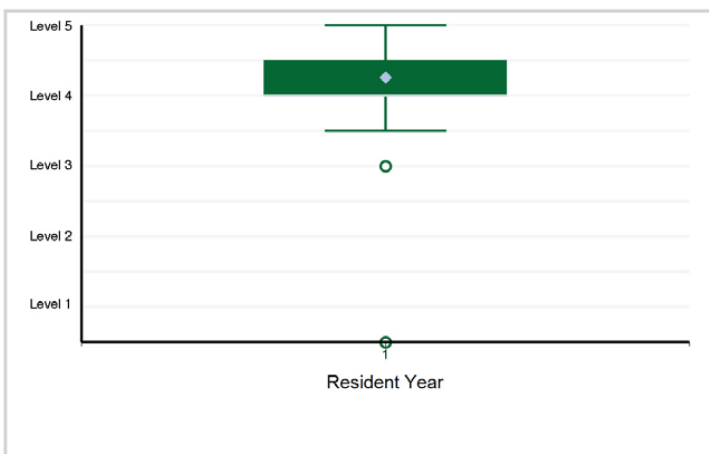

Specialty Box Plot Report - Milestone Evaluation by Resident Year: Year-End 2021-2022

SUBSPECIALTY: Pain Medicine (multidisciplinary, Anesthesiology)

7. Medical Knowledge - Medical Knowledge – Possesses Clinical Knowledge • Anatomy, physiology, and pharmacology ...

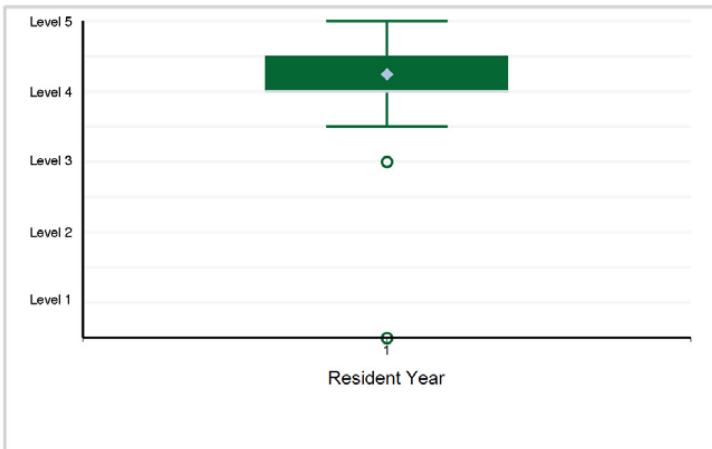

8. Medical Knowledge - Medical Knowledge – Demonstrates Knowledge of Diagnostic Laboratory, Diagnostic ...

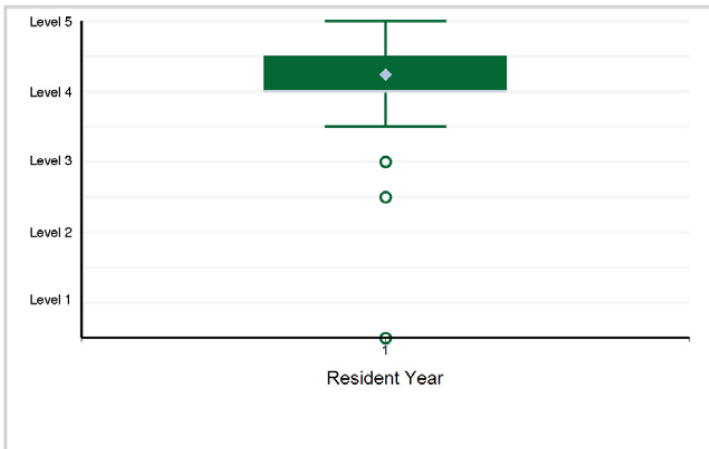

9. Medical Knowledge - Medical Knowledge – Participates in Scholarship (Foundation, Investigation, Analysis, and Dissemination)

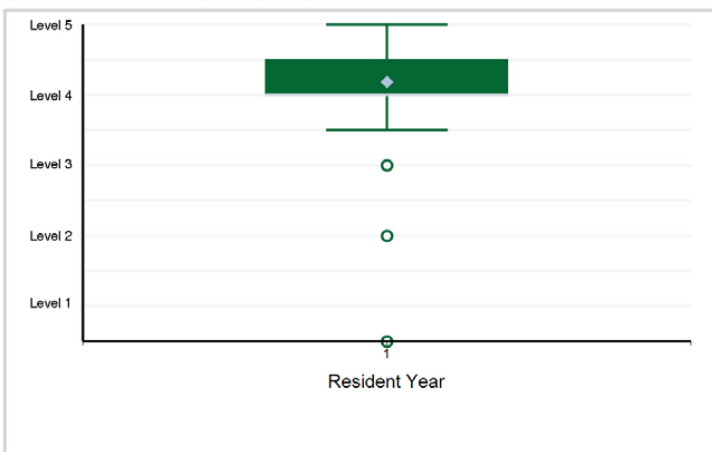

10. Systems-Based Practice - Systems-Based Practice – Works Effectively Within an Interprofessional Team (e.g., with peers, ...

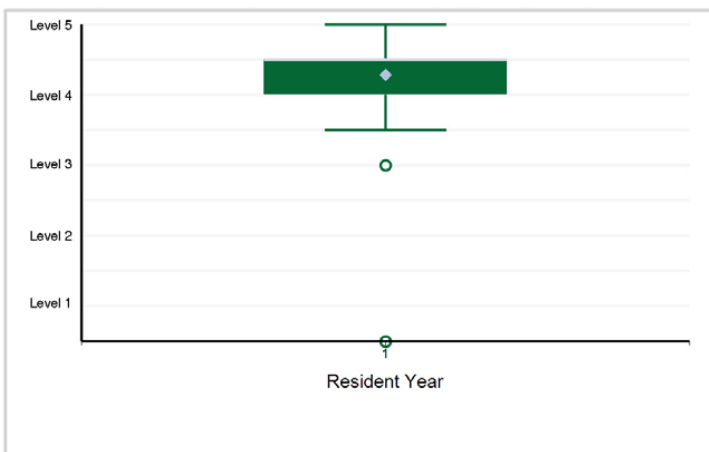

11. Systems-Based Practice - Systems-Based Practice – Recognizes System-based Error and Advocates for System Improvement

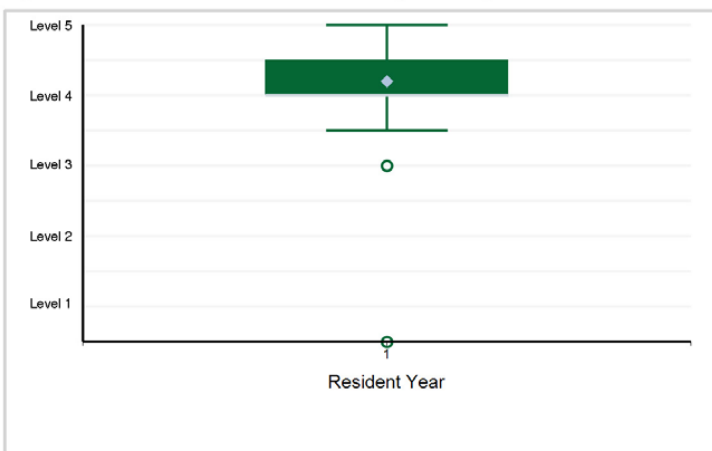

12. Systems-Based Practice - Systems-Based Practice – Identifies Forces that Impact the Cost of Health Care, ...

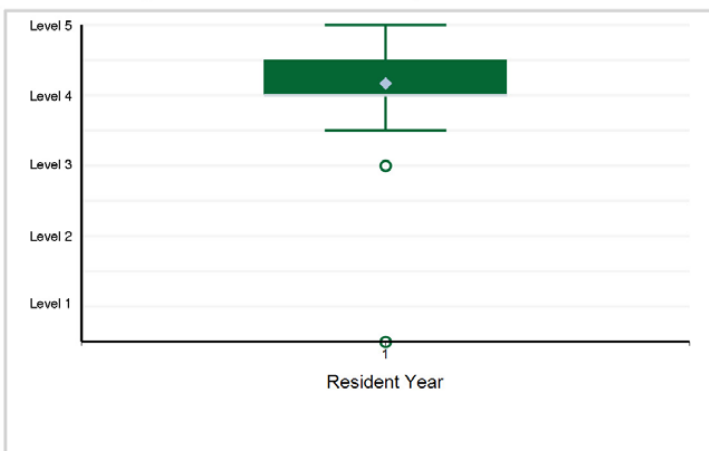

Specialty Box Plot Report - Milestone Evaluation by Resident Year: Year-End 2021-2022

SUBSPECIALTY: Pain Medicine (multidisciplinary, Anesthesiology)

13. Systems-Based Practice - Systems-Based Practice – Transitions Patients Effectively Within and Across Health Delivery Systems

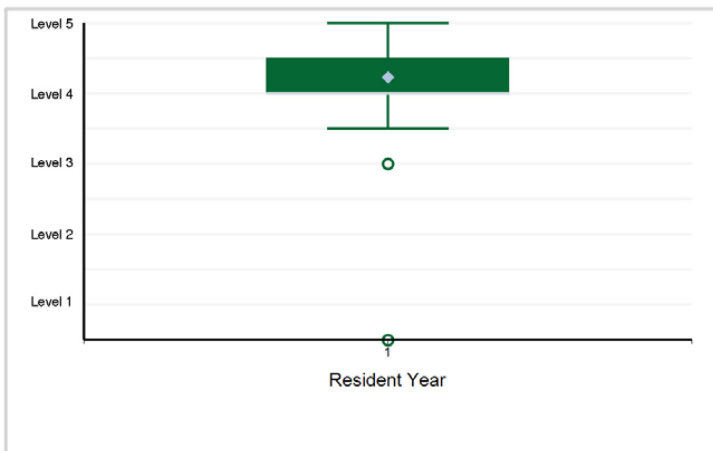

14. Practice-Based Learning and Improvement - Practice-Based Learning and Improvement – Monitors Practice with a Goal for Improvement

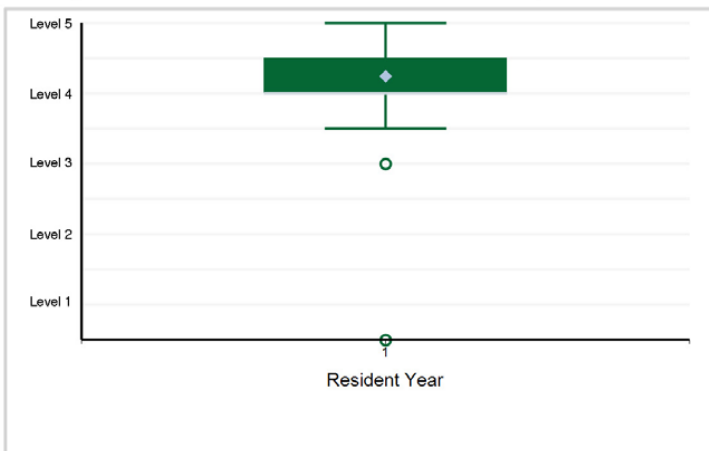

15. Practice-Based Learning and Improvement - Practice-Based Learning and Improvement – Learns and Improves via Performance ...

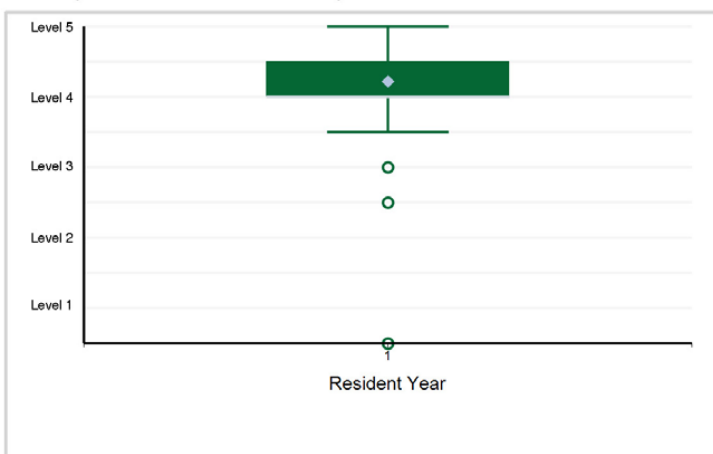

16. Practice-Based Learning and Improvement - Practice-Based Learning and Improvement – Learns and Improves via Feedback

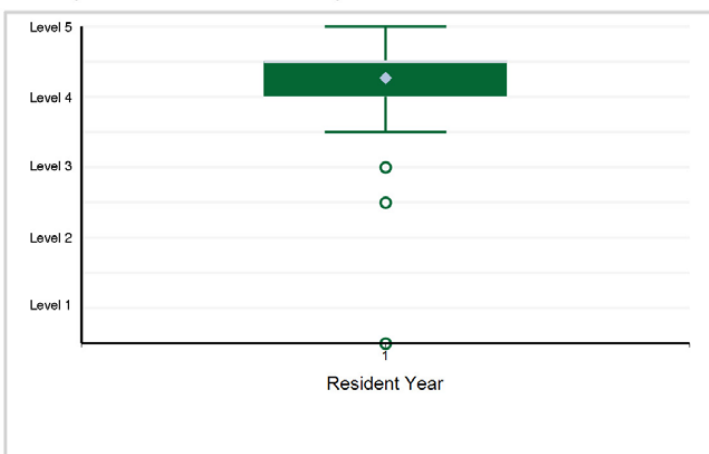

17. Practice-Based Learning and Improvement - Practice-Based Learning and Improvement – Learns and Improves at the Point of ...

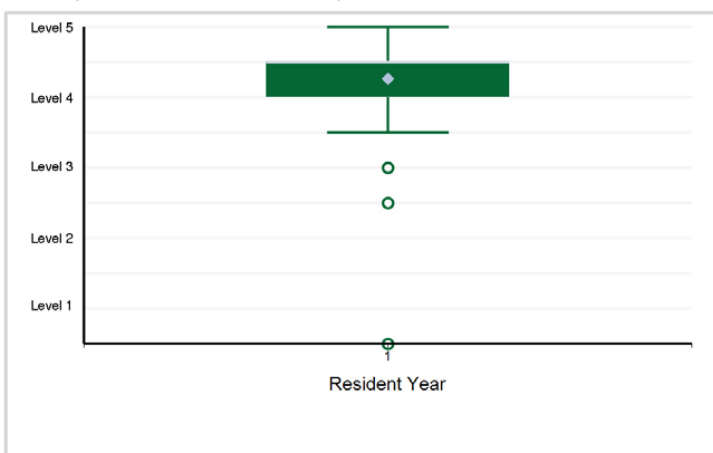

18. Professionalism - Professionalism – Has Professional and Respectful Interactions with Patients, Caregivers, and Members ...

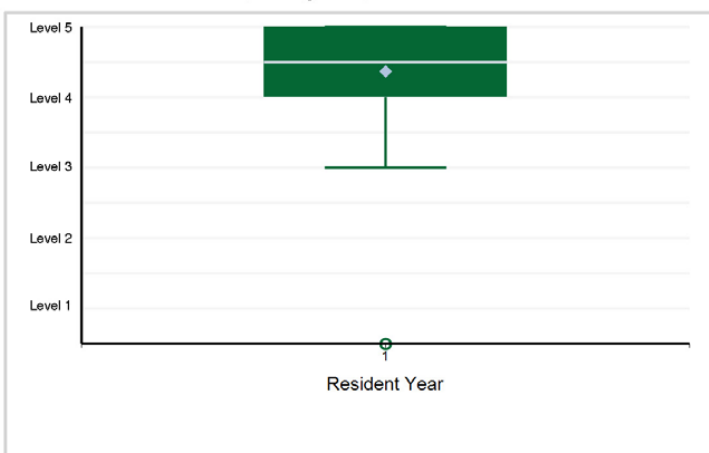

Specialty Box Plot Report - Milestone Evaluation by Resident Year: Year-End 2021-2022

SUBSPECIALTY: Pain Medicine (multidisciplinary, Anesthesiology)

19. Professionalism - Professionalism – Accepts Responsibility and Follows through on Tasks

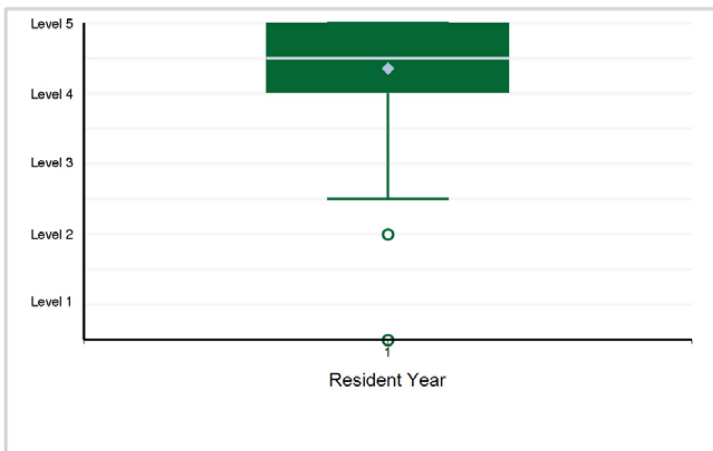

20. Professionalism - Professionalism – Responds to each Patient's Unique Characteristics and Needs

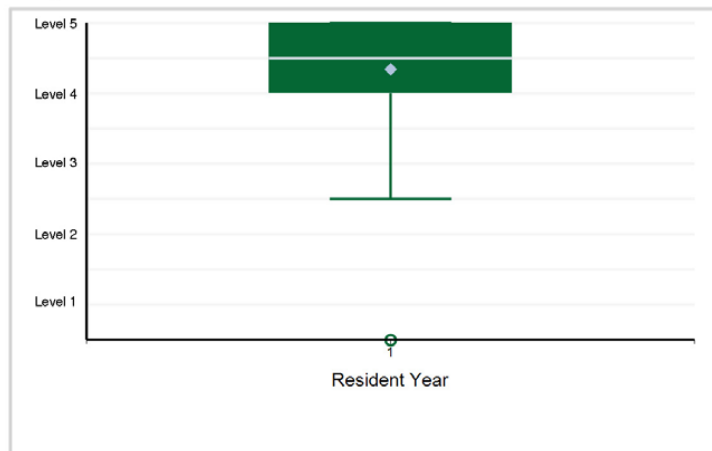

21. Professionalism - Professionalism – Exhibits Integrity and Ethical Behavior in Professional Conduct

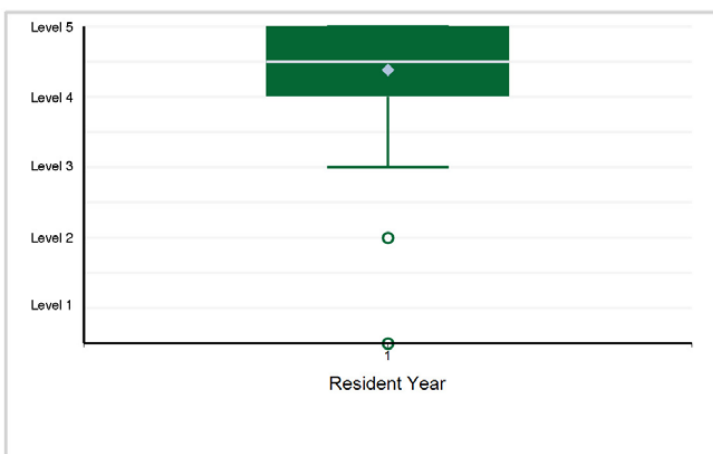

22. Interpersonal and Communication Skills - Interpersonal and Communication Skills – Communicates Effectively ...

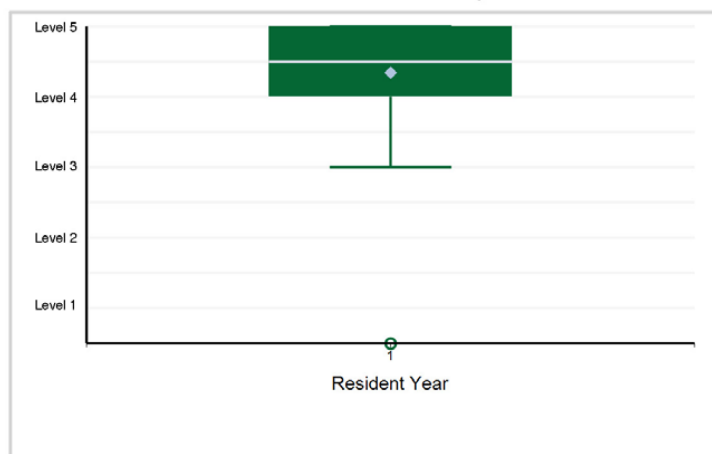

23. Interpersonal and Communication Skills - Interpersonal and Communication Skills – Communicates Effectively ...

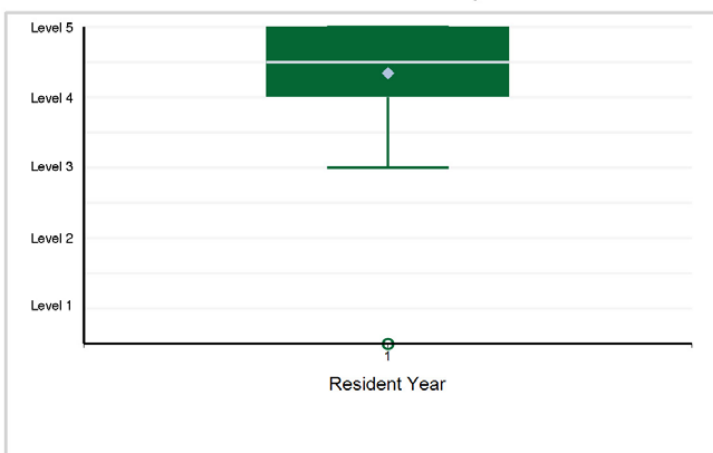

24. Interpersonal and Communication Skills - Interpersonal and Communication Skills – Appropriately Utilizes and Completion ...

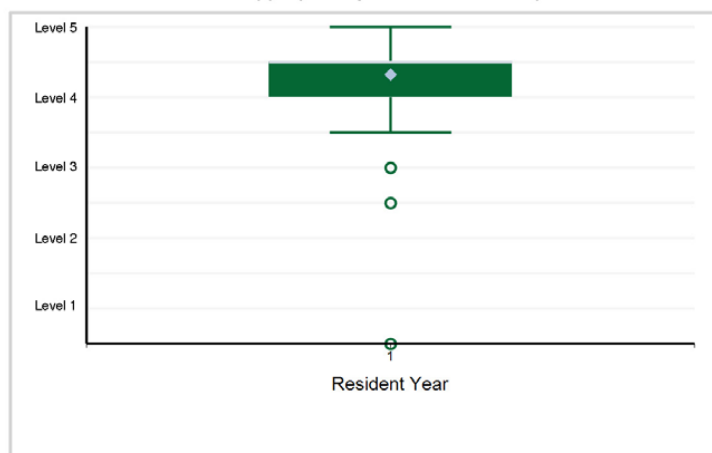

Specialty Box Plot Report - Milestone Evaluation by Resident Year: Year-End 2021-2022

TABLE 11: SUBSPECIALTY: **Pediatric Anesthesiology**

Resident Year	1	Total Residents
# of Residents	209	209

1. Patient Care - Patient Care: Pre-Anesthetic Patient Evaluation, Assessment, and Preparation

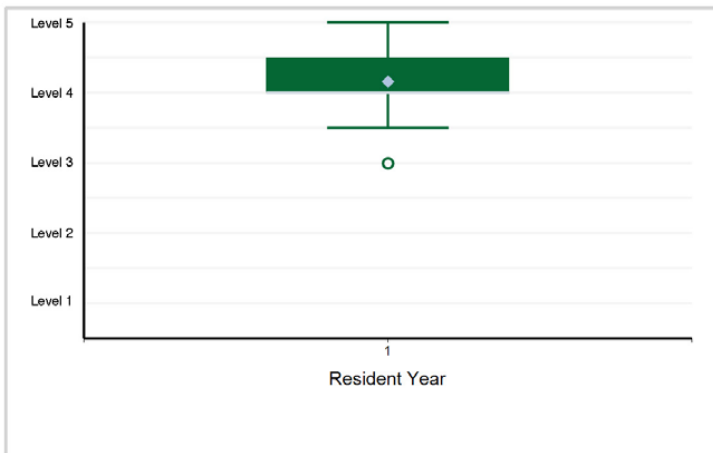

2. Patient Care - Patient Care: Technical Skills

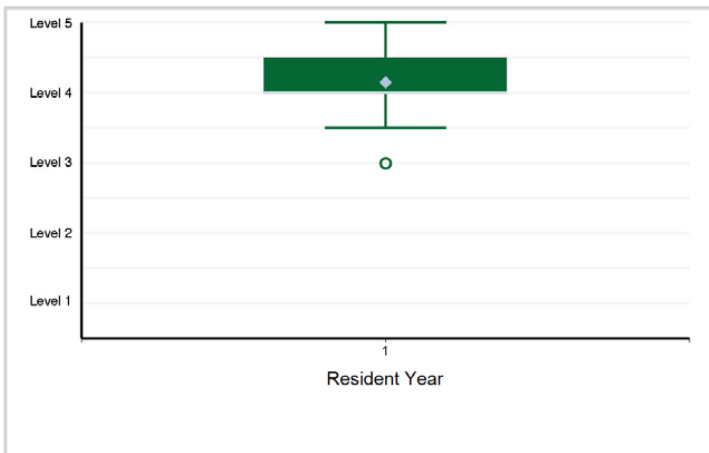

3. Patient Care - Patient Care: Perioperative Planning and Management

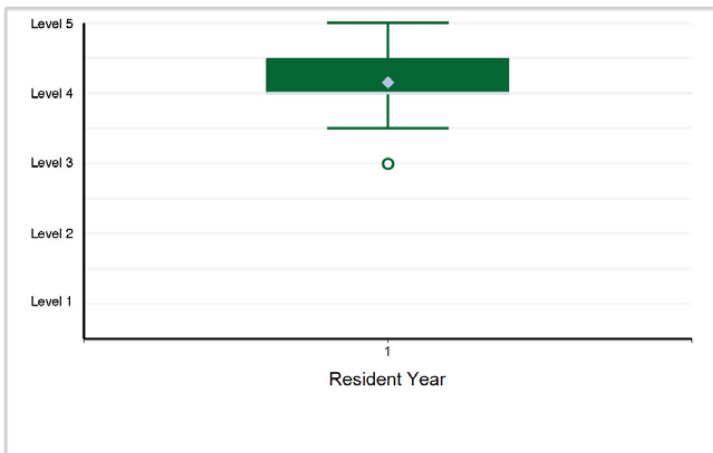

4. Medical Knowledge - Medical Knowledge: Knowledge of Biomedical, Epidemiologic, and Developmental Sciences ...

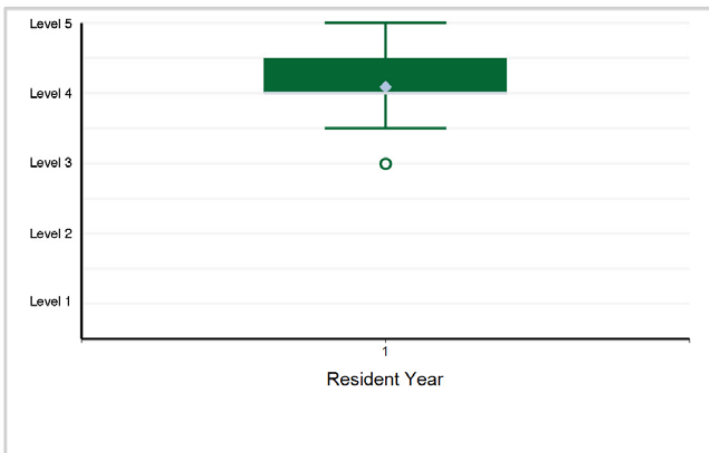

5. Medical Knowledge - Medical Knowledge: Knowledge of Clinical and Behavioral Sciences related to Pediatric Anesthesiology

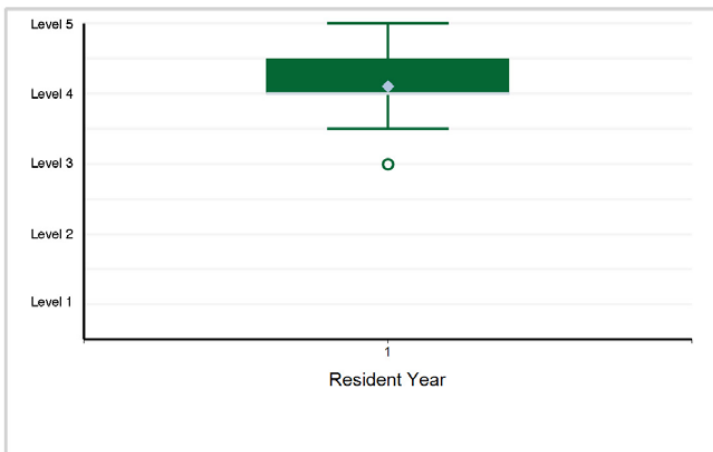

6. Systems-Based Practice - Systems-Based Practice: Interdisciplinary and Transition of Care

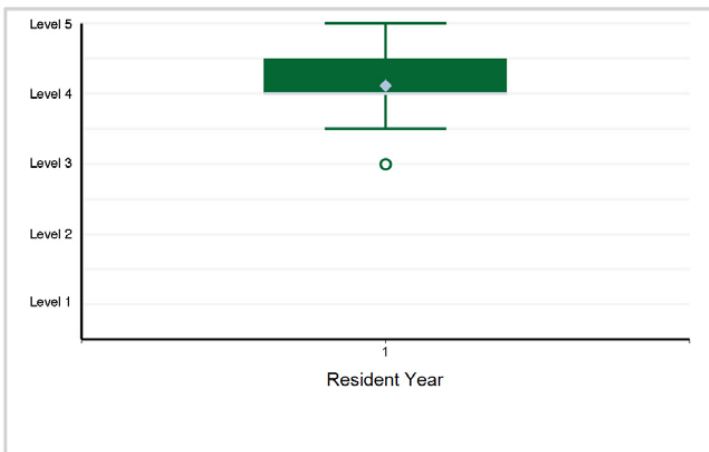

Specialty Box Plot Report - Milestone Evaluation by Resident Year: Year-End 2021-2022

SUBSPECIALTY: Pediatric Anesthesiology

7. Systems-Based Practice - Systems-Based Practice: Incorporation of Patient Safety and Quality Improvement into Clinical Practice

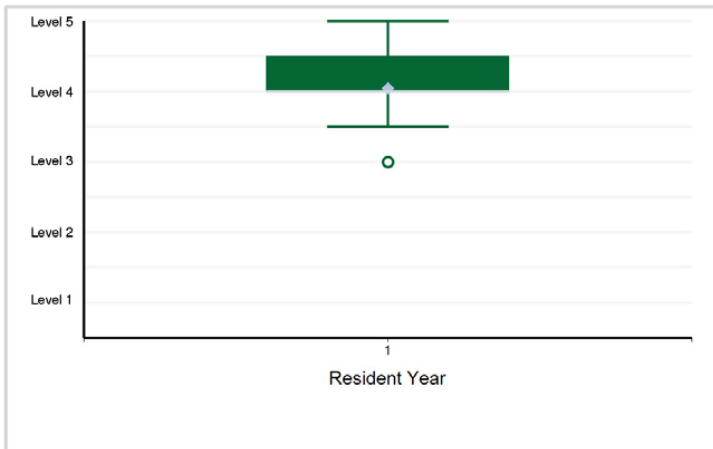

8. Systems-Based Practice - Systems-Based Practice: Understanding of Health Care Economics: Cost Awareness ...

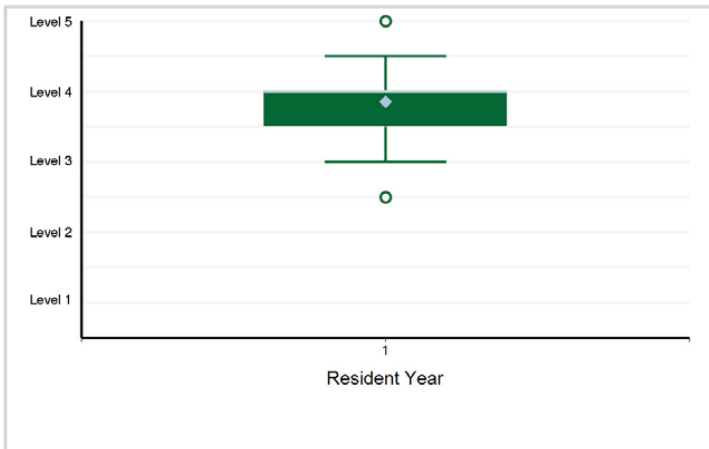

9. Practice-Based Learning and Improvement - Practice-Based Learning and Improvement: Self-directed Learning and Scholarly ...

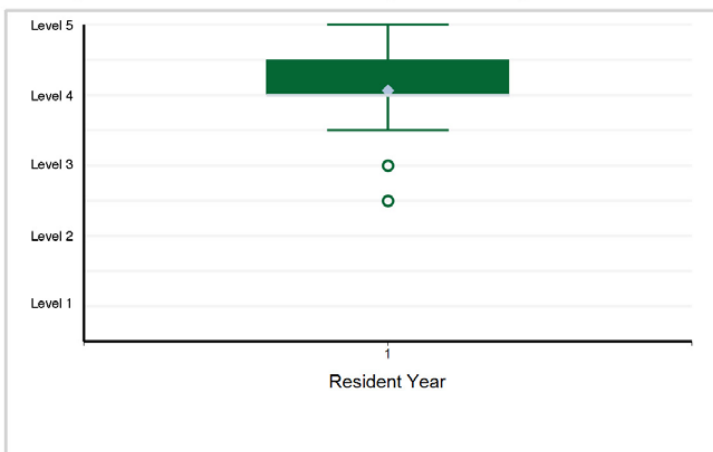

10. Practice-Based Learning and Improvement - Practice-Based Learning and Improvement: Education of Team ...

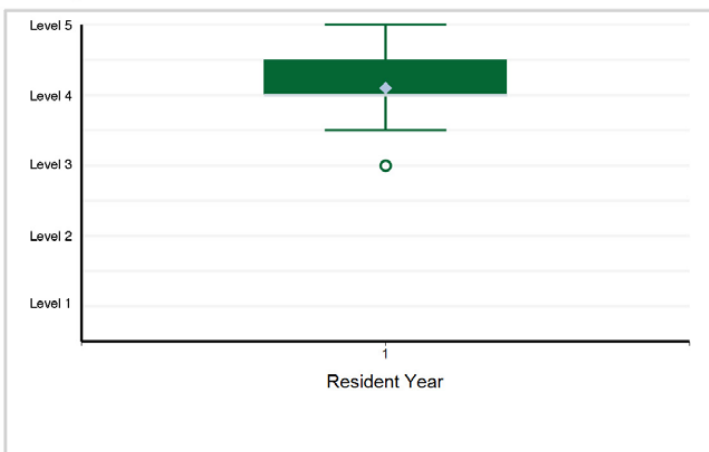

11. Professionalism - Professionalism: Commitment to Institution, Department, and Colleagues

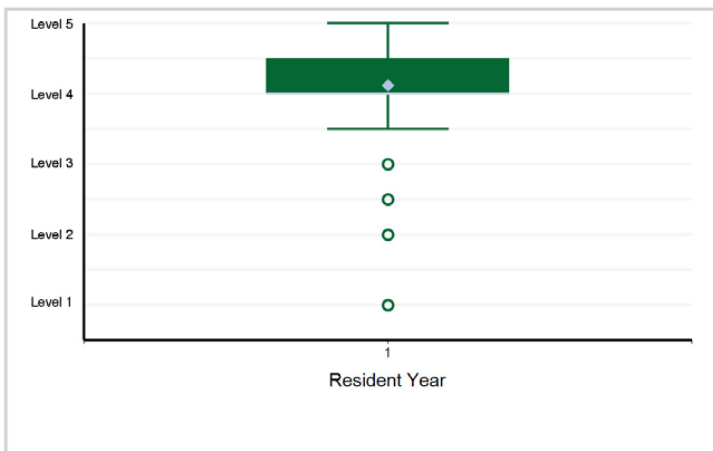

12. Professionalism - Professionalism: Receiving and Giving of Feedback

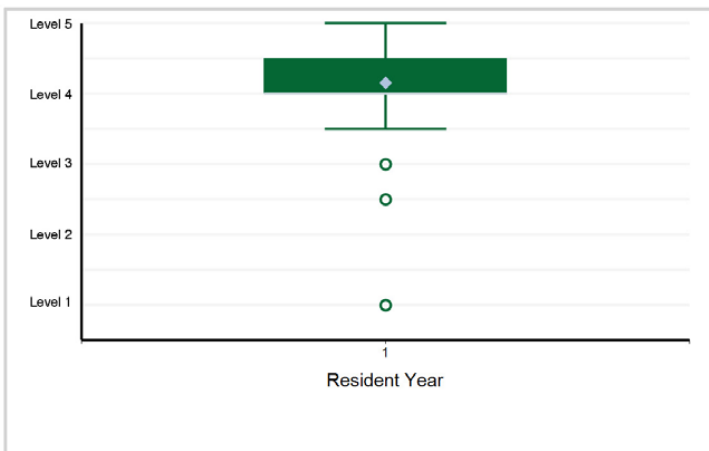

Specialty Box Plot Report - Milestone Evaluation by Resident Year: Year-End 2021-2022

SUBSPECIALTY: Pediatric Anesthesiology

13. Professionalism - Professionalism: Responsibility to Maintain Personal Emotional, Physical, and Mental Health

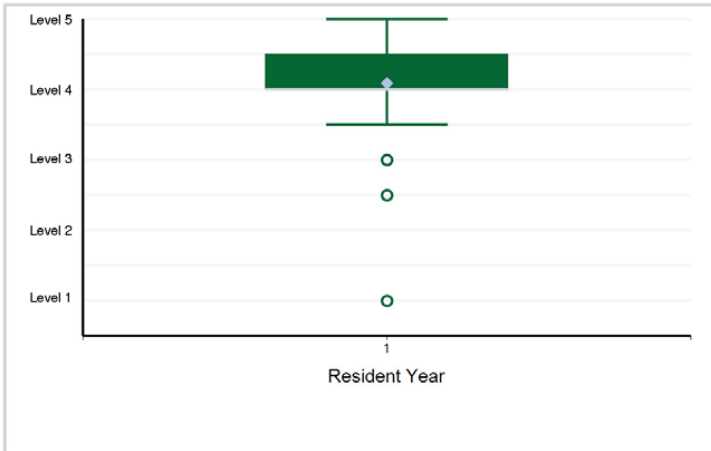

14. Interpersonal and Communication Skills - Interpersonal and Communications Skills: Communication with Patients and Families

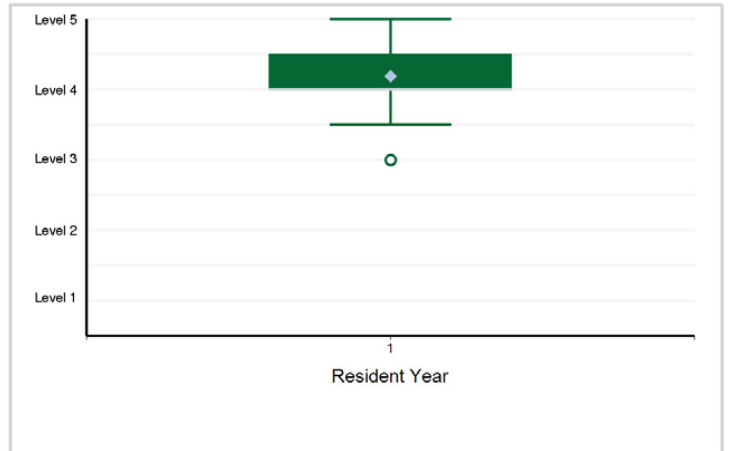

Specialty Box Plot Report - Milestone Evaluation by Resident Year: Year-End 2021-2022

TABLE 12: SUBSPECIALTY: **Regional Anesthesiology and Acute Pain Medicine**

Resident Year	1	Total Residents
# of Residents	89	89

1. Patient Care - Patient Care 1: Peri-Procedural Assessment and Management

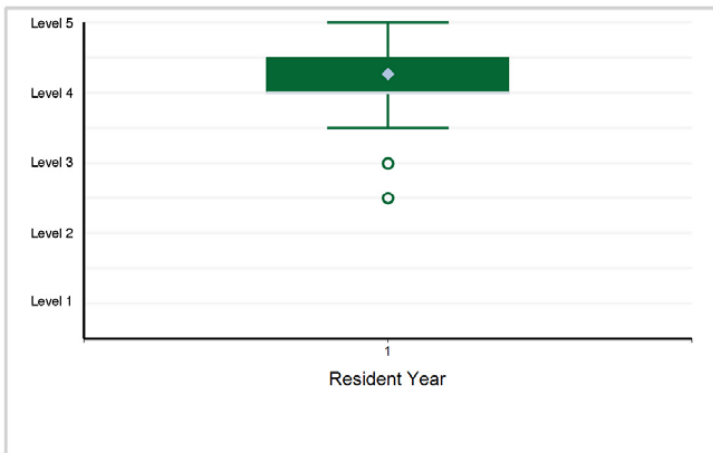

2. Patient Care - Patient Care 2: Acute Pain Management

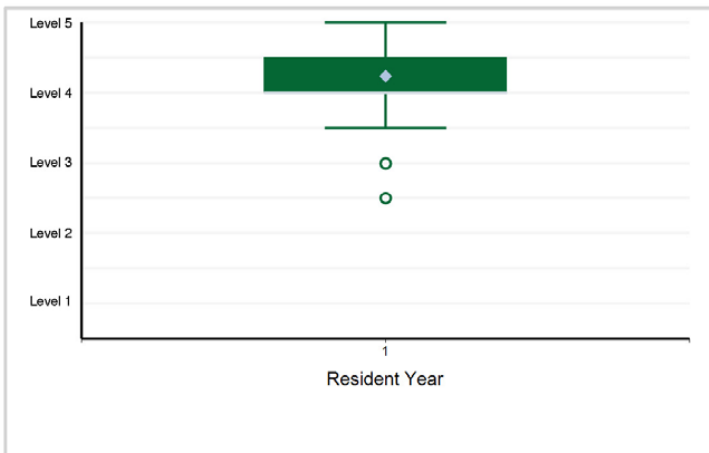

3. Patient Care - Patient Care 3: Technical/Procedural Skills

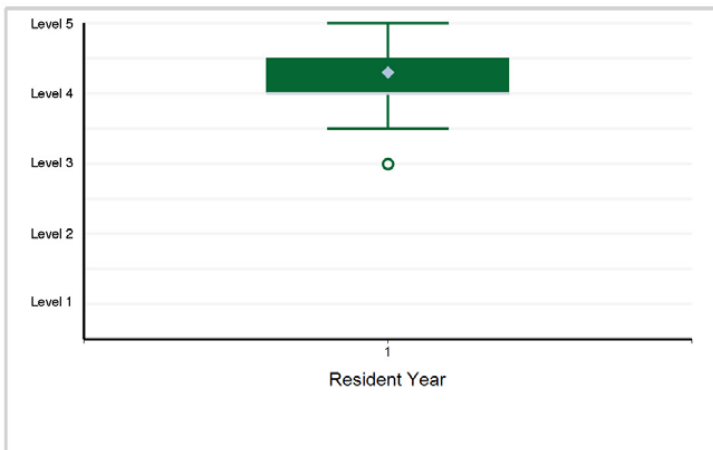

4. Medical Knowledge - Medical Knowledge 1: Anatomy, Physiology, and Pharmacology

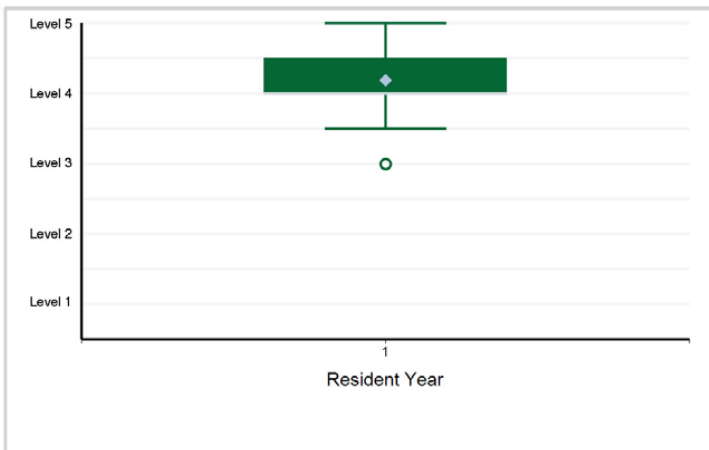

5. Medical Knowledge - Medical Knowledge 2: Procedures and Techniques (includes indications and contraindications, ...)

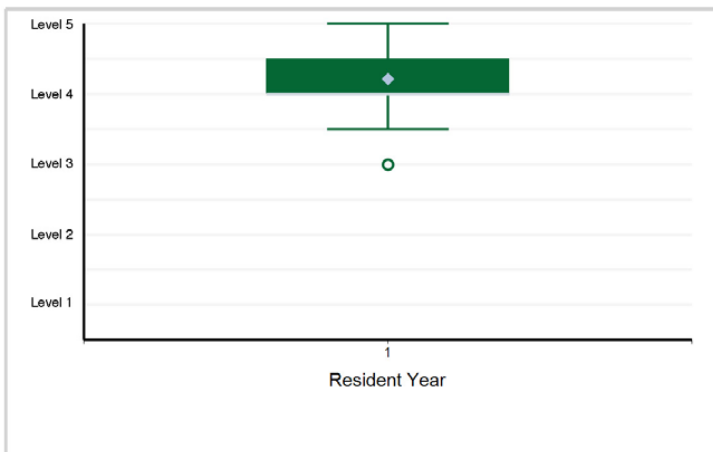

6. Medical Knowledge - Medical Knowledge 3: Assessment of Acute Pain

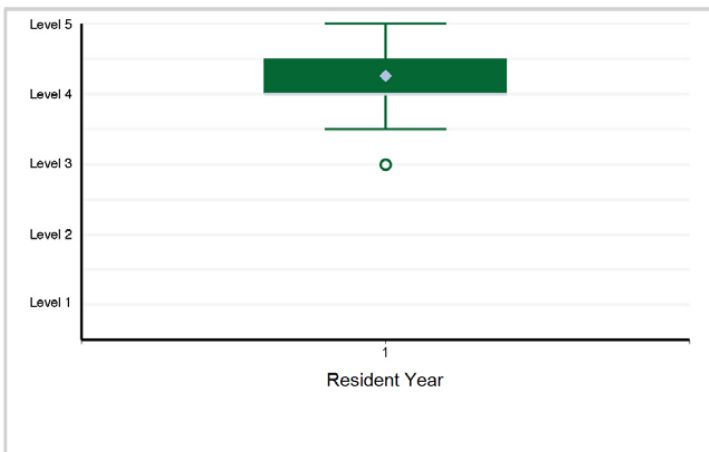

Specialty Box Plot Report - Milestone Evaluation by Resident Year: Year-End 2021-2022

SUBSPECIALTY: Regional Anesthesiology and Acute Pain Medicine

7. Systems-Based Practice - Systems-based Practice 1: Patient Safety and Quality Improvement

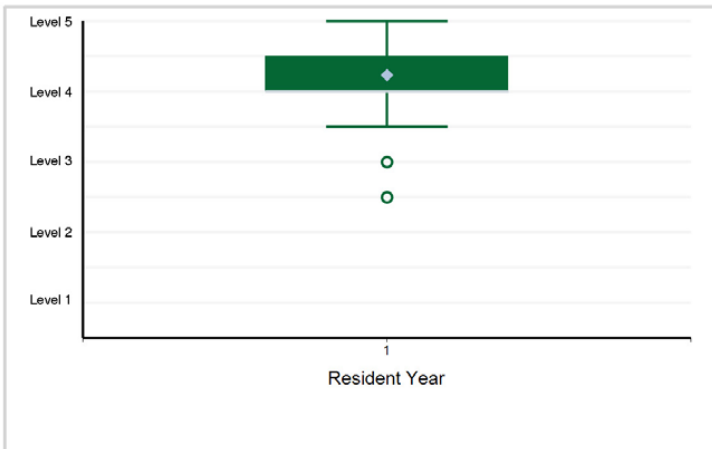

8. Systems-Based Practice - Systems-based Practice 2: System Navigation for Patient-Centered Care

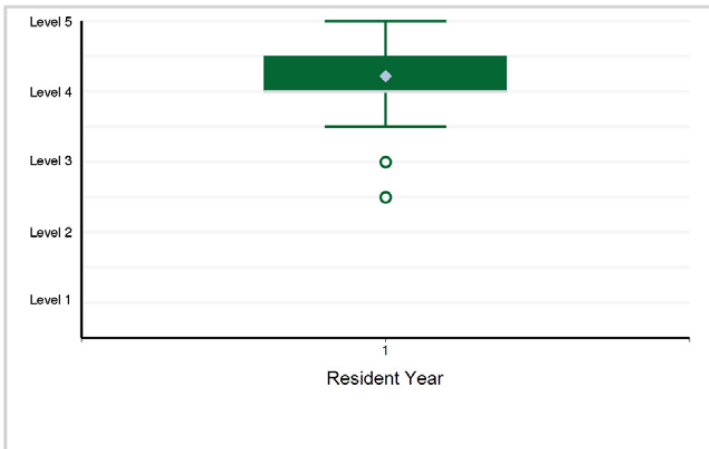

9. Systems-based Practice - Systems-based Practice 3: Physician Role in Health Care Systems

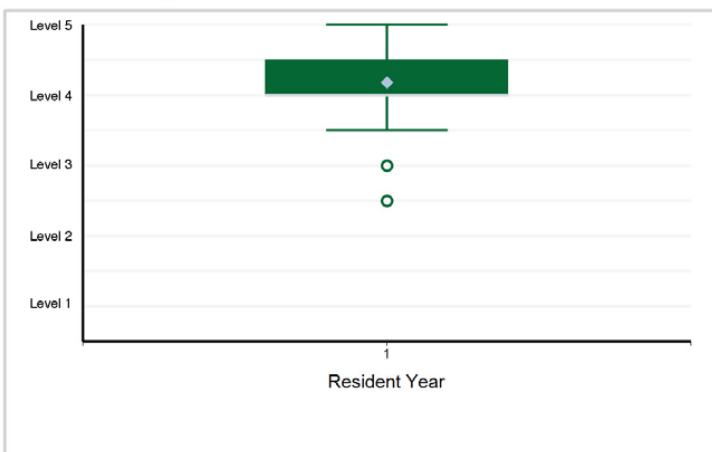

10. Practice-based Learning and Improvement - Practice-based Learning and Improvement 1: Evidence-Based and Informed Practice

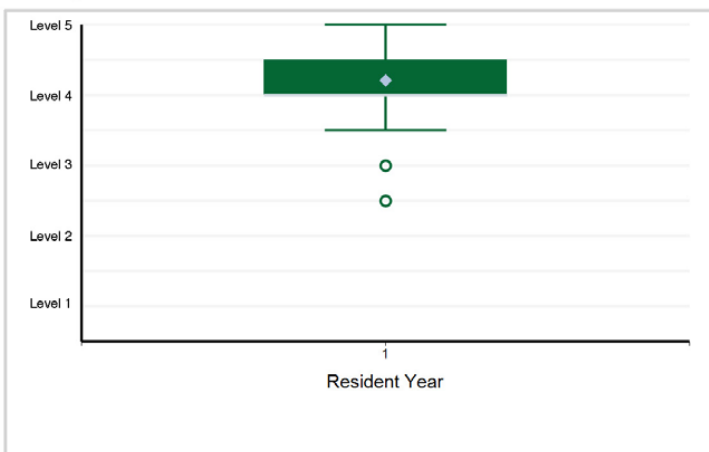

11. Practice-based Learning and Improvement - Practice-based Learning and Improvement 2: Reflective Practice and Commitment ...

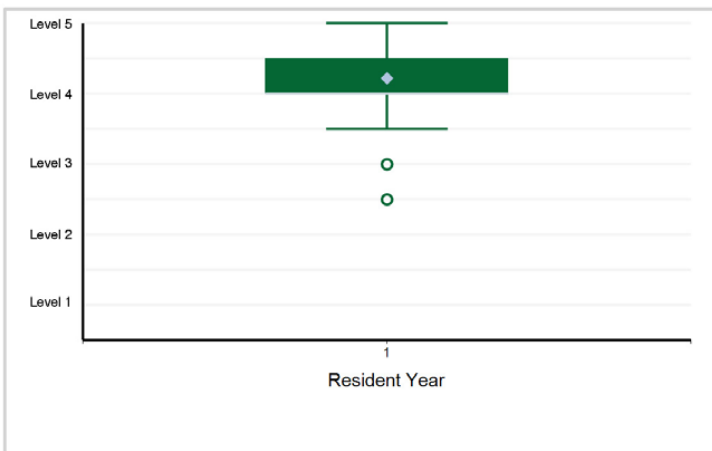

12. Professionalism - Professionalism 1: Professional Behavior and Ethical Principles

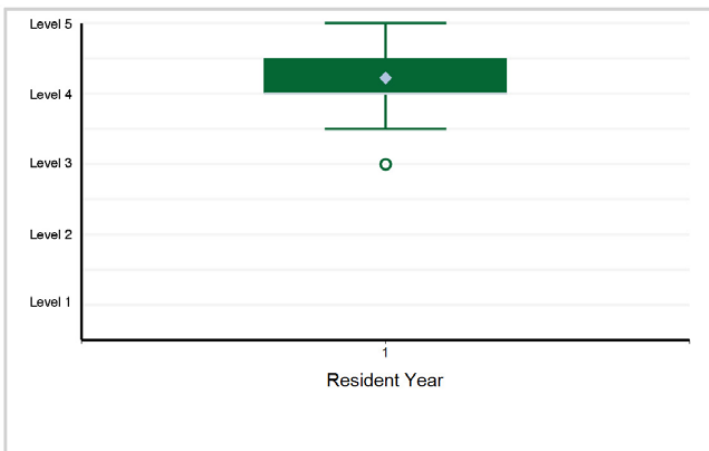

Specialty Box Plot Report - Milestone Evaluation by Resident Year: Year-End 2021-2022

SUBSPECIALTY: Regional Anesthesiology and Acute Pain Medicine

13. Professionalism - Professionalism 2: Accountability/Conscientiousness

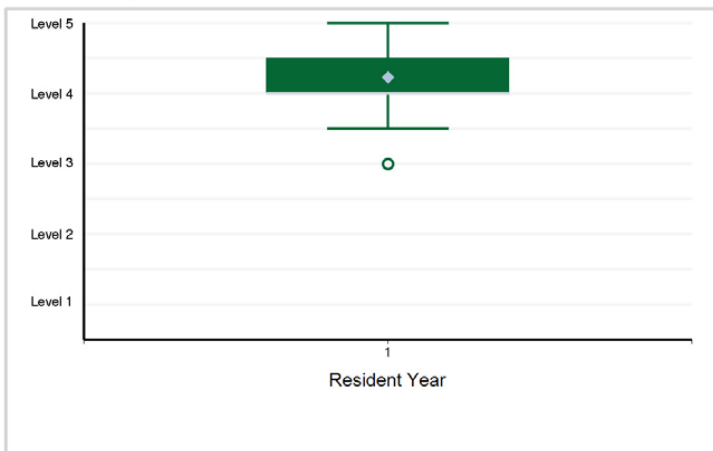

14. Professionalism - Professionalism 3: Self-Awareness and Help-Seeking

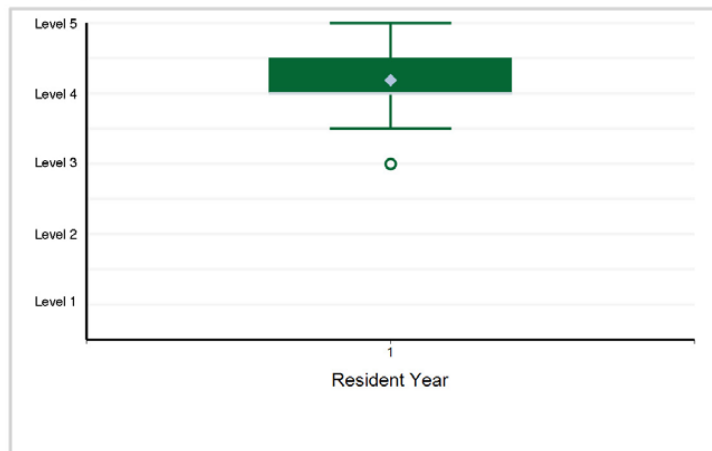

15. Interpersonal and Communication Skills - Interpersonal and Communication Skills 1: Patient- and Family-Centered Communication

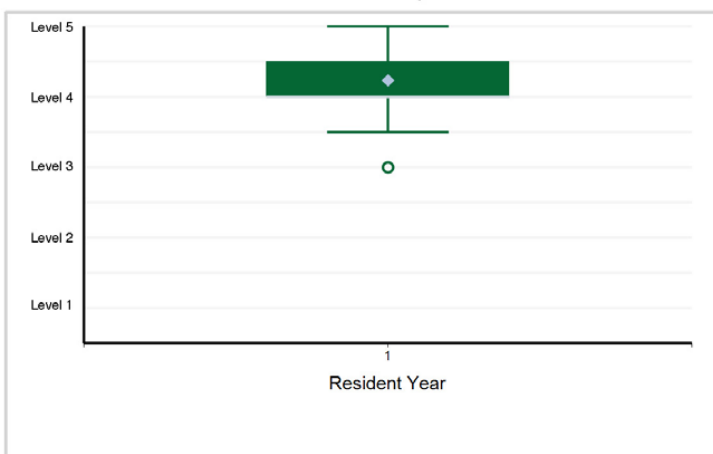

16. Interpersonal and Communication Skills - Interpersonal and Communication Skills 2: Interprofessional and Team Communication

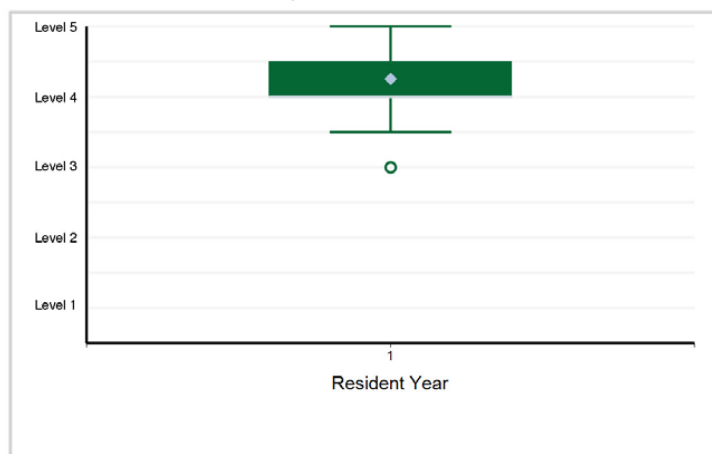

17. Interpersonal and Communication Skills - Interpersonal and Communication Skills 3: Communication within Health Care Systems

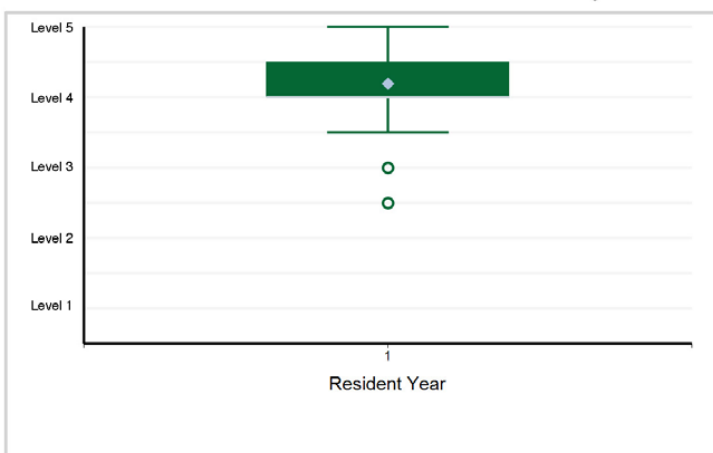

Specialty Box Plot Report - Milestone Evaluation by Resident Year: Year-End 2021-2022

TABLE 13: SPECIALTY: **Colon and Rectal Surgery**

Resident Year	1	Total Residents
# of Residents	108	108

1. Patient Care - Patient Care 1: Rectal Cancer

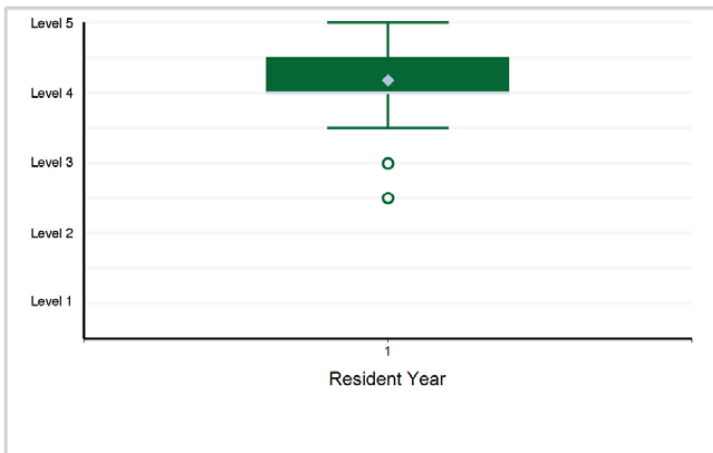

2. Patient Care - Patient Care 2: Colonic Neoplasia (Polyps, Colon Cancer, Polyposis)

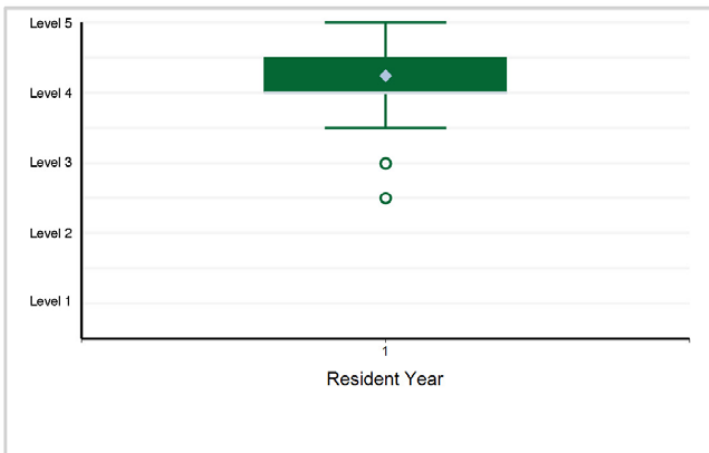

3. Patient Care - Patient Care 3: Anal Cancer

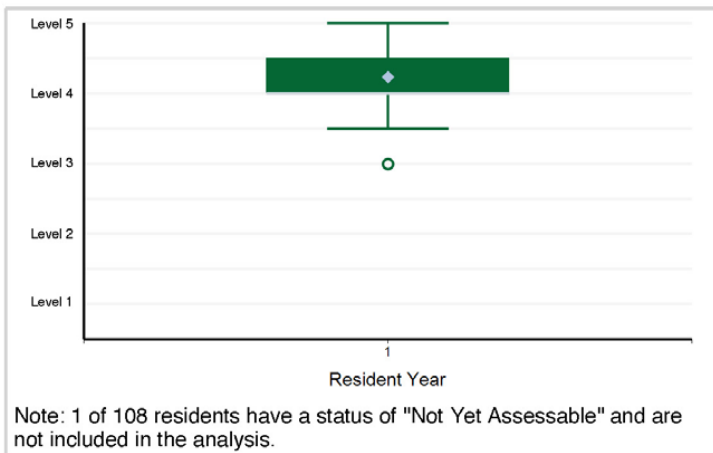

4. Patient Care - Patient Care 4: Anal Fistula



5. Patient Care - Patient Care 5: Benign Anorectal (Hemorrhoids, Fissures, Abscess, Pilonidal Disease, and Dermatologic Conditions)

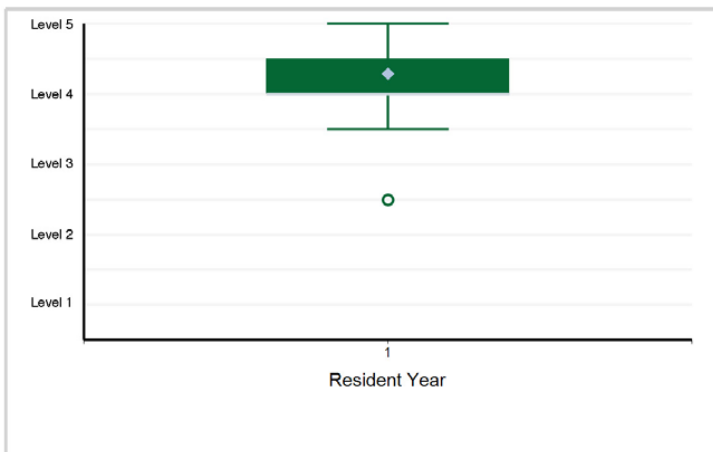

6. Patient Care - Patient Care 6: Ulcerative Colitis

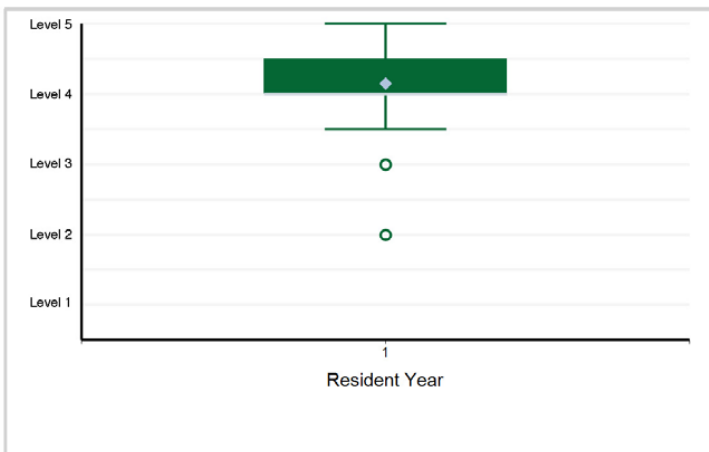

Specialty Box Plot Report - Milestone Evaluation by Resident Year: Year-End 2021-2022

SPECIALTY: Colon and Rectal Surgery

7. Patient Care - Patient Care 7: Diverticular Disease

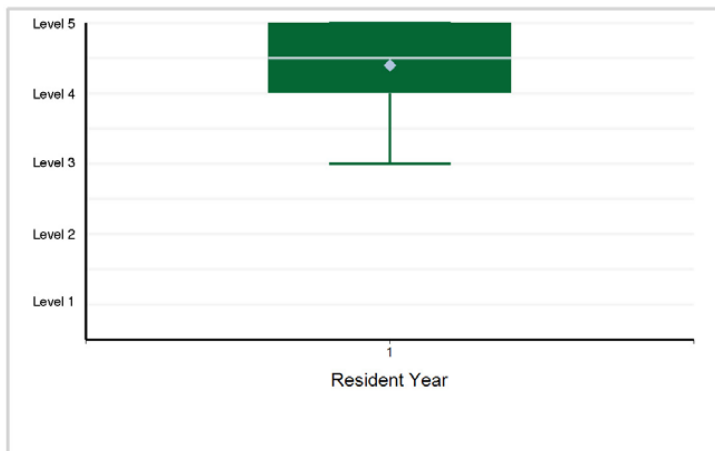

8. Patient Care - Patient Care 8: Benign Colon Disease (Lower Gastrointestinal (GI) Bleeding, Volvulus, ...)

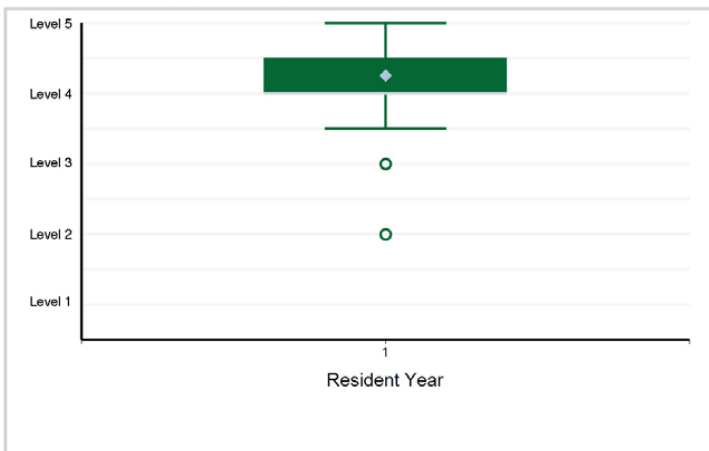

9. Patient Care - Patient Care 9: Pelvic Floor Disorders



10. Patient Care - Patient Care 10: Rectal Prolapse



11. Patient Care - Patient Care 11: Fecal Incontinence

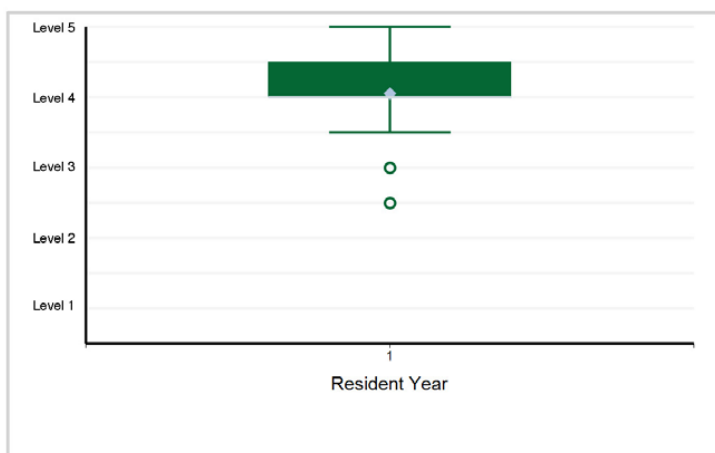

12. Patient Care - Patient Care 12: Endoscopy (Flexible Sigmoidoscopy and Colonoscopy)

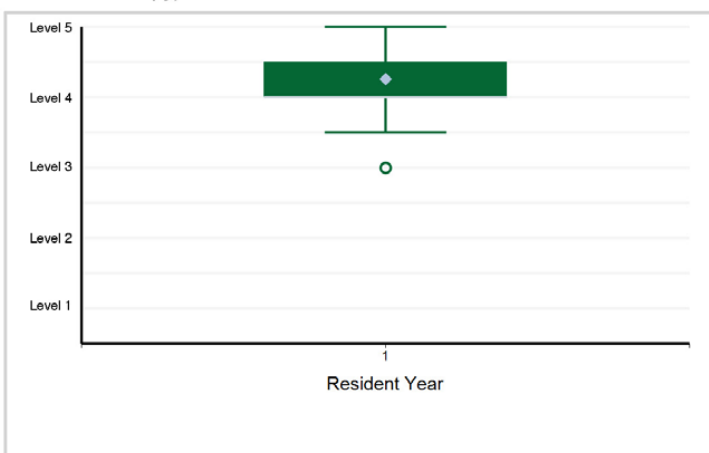

Specialty Box Plot Report - Milestone Evaluation by Resident Year: Year-End 2021-2022

SPECIALTY: Colon and Rectal Surgery

13. Patient Care - Patient Care 13: Crohn's Disease

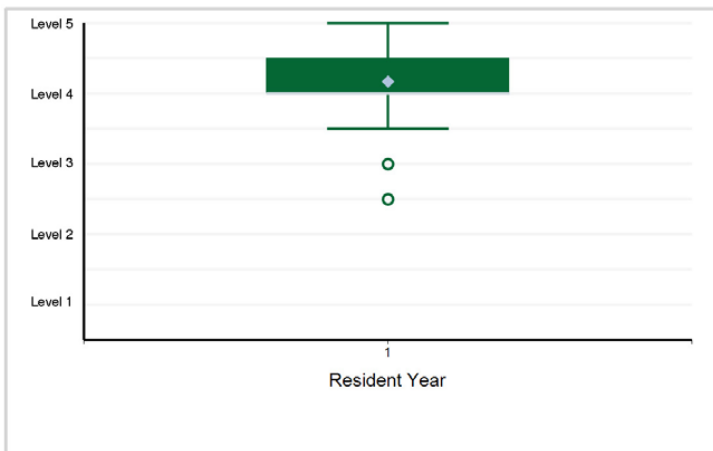

14. Medical Knowledge - Medical Knowledge 1: Anatomy, Pathophysiology and Treatment

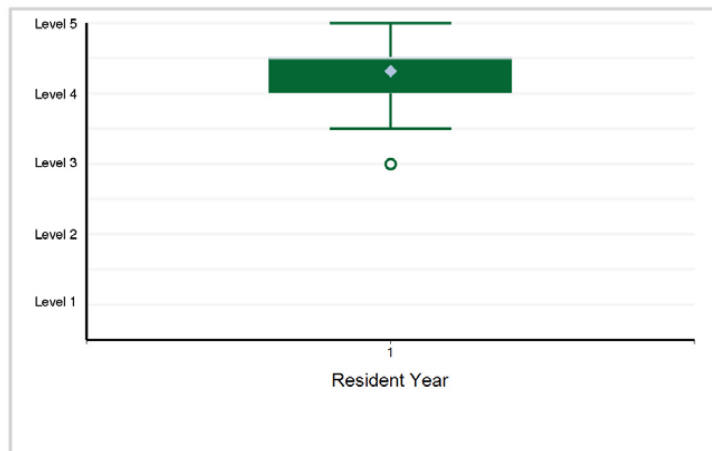

15. Medical Knowledge - Medical Knowledge 2: Critical Thinking for Diagnosis and Therapy

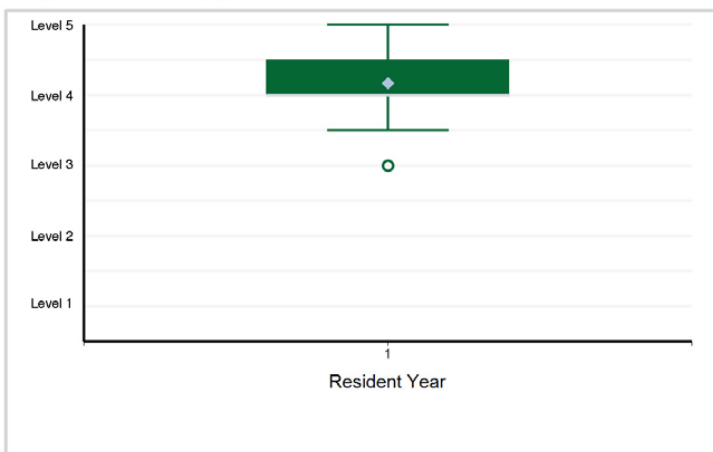

16. Systems-Based Practice - Systems-Based Practice 1: Patient Safety and Quality Improvement

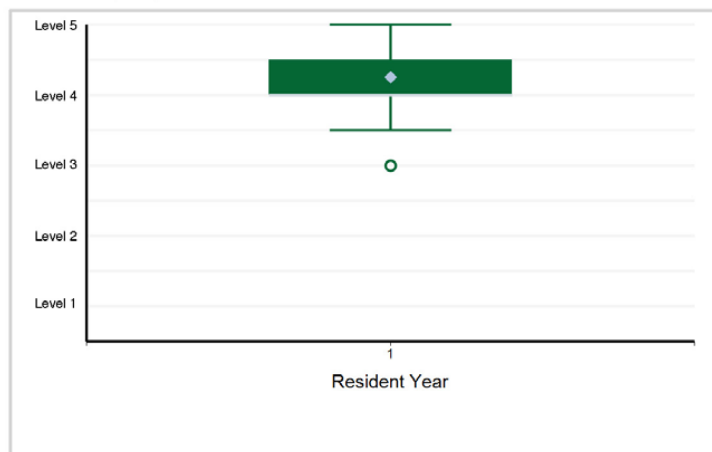

17. Systems-Based Practice - Systems-Based Practice 2: System Navigation for Patient-Centered Care

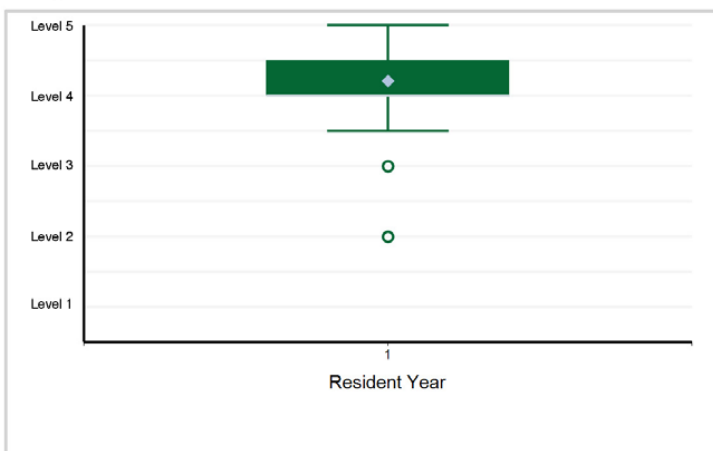

18. Systems-Based Practice - Systems-Based Practice 3: Physician Role in Health Care Systems

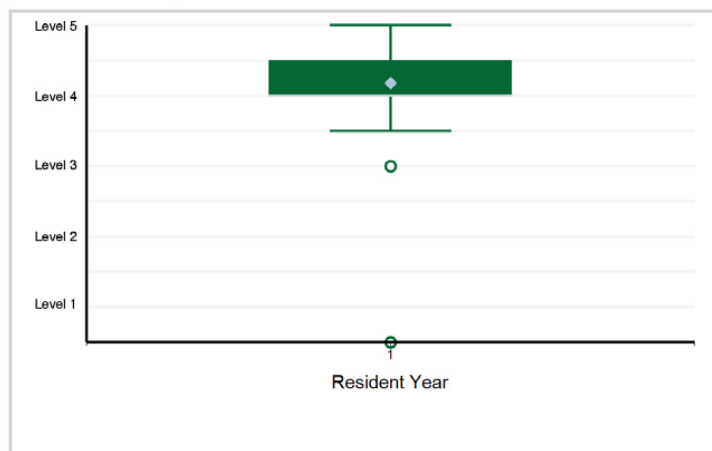

Specialty Box Plot Report - Milestone Evaluation by Resident Year: Year-End 2021-2022

SPECIALTY: Colon and Rectal Surgery

19. Practice-Based Learning and Improvement - Practice-Based Learning and Improvement 1: Evidence-Based and Informed Practice

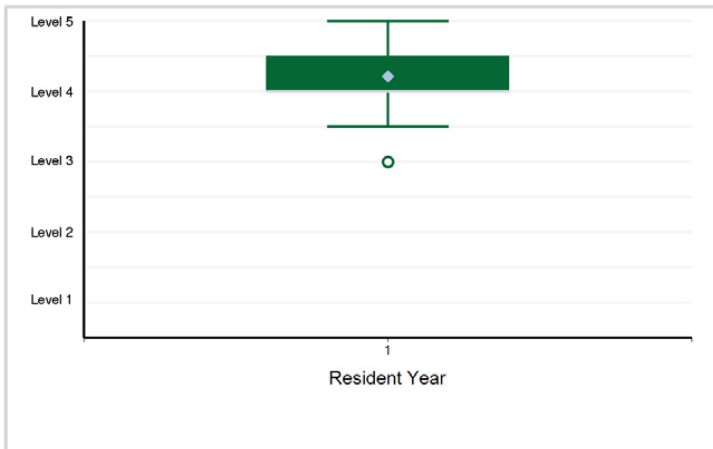

20. Practice-Based Learning and Improvement - Practice-Based Learning and Improvement 2: Reflective Practice and Commitment ...

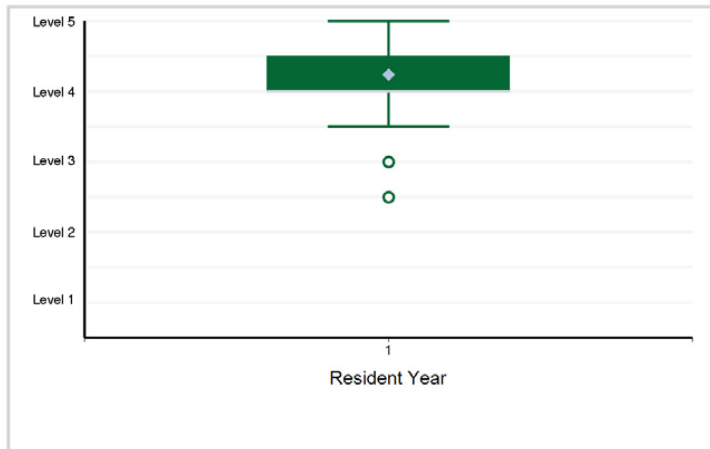

21. Professionalism - Professionalism 1: Ethical Principles

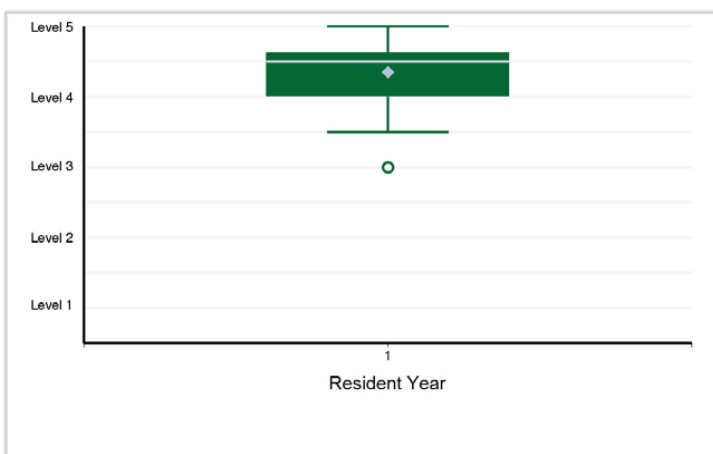

22. Professionalism - Professionalism 2: Professional Behavior and Accountability

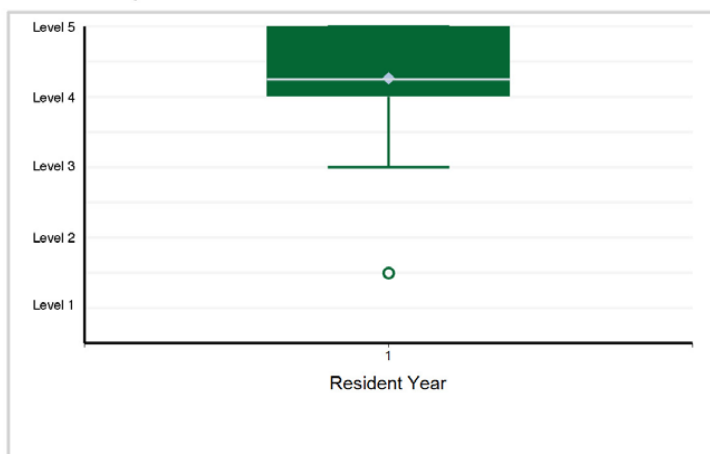

23. Professionalism - Professionalism 3: Administrative Tasks

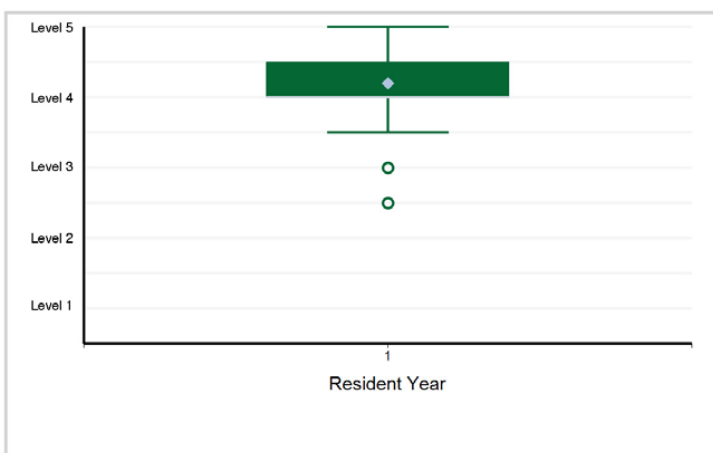

24. Professionalism - Professionalism 4: Self-Awareness and Help-Seeking

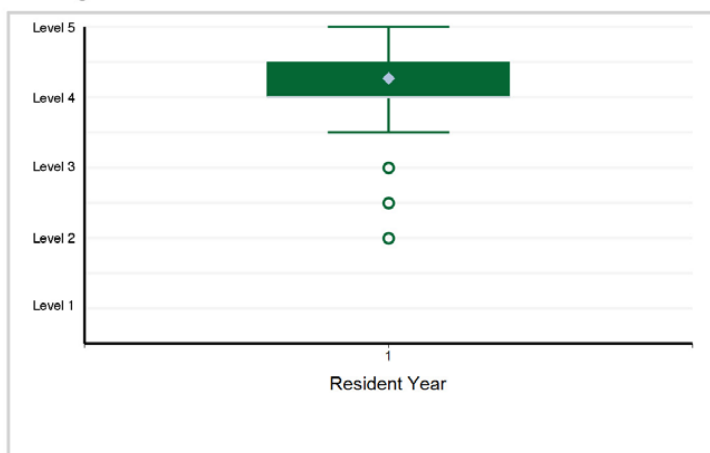

Specialty Box Plot Report - Milestone Evaluation by Resident Year: Year-End 2021-2022

SPECIALTY: Colon and Rectal Surgery

25. Interpersonal and Communication Skills - Interpersonal and Communication Skills 1: Patient- and Family-Centered Communication

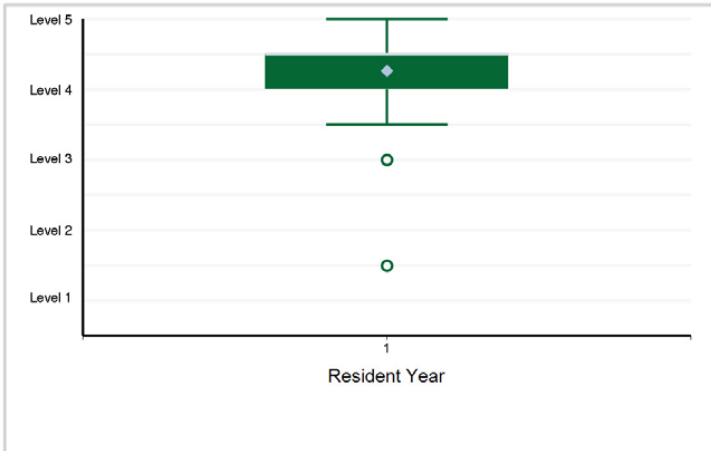

26. Interpersonal and Communication Skills - Interpersonal and Communication Skills 2: Interprofessional and Team Communication

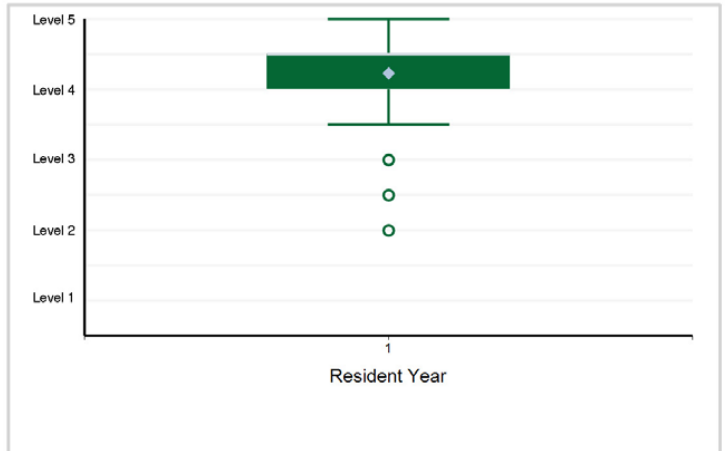

27. Interpersonal and Communication Skills - Interpersonal and Communication Skills 3: Communication within Health Care Systems

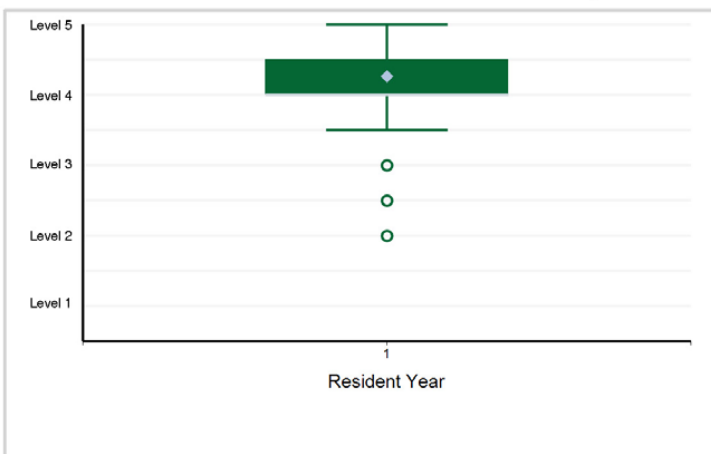

Specialty Box Plot Report - Milestone Evaluation by Resident Year: Year-End 2021-2022

TABLE 14: SPECIALTY: **Dermatology**

Resident Year	1	2	3	Total Residents*
# of Residents	520	511	509	1,540

*Note: There are 10 residents with an incomplete milestone evaluation that are excluded from the box plots below.

1. Patient Care - Patient Care 1: Medical Dermatology

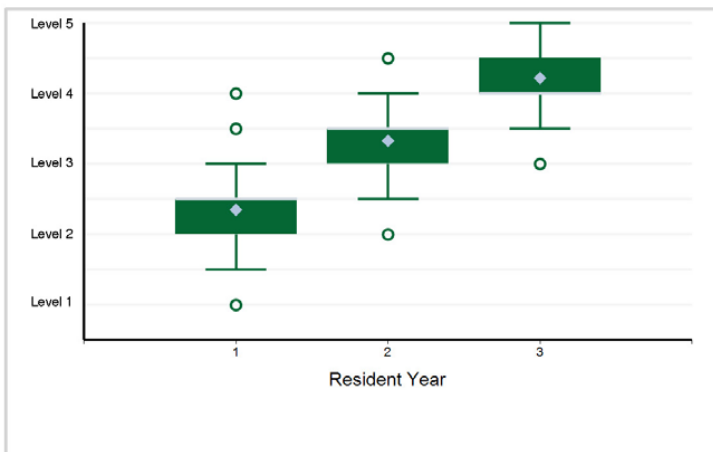

2. Patient Care - Patient Care 2: Pediatric Dermatology

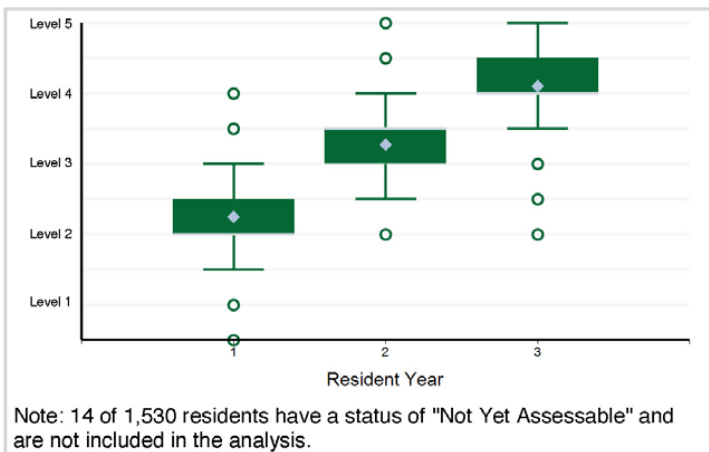

Note: 14 of 1,530 residents have a status of "Not Yet Assessable" and are not included in the analysis.

3. Patient Care - Patient Care 3: Dermatologic Procedures and Surgery

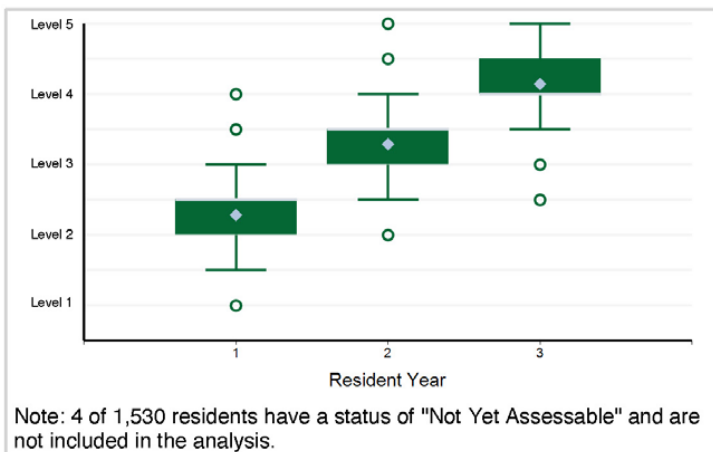

Note: 4 of 1,530 residents have a status of "Not Yet Assessable" and are not included in the analysis.

4. Patient Care - Patient Care 4: Dermatopathology

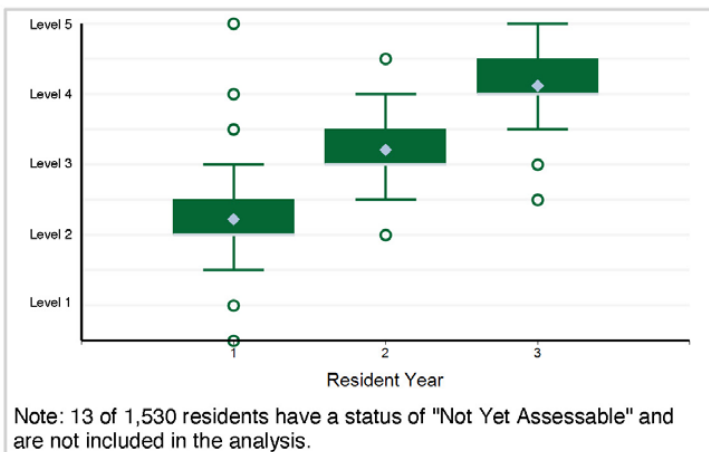

Note: 13 of 1,530 residents have a status of "Not Yet Assessable" and are not included in the analysis.

5. Patient Care - Patient Care 5: Cosmetic Care

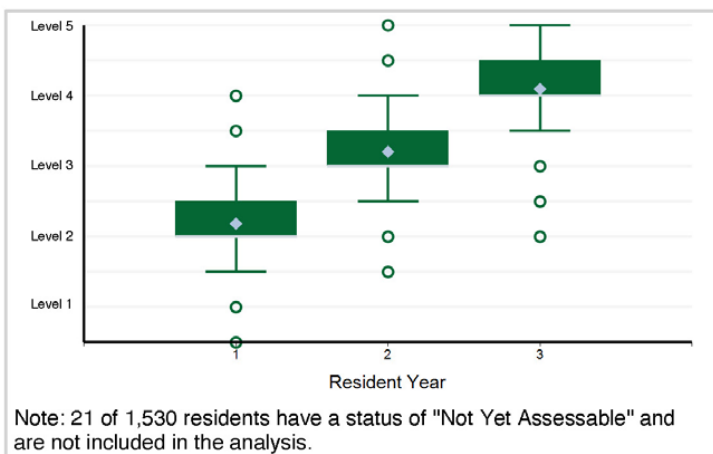

Note: 21 of 1,530 residents have a status of "Not Yet Assessable" and are not included in the analysis.

6. Patient Care - Patient Care 6: Diagnostics

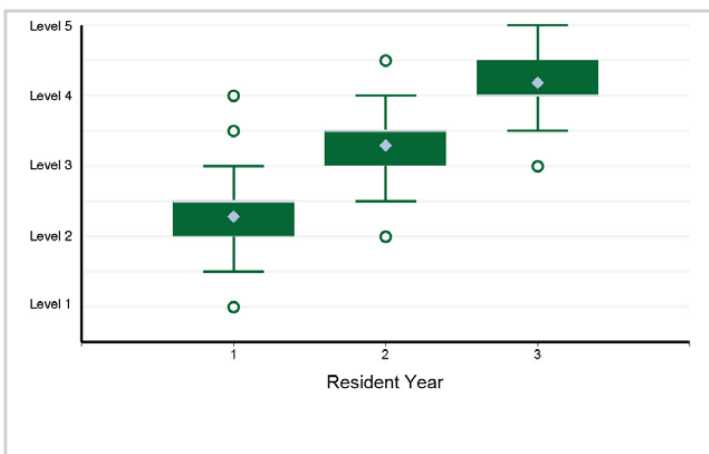

Specialty Box Plot Report - Milestone Evaluation by Resident Year: Year-End 2021-2022

SPECIALTY: **Dermatology**

7. Patient Care - Patient Care 7: Critical Thinking/Differential Diagnosis

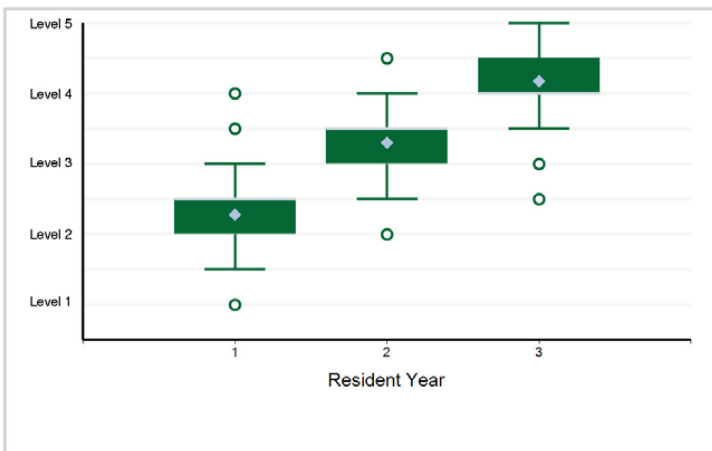

8. Patient Care - Patient Care 8: Therapeutics Management

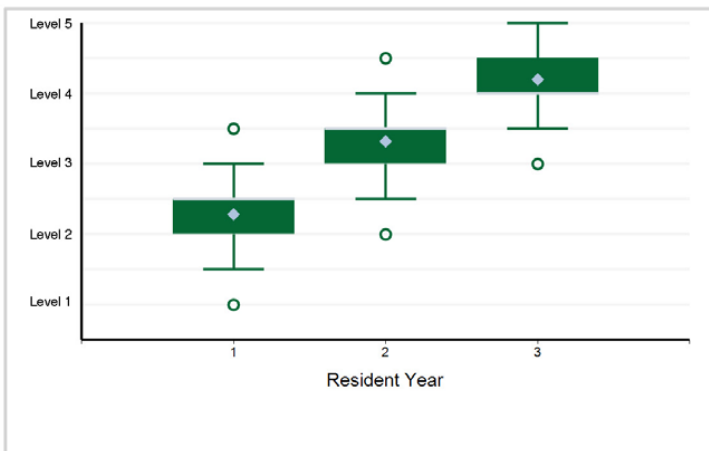

9. Medical Knowledge - Medical Knowledge 1: Knowledge of Dermatologic Disease

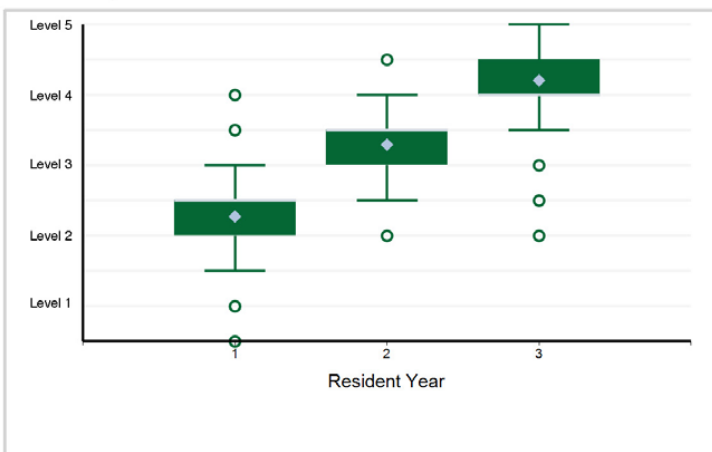

10. Medical Knowledge - Medical Knowledge 2: Visual Recognition

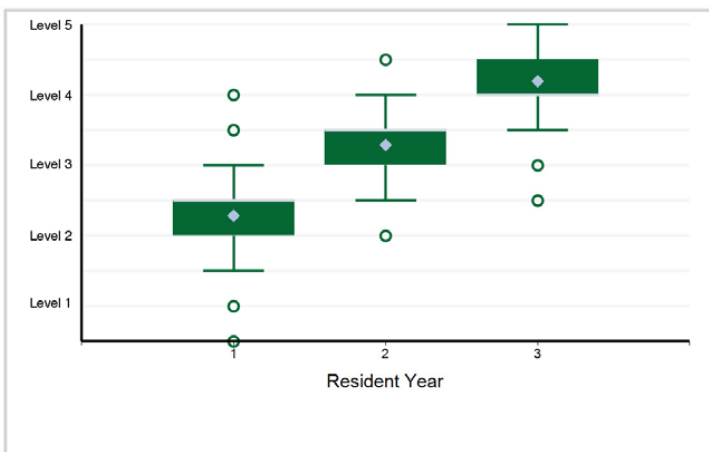

11. Systems-Based Practice - Systems-Based Practice 1: Patient Safety and Quality Improvement

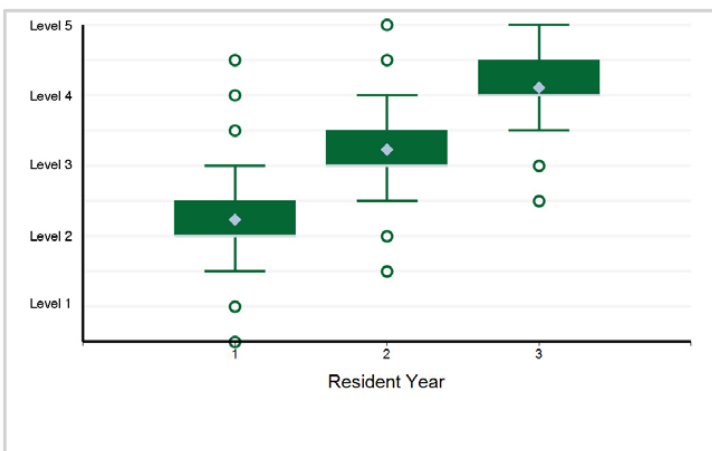

12. Systems-Based Practice - Systems-Based Practice 2: System Navigation for Patient-Centered Care

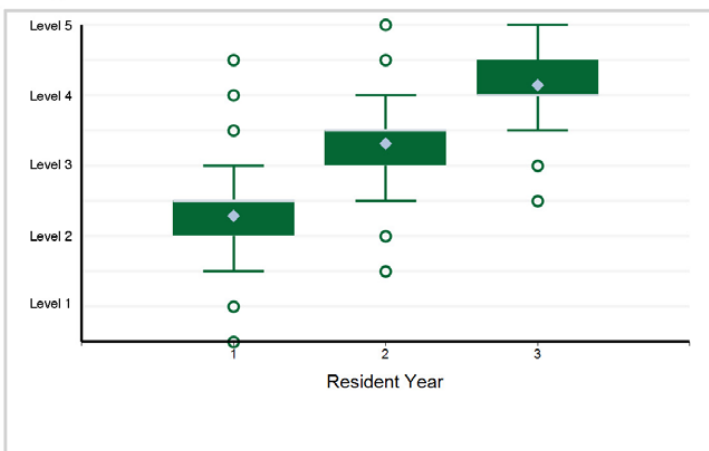

Specialty Box Plot Report - Milestone Evaluation by Resident Year: Year-End 2021-2022

SPECIALTY: **Dermatology**

13. Systems-Based Practice - Systems-Based Practice 3: Physician Role in Health Care Systems

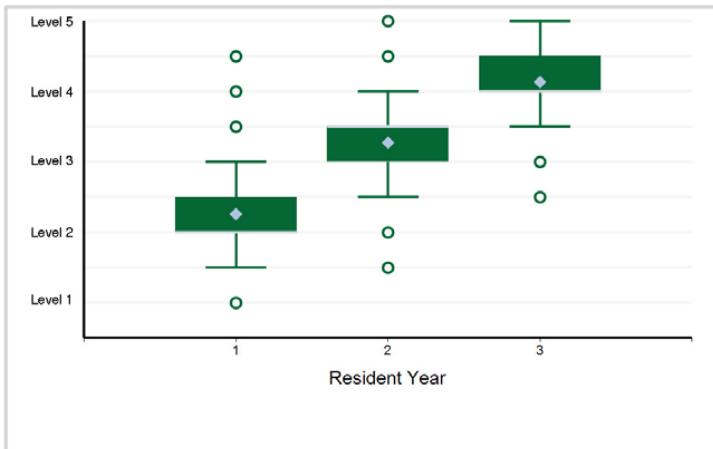

14. Practice-Based Learning and Improvement - Practice-Based Learning and Improvement 1: Evidence-Based and Informed Practice

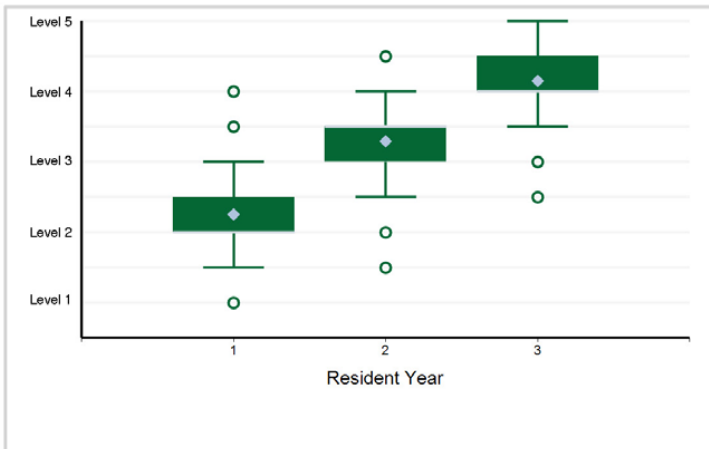

15. Practice-Based Learning and Improvement - Practice-Based Learning and Improvement 2: Reflective Practice and Commitment ...

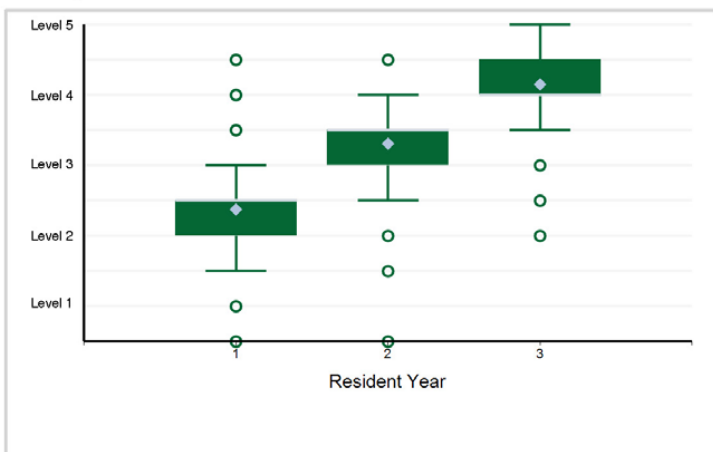

16. Professionalism - Professionalism 1: Professional Behavior and Ethical Principles

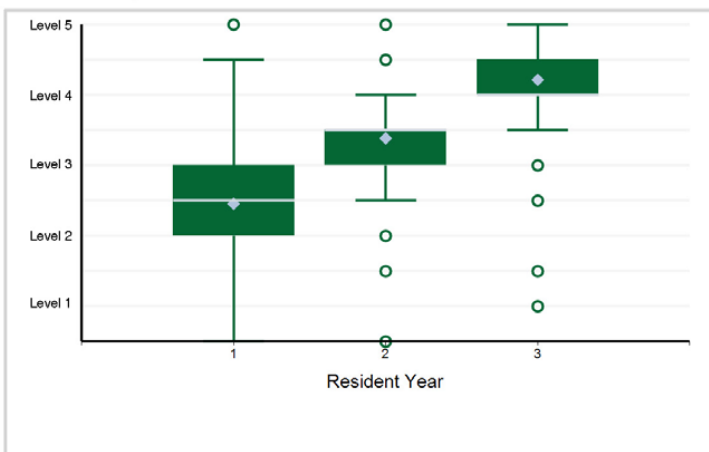

17. Professionalism - Professionalism 2: Accountability/Conscientiousness

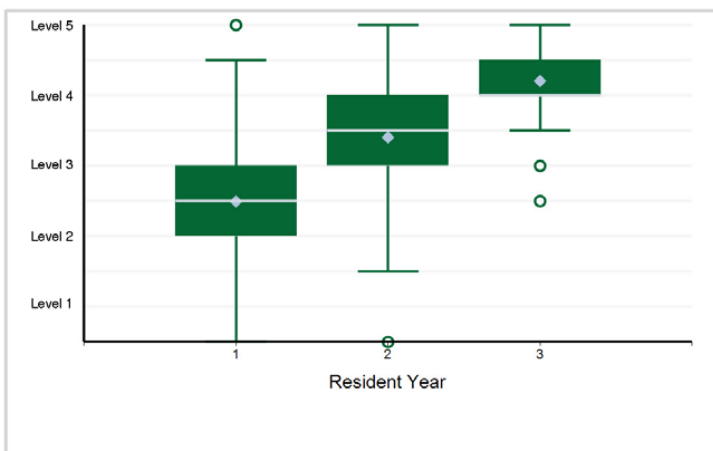

18. Professionalism - Professionalism 3: Self-Awareness and Help-Seeking

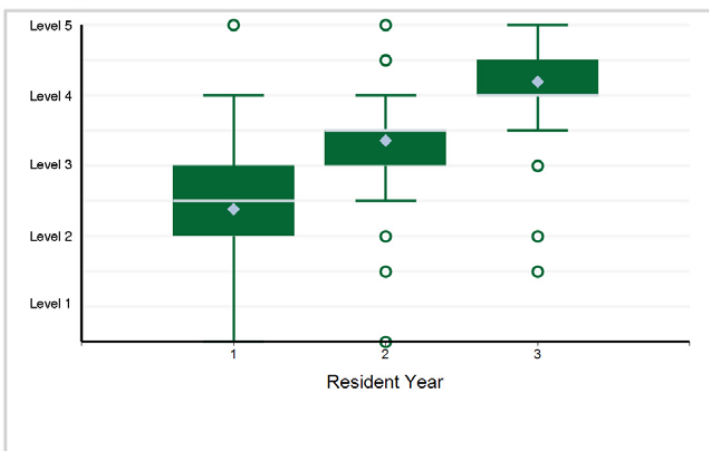

Specialty Box Plot Report - Milestone Evaluation by Resident Year: Year-End 2021-2022

SPECIALTY: **Dermatology**

19. Interpersonal and Communication Skills - Interpersonal and Communication Skills 1: Patient- and Family-Centered Communication

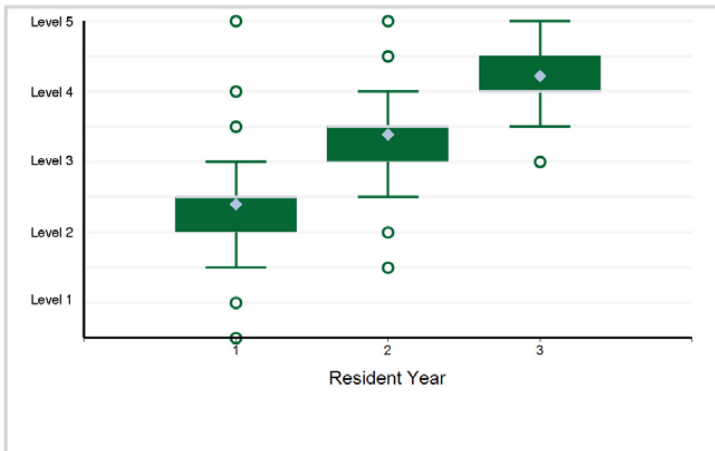

20. Interpersonal and Communication Skills - Interpersonal and Communication Skills 2: Interprofessional and Team Communication

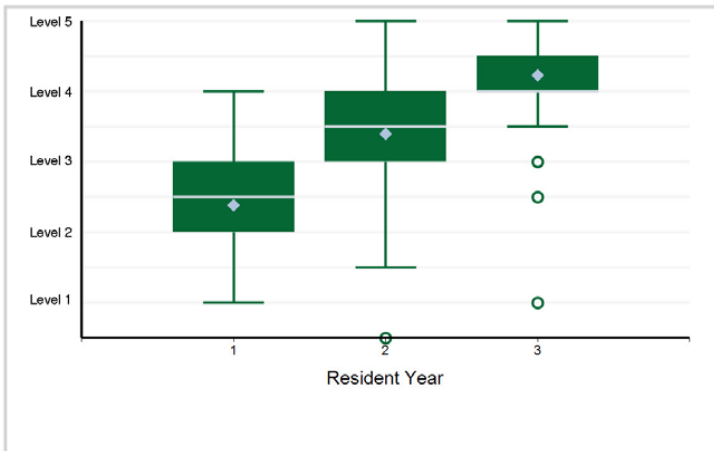

21. Interpersonal and Communication Skills - Interpersonal and Communication Skills 3: Communication within Health Care Systems

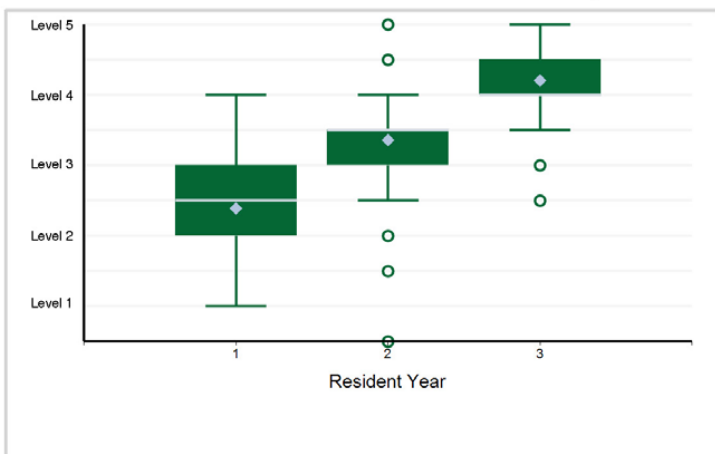

Specialty Box Plot Report - Milestone Evaluation by Resident Year: Year-End 2021-2022

TABLE 15: SUBSPECIALTY: **Dermatopathology (multidisciplinary, Dermatology)**

Resident Year	1	Total Residents
# of Residents	71	71

1. Patient Care - Dermatopathologic Diagnosis – PC1

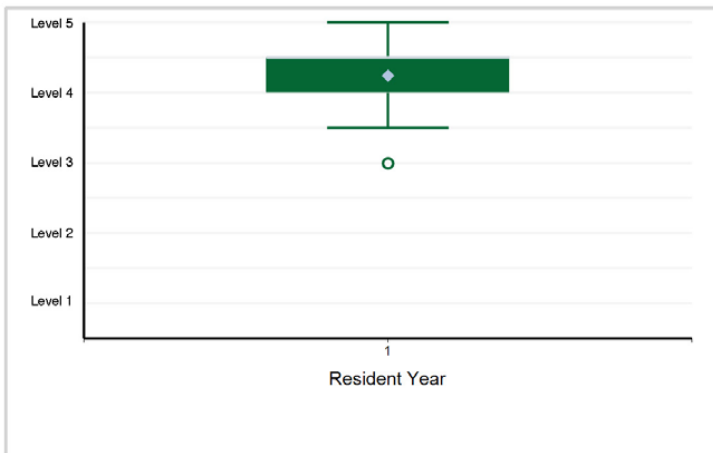

2. Patient Care - Ancillary Testing – PC2

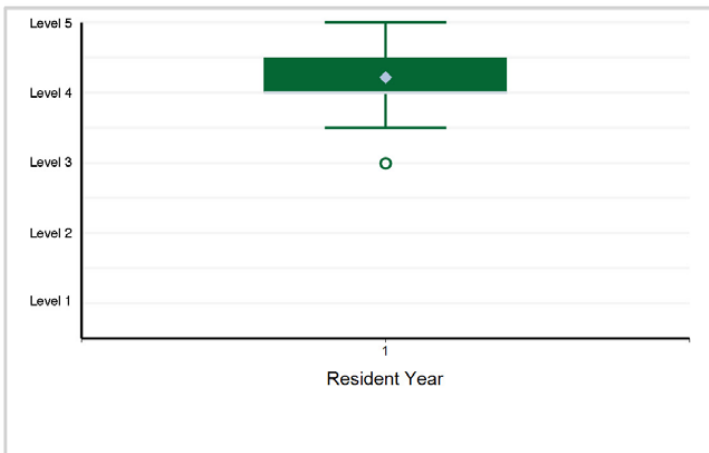

3. Medical Knowledge - Histopathologic Patterns – MK1

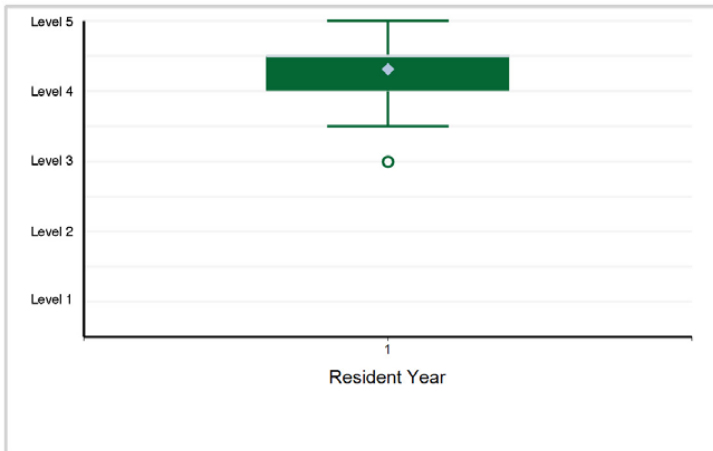

4. Medical Knowledge - Immunohistochemistry – MK2

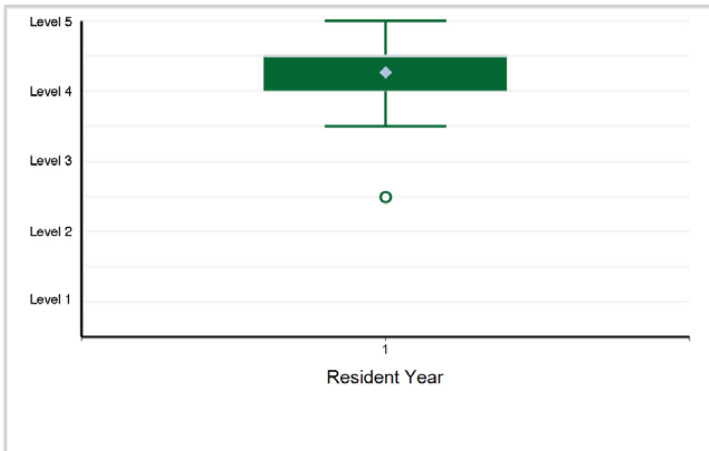

5. Systems-Based Practice - Health Care teams — SBP1

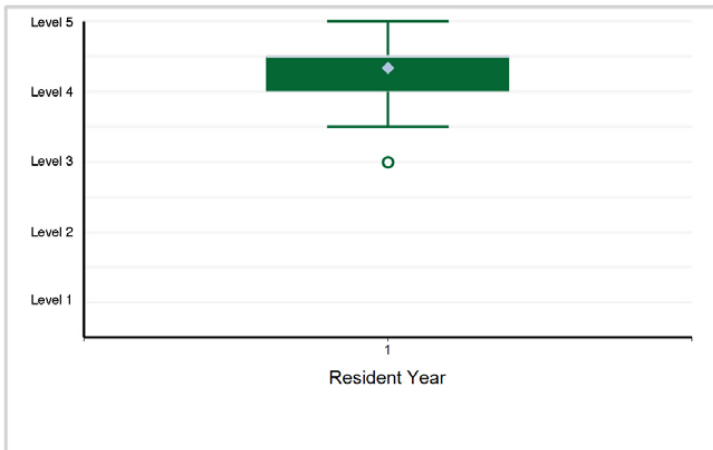

6. Systems-Based Practice - Patient Safety — SBP2

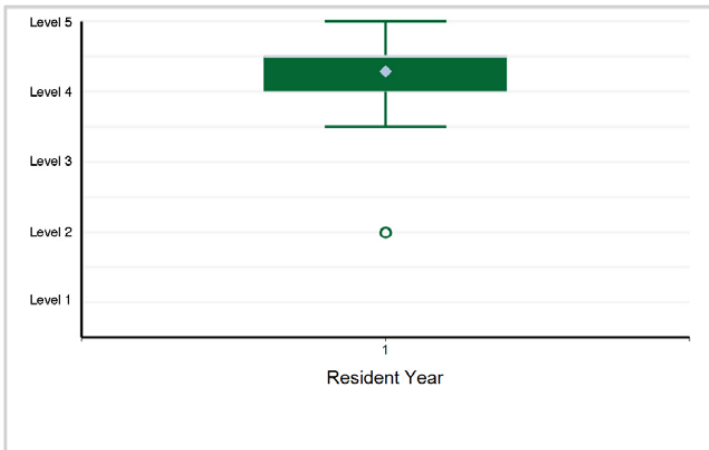

Specialty Box Plot Report - Milestone Evaluation by Resident Year: Year-End 2021-2022

SUBSPECIALTY: Dermatopathology (multidisciplinary, Dermatology)

7. Practice-Based Learning and Improvement - Evidence-based Practice — PBL1

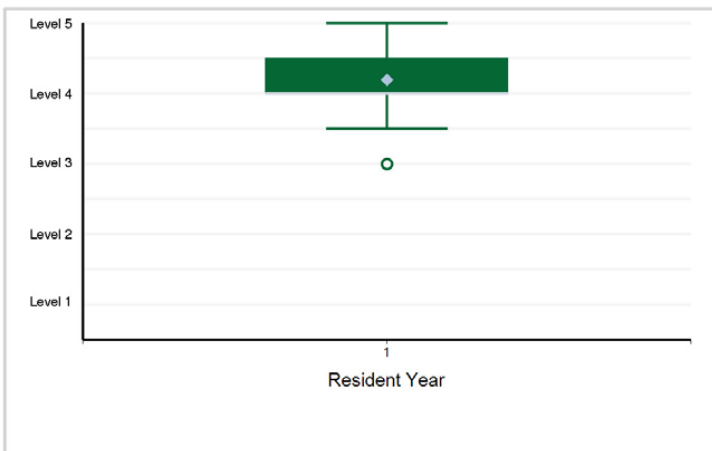

8. Practice-Based Learning and Improvement - Process Improvement and Patient Safety — PBL2



9. Professionalism - Accountability, Honesty, and Integrity — PROF1

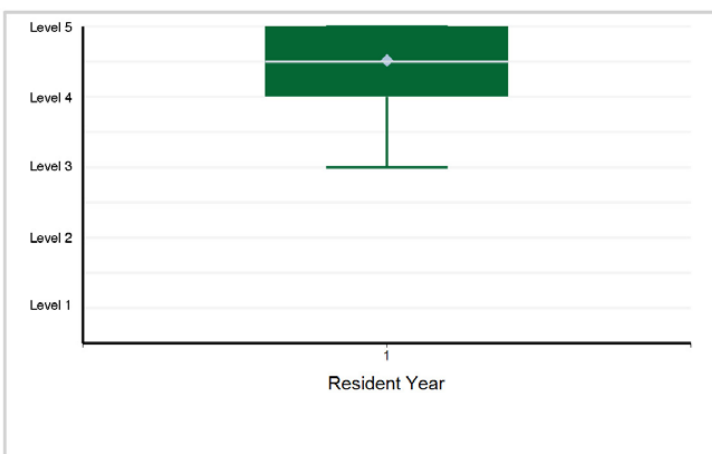

10. Professionalism - Giving and Receiving Feedback — PROF2

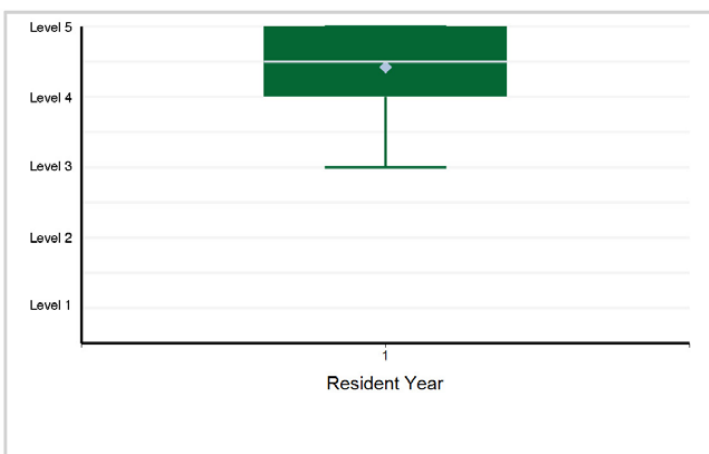

11. Interpersonal and Communication Skills - Personnel Management and Conflict Management — ICS1

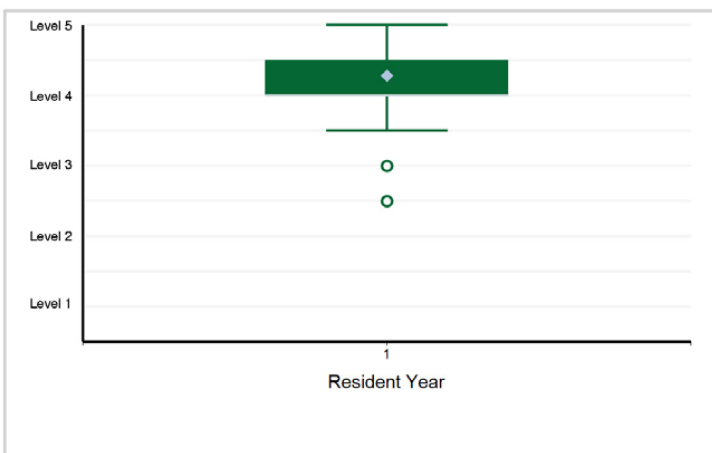

12. Interpersonal and Communication Skills - Diagnostic Reporting — ICS2

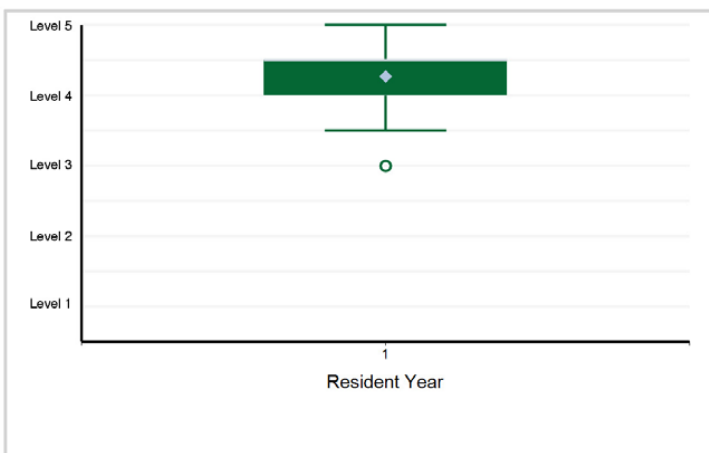

Specialty Box Plot Report - Milestone Evaluation by Resident Year: Year-End 2021-2022

TABLE 16: SUBSPECIALTY: **Micrographic Surgery and Dermatologic Oncology**

Resident Year	1	Total Residents
# of Residents	89	89

1. Patient Care - Patient Care 1 — Mohs Surgery

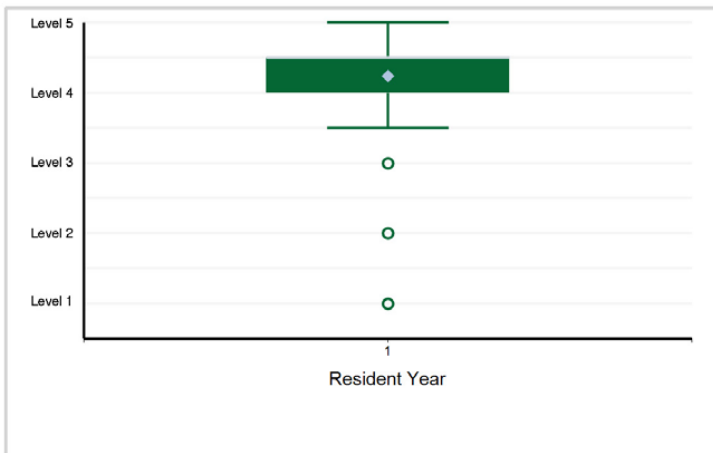

2. Patient Care - Patient Care 2 — Reconstruction

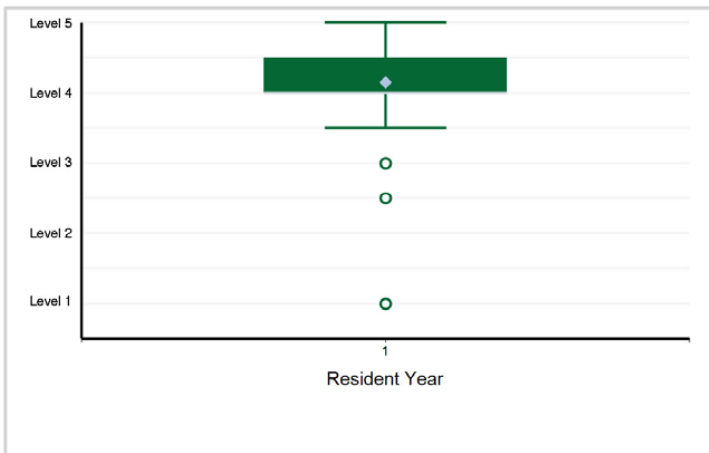

3. Patient Care - Patient Care 3 — Mohs Histopathology

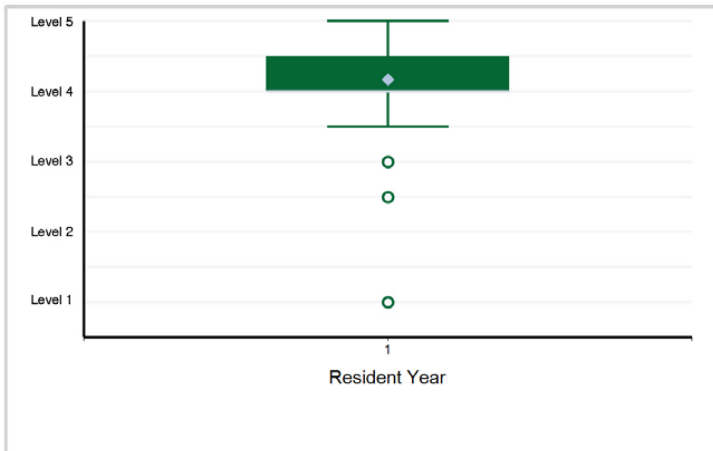

4. Patient Care - Patient Care 4 — Diagnosis and Management

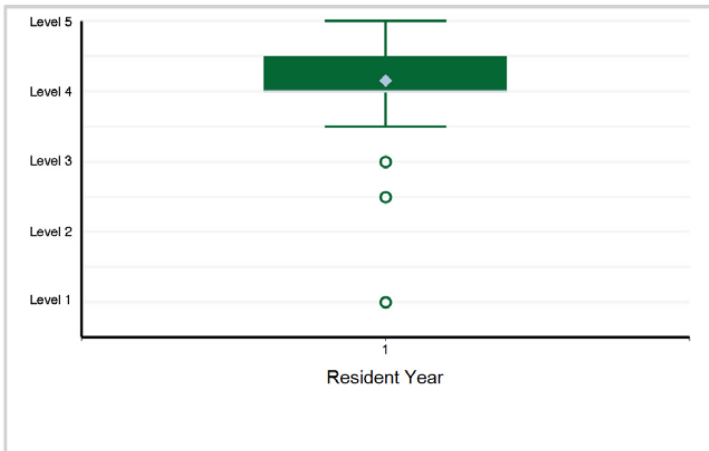

5. Medical Knowledge - Medical Knowledge 1 — Mastery of Dermatologic Surgical Curriculum

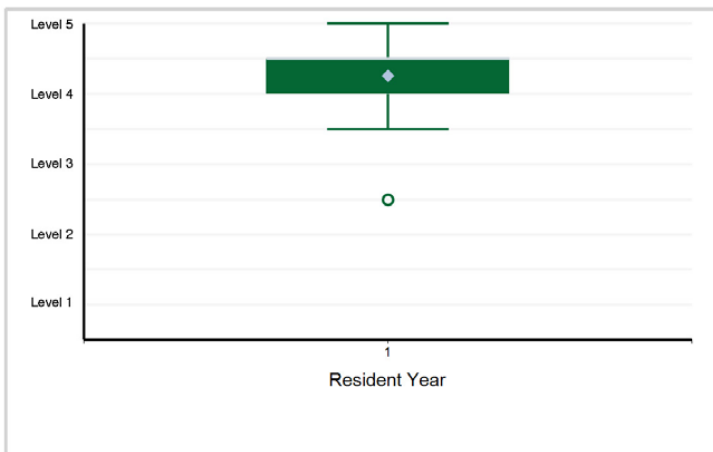

6. Medical Knowledge - Medical Knowledge 2 — Mastery of Cutaneous Oncologic Curriculum

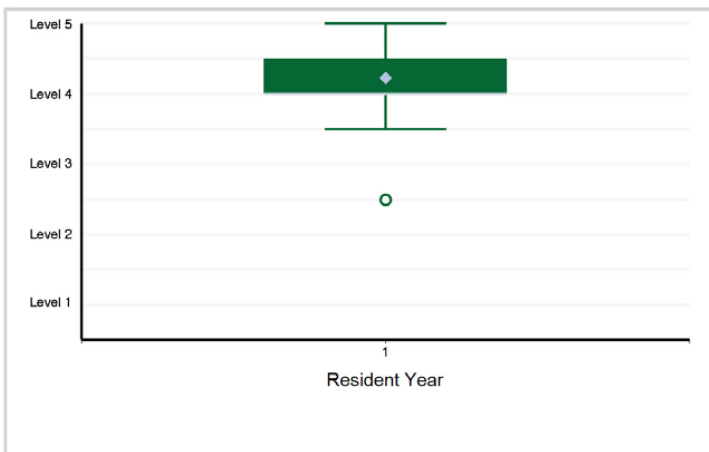

Specialty Box Plot Report - Milestone Evaluation by Resident Year: Year-End 2021-2022

SUBSPECIALTY: Micrographic Surgery and Dermatologic Oncology

7. Systems-Based Practice - Systems-Based Practice 1 — Practices Cost-Conscious Care (for Patients and Populations)

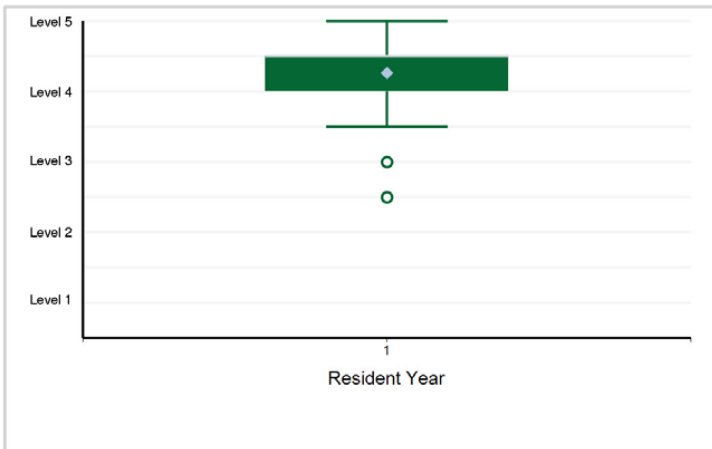

8. Systems-Based Practice - Systems-Based Practice 2 — Works Effectively within an Interprofessional Team

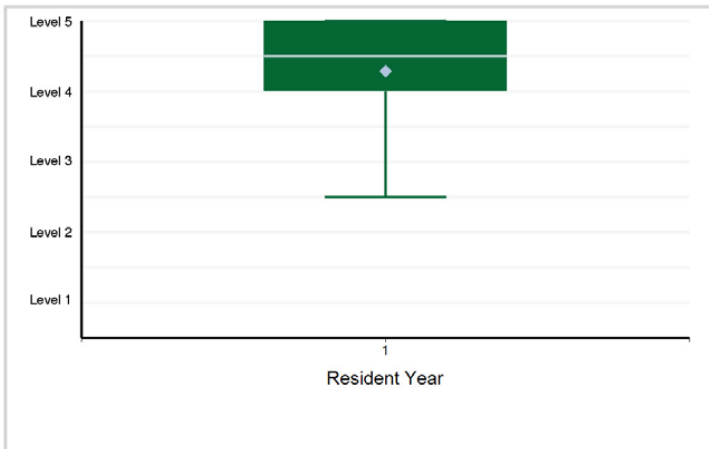

9. Practice-Based Learning and Improvement - Practice-Based Learning and Improvement 1 — Appraises and ...

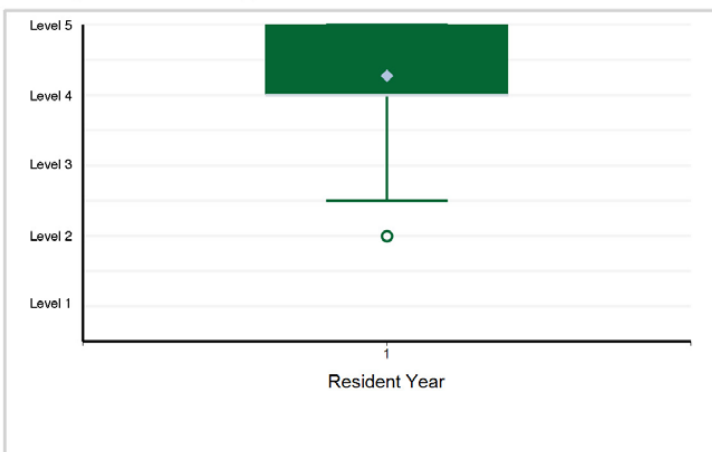

10. Practice-Based Learning and Improvement - Practice-Based Learning and Improvement 2 — Integrates Quality ...

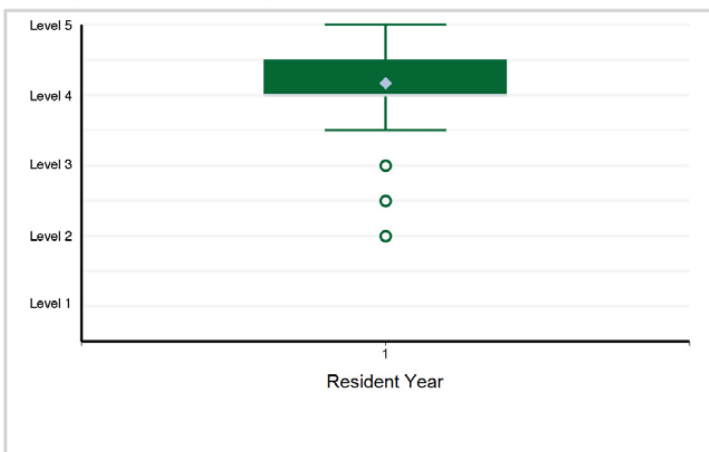

11. Professionalism - Professionalism 1 — Giving and Receiving Feedback

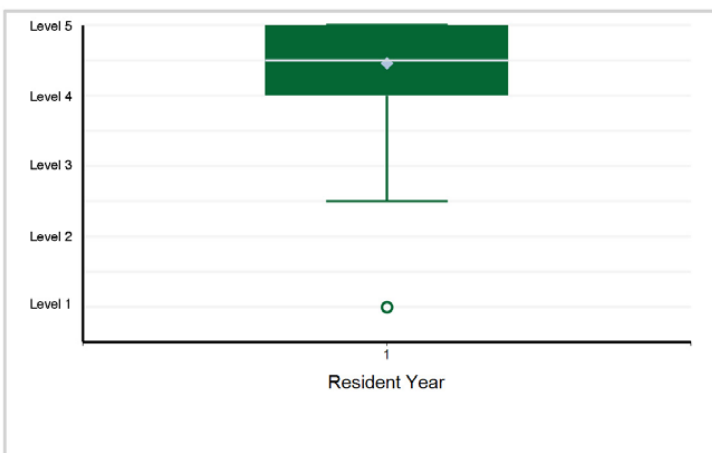

12. Professionalism - Professionalism 2 — Accountability, Honesty, and Integrity

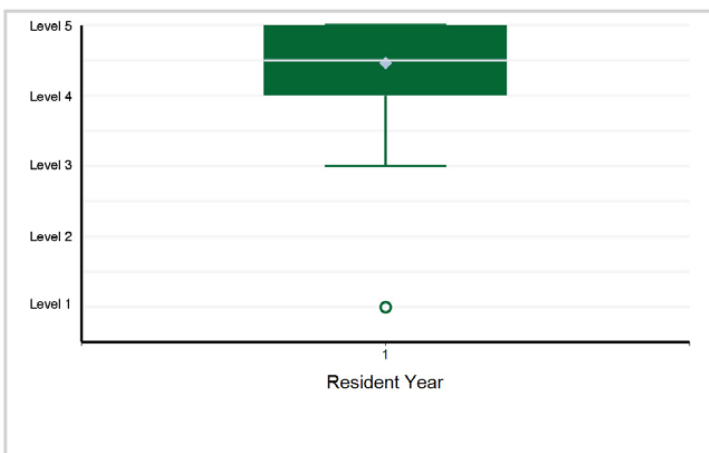

Specialty Box Plot Report - Milestone Evaluation by Resident Year: Year-End 2021-2022

SUBSPECIALTY: Micrographic Surgery and Dermatologic Oncology

13. Interpersonal and Communication Skills - Interpersonal Communication and Skills 1 — Personnel and Conflict Management

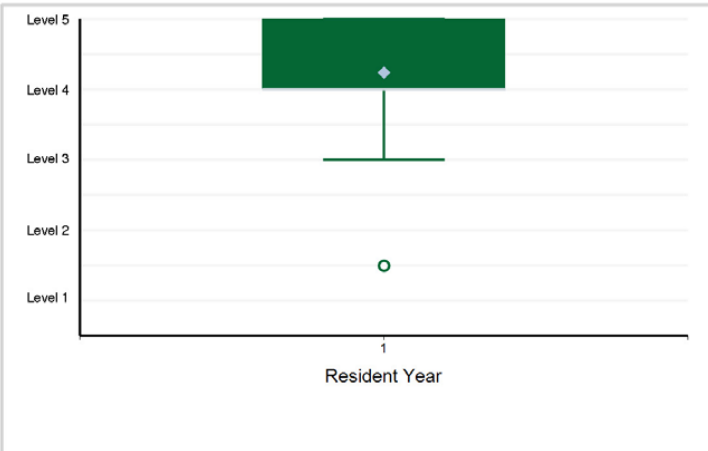

14. Interpersonal and Communication Skills - Interpersonal and Communication Skills 2 — Communicates with ...

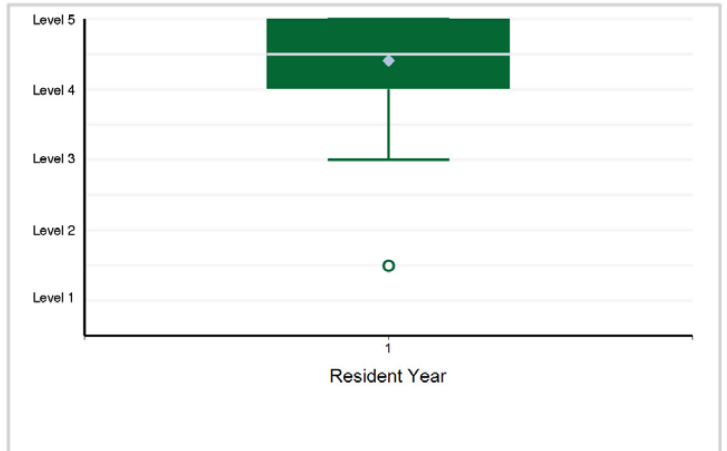

Specialty Box Plot Report - Milestone Evaluation by Resident Year: Year-End 2021-2022

TABLE 17: SPECIALTY: **Emergency Medicine (Three-Year Program)**

Resident Year	1	2	3	Total Residents
# of Residents	2,268	2,135	1,989	6,392

1. Patient Care - Patient Care 1: Emergency Stabilization

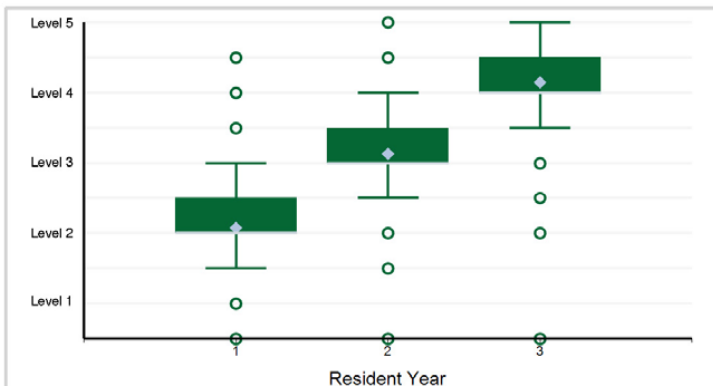

Note: 2 of 6,392 residents have a status of "Not Yet Assessable" and are not included in the analysis.

2. Patient Care - Patient Care 2: Performance of a Focused History and Physical Exam

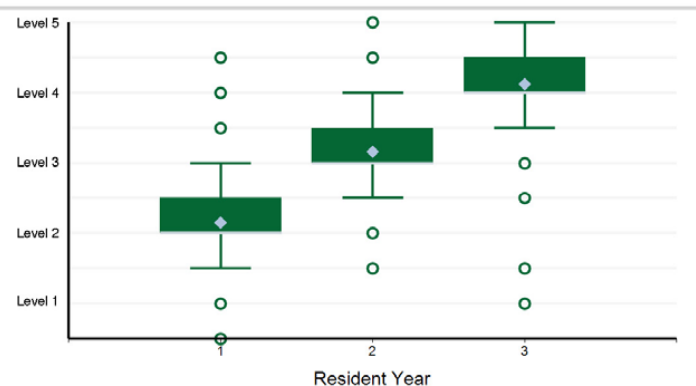

Note: 2 of 6,392 residents have a status of "Not Yet Assessable" and are not included in the analysis.

3. Patient Care - Patient Care 3: Diagnostic Studies

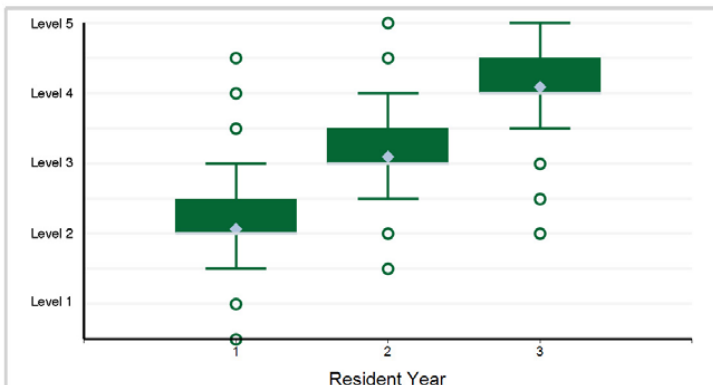

Note: 2 of 6,392 residents have a status of "Not Yet Assessable" and are not included in the analysis.

4. Patient Care - Patient Care 4: Diagnosis

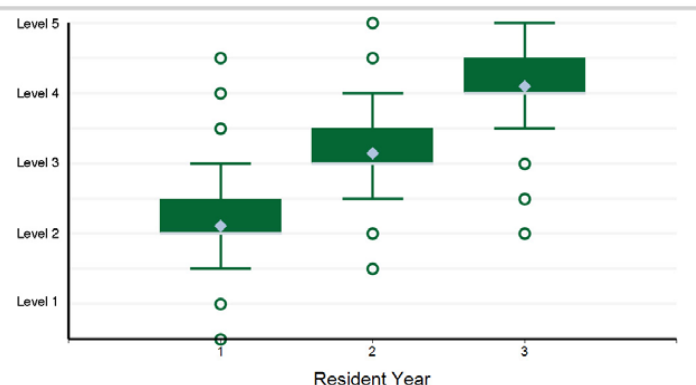

Note: 2 of 6,392 residents have a status of "Not Yet Assessable" and are not included in the analysis.

5. Patient Care - Patient Care 5: Pharmacotherapy

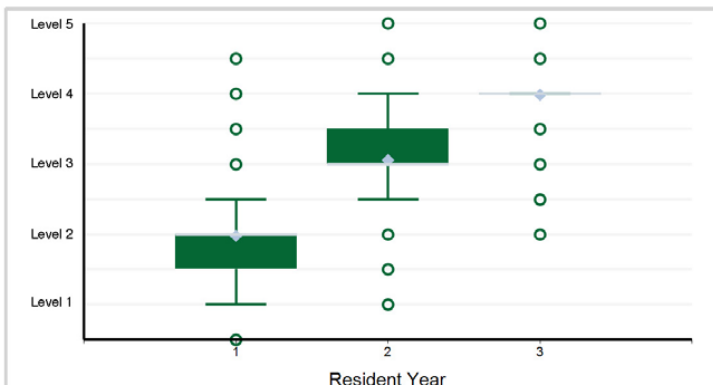

Note: 2 of 6,392 residents have a status of "Not Yet Assessable" and are not included in the analysis.

6. Patient Care - Patient Care 6: Reassessment and Disposition

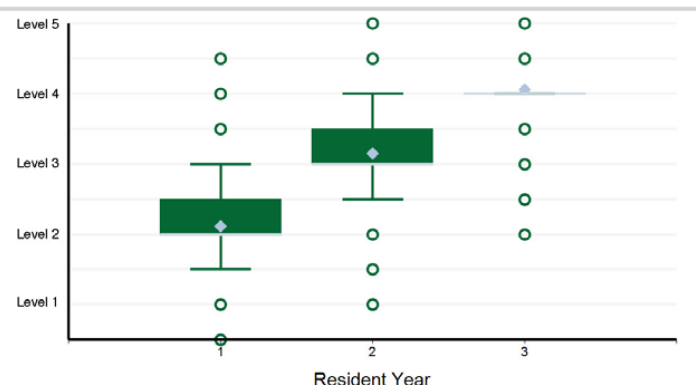

Note: 2 of 6,392 residents have a status of "Not Yet Assessable" and are not included in the analysis.

Specialty Box Plot Report - Milestone Evaluation by Resident Year: Year-End 2021-2022

SPECIALTY: Emergency Medicine (Three-Year Program)

7. Patient Care - Patient Care 7: Multitasking (Task-Switching)

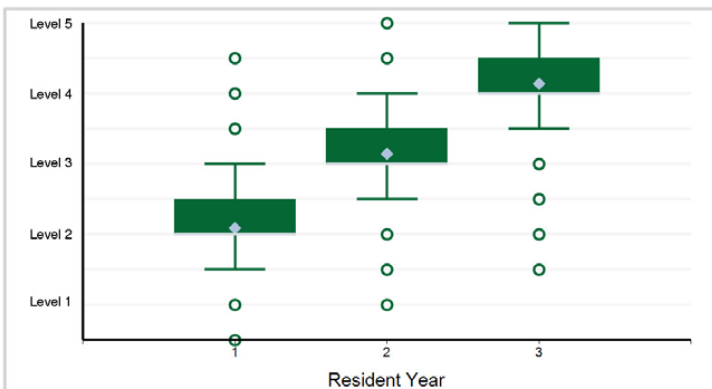

Note: 2 of 6,392 residents have a status of "Not Yet Assessable" and are not included in the analysis.

8. Patient Care - Patient Care 8: General Approach to Procedures

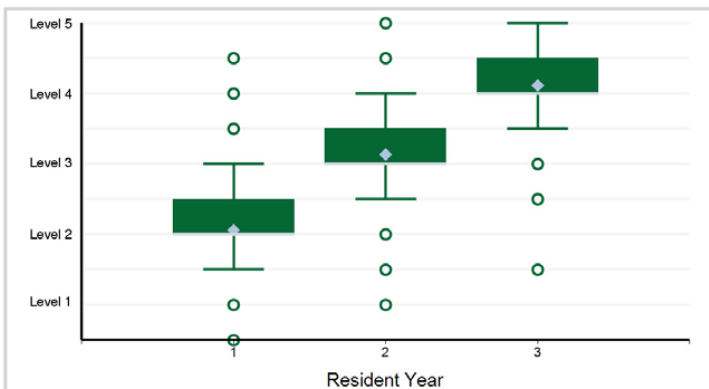

Note: 2 of 6,392 residents have a status of "Not Yet Assessable" and are not included in the analysis.

9. Medical Knowledge - Medical Knowledge 1: Scientific Knowledge

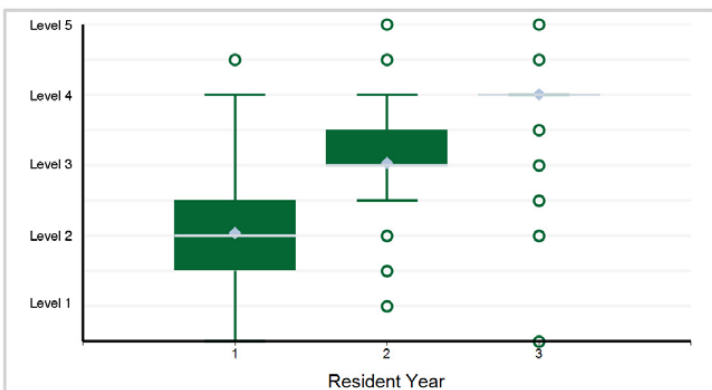

Note: 3 of 6,392 residents have a status of "Not Yet Assessable" and are not included in the analysis.

10. Medical Knowledge - Medical Knowledge 2: Treatment and Clinical Reasoning

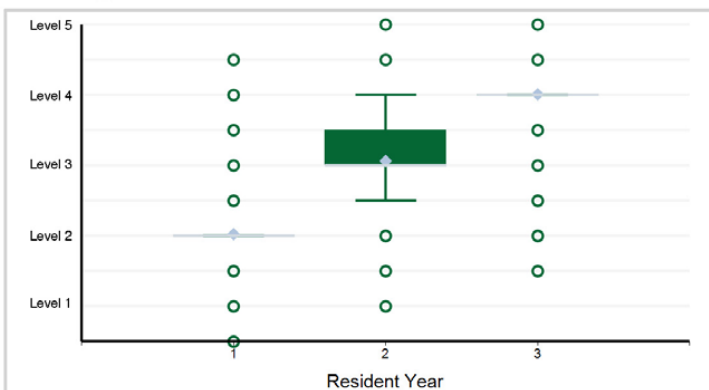

Note: 2 of 6,392 residents have a status of "Not Yet Assessable" and are not included in the analysis.

11. Systems-Based Practice - Systems-Based Practice 1: Patient Safety

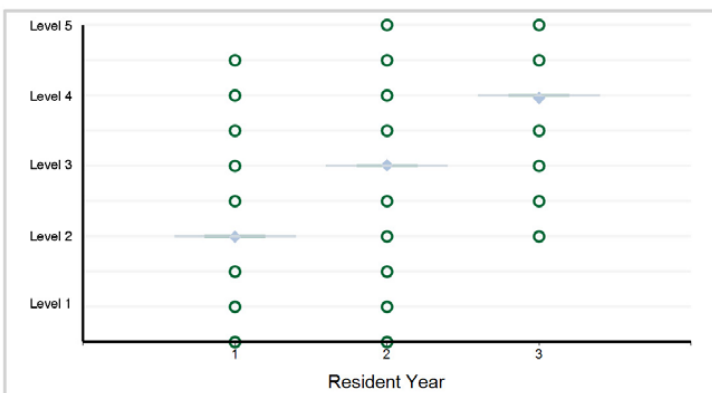

12. Systems-Based Practice - Systems-Based Practice 2: Quality Improvement

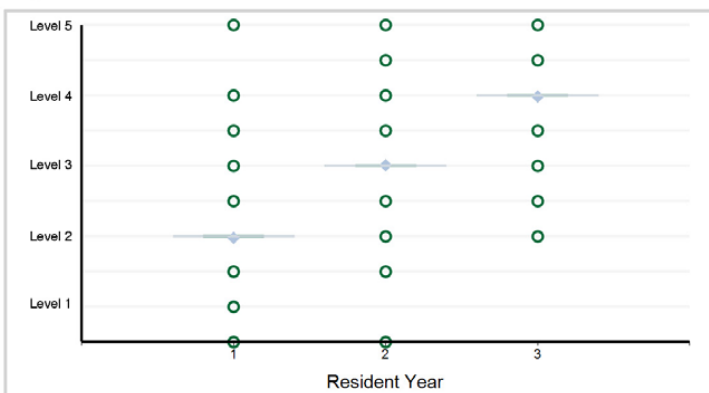

Specialty Box Plot Report - Milestone Evaluation by Resident Year: Year-End 2021-2022

SPECIALTY: Emergency Medicine (Three-Year Program)

13. Systems-Based Practice - Systems-Based Practice 3: System Navigation for Patient-Centered Care

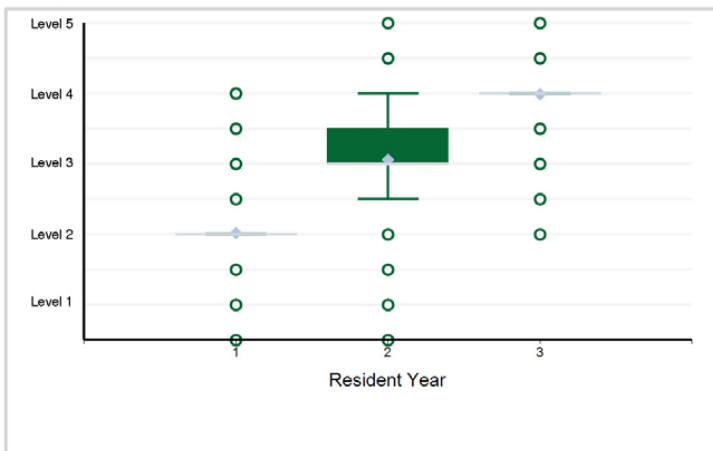

14. Systems-Based Practice - Systems-Based Practice 4: Physician Role in Health Care Systems

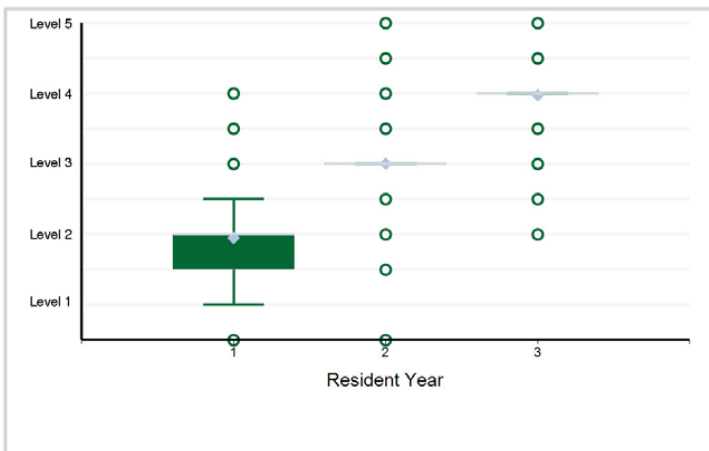

15. Practice-Based Learning and Improvement - Practice-Based Learning and Improvement 1: Evidence-Based and Informed Practice

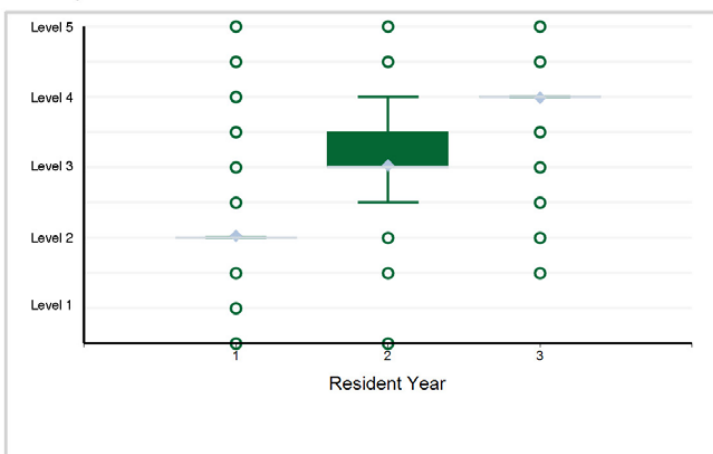

16. Practice-Based Learning and Improvement - Practice-Based Learning and Improvement 2: Reflective Practice and Commitment ...

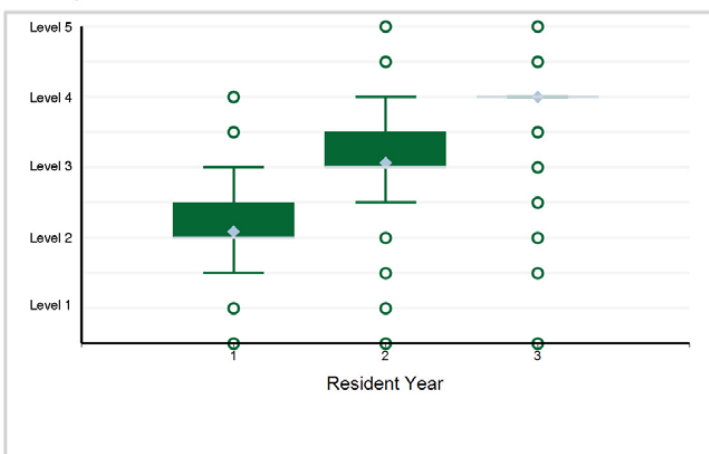

17. Professionalism - Professionalism 1: Professional Behavior and Ethical Principles

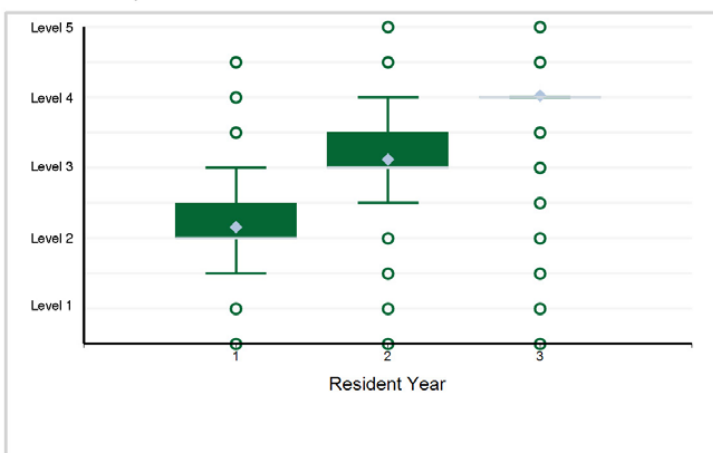

18. Professionalism - Professionalism 2: Accountability/Conscientiousness

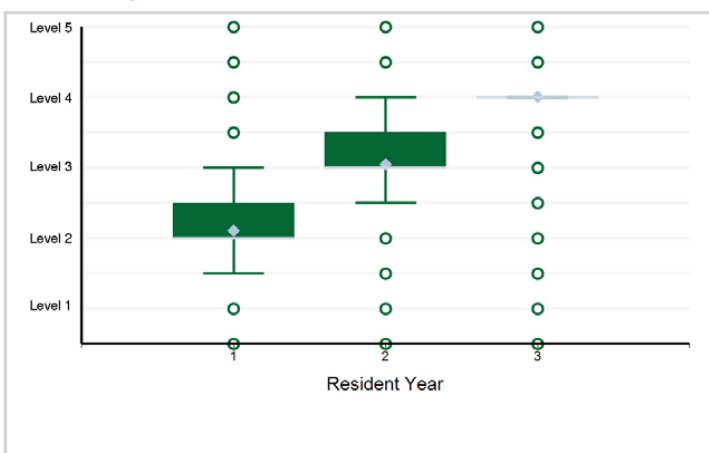

Specialty Box Plot Report - Milestone Evaluation by Resident Year: Year-End 2021-2022

SPECIALTY: Emergency Medicine (Three-Year Program)

19. Professionalism - Professionalism 3: Self-Awareness and Well-Being

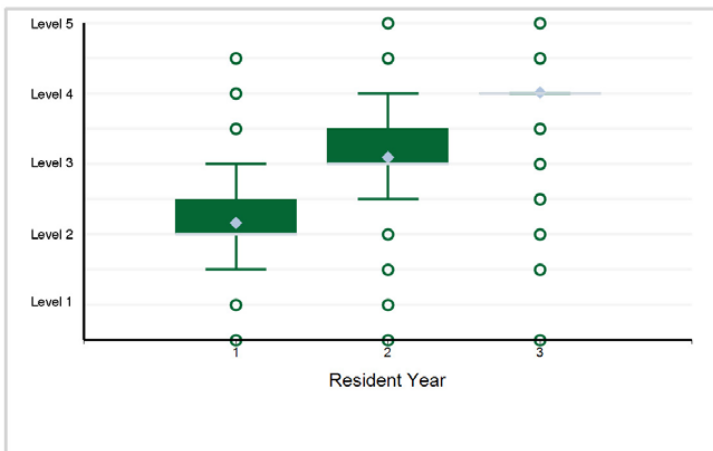

20. Interpersonal and Communication Skills - Interpersonal and Communication Skills 1: Patient- and Family-Centered Communication

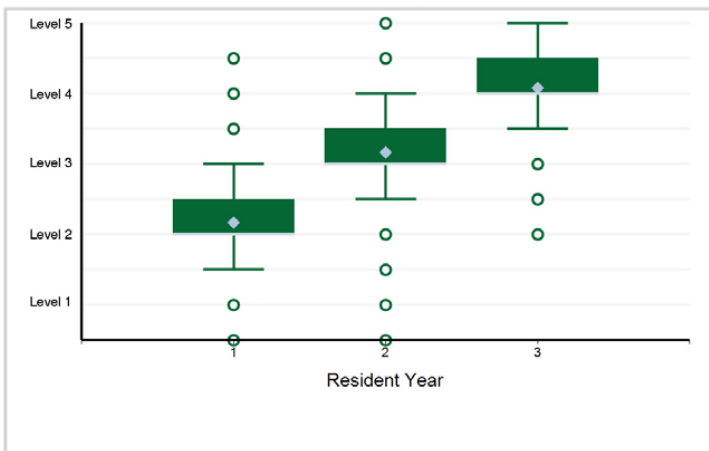

21. Interpersonal and Communication Skills - Interpersonal and Communication Skills 2: Interprofessional and Team Communication

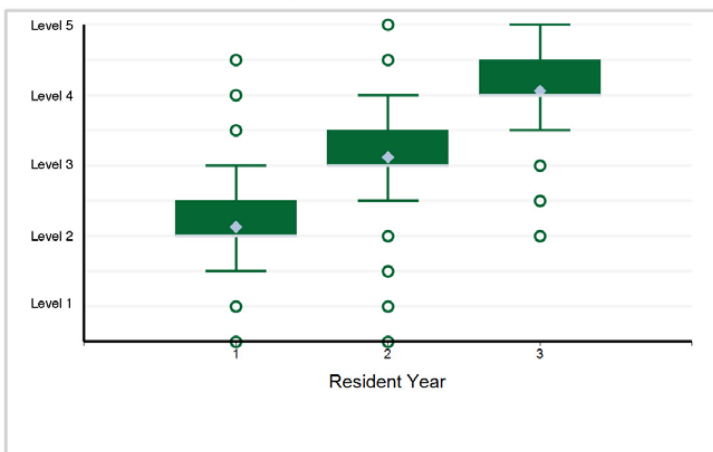

22. Interpersonal and Communication Skills - Interpersonal and Communication Skills 3: Communication within Health Care Systems

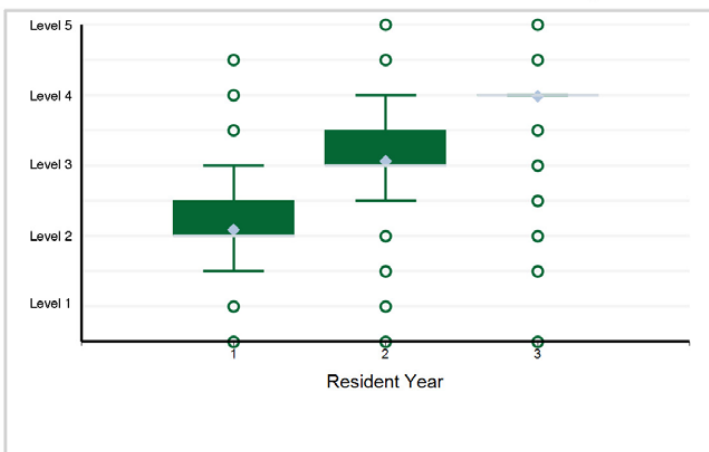

Specialty Box Plot Report - Milestone Evaluation by Resident Year: Year-End 2021-2022

SPECIALTY: Emergency Medicine (Four-Year Program)

Resident Year	1	2	3	4	Total Residents
# of Residents	680	666	667	648	2,661

1. Patient Care - Patient Care 1: Emergency Stabilization

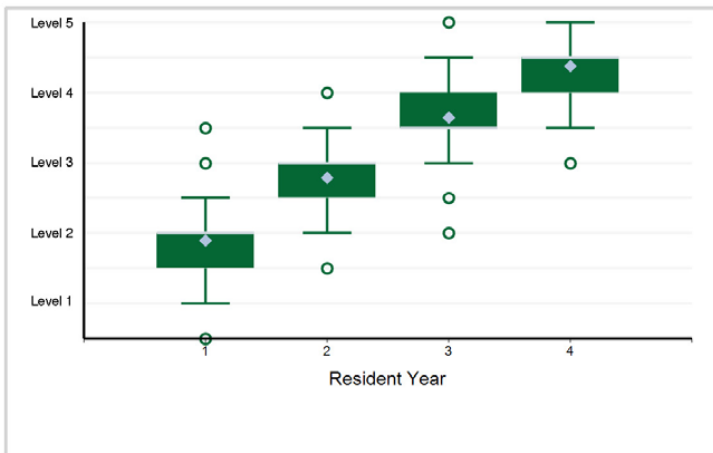

2. Patient Care - Patient Care 2: Performance of a Focused History and Physical Exam

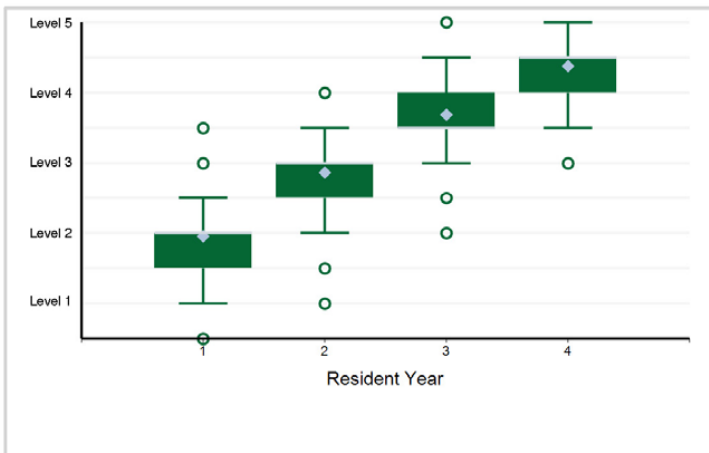

3. Patient Care - Patient Care 3: Diagnostic Studies

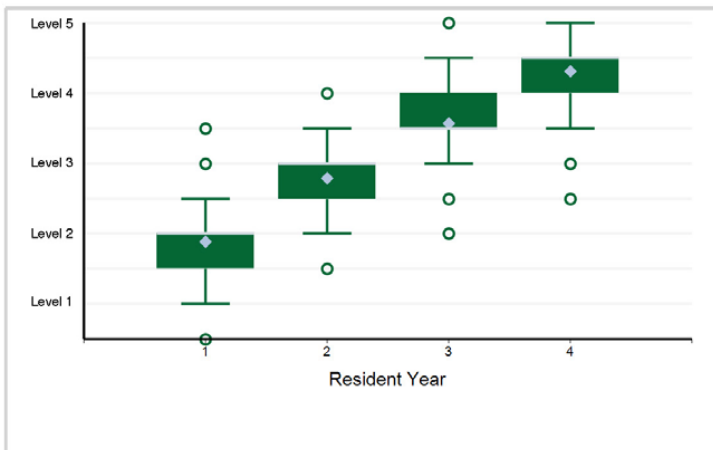

4. Patient Care - Patient Care 4: Diagnosis

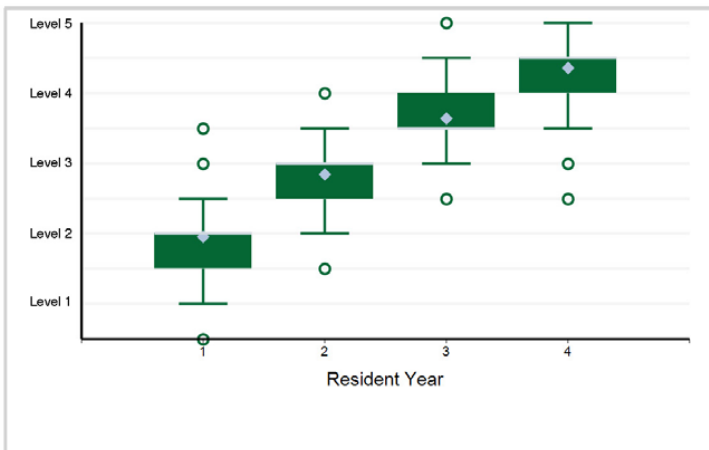

5. Patient Care - Patient Care 5: Pharmacotherapy

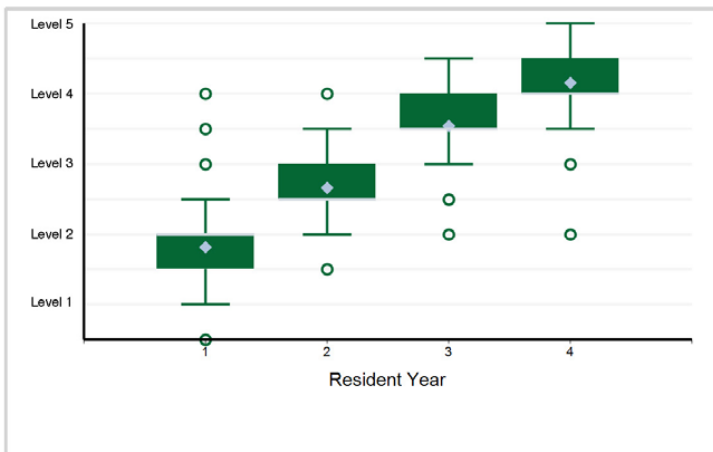

6. Patient Care - Patient Care 6: Reassessment and Disposition

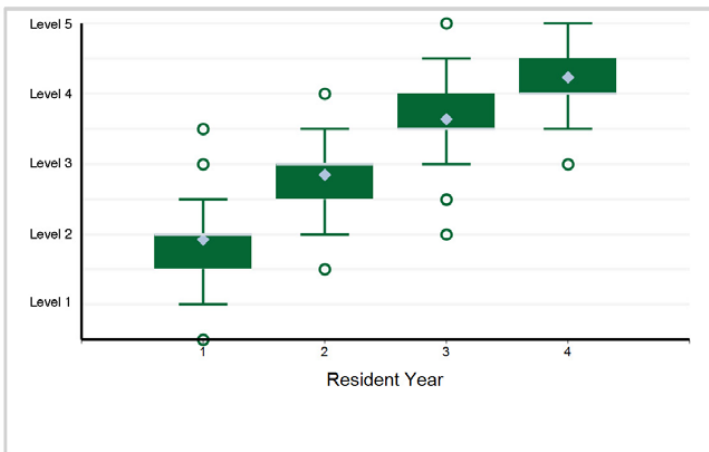

Specialty Box Plot Report - Milestone Evaluation by Resident Year: Year-End 2021-2022

SPECIALTY: Emergency Medicine (Four-Year Program)

7. Patient Care - Patient Care 7: Multitasking (Task-Switching)

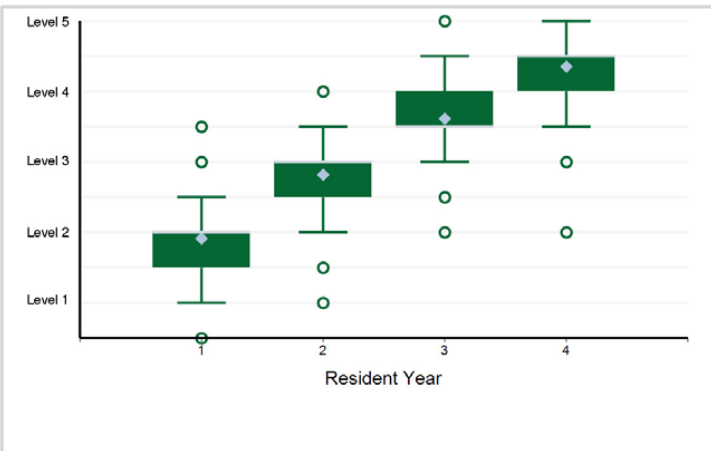

8. Patient Care - Patient Care 8: General Approach to Procedures

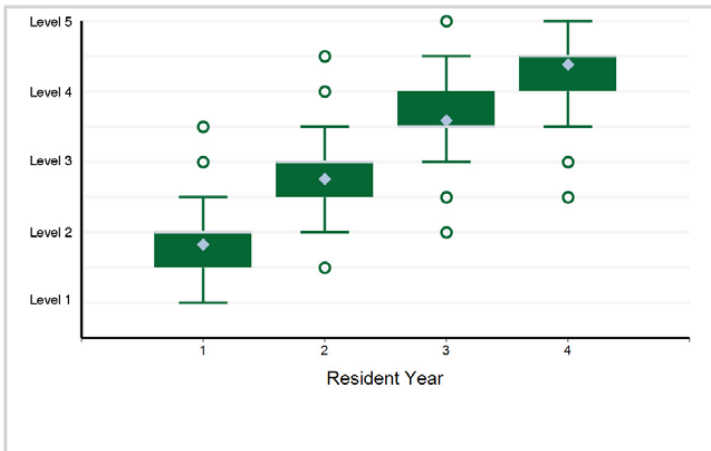

9. Medical Knowledge - Medical Knowledge 1: Scientific Knowledge

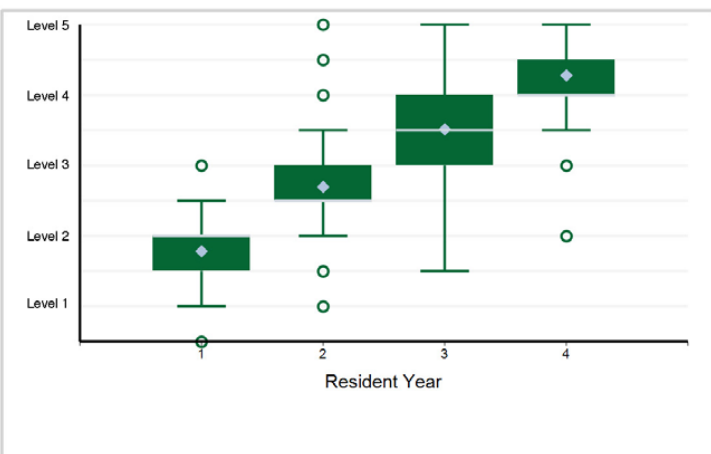

10. Medical Knowledge - Medical Knowledge 2: Treatment and Clinical Reasoning

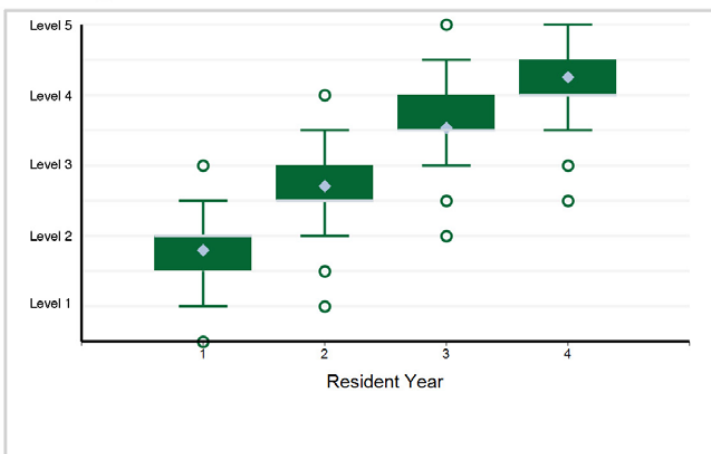

11. Systems-Based Practice - Systems-Based Practice 1: Patient Safety

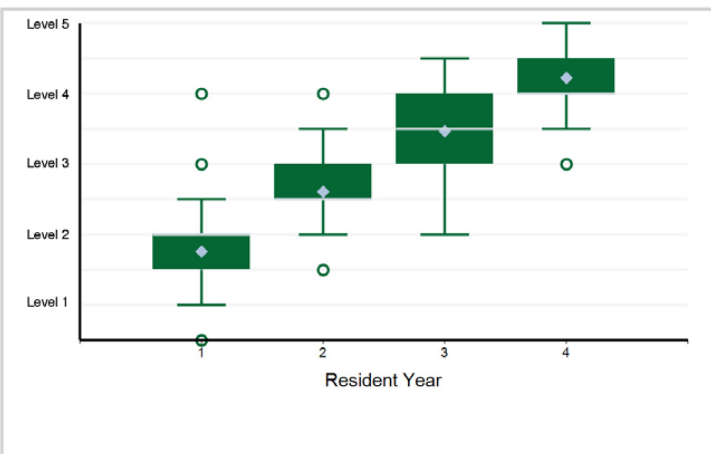

12. Systems-Based Practice - Systems-Based Practice 2: Quality Improvement

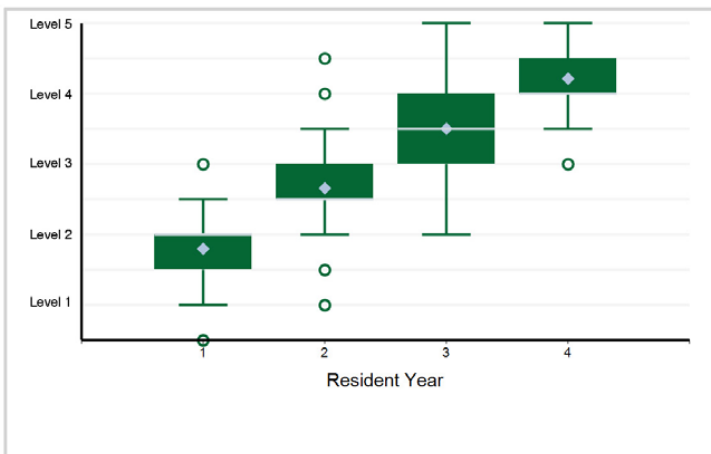

Specialty Box Plot Report - Milestone Evaluation by Resident Year: Year-End 2021-2022

SPECIALTY: Emergency Medicine (Four-Year Program)

13. Systems-Based Practice - Systems-Based Practice 3: System Navigation for Patient-Centered Care

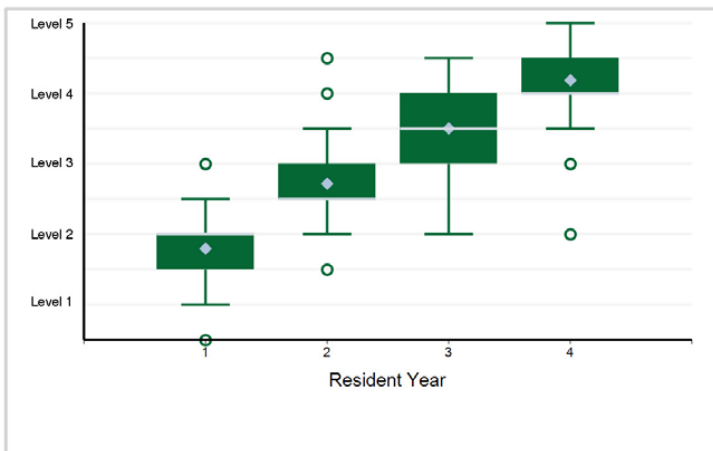

14. Systems-Based Practice - Systems-Based Practice 4: Physician Role in Health Care Systems

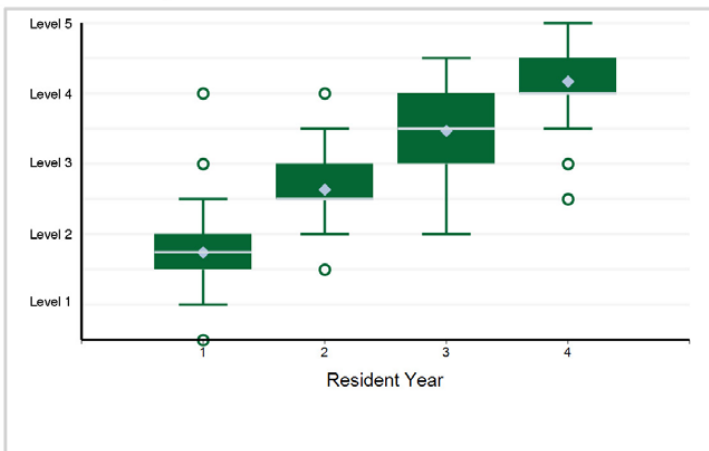

15. Practice-Based Learning and Improvement - Practice-Based Learning and Improvement 1: Evidence-Based and Informed Practice

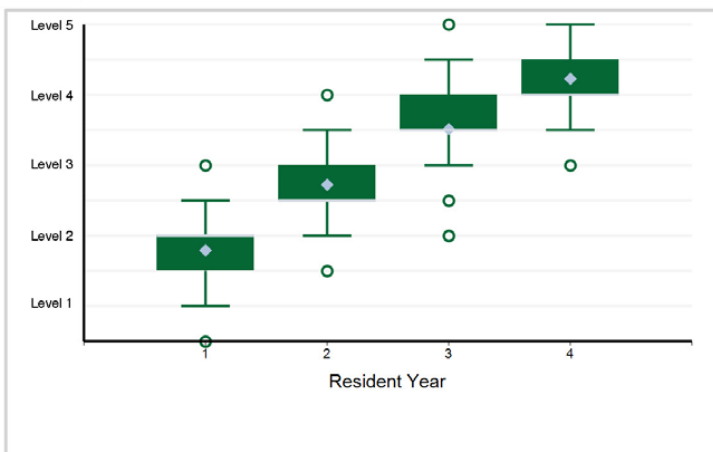

16. Practice-Based Learning and Improvement - Practice-Based Learning and Improvement 2: Reflective Practice and Commitment ...

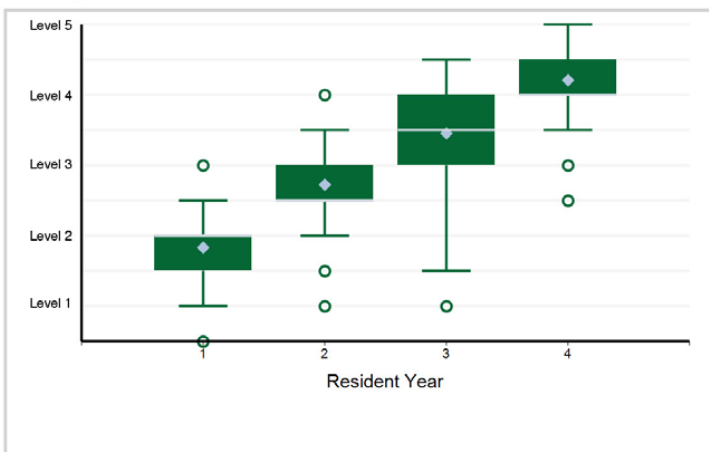

17. Professionalism - Professionalism 1: Professional Behavior and Ethical Principles

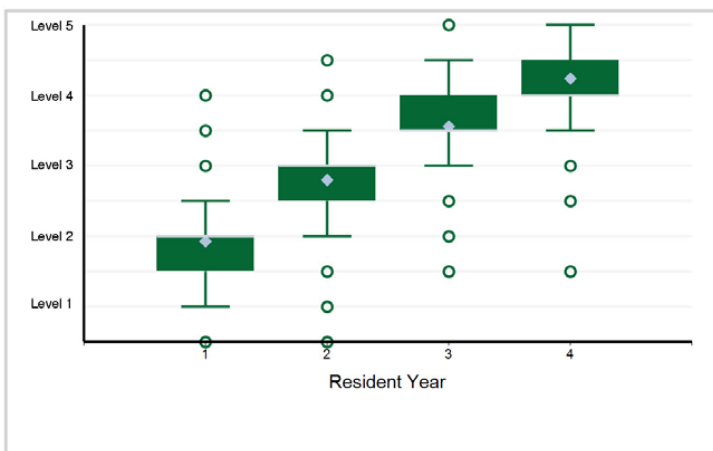

18. Professionalism - Professionalism 2: Accountability/Conscientiousness

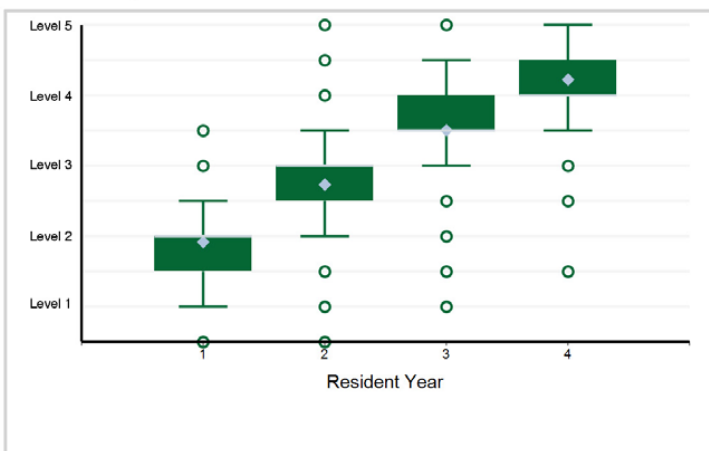

Specialty Box Plot Report - Milestone Evaluation by Resident Year: Year-End 2021-2022

SPECIALTY: Emergency Medicine (Four-Year Program)

19. Professionalism - Professionalism 3: Self-Awareness and Well-Being

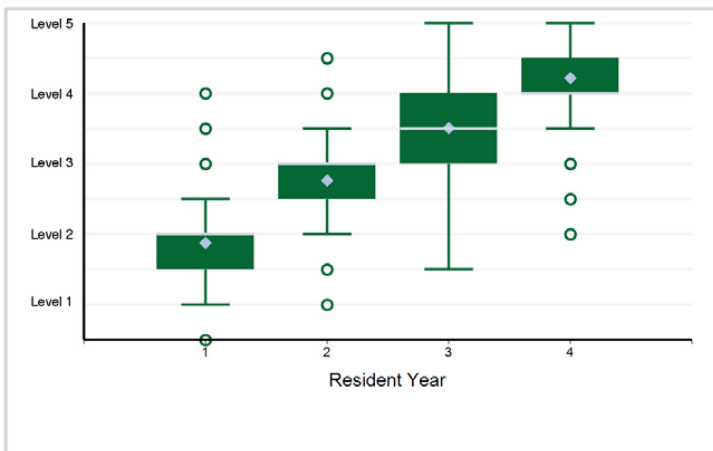

20. Interpersonal and Communication Skills - Interpersonal and Communication Skills 1: Patient- and Family-Centered Communication

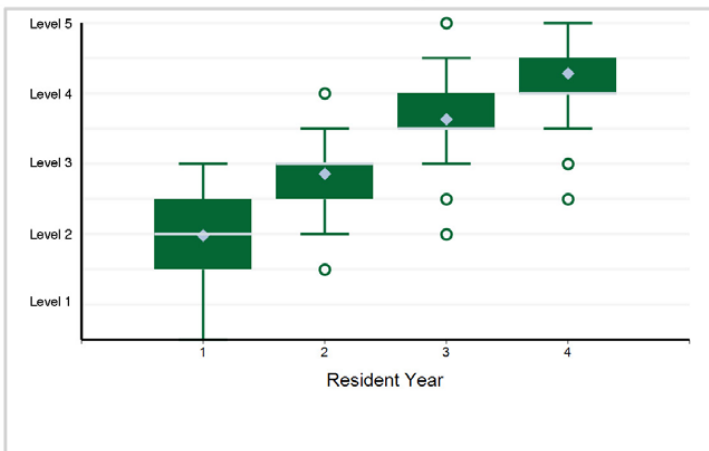

21. Interpersonal and Communication Skills - Interpersonal and Communication Skills 2: Interprofessional and Team Communication

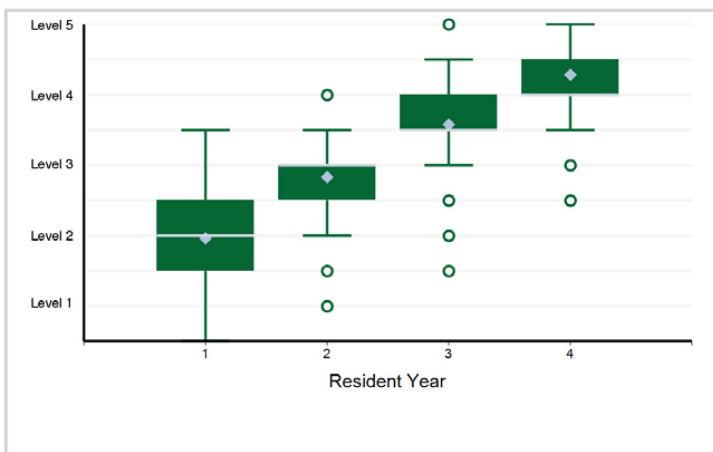

22. Interpersonal and Communication Skills - Interpersonal and Communication Skills 3: Communication within Health Care Systems

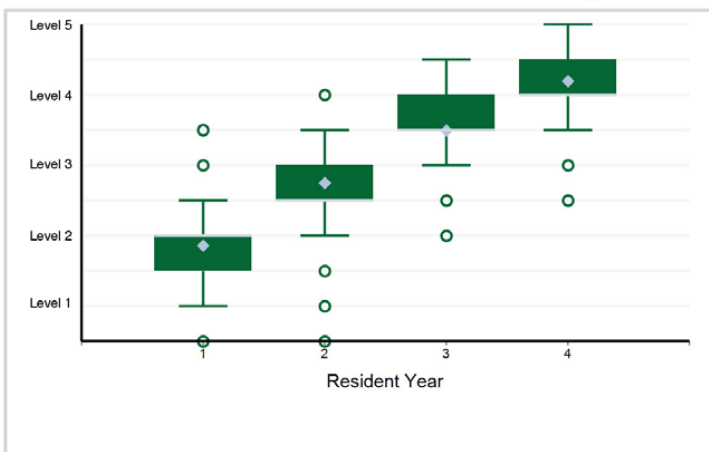

Specialty Box Plot Report - Milestone Evaluation by Resident Year: Year-End 2021-2022

TABLE 18: SUBSPECIALTY: **Emergency Medical Services**

Resident Year	1	Total Residents
# of Residents	107	107

1. Patient Care - Procedures Performed in the Pre-hospital Environment

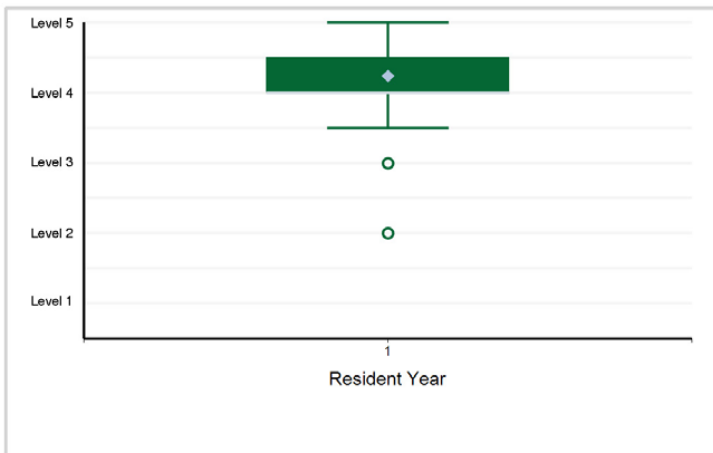

2. Patient Care - Pre-hospital Recognition and Stabilization of Time/Life-Critical Conditions – Patient Care

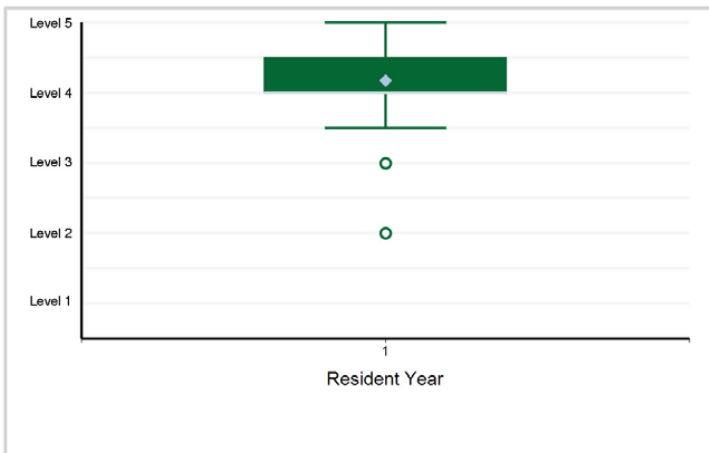

3. Patient Care - Recognition and Treatment of Pre-hospital Conditions – Patient Care

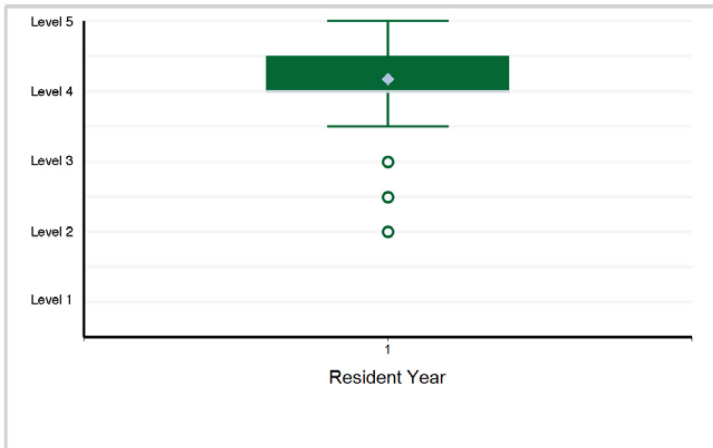

4. Patient Care - Mass Casualty and Disaster Management – Patient Care



5. Patient Care - General Special Operations in Emergency Medical Services (EMS) – Patient Care

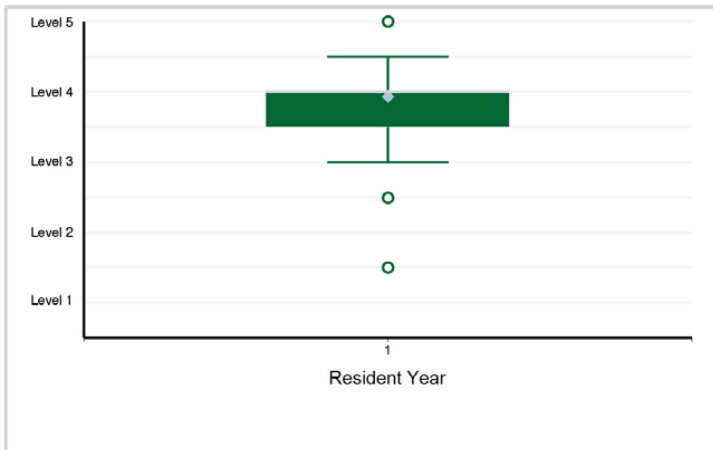

6. Medical Knowledge - Medical Oversight – Medical Knowledge

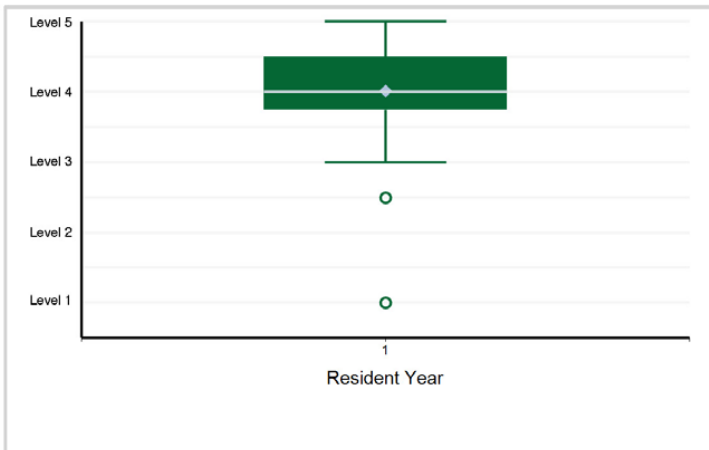

Specialty Box Plot Report - Milestone Evaluation by Resident Year: Year-End 2021-2022

SUBSPECIALTY: Emergency Medical Services

7. Systems-Based Practice - EMS Personnel (Supervision and Training) – Systems-Based Practice

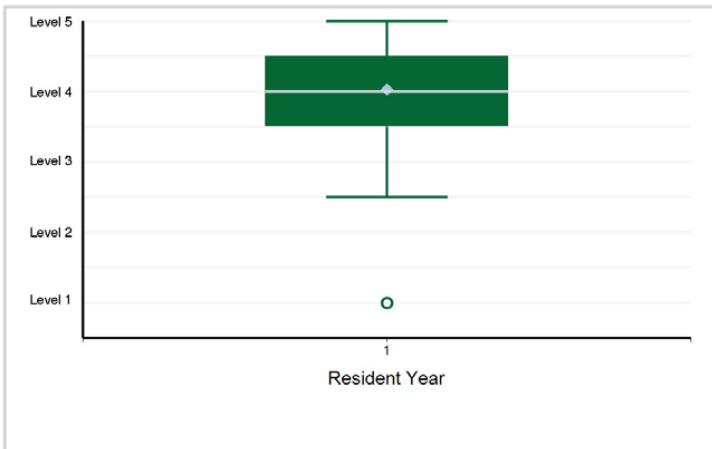

8. Systems-Based Practice - System Management – Systems-Based Practice



9. Practice-Based Learning and Improvement - Quality Management – Practice-Based Learning and Improvement

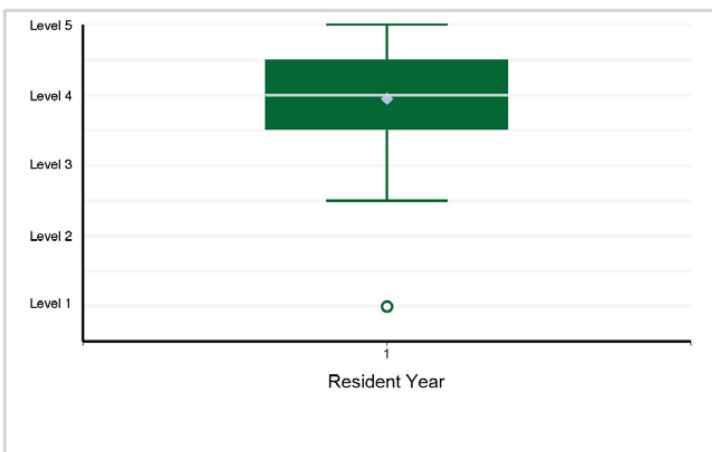

10. Practice-Based Learning and Improvement - Research – Practice-Based Learning and Improvement



11. Professionalism - Ethics and Professional Behavior – Professionalism

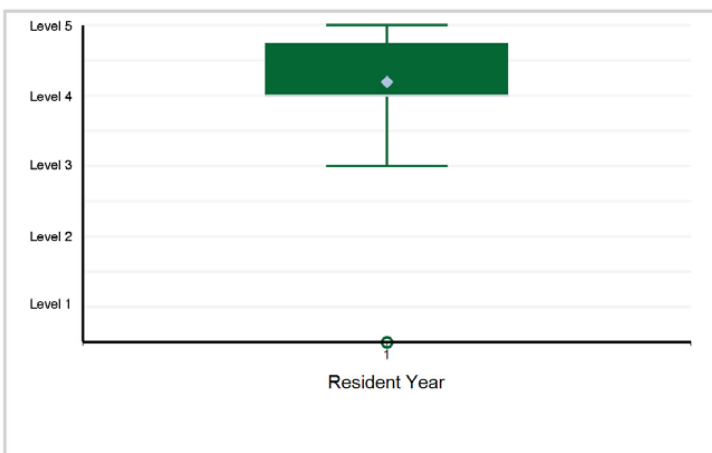

12. Professionalism - Accountability – Professionalism

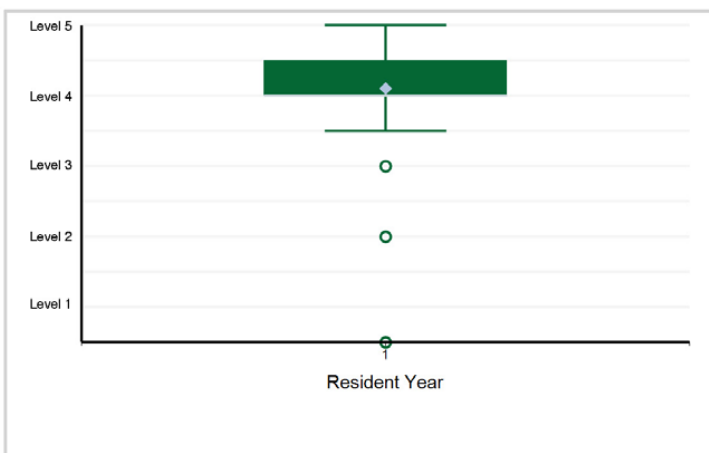

Specialty Box Plot Report - Milestone Evaluation by Resident Year: Year-End 2021-2022

SUBSPECIALTY: Emergency Medical Services

13. Interpersonal and Communication Skills - Team Communications and Management – Interpersonal and Communication Skills

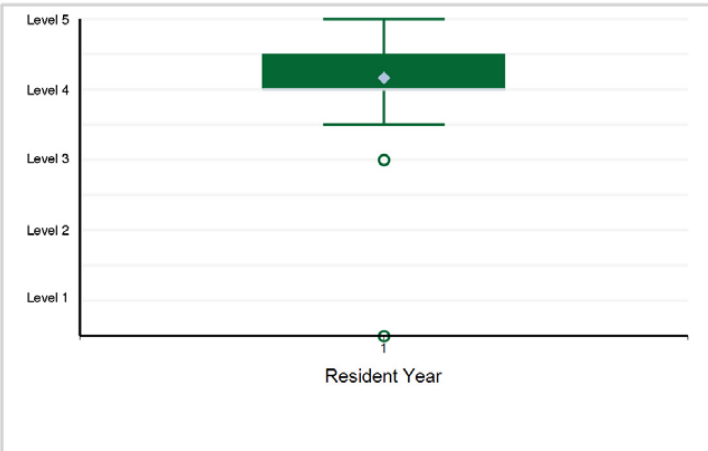

14. Interpersonal and Communication Skills - Patient-centered Communications – Interpersonal and Communication Skills

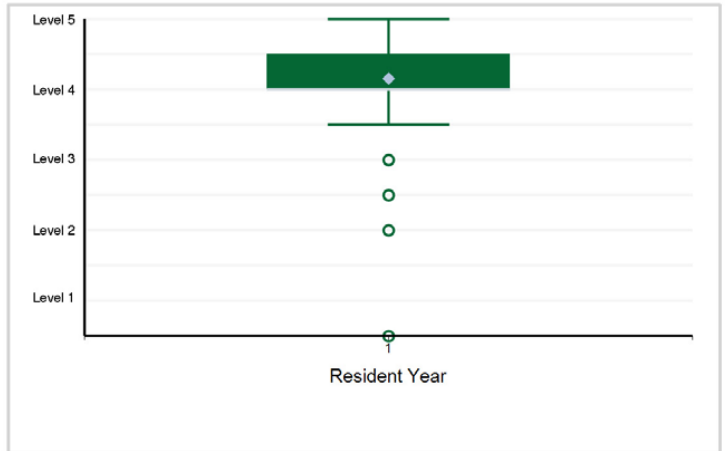

Specialty Box Plot Report - Milestone Evaluation by Resident Year: Year-End 2021-2022

TABLE 19: SUBSPECIALTY: **Medical Toxicology (multidisciplinary, Emergency Medicine)**

Resident Year	1	2	Total Residents*
# of Residents	38	43	81

*Note: There are 1 residents with an incomplete milestone evaluation that are excluded from the box plots below.

1. Patient Care - PC1: Exposure Assessment: History and Physical

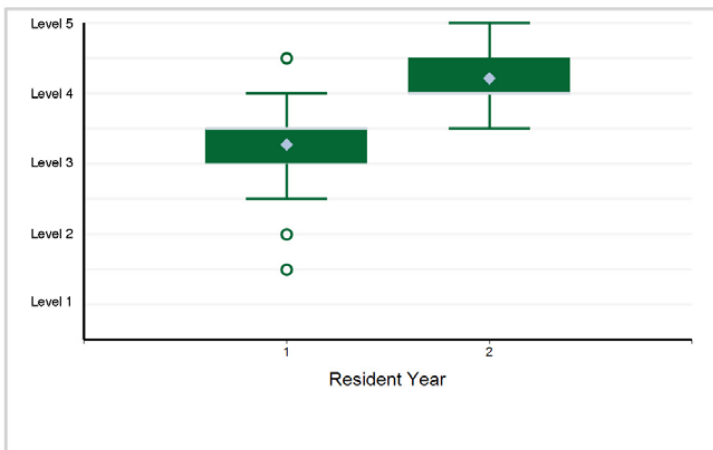

2. Patient Care - PC2: Clinical Reasoning: Ordering and Interpretation of Studies and Differential Diagnosis

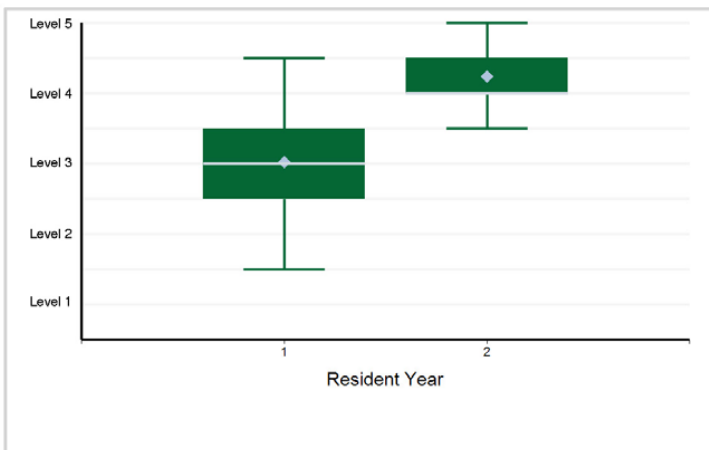

3. Patient Care - PC3: Management Plan and Treatment

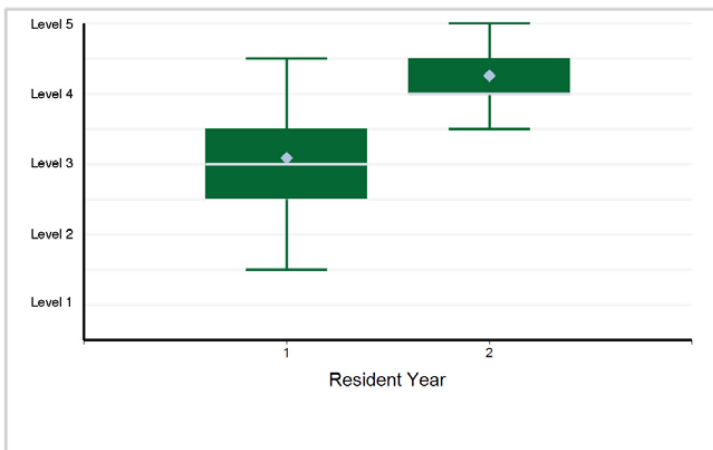

4. Medical Knowledge - MK1: Acute and Chronic Exposure

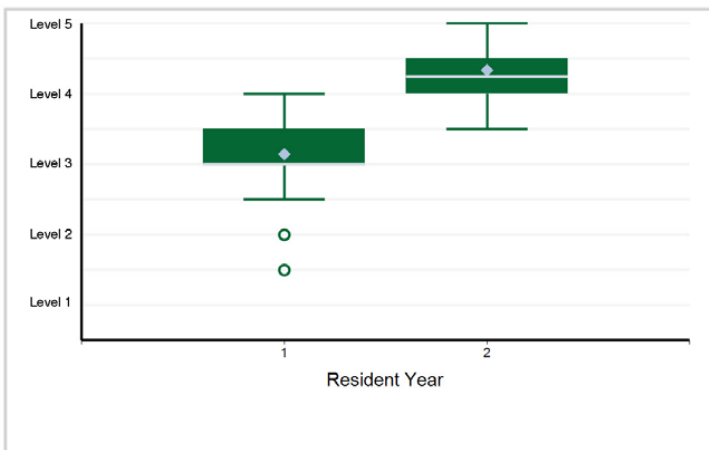

5. Medical Knowledge - MK2: Epidemiology and Population Exposure

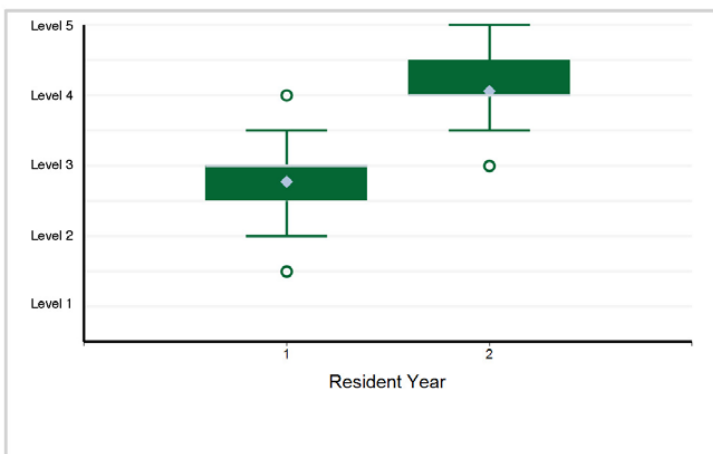

6. Medical Knowledge - MK3: Laboratory and Clinical Testing

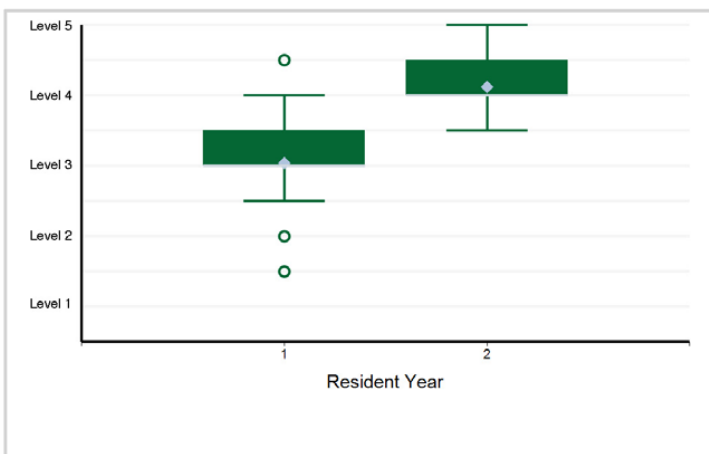

Specialty Box Plot Report - Milestone Evaluation by Resident Year: Year-End 2021-2022

SUBSPECIALTY: **Medical Toxicology (multidisciplinary, Emergency Medicine)**

7. Systems-Based Practice - SBP1: Patient Safety

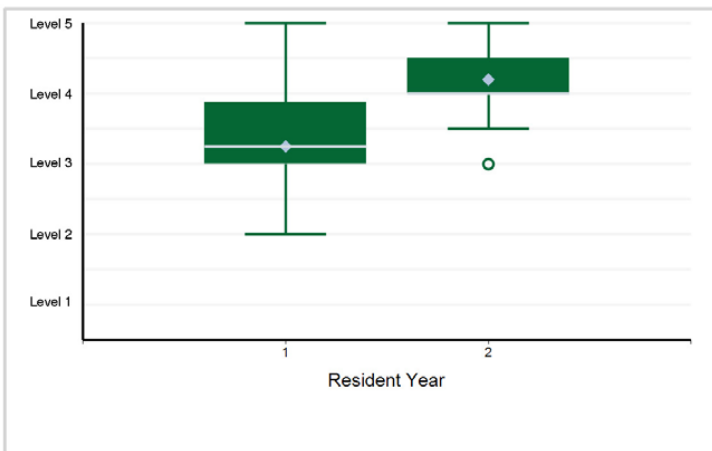

8. Systems-Based Practice - SBP2: Clinical Application of Information Technology

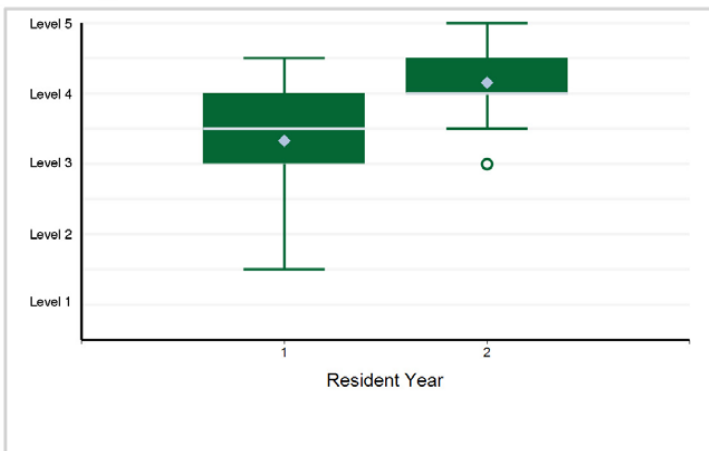

9. Practice-Based Learning and Improvement - PBL1: Self-Directed Learning in Medical Toxicology

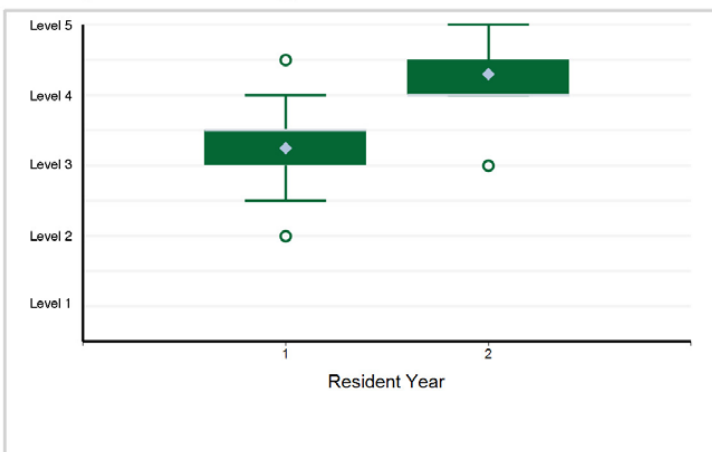

10. Practice-Based Learning and Improvement - PBL2: Quality Improvement Project

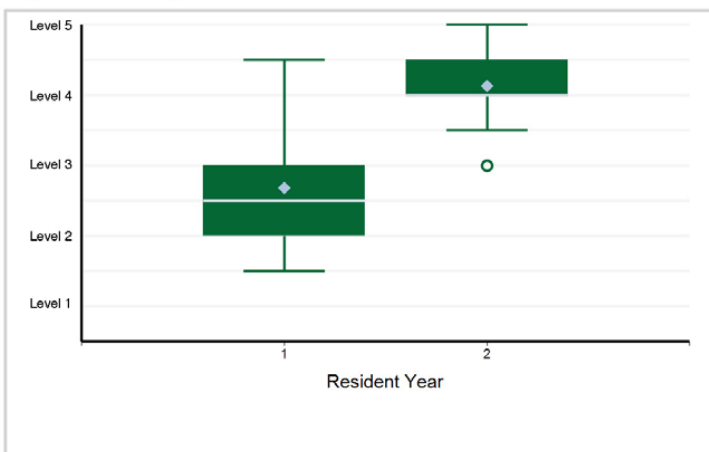

11. Professionalism - PROF1: Professional Values

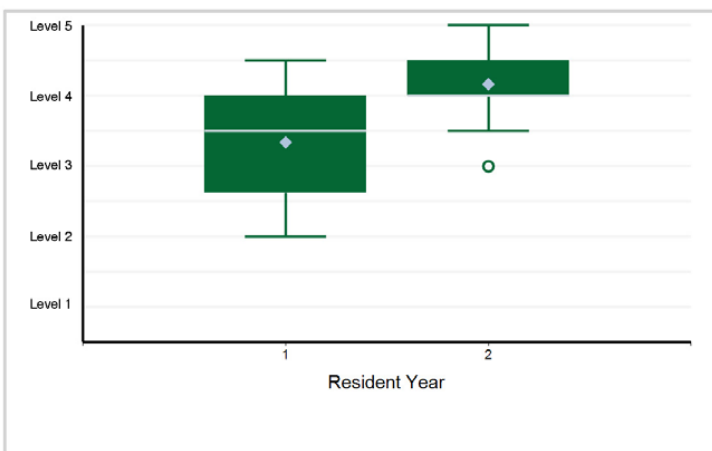

12. Professionalism - PROF2: Accountability to patients, society, profession, and self

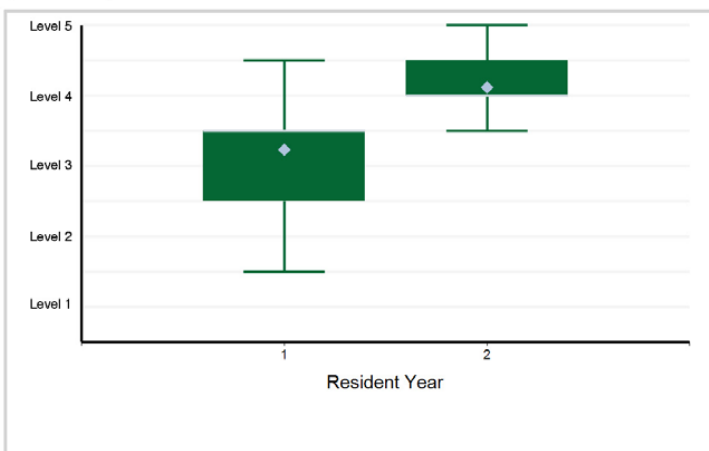

Specialty Box Plot Report - Milestone Evaluation by Resident Year: Year-End 2021-2022

SUBSPECIALTY: **Medical Toxicology (multidisciplinary, Emergency Medicine)**

13. Interpersonal and Communication Skills - ICS1: Patients Families and Public

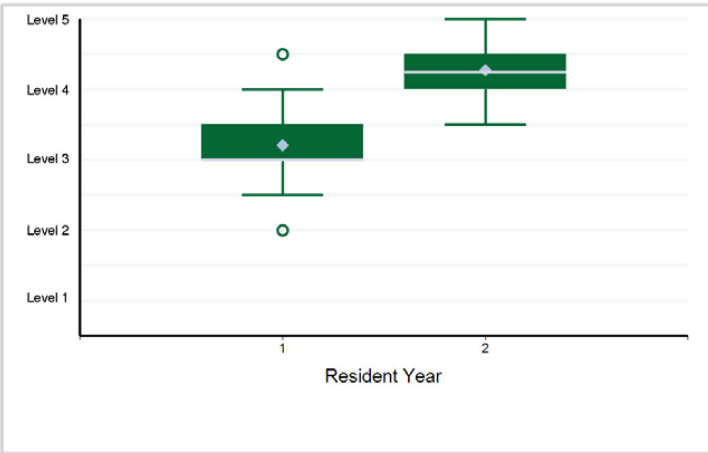

14. Interpersonal and Communication Skills - ICS2: Communication with Health Care Professionals

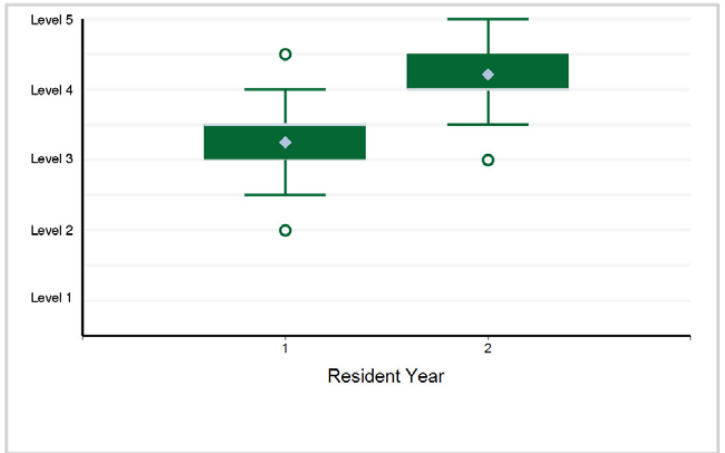

Specialty Box Plot Report - Milestone Evaluation by Resident Year: Year-End 2021-2022

TABLE 20: SUBSPECIALTY: **Pediatric Emergency Medicine (multidisciplinary, Emergency Medicine)**

Resident Year	1	2	3	Total Residents*
# of Residents	58	45	37	140

*Note: There are 6 residents with an incomplete milestone evaluation that are excluded from the box plots below.

1. Patient Care - Gather essential and accurate information about the patient: Abstracts current findings ...

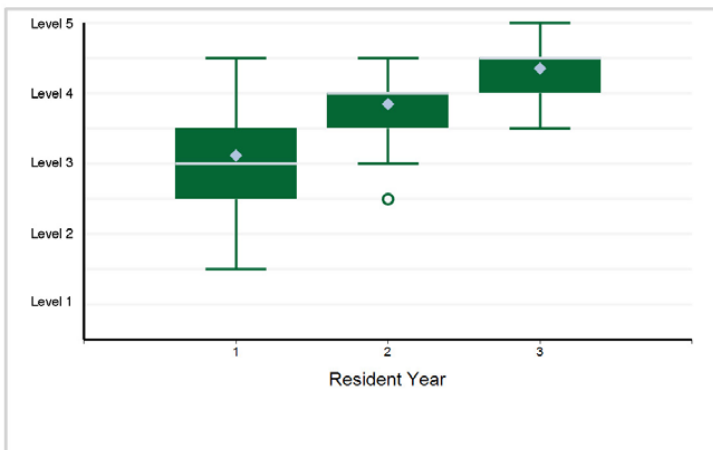

2. Patient Care - Organize and prioritize responsibilities to provide patient care that is safe, effective, ...

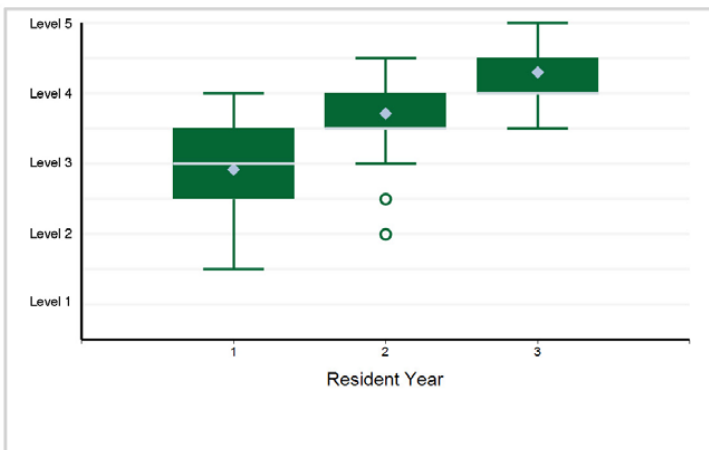

3. Patient Care - Provide transfer of care that ensures seamless transitions — PC3

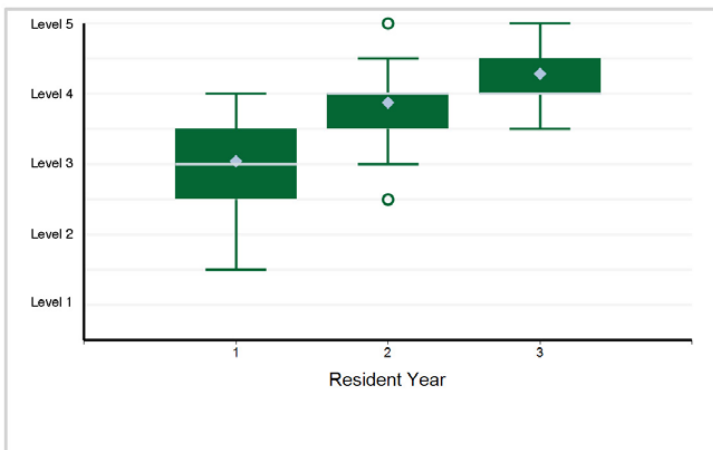

4. Patient Care - Make informed diagnostic and therapeutic decisions that result in optimal clinical judgment — PC4

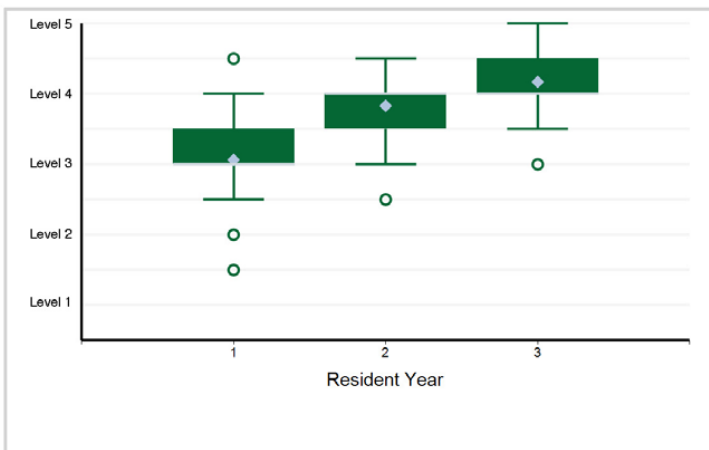

5. Patient Care - Emergency Stabilization: Prioritizes critical initial stabilization action and mobilizes ...

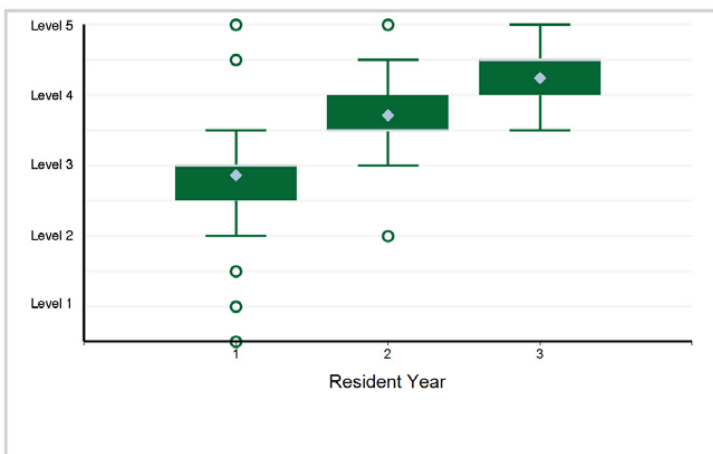

6. Patient Care - Diagnostic Studies: Applies the results of diagnostic testing based on the probability ...

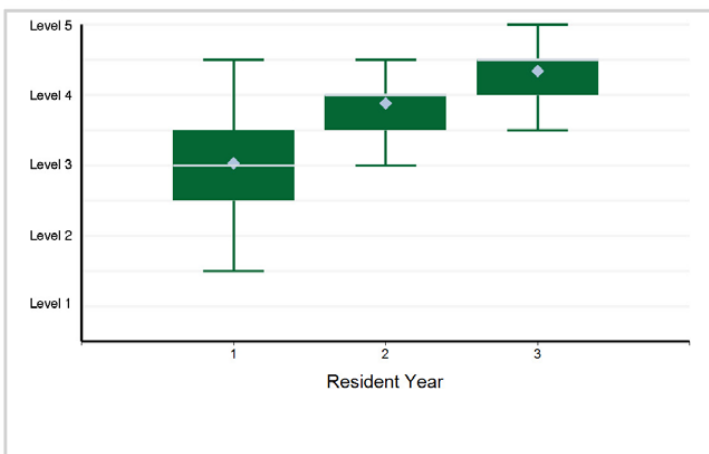

Specialty Box Plot Report - Milestone Evaluation by Resident Year: Year-End 2021-2022

SUBSPECIALTY: Pediatric Emergency Medicine (multidisciplinary, Emergency Medicine)

7. Patient Care - Observation and Reassessment: Re-evaluates patients undergoing emergency department (ED) ...

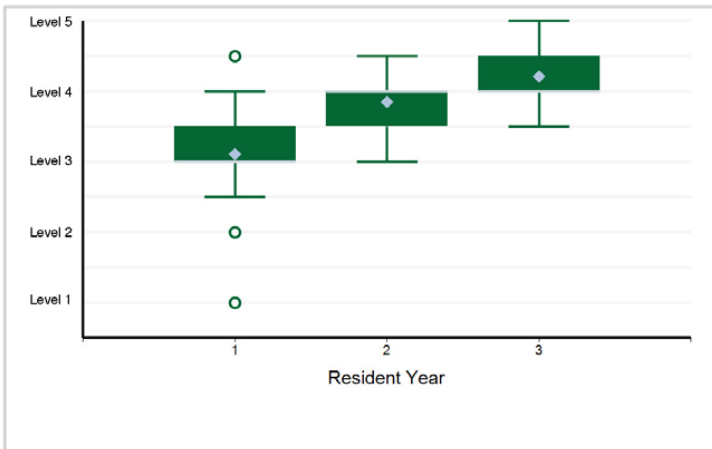

8. Patient Care - Disposition: Establishes and implements a comprehensive disposition plan that uses appropriate ...

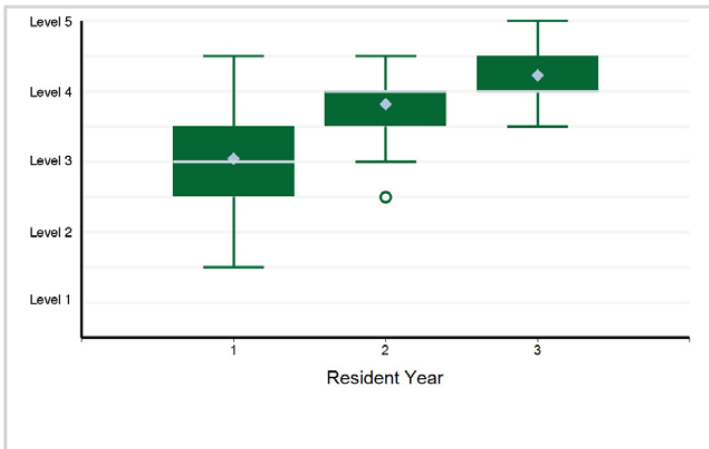

9. Patient Care - General Approach to Procedures: Performs the indicated procedure on all appropriate patients ...

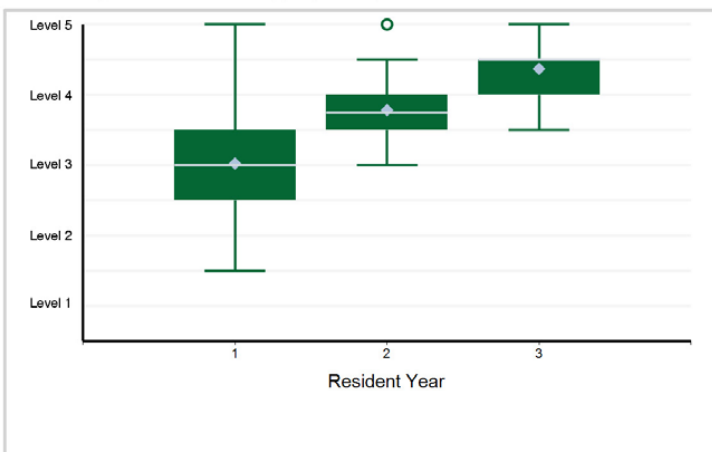

10. Patient Care - Anesthesia and Acute Pain Management: Provides safe acute pain management, anesthesia, ...

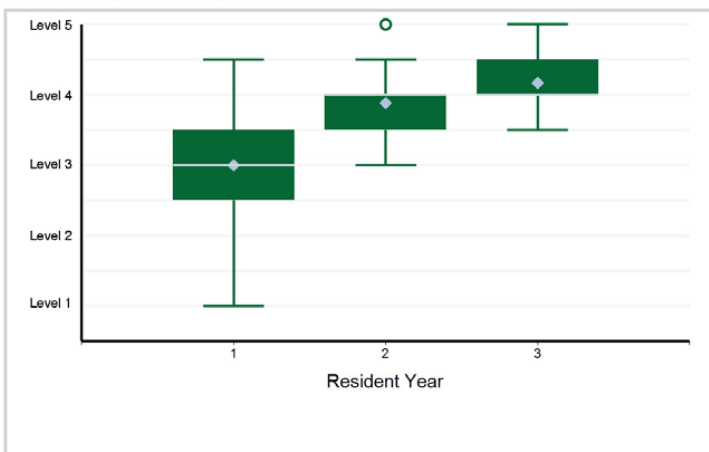

11. Patient Care - Provide appropriate supervision (milestones for the supervisor) — PC11

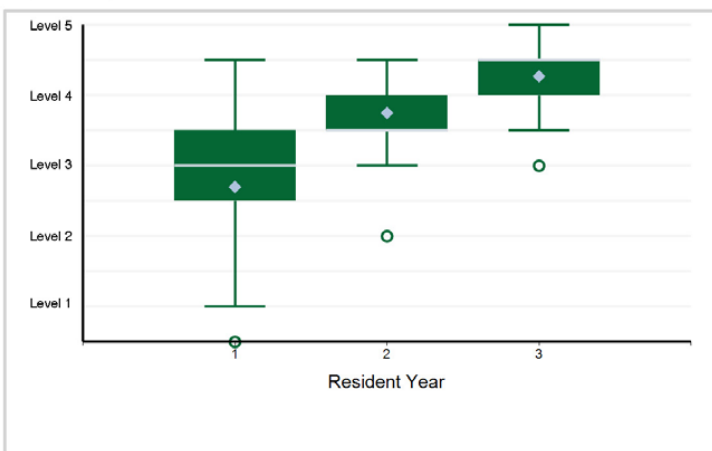

12. Medical Knowledge - Demonstrate sufficient knowledge of the basic and clinically supportive sciences ...

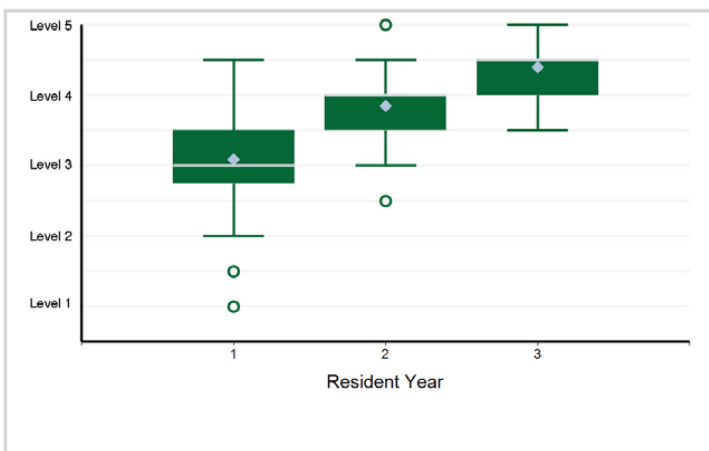

Specialty Box Plot Report - Milestone Evaluation by Resident Year: Year-End 2021-2022

SUBSPECIALTY: Pediatric Emergency Medicine (multidisciplinary, Emergency Medicine)

13. Systems-Based Practice - Advocate for quality patient care and optimal patient care systems — SBP1

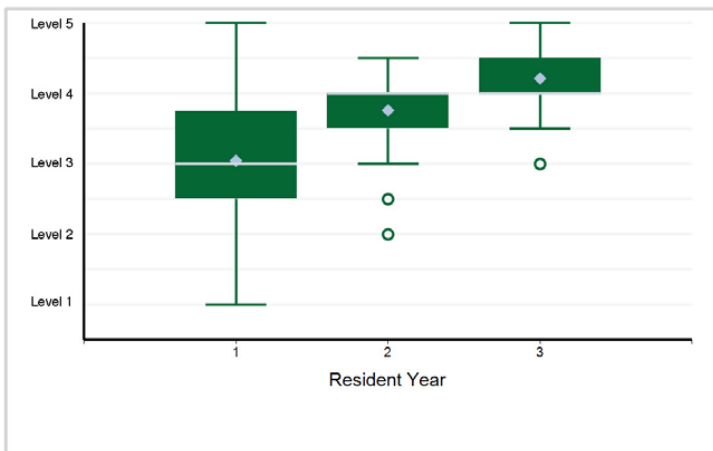

14. Systems-Based Practice - Participate in identifying system errors and implementing potential systems solutions — SBP2

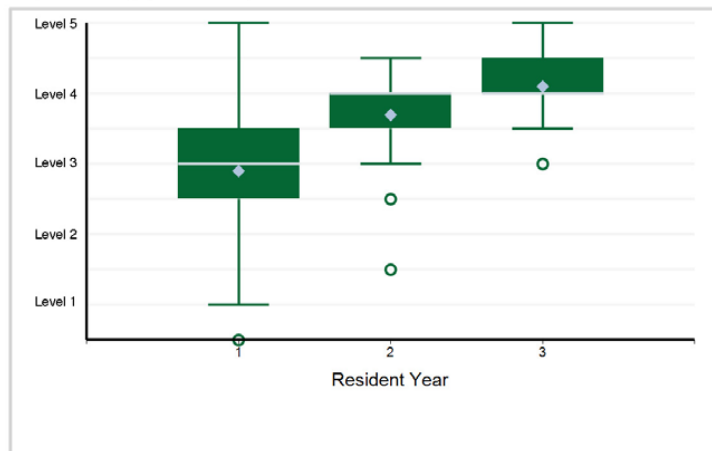

15. Practice-Based Learning and Improvement - Use information technology to optimize learning and care delivery — PBL1

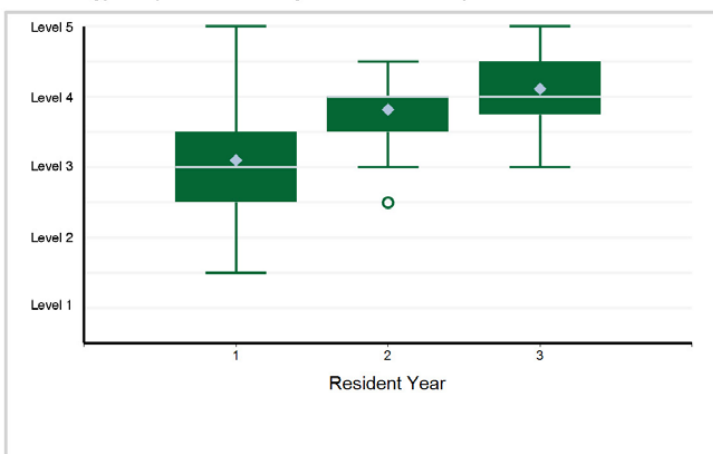

16. Professionalism - Self-awareness of one's own knowledge, skill, and emotional limitations that leads ...

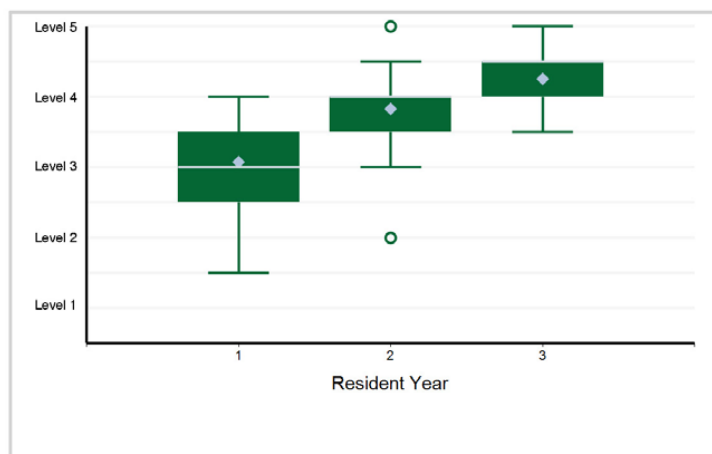

17. Professionalism - The capacity to accept that ambiguity is part of clinical medicine and to recognize ...

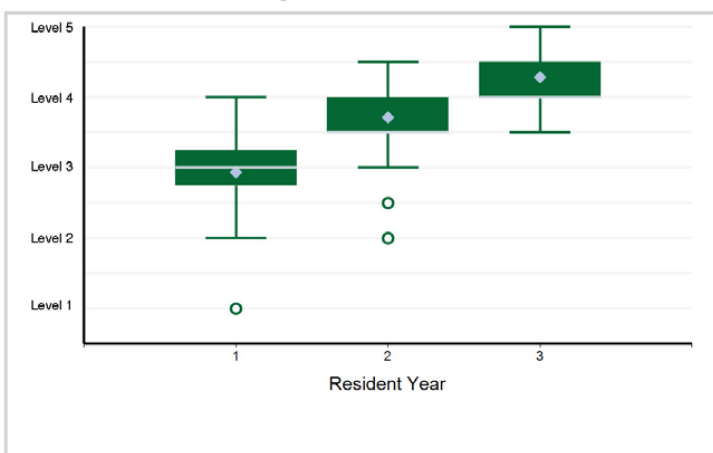

18. Professionalism - Practice flexibility and maturity in adjusting to change with the capacity to alter behavior — PROF3

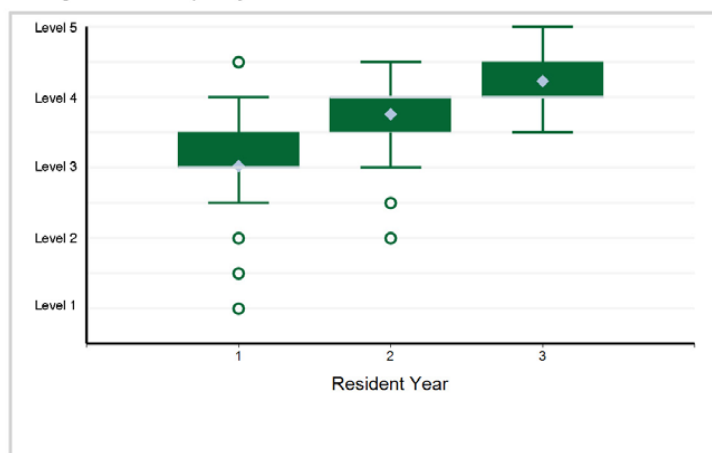

Specialty Box Plot Report - Milestone Evaluation by Resident Year: Year-End 2021-2022

SUBSPECIALTY: Pediatric Emergency Medicine (multidisciplinary, Emergency Medicine)

19. Professionalism - Provide leadership skills that enhance team functioning, the learning environment, ...

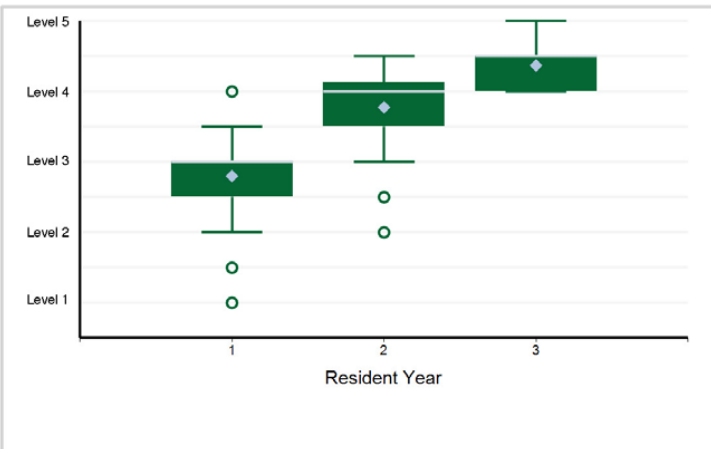

20. Professionalism - Demonstrate self-confidence that puts patients, families, and members of the health care team at ease ...

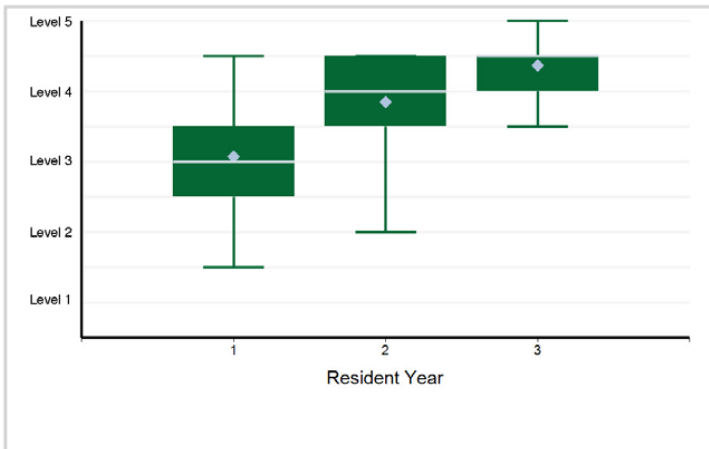

21. Interpersonal and Communication Skills - Communicate effectively with patients, families, and the public, ...

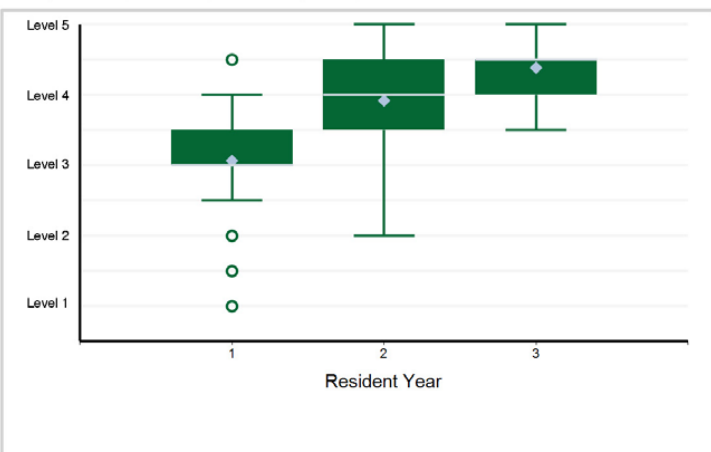

22. Interpersonal and Communication Skills - Demonstrate the insight and understanding into emotion and ...

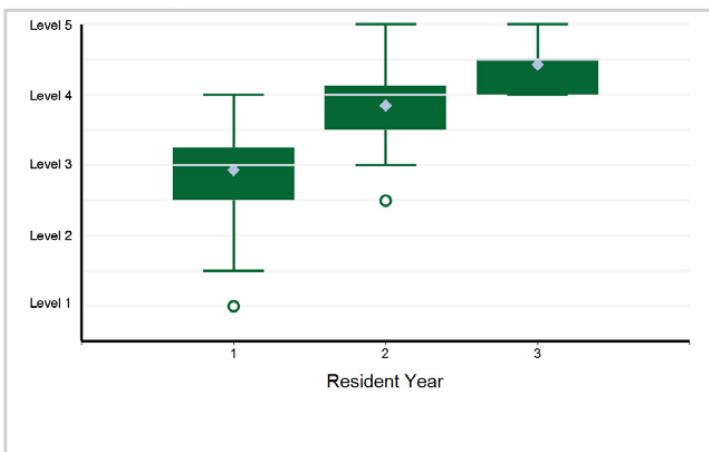

23. Interpersonal and Communication Skills - Act in a consultative role to other physicians and health professionals — ICS3

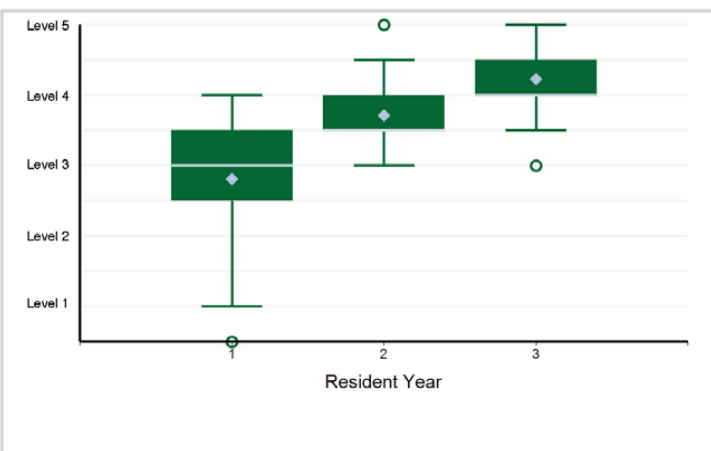

Specialty Box Plot Report - Milestone Evaluation by Resident Year: Year-End 2021-2022

TABLE 21: SUBSPECIALTY: **Sports Medicine (multidisciplinary, Emergency Medicine)**

Resident Year	1	Total Residents*
# of Residents	18	18

*Note: There are 1 residents with an incomplete milestone evaluation that are excluded from the box plots below.

1. Patient Care - History and Physical Examination: Medical and Musculoskeletal — Patient Care 1

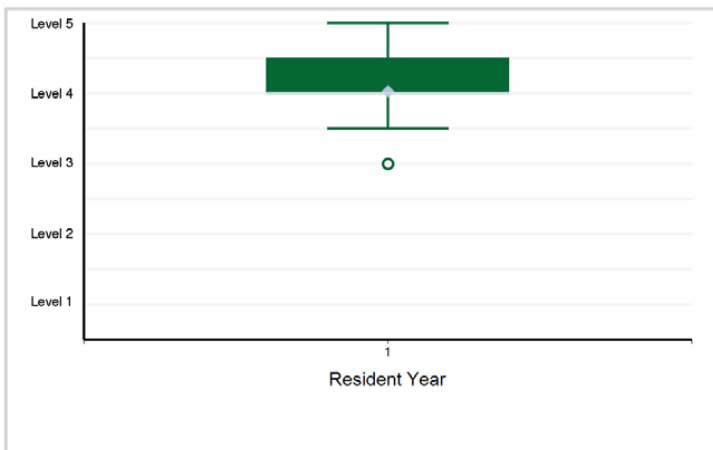

2. Patient Care - Medical Management: Differential Diagnosis, Diagnostic Testing, Interpretation of Data ...

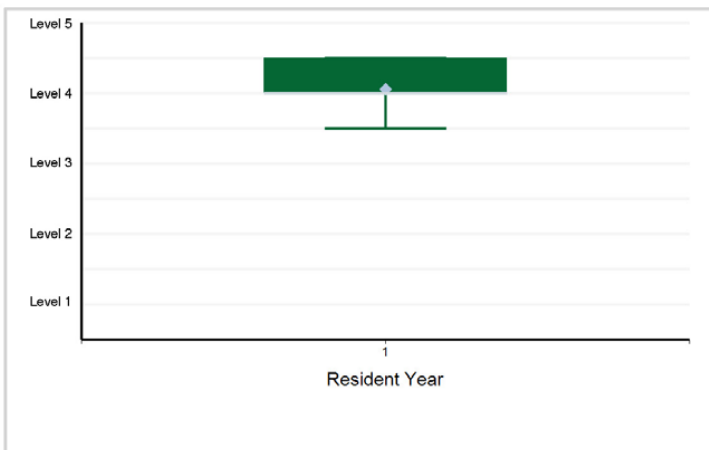

3. Patient Care - Team Coverage and Athletic Care: Coverage of Sporting Events, Pre-participation Physical ...

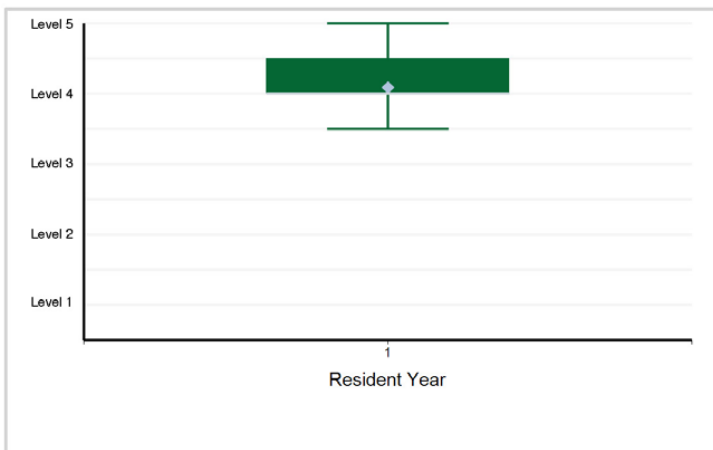

4. Medical Knowledge - Science of Sports Medicine, including Anatomy, Physiology, Cellular Biology, Epidemiology, ...

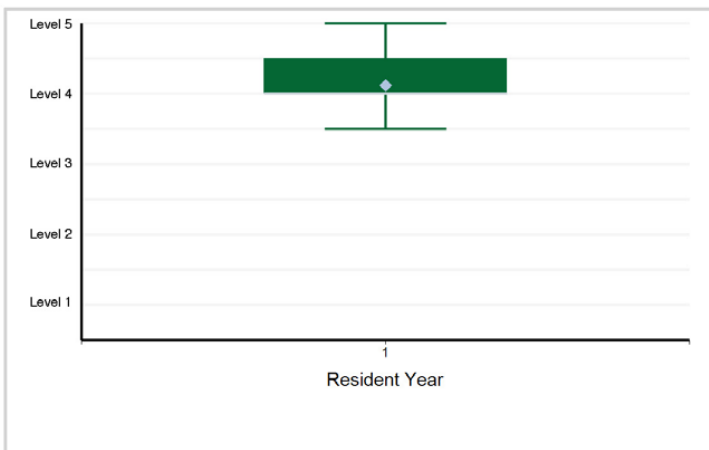

5. Medical Knowledge - Medical Issues in Sports Medicine — Medical Knowledge 2

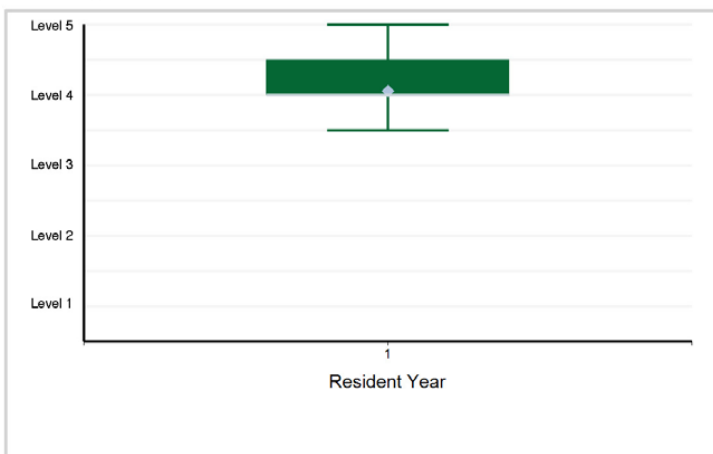

6. Medical Knowledge - Musculoskeletal Issues in Sports Medicine — Medical Knowledge 3

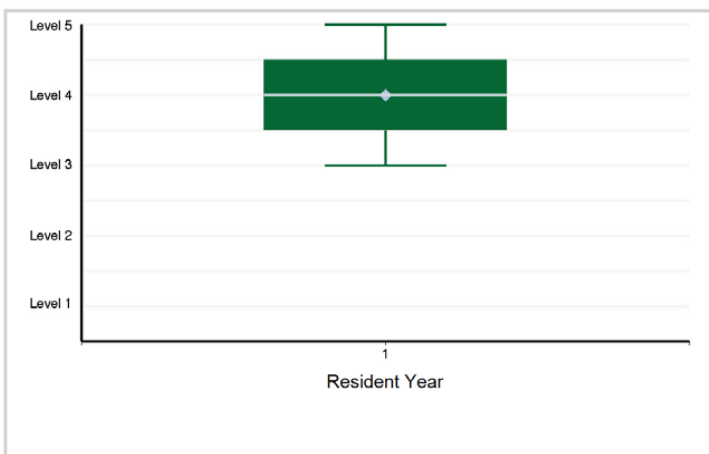

Specialty Box Plot Report - Milestone Evaluation by Resident Year: Year-End 2021-2022

SUBSPECIALTY: **Sports Medicine (multidisciplinary, Emergency Medicine)**

7. Systems-Based Practice - Working with Interprofessional Teams (consultants, certified athletic trainers ...)

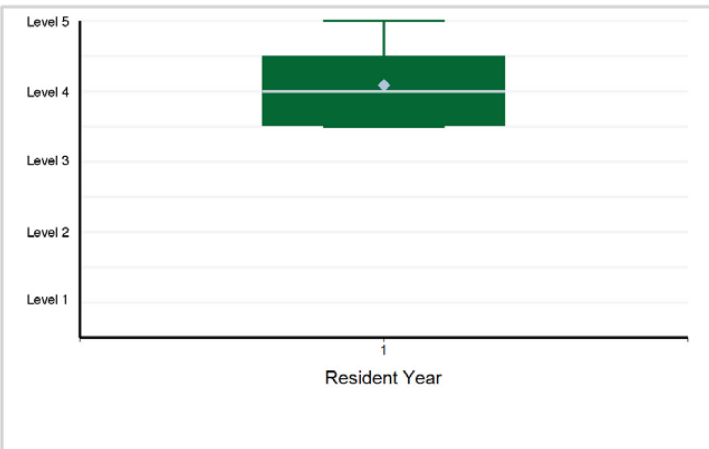

8. Systems-Based Practice - Systems Thinking — Systems-Based Practice 2

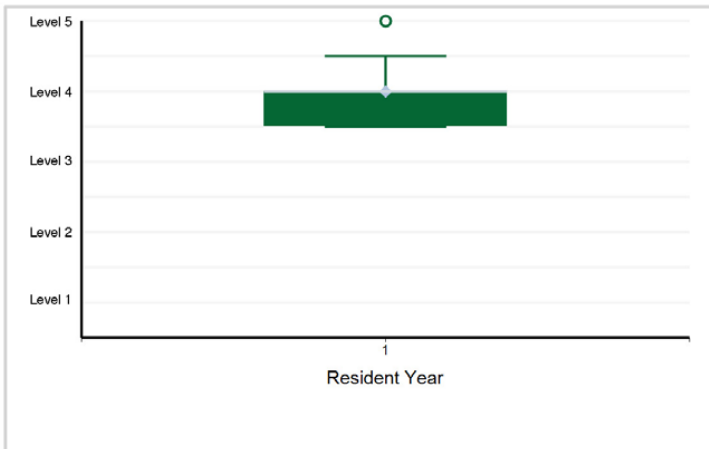

9. Practice-Based Learning and Improvement - Self-directed Learning — Practice-Based Learning and Improvement ...

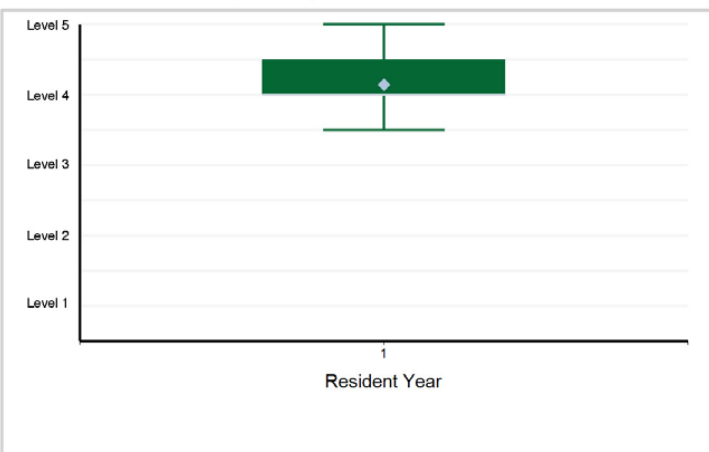

10. Practice-Based Learning and Improvement - Locate, Appraise, and Assimilate Evidence from Scientific ...

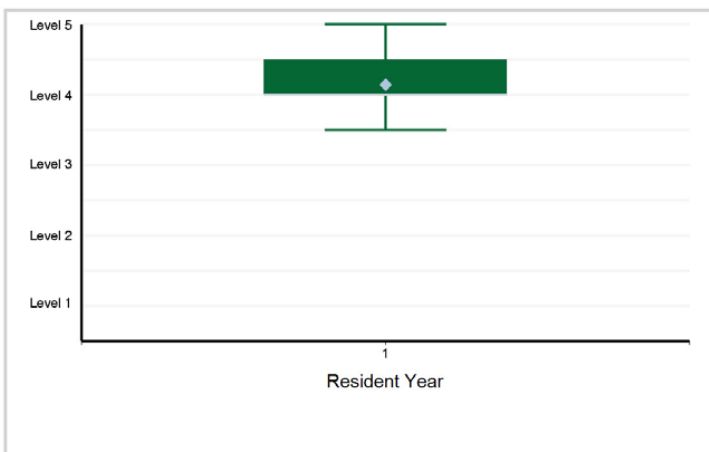

11. Professionalism - Compassion, Integrity, Accountability, and Respect for Self and Others — Professionalism 1

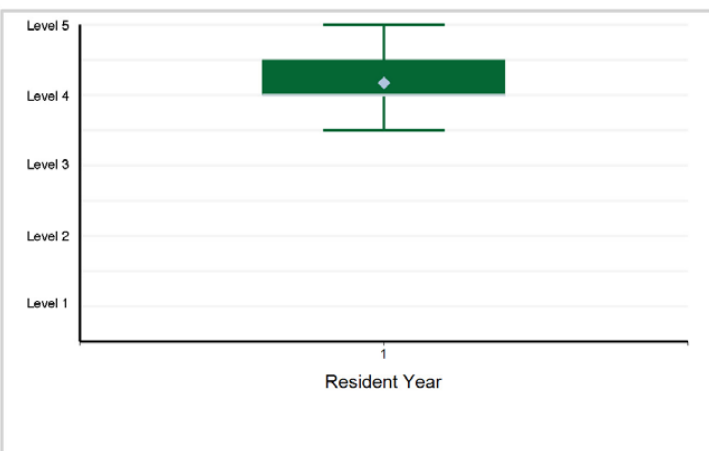

12. Professionalism - Knowledge about and Adherence to the Ethical Principles Relevant to the Practice of Sports Medicine — ...

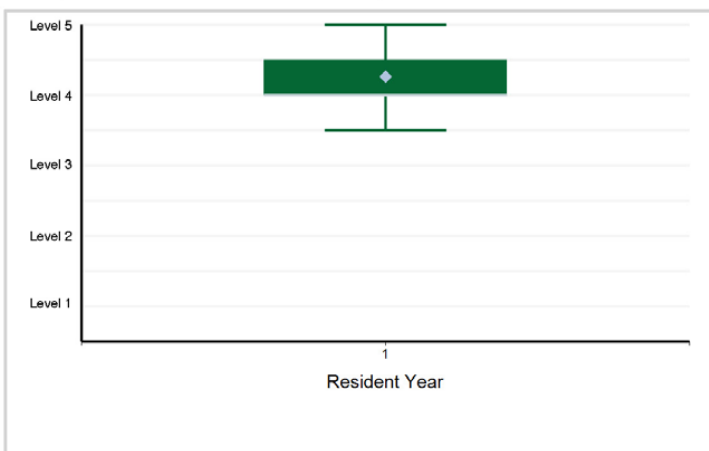

Specialty Box Plot Report - Milestone Evaluation by Resident Year: Year-End 2021-2022

SUBSPECIALTY: **Sports Medicine (multidisciplinary, Emergency Medicine)**

13. Interpersonal and Communication Skills - Relationship Development, Teamwork, and Managing Conflict — ...

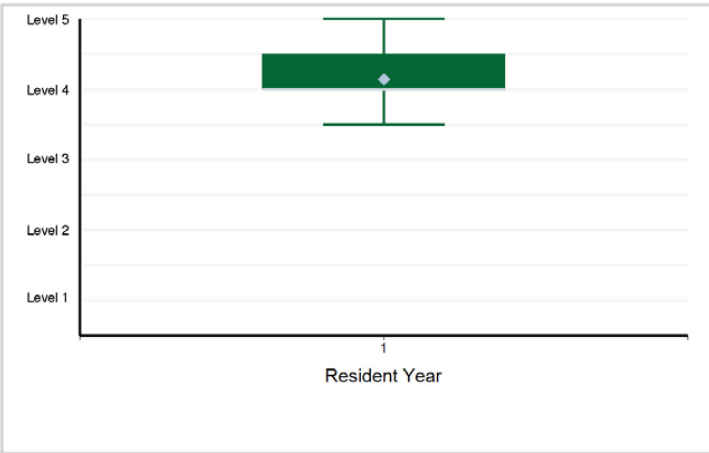

14. Interpersonal and Communication Skills - Information Sharing, Gathering, and Technology — Interpersonal ...

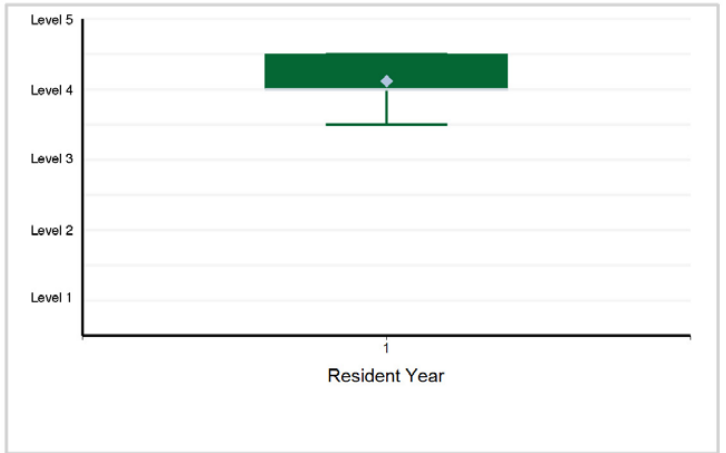

Specialty Box Plot Report - Milestone Evaluation by Resident Year: Year-End 2021-2022

TABLE 22: SUBSPECIALTY: **Undersea and Hyperbaric Medicine (multidisciplinary, Emergency Medicine)**

Resident Year	1	Total Residents
# of Residents	13	13

1. Patient Care - Fitness to Dive (Divers and Attendants) – Patient Care

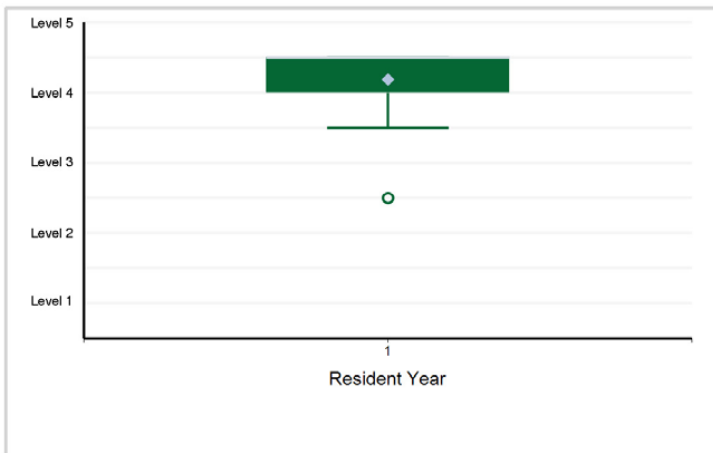

2. Patient Care - Dysbarism and Decompression Illness – Patient Care

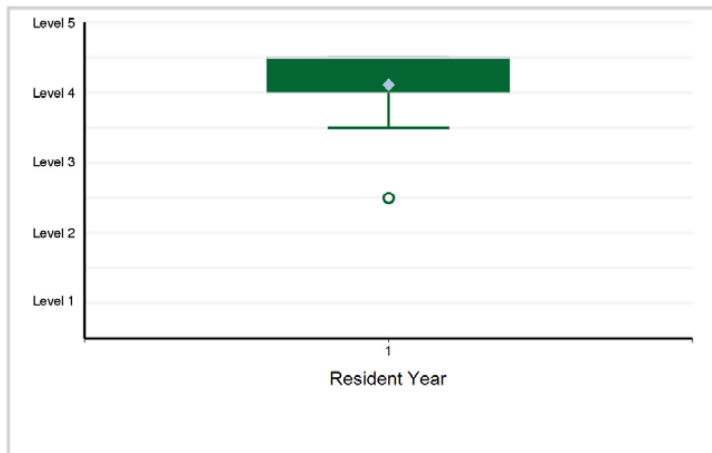

3. Patient Care - Hyperbaric Chamber Operations – Patient Care



4. Patient Care - Diving Medicine – Patient Care

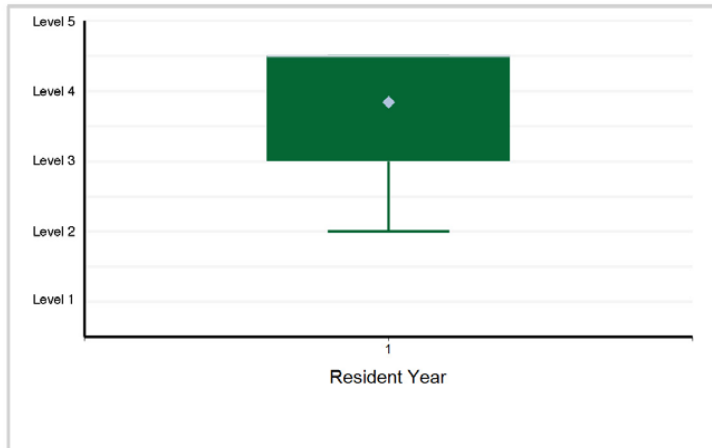

5. Medical Knowledge - Physics and Physiology of Hyperbaric and Hypobaric Exposures – Medical Knowledge

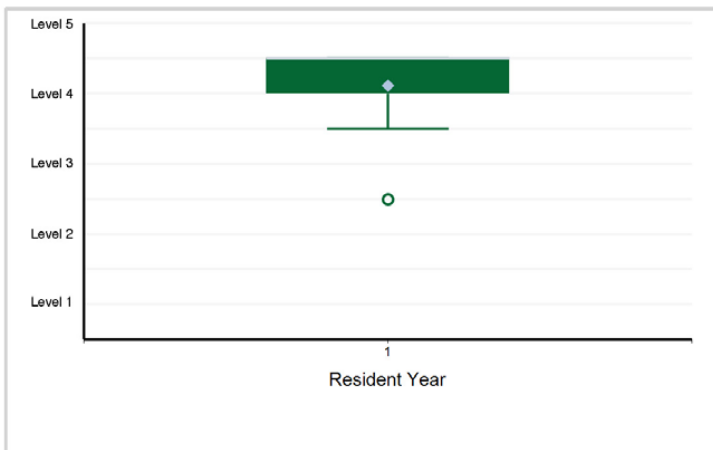

6. Medical Knowledge - Fitness to Dive – Medical Knowledge

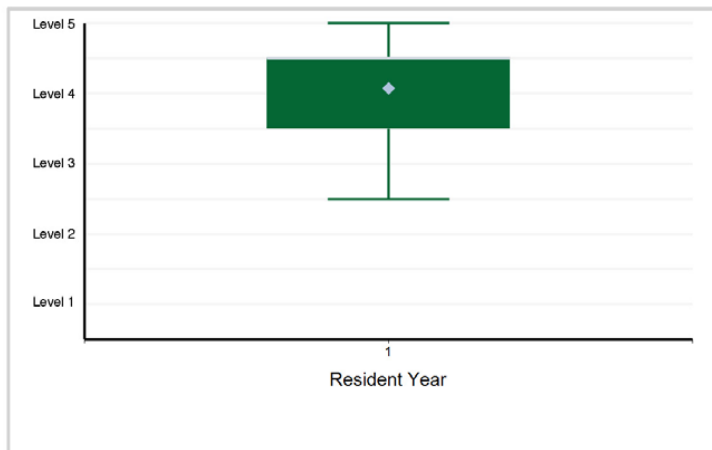

Specialty Box Plot Report - Milestone Evaluation by Resident Year: Year-End 2021-2022

SUBSPECIALTY: Undersea and Hyperbaric Medicine (multidisciplinary , Emergency Medicine)

7. Medical Knowledge - Indications for Hyperbaric Oxygen Therapy – Medical Knowledge

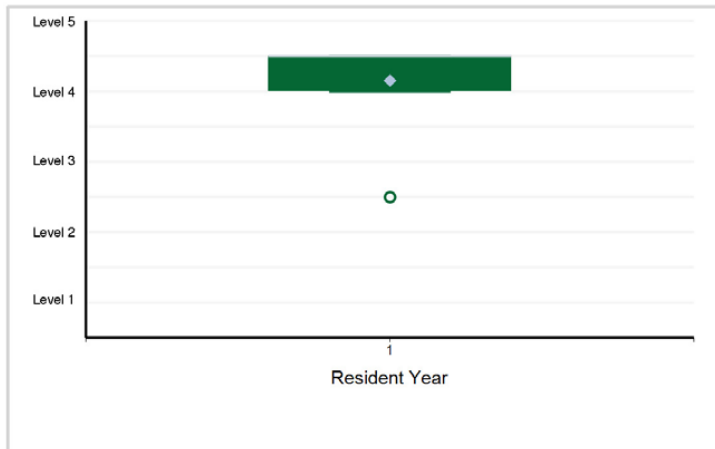

8. Medical Knowledge - Dysbarism and Decompression Illness – Medical Knowledge

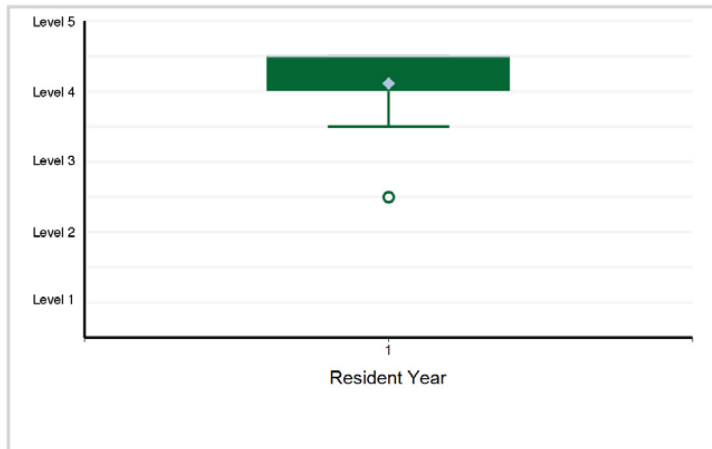

9. Medical Knowledge - Hyperbaric Chamber Operations – Medical Knowledge

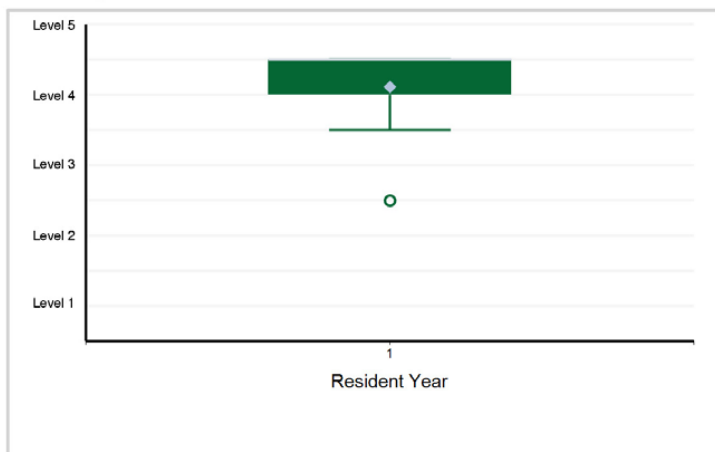

10. Medical Knowledge - Diving Medicine – Medical Knowledge

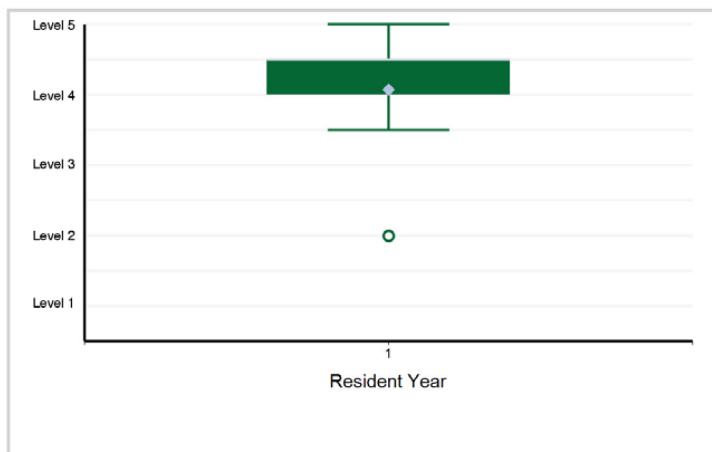

11. Systems-Based Practice - Patient Safety – Systems-Based Practice

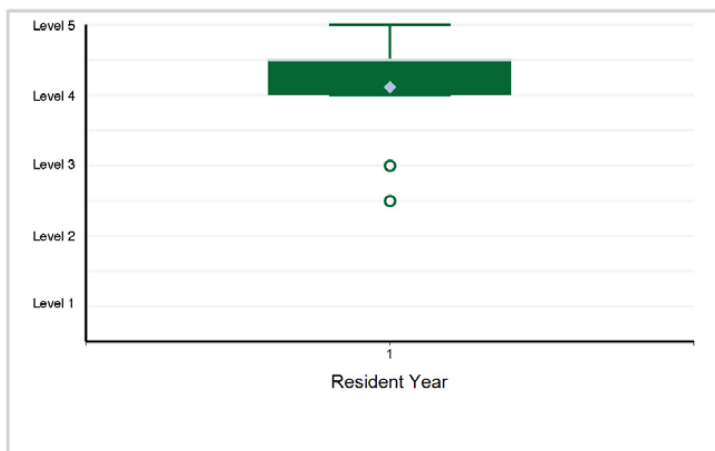

12. Systems-Based Practice - Systems-based Management – Systems-Based Practice

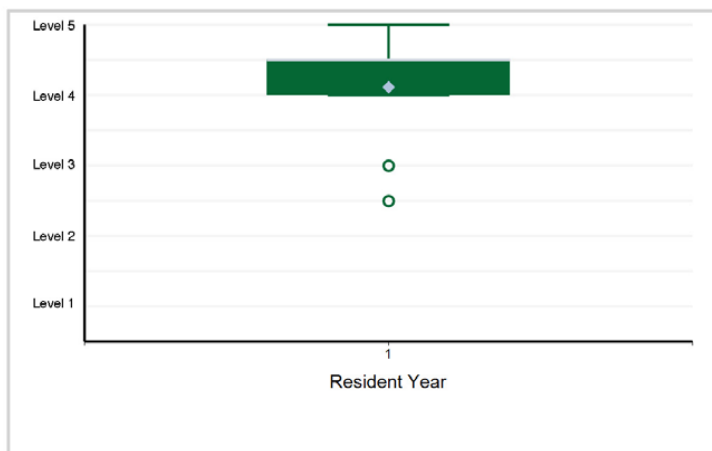

Specialty Box Plot Report - Milestone Evaluation by Resident Year: Year-End 2021-2022

SUBSPECIALTY: Undersea and Hyperbaric Medicine (multidisciplinary , Emergency Medicine)

13. Practice-Based Learning and Improvement - Self-directed Learning – Practice-Based Learning and Improvement

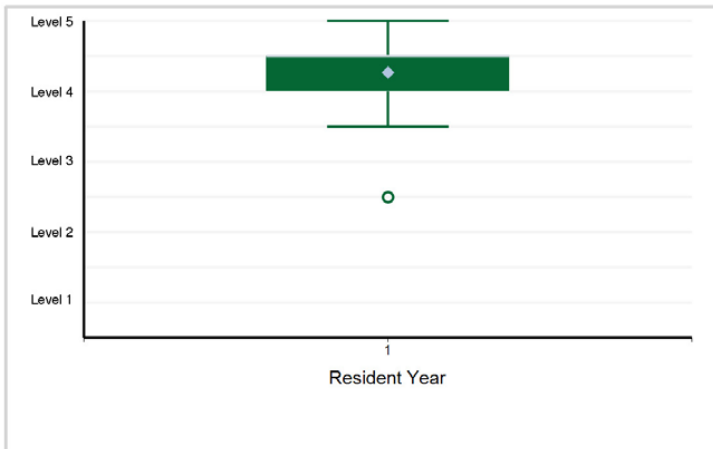

14. Professionalism - Professional Values – Professionalism

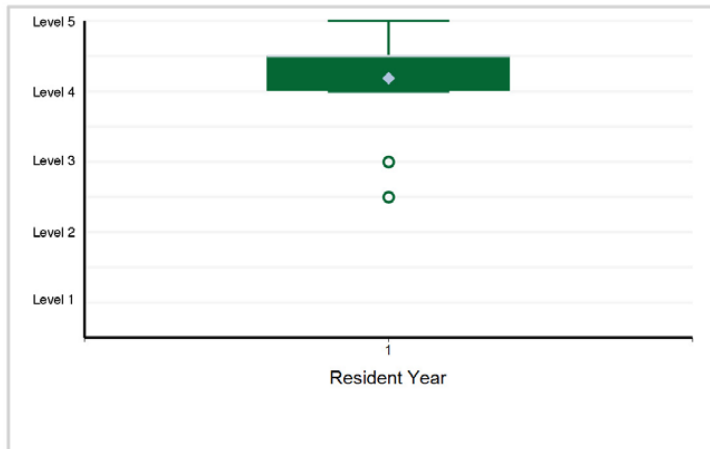

15. Professionalism - Accountability to Patients, Society, Profession, and Self – Professionalism

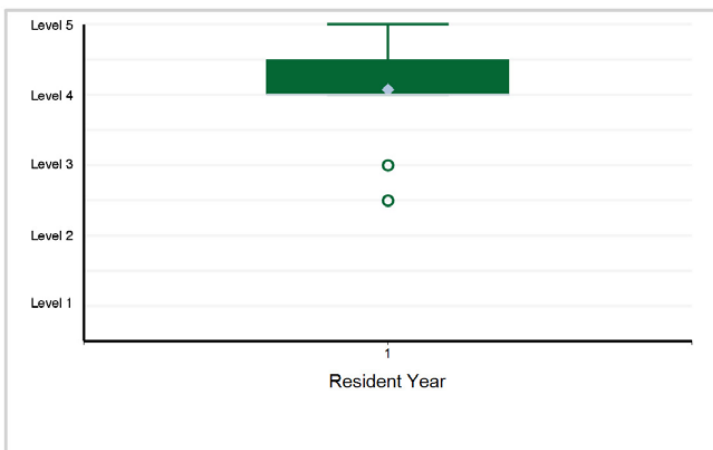

16. Interpersonal and Communication Skills - Patients, Families, and Public – Interpersonal and Communication Skills

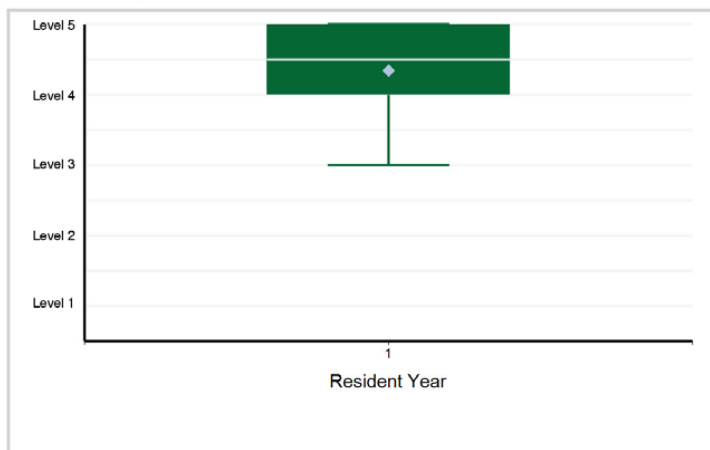

17. Interpersonal and Communication Skills - Communication with Health Care Professionals – Interpersonal Communication Skills

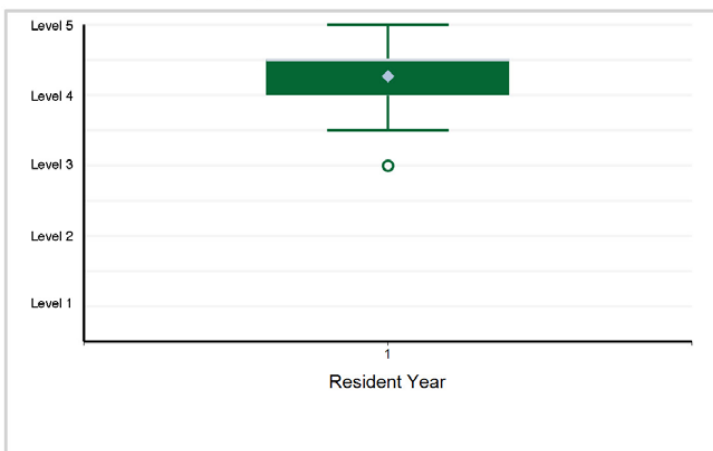

Specialty Box Plot Report - Milestone Evaluation by Resident Year: Year-End 2021-2022

TABLE 23: SPECIALTY: **Family Medicine**

Resident Year	1	2	3	Total Residents*
# of Residents	4,962	4,810	4,573	14,345

*Note: There are 30 residents with an incomplete milestone evaluation that are excluded from the box plots below.

1. Patient Care - Patient Care 1: Care of the Acutely Ill Patient

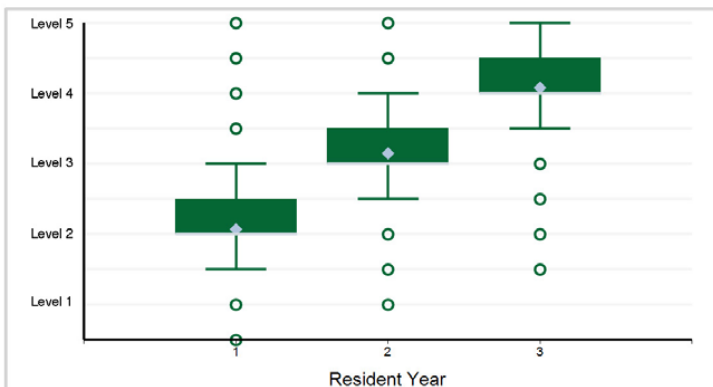

Note: 10 of 14,315 residents have a status of "Not Yet Assessable" and are not included in the analysis.

2. Patient Care - Patient Care 2: Care of Patients with Chronic Illness

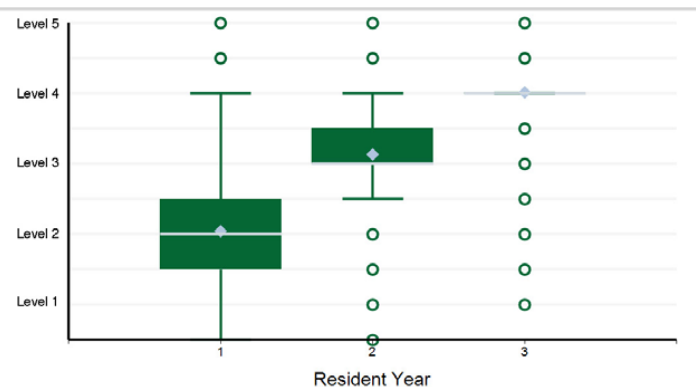

Note: 9 of 14,315 residents have a status of "Not Yet Assessable" and are not included in the analysis.

3. Patient Care - Patient Care 3: Health Promotion and Wellness

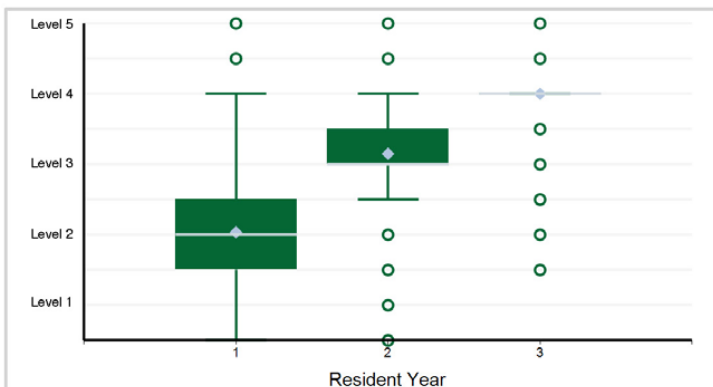

Note: 11 of 14,315 residents have a status of "Not Yet Assessable" and are not included in the analysis.

4. Patient Care - Patient Care 4: Ongoing Care of Patients with Undifferentiated Signs, Symptoms, or Health Concerns

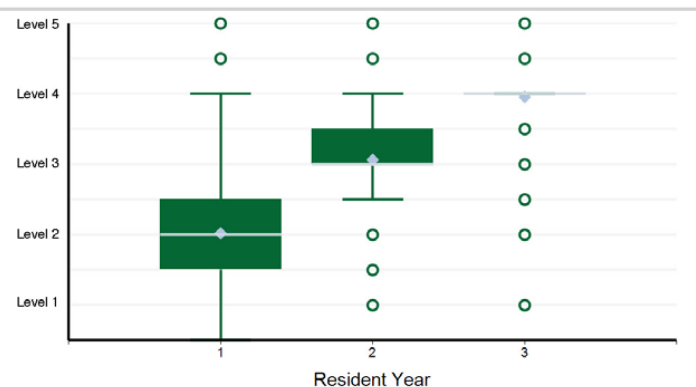

Note: 11 of 14,315 residents have a status of "Not Yet Assessable" and are not included in the analysis.

5. Patient Care - Patient Care 5: Management of Procedural Care

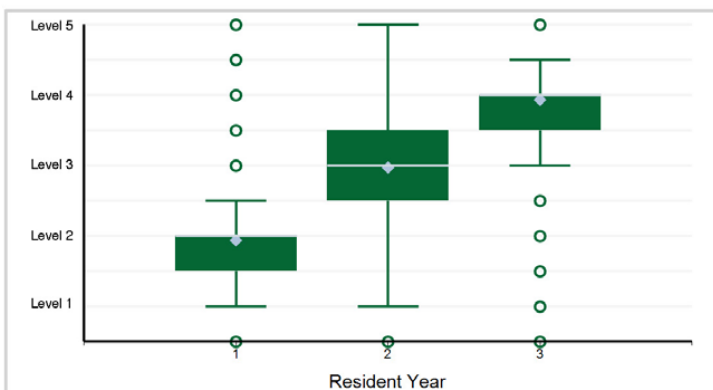

Note: 59 of 14,315 residents have a status of "Not Yet Assessable" and are not included in the analysis.

6. Medical Knowledge - Medical Knowledge 1: Demonstrates Medical Knowledge of Sufficient Breadth and Depth ...

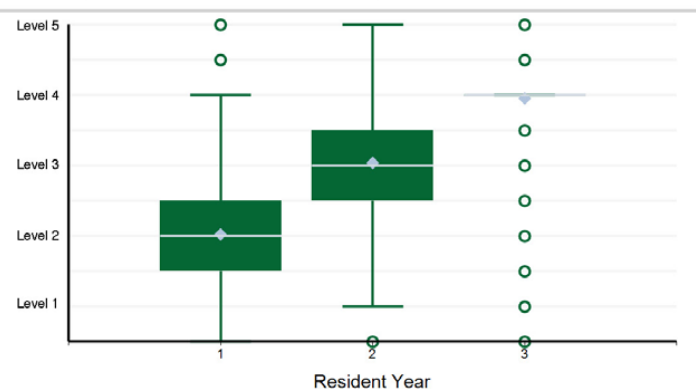

Note: 13 of 14,315 residents have a status of "Not Yet Assessable" and are not included in the analysis.

Specialty Box Plot Report - Milestone Evaluation by Resident Year: Year-End 2021-2022

SPECIALTY: Family Medicine

7. Medical Knowledge - Medical Knowledge 2: Critical Thinking and Decision Making

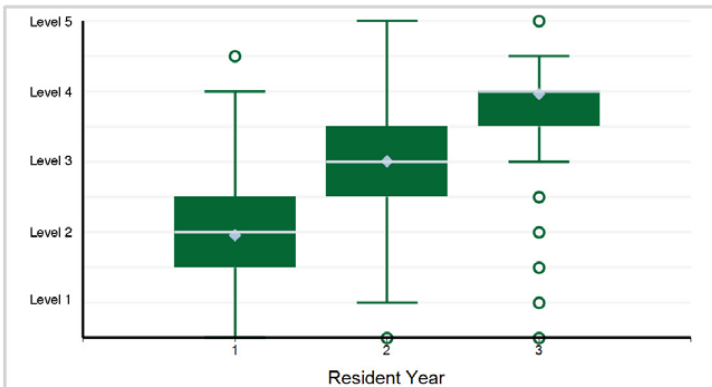

Note: 12 of 14,315 residents have a status of "Not Yet Assessable" and are not included in the analysis.

8. Systems-Based Practice - Systems-Based Practice 1: Patient Safety and Quality Improvement

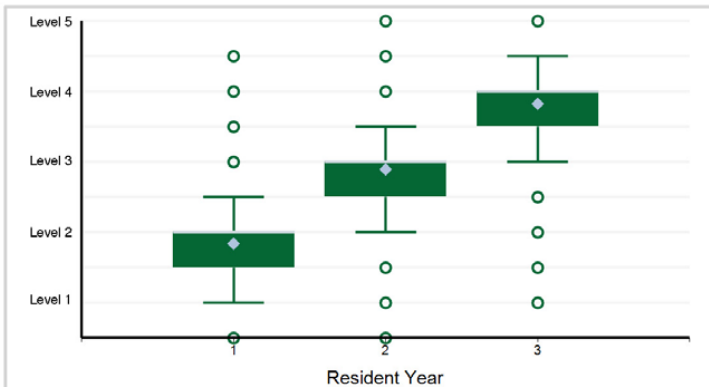

9. Systems-Based Practice - Systems-Based Practice 2: System Navigation for Patient-Centered Care

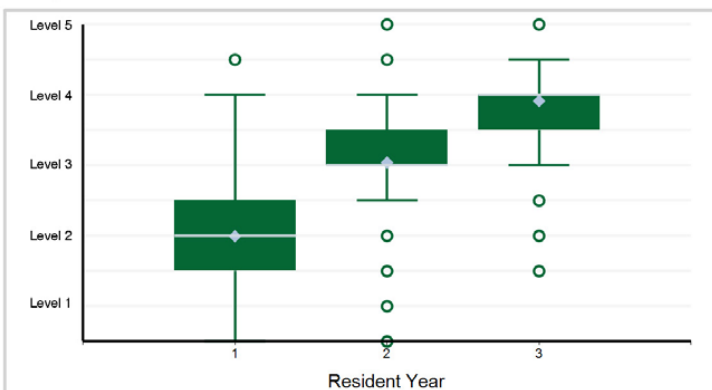

10. Systems-Based Practice - Systems-Based Practice 3: Physician Role in Health Care Systems

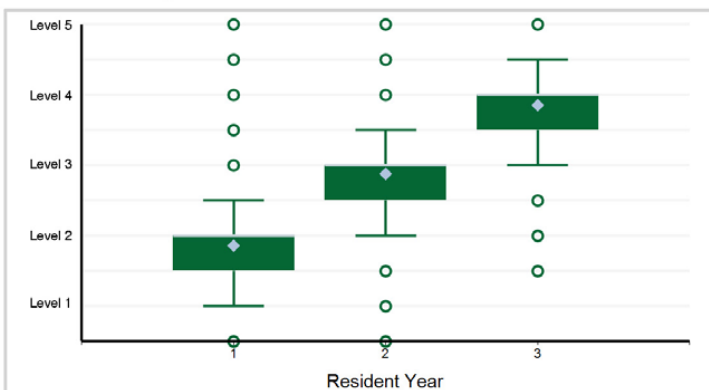

11. Systems-Based Practice - Systems-Based Practice 4: Advocacy

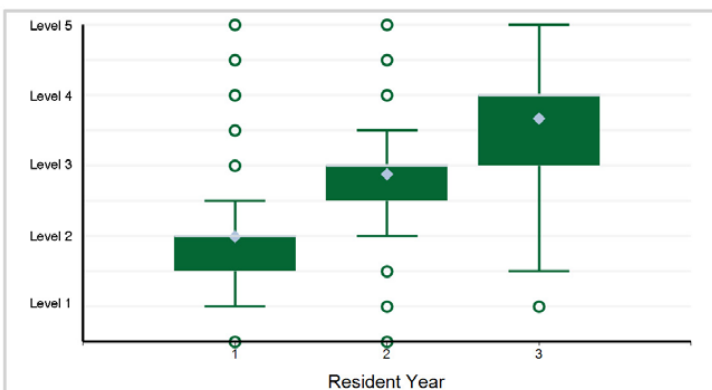

12. Practice-Based Learning and Improvement - Practice-Based Learning and Improvement 1: Evidence-Based and Informed Practice

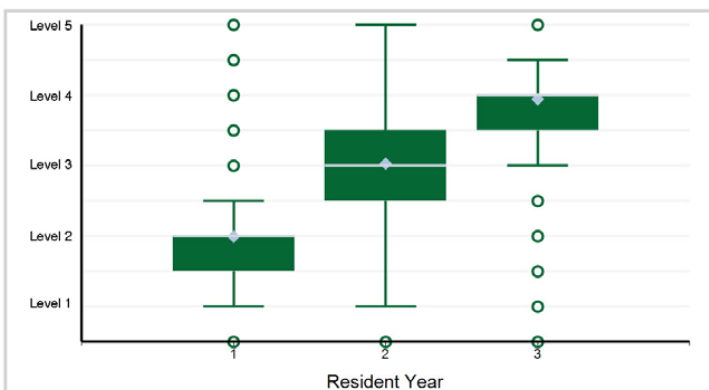

Specialty Box Plot Report - Milestone Evaluation by Resident Year: Year-End 2021-2022

SPECIALTY: Family Medicine

13. Practice-Based Learning and Improvement - Practice-Based Learning and Improvement 2: Reflective Practice and Commitment ...

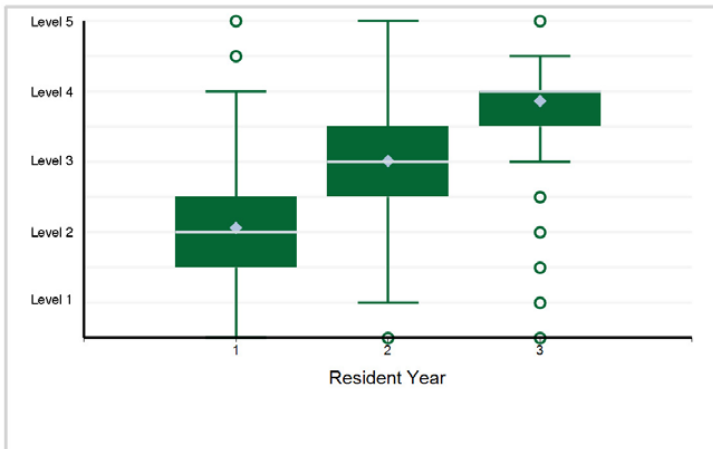

14. Professionalism - Professionalism 1: Professional Behavior and Ethical Principles

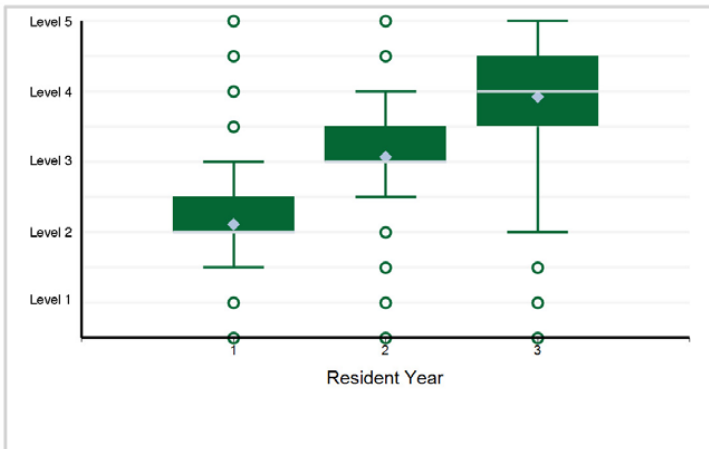

15. Professionalism - Professionalism 2: Accountability/Conscientiousness

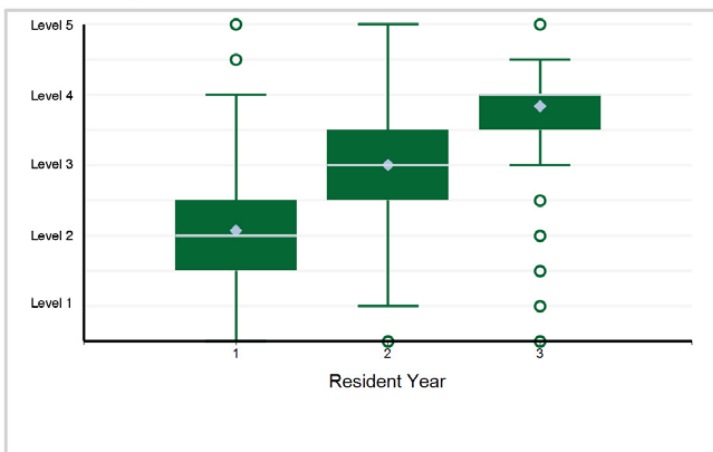

16. Professionalism - Professionalism 3: Self-Awareness and Help-Seeking Behaviors

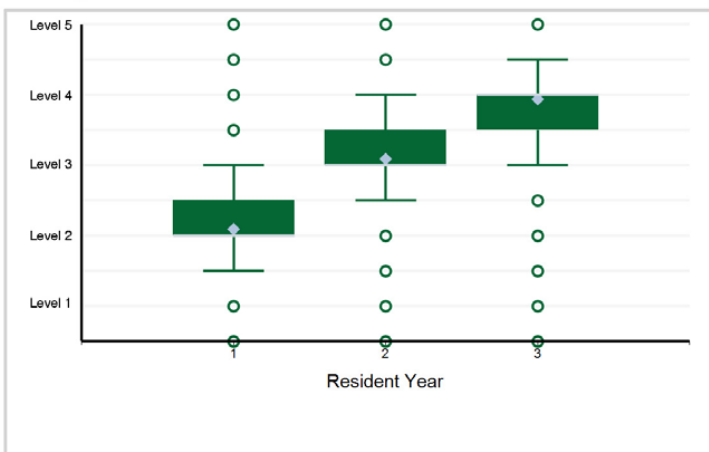

17. Interpersonal and Communication Skills - Interpersonal and Communication Skills 1: Patient- and Family-Centered Communication

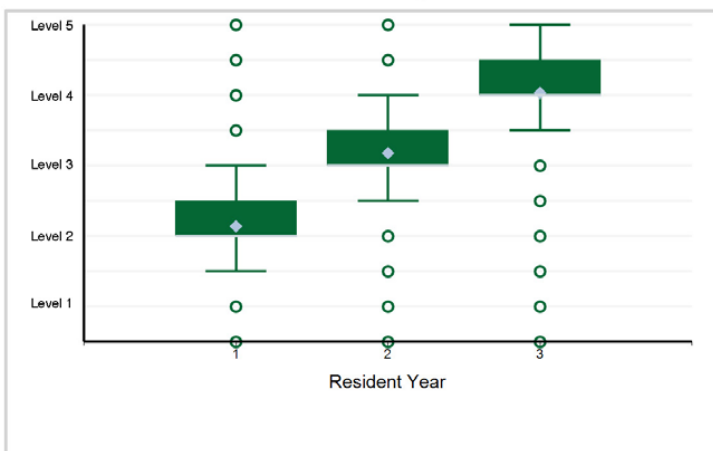

18. Interpersonal and Communication Skills - Interpersonal and Communication Skills 2: Interprofessional and Team Communication

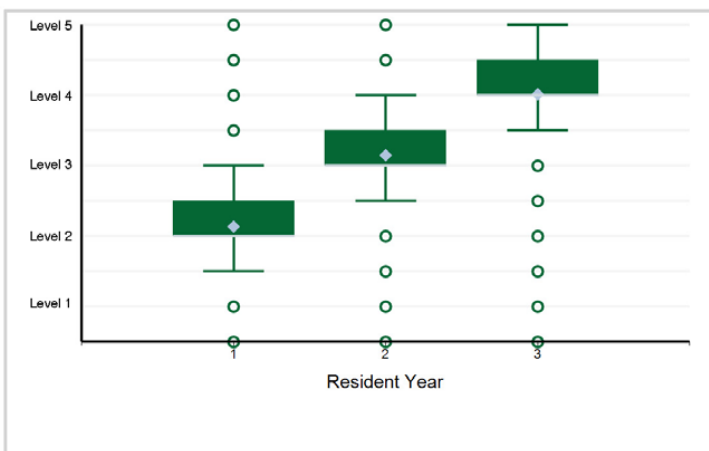

Specialty Box Plot Report - Milestone Evaluation by Resident Year: Year-End 2021-2022

SPECIALTY: **Family Medicine**

19. Interpersonal and Communication Skills - Interpersonal and Communication Skills 3: Communication within Health Care Systems

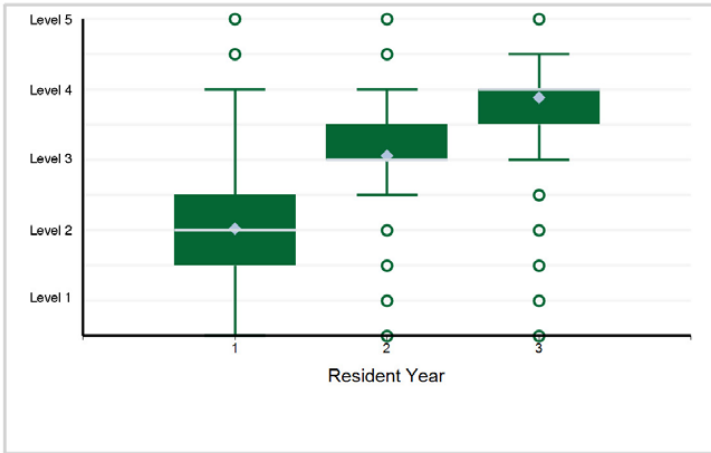

Specialty Box Plot Report - Milestone Evaluation by Resident Year: Year-End 2021-2022

TABLE 24: SUBSPECIALTY: **Clinical Informatics (multidisciplinary, Family Medicine)**

Resident Year	1	2	Total Residents
# of Residents	11	8	19

1. Patient Care - Patient Care 1: Technology Assessment

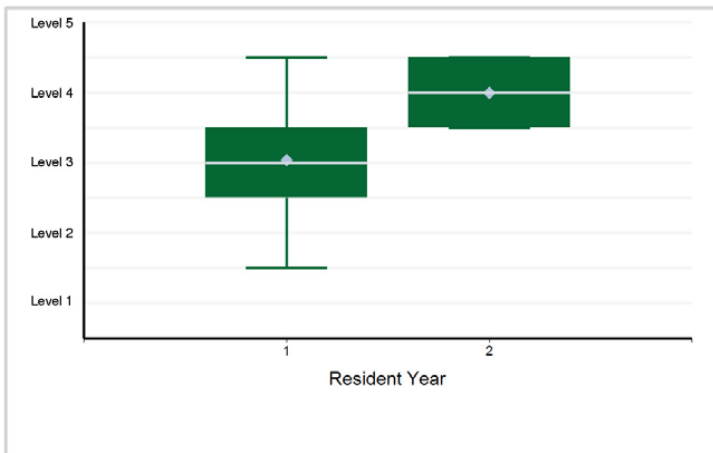

2. Patient Care - Patient Care 2: Clinical Decision Support Systems

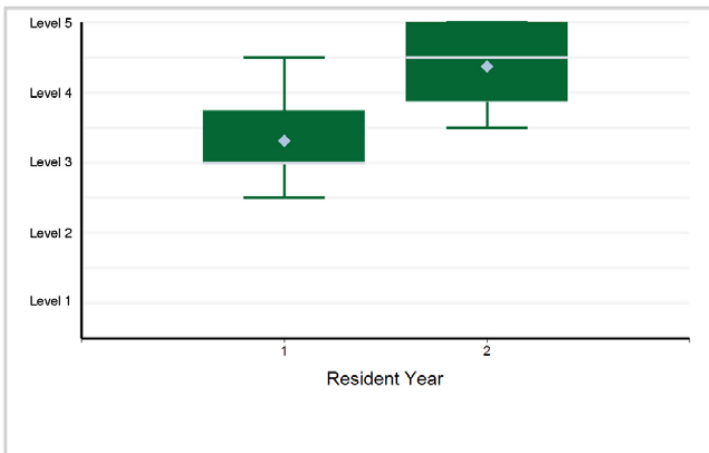

3. Patient Care - Patient Care 3: Impact of Clinical Informatics on Patient Care

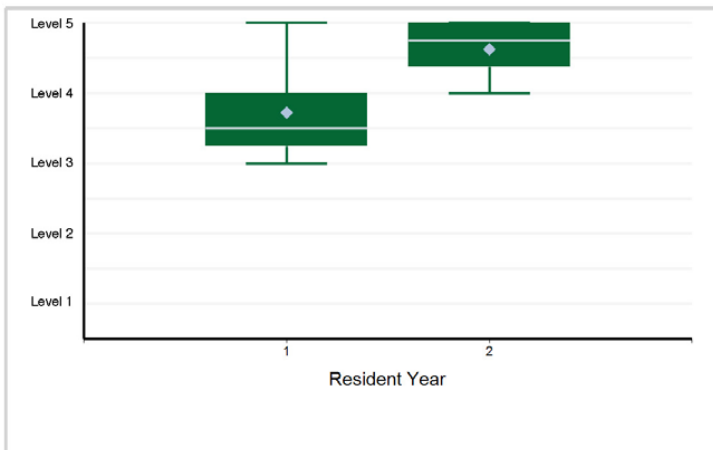

4. Patient Care - Patient Care 4: Project Management

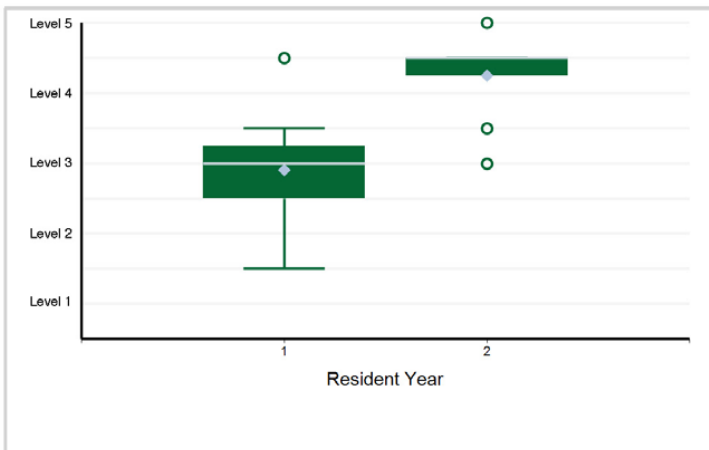

5. Patient Care - Patient Care 5: Information System Lifecycle

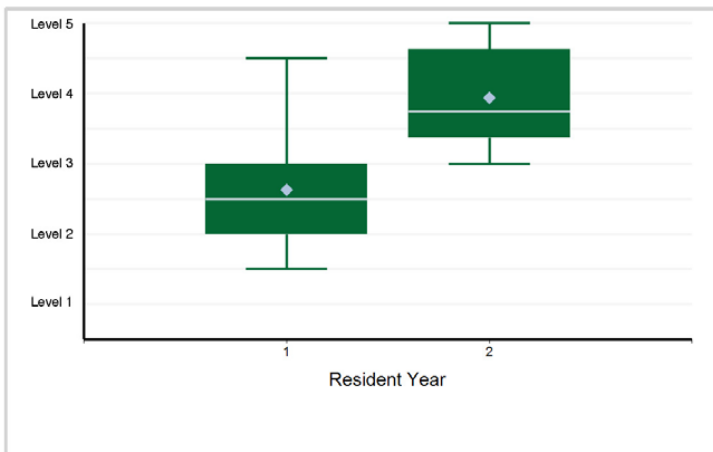

6. Patient Care - Patient Care 6: Assessing User Needs

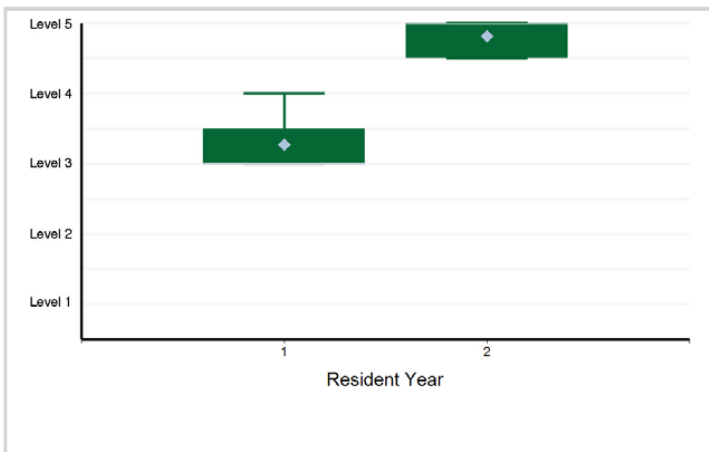

Specialty Box Plot Report - Milestone Evaluation by Resident Year: Year-End 2021-2022

SUBSPECIALTY: Clinical Informatics (multidisciplinary, Family Medicine)

7. Medical Knowledge - Medical Knowledge 1: Clinical Informatics Fundamentals and Programming

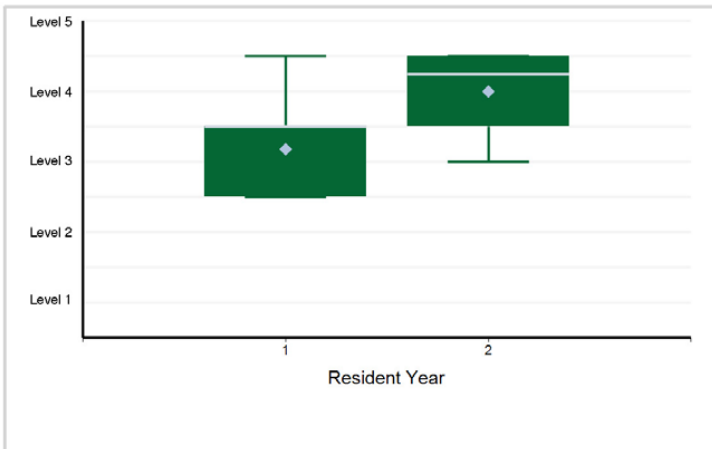

8. Medical Knowledge - Medical Knowledge 2: Leadership and Change Management

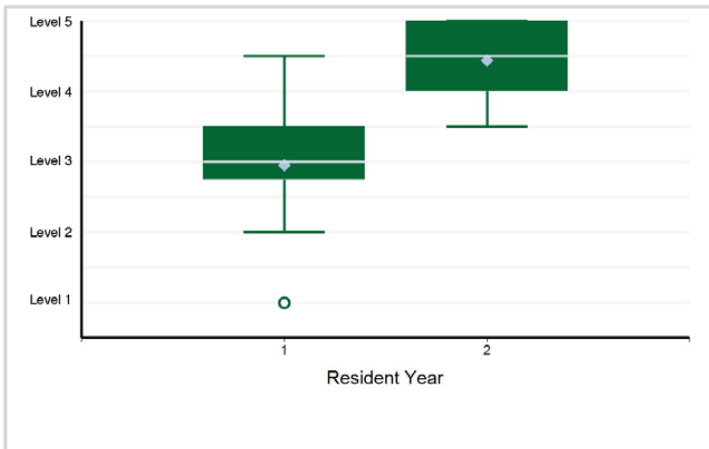

9. Systems-Based Practice - Systems-Based Practice 1: Patient Safety and Unintended Consequences

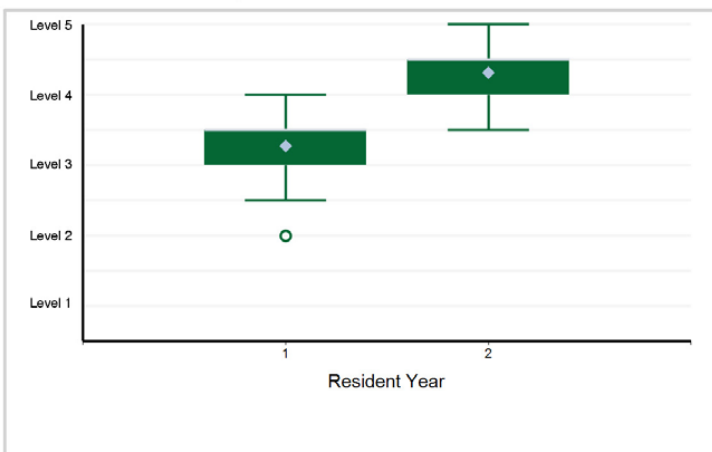

10. Systems-Based Practice - Systems-Based Practice 2: Resource Utilization

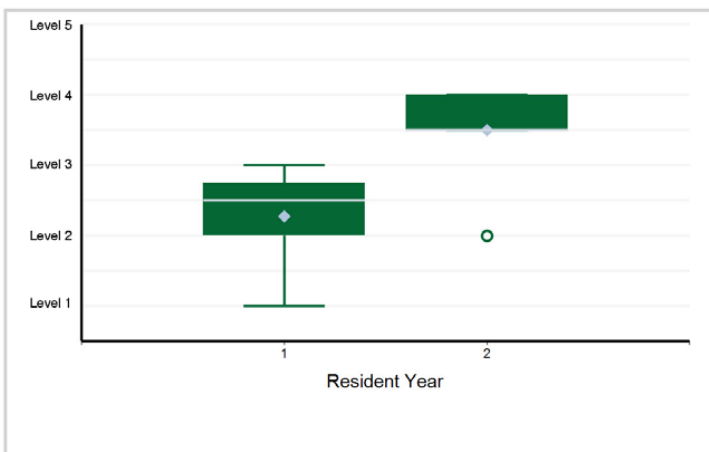

11. Systems-Based Practice - Systems-Based Practice 3: Workflow and Data Warehouse/Repository

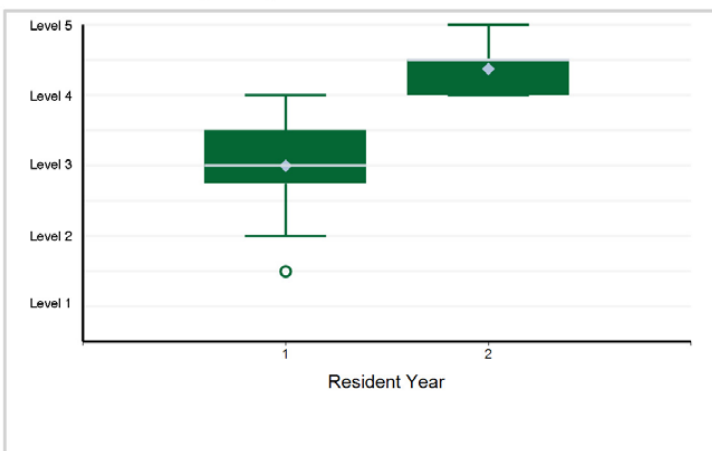

12. Practice-Based Learning and Improvement - Practice-Based Learning and Improvement 1: Recognition of ...

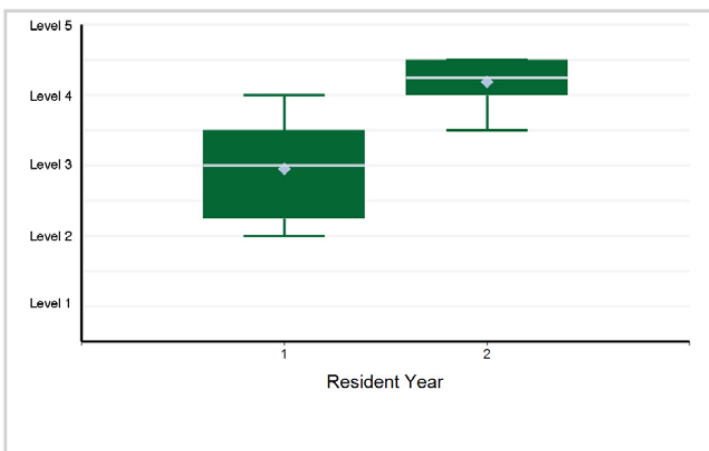

Specialty Box Plot Report - Milestone Evaluation by Resident Year: Year-End 2021-2022

SUBSPECIALTY: Clinical Informatics (multidisciplinary, Family Medicine)

13. Practice-Based Learning and Improvement - Practice-Based Learning and Improvement 2: Scholarly Activity ...

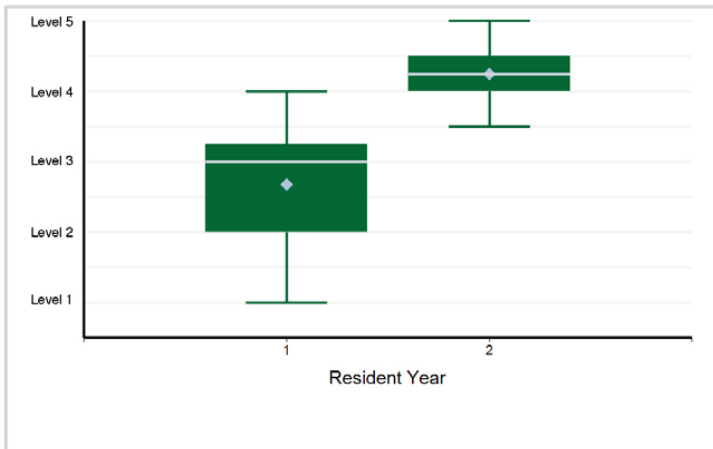

14. Professionalism - Professionalism 1: Professionalism — Demonstrates honesty, integrity, and ethical behavior

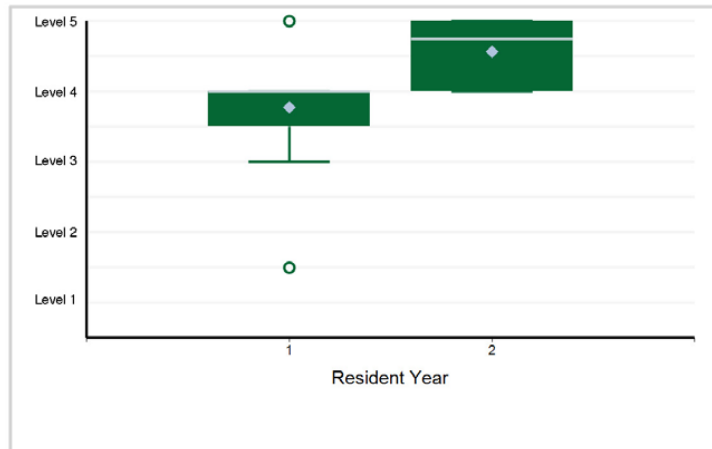

15. Professionalism - Professionalism 2: Professionalism — Demonstrates responsibility and follow-through on tasks

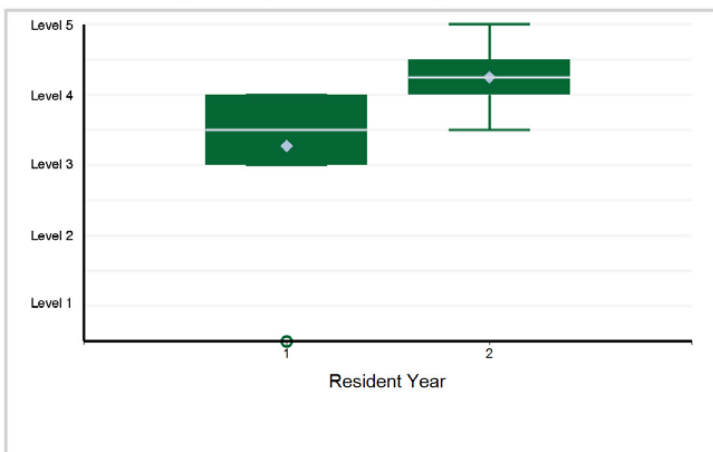

16. Professionalism - Professionalism 3: Professionalism — Gives and receives feedback

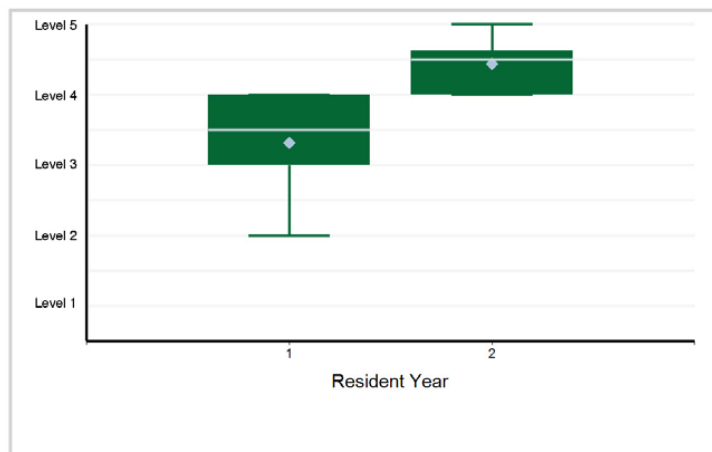

17. Professionalism - Professionalism 4: Professionalism — Demonstrates responsiveness and sensitivity to ...

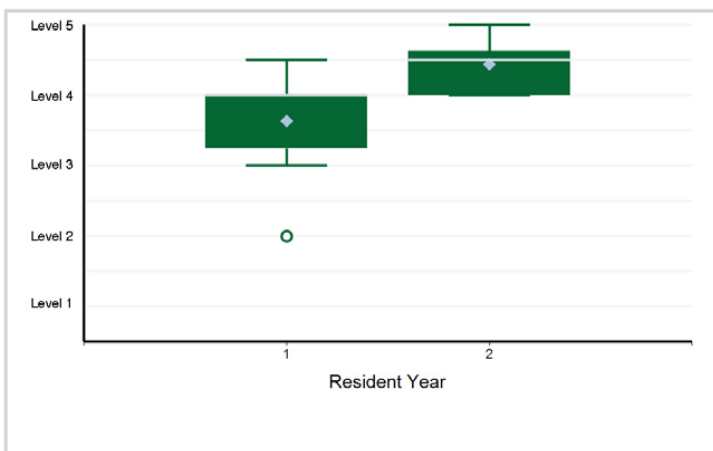

18. Professionalism - Professionalism 5: Professionalism — Understands and practices information security and privacy

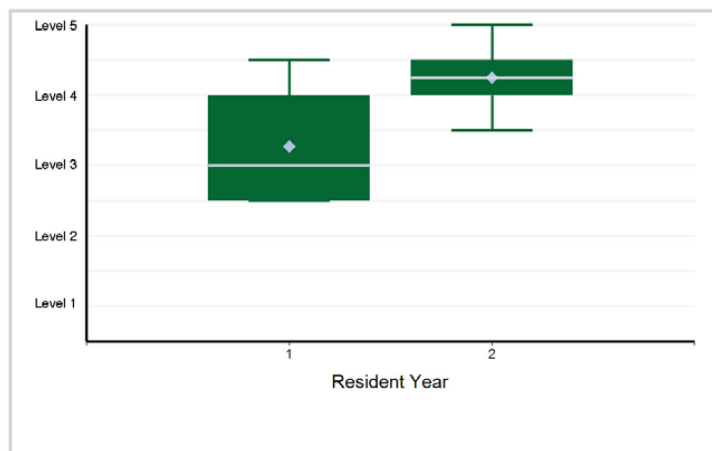

Specialty Box Plot Report - Milestone Evaluation by Resident Year: Year-End 2021-2022

SUBSPECIALTY: **Clinical Informatics (multidisciplinary, Family Medicine)**

19. Interpersonal and Communication Skills - Interpersonal and Communication Skills 1: Effective Communications ...

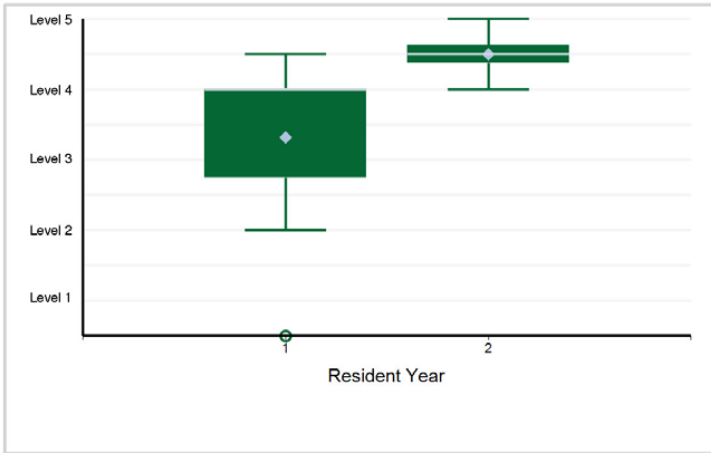

20. Interpersonal and Communication Skills - Interpersonal and Communication Skills 2: Communication with Patients and Families

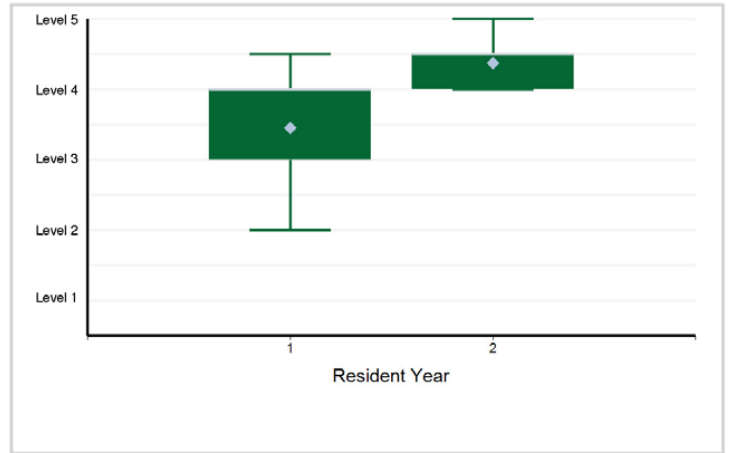

Specialty Box Plot Report - Milestone Evaluation by Resident Year: Year-End 2021-2022

TABLE 25: SUBSPECIALTY: **Geriatric Medicine (multidisciplinary, Family Medicine)**

Resident Year	1	Total Residents
# of Residents	50	50

1. Patient Care - Patient Care 1: Comprehensive Geriatric Assessment

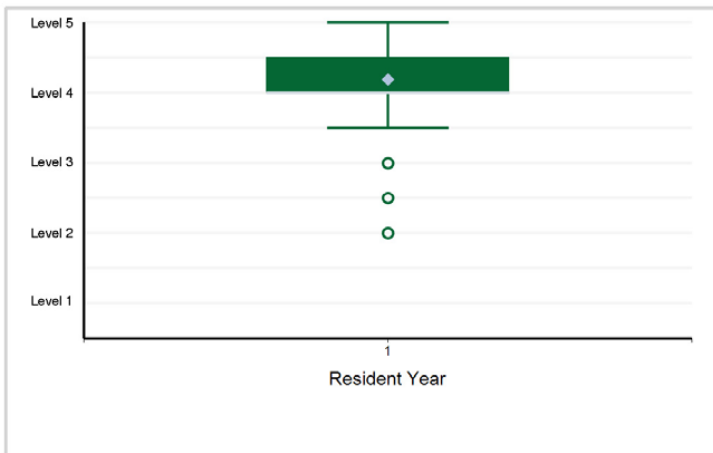

2. Patient Care - Patient Care 2: Patient and Family/Caregiver Support

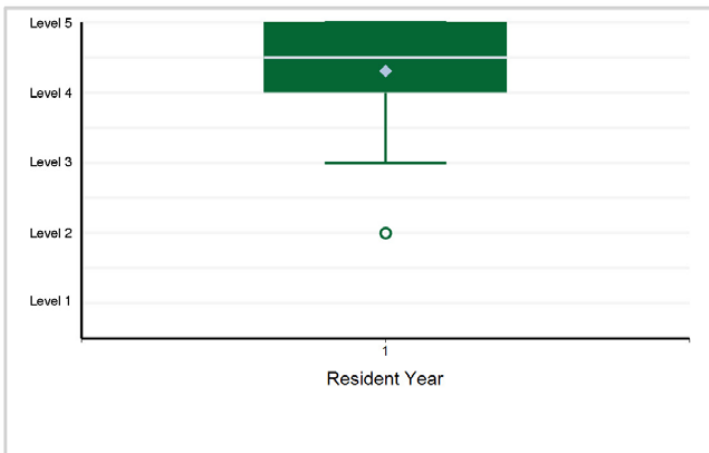

3. Patient Care - Patient Care 3: Assessing and Optimizing of Pharmacotherapy

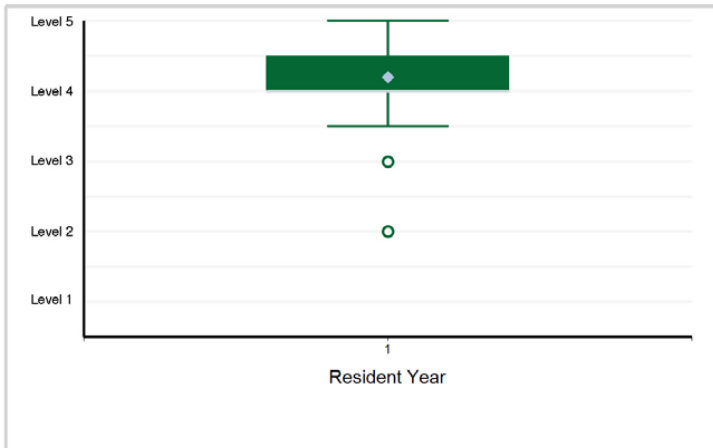

4. Patient Care - Patient Care 4: Assessing and Optimizing Physical and Cognitive Function

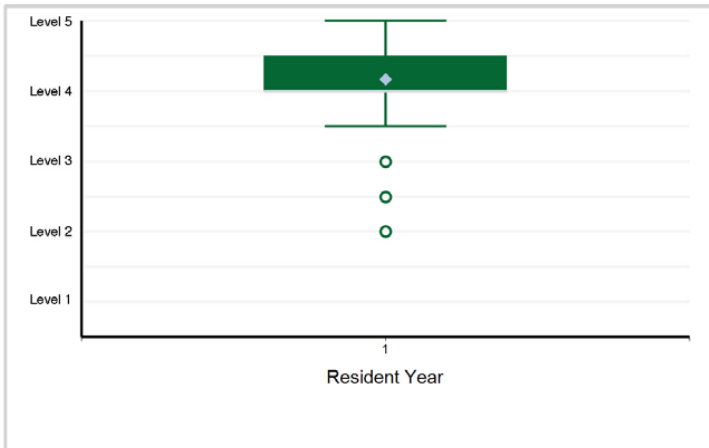

5. Patient Care - Patient Care 5: Framing Clinical Management Decisions within the Context of Prognosis

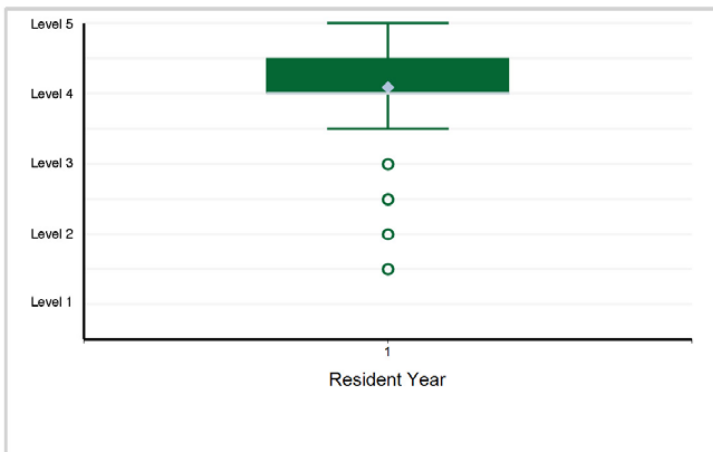

6. Patient Care - Patient Care 6: Consultative Care

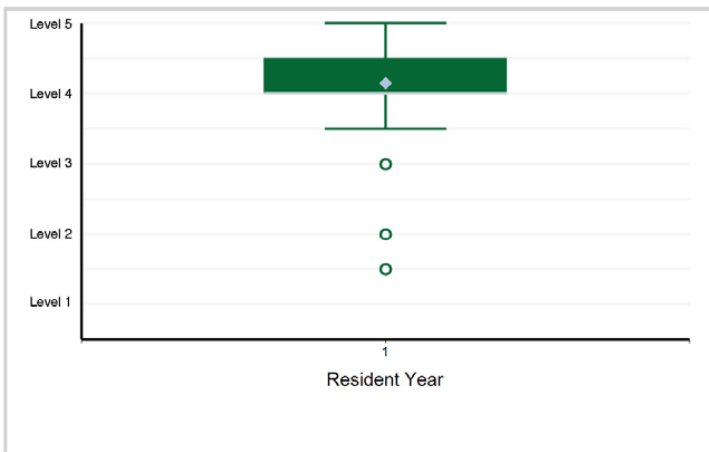

Specialty Box Plot Report - Milestone Evaluation by Resident Year: Year-End 2021-2022

SUBSPECIALTY: Geriatric Medicine (multidisciplinary, Family Medicine)

7. Medical Knowledge - Medical Knowledge 1: Geriatric Syndromes

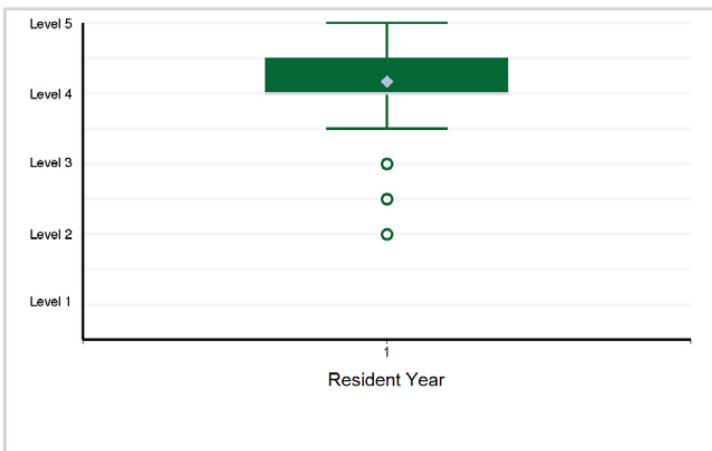

8. Medical Knowledge - Medical Knowledge 2: Principles of Aging

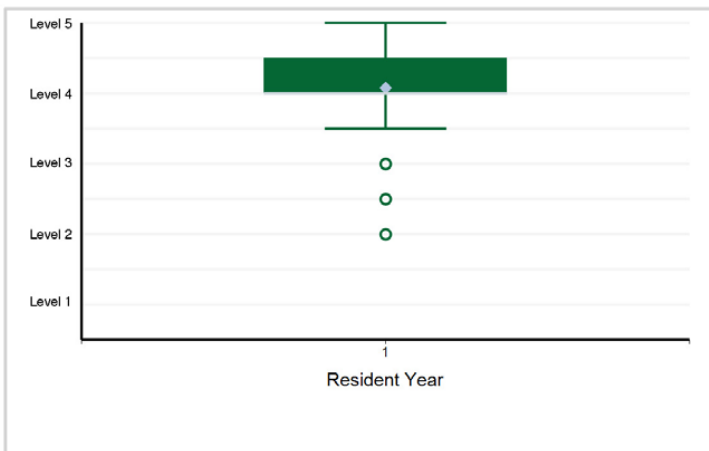

9. Systems-Based Practice - Systems-Based Practice 1: Patient Safety and Quality Improvement



10. Systems-Based Practice - Systems-Based Practice 2: System Navigation for Patient-Centered Care

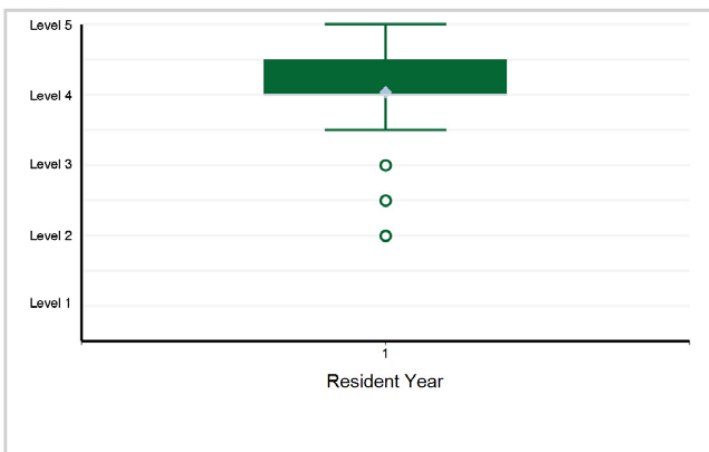

11. Systems-Based Practice - Systems-Based Practice 3: Physician Role in Health Care Systems

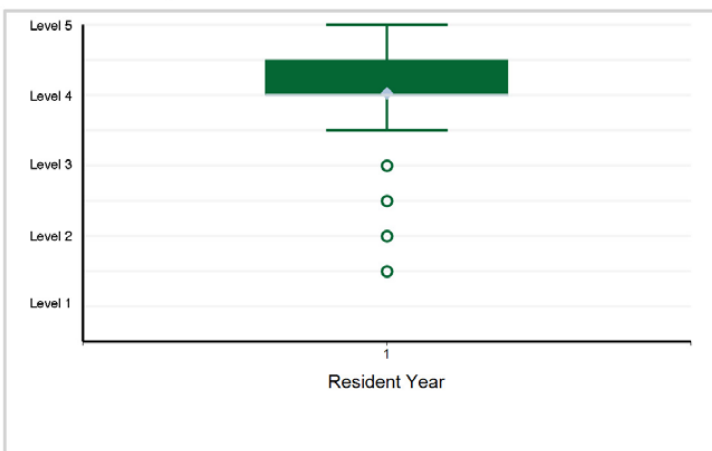

12. Systems-Based Practice - Systems-Based Practice 4: Models and Systems of Care

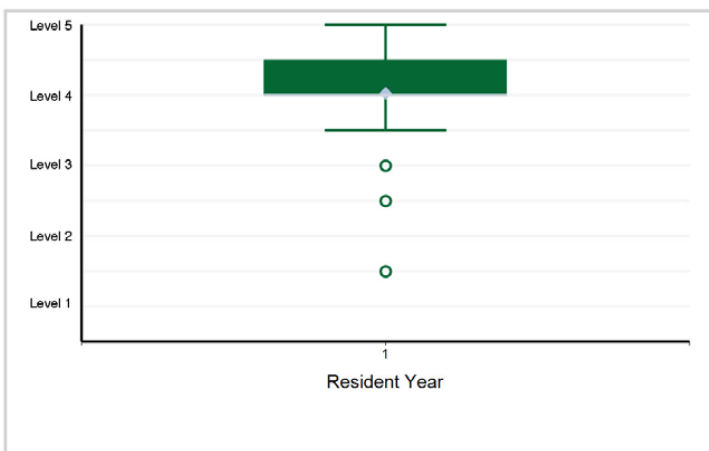

Specialty Box Plot Report - Milestone Evaluation by Resident Year: Year-End 2021-2022

SUBSPECIALTY: Geriatric Medicine (multidisciplinary, Family Medicine)

13. Practice-Based Learning and Improvement - Practice-Based Learning and Improvement 1: Evidence-Based and Informed Practice

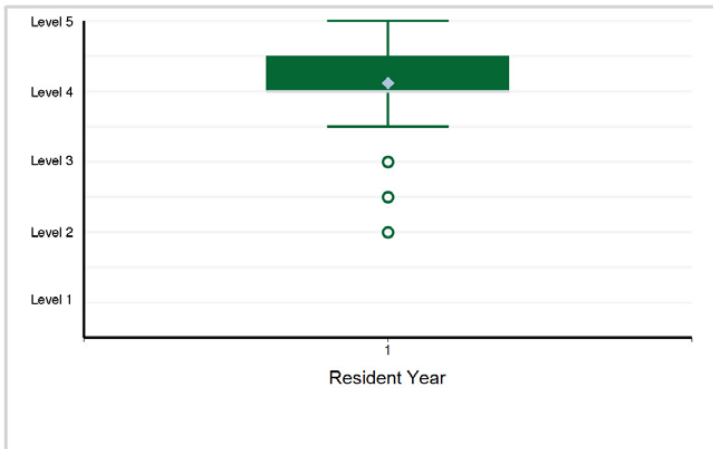

14. Practice-Based Learning and Improvement - Practice-Based Learning and Improvement 2: Reflective Practice and Commitment ...

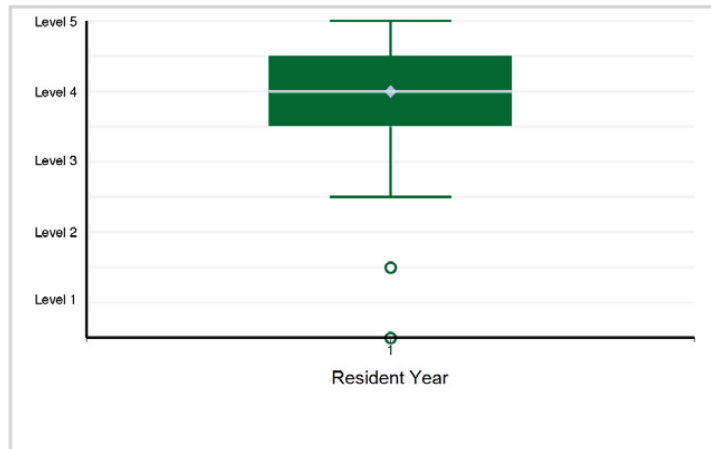

15. Professionalism - Professionalism 1: Professional Behavior

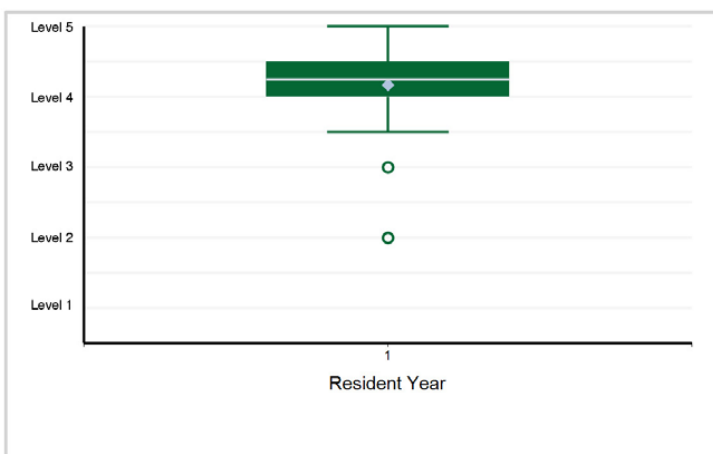

16. Professionalism - Professionalism 2: Ethical Principles



17. Professionalism - Professionalism 3: Accountability/Conscientiousness

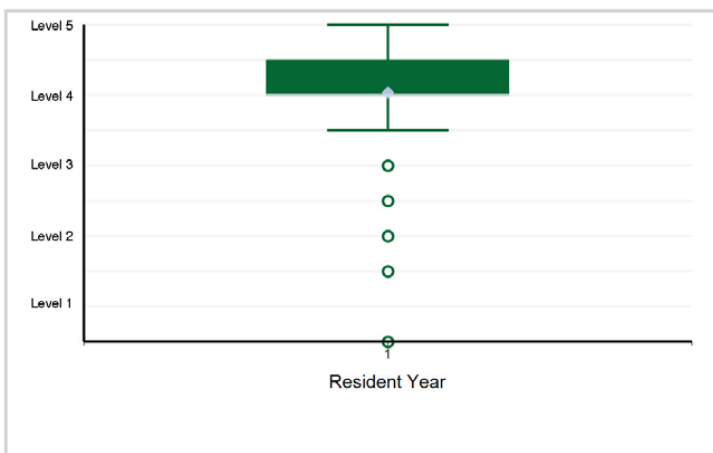

18. Professionalism - Professionalism 4: Well-Being



Specialty Box Plot Report - Milestone Evaluation by Resident Year: Year-End 2021-2022

SUBSPECIALTY: **Geriatric Medicine (multidisciplinary, Family Medicine)**

19. Interpersonal and Communication Skills - Interpersonal and Communication Skills 1: Patient- and Family-Centered Communication

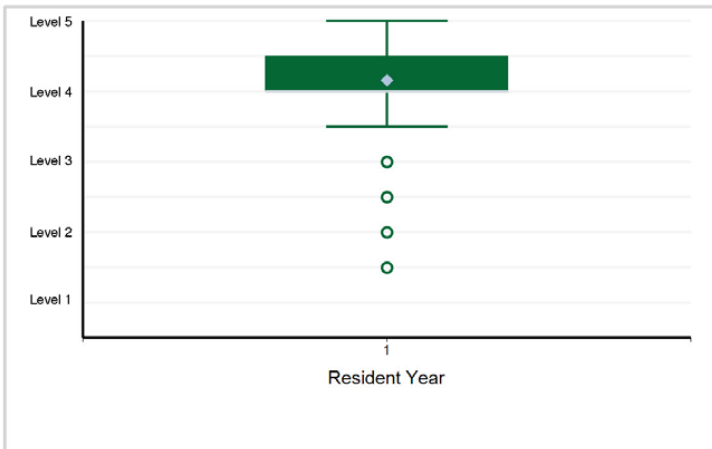

20. Interpersonal and Communication Skills - Interpersonal and Communication Skills 2: Interprofessional and Team Communication

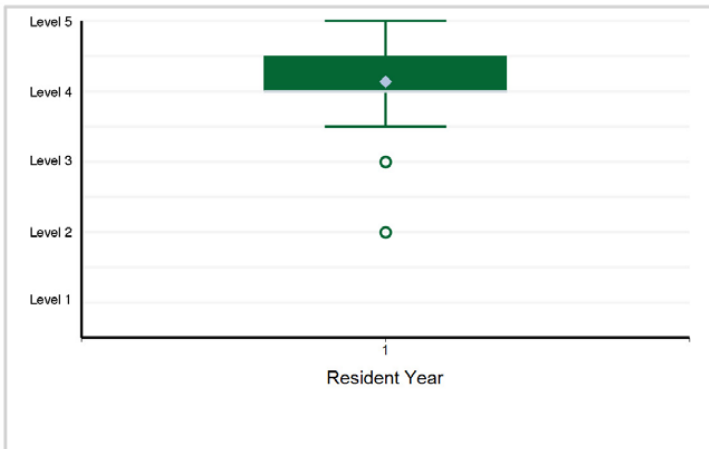

21. Interpersonal and Communication Skills - Interpersonal and Communication Skills 3: Communication within Health Care Systems

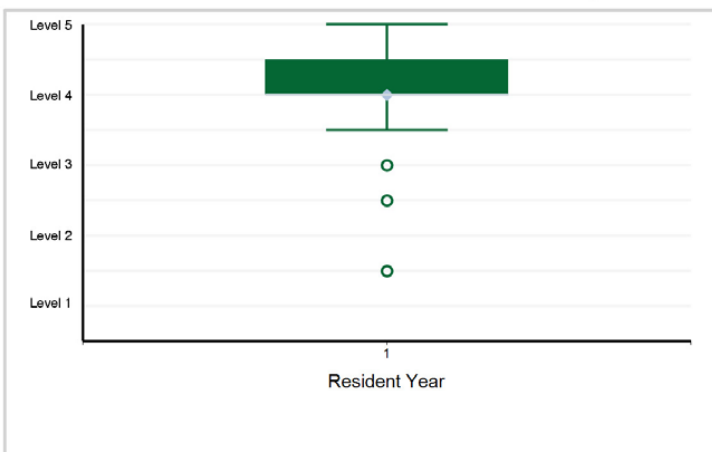

22. Interpersonal and Communication Skills - Interpersonal and Communication Skills 4: Complex Communication around Serious ...

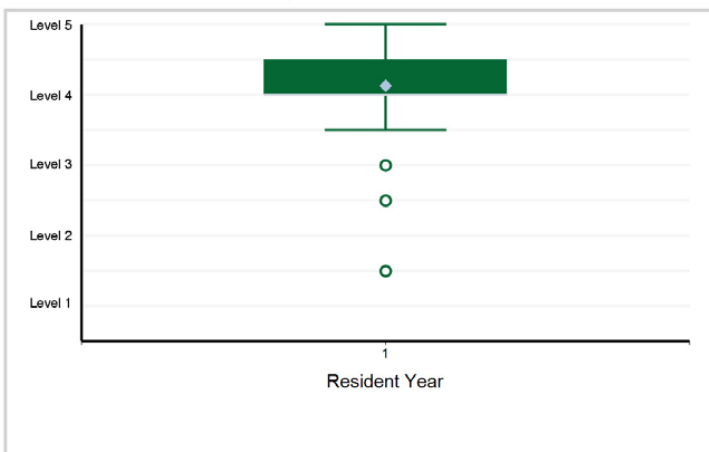

Specialty Box Plot Report - Milestone Evaluation by Resident Year: Year-End 2021-2022

TABLE 26: SUBSPECIALTY: **Hospice and Palliative Medicine (multidisciplinary, Family Medicine)**

Resident Year	1	Total Residents
# of Residents	459	459

1. Patient Care - Patient Care 1: Comprehensive Whole Patient Assessment

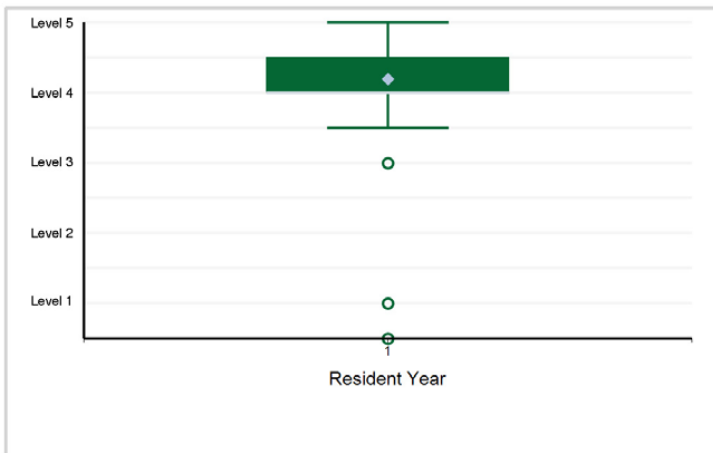

2. Patient Care - Patient Care 2: Addressing Suffering and Distress

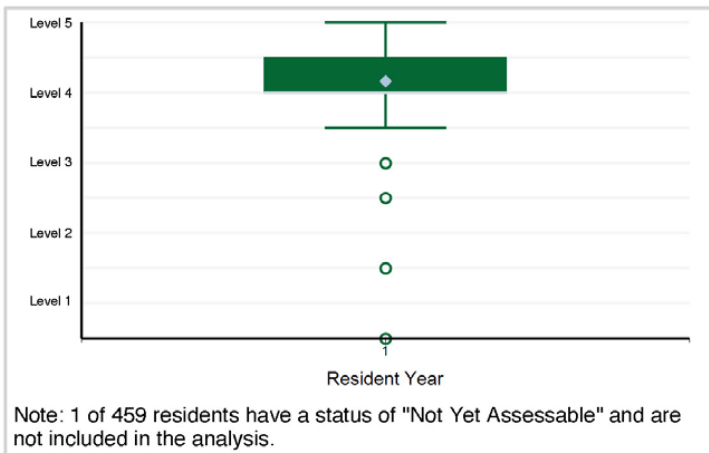

3. Patient Care - Patient Care 3: Withholding and/or Withdrawal of Life-Sustaining Therapies (LST)

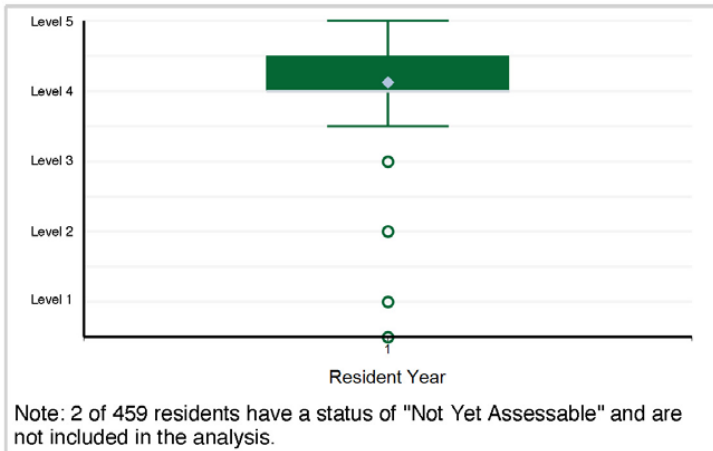

4. Patient Care - Patient Care 4: Care of the Imminently Dying

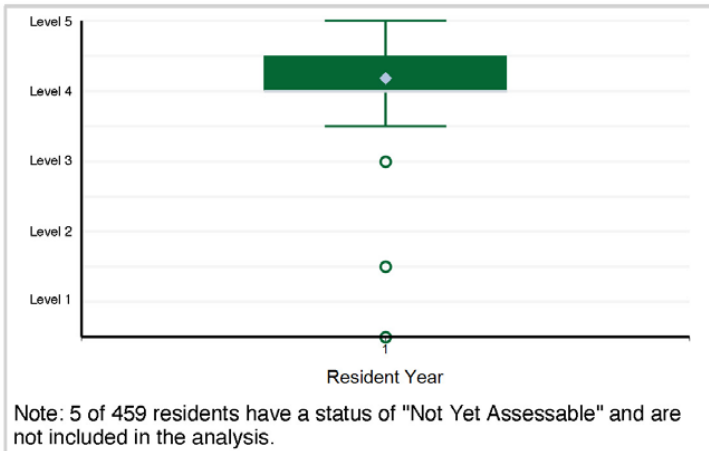

5. Patient Care - The fellow is demonstrating satisfactory development of the knowledge, skill, and attitudes/behaviors ...

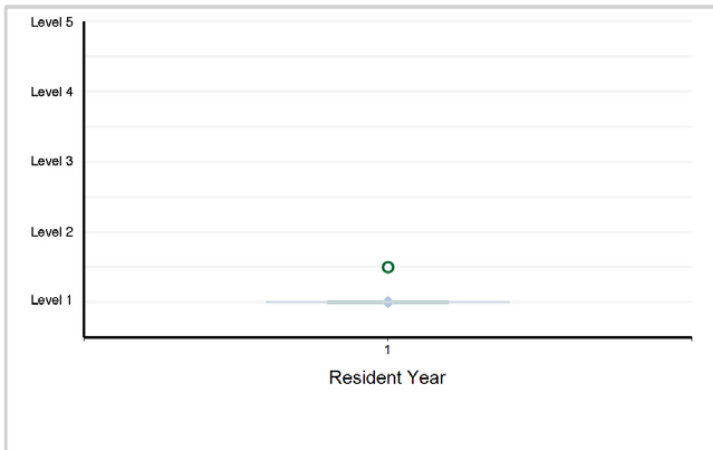

6. Medical Knowledge - Medical Knowledge 1: Disease Trajectories and Formulation of Prognosis in Serious Illness

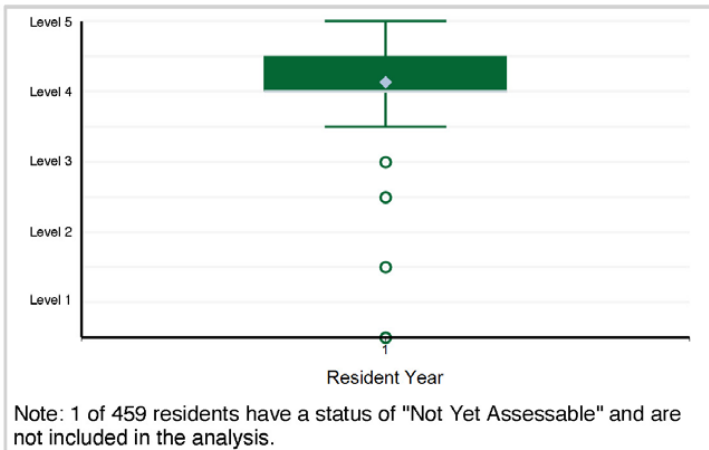

Specialty Box Plot Report - Milestone Evaluation by Resident Year: Year-End 2021-2022

SUBSPECIALTY: Hospice and Palliative Medicine (multidisciplinary, Family Medicine)

7. Medical Knowledge - Medical Knowledge 2: Palliative Management of Pain Symptoms

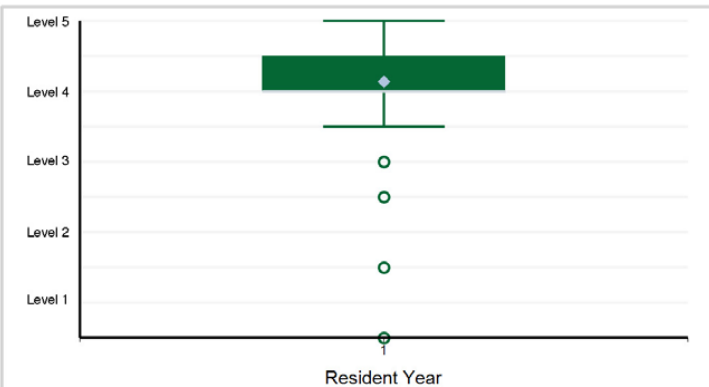

Note: 1 of 459 residents have a status of "Not Yet Assessable" and are not included in the analysis.

8. Medical Knowledge - Medical Knowledge 3: Palliative Management of Non-Pain Symptoms

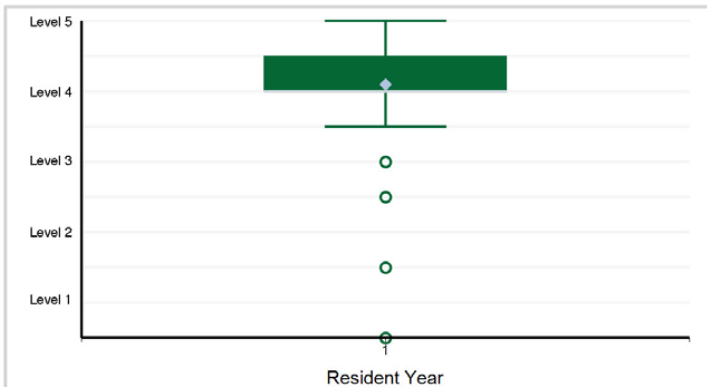

Note: 1 of 459 residents have a status of "Not Yet Assessable" and are not included in the analysis.

9. Medical Knowledge - The fellow is demonstrating satisfactory development of the knowledge, skill, and ...



10. Systems-Based Practice - Systems-Based Practice 1: Patient Safety and Quality Improvement

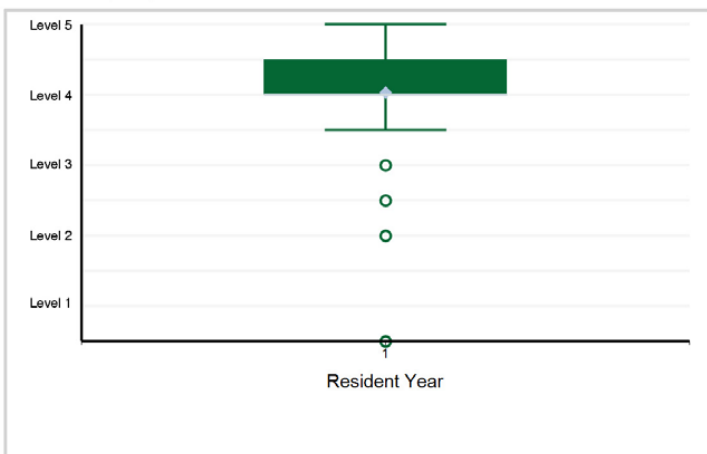

11. Systems-Based Practice - Systems-Based Practice 2: System Navigation for Patient-Centered Care

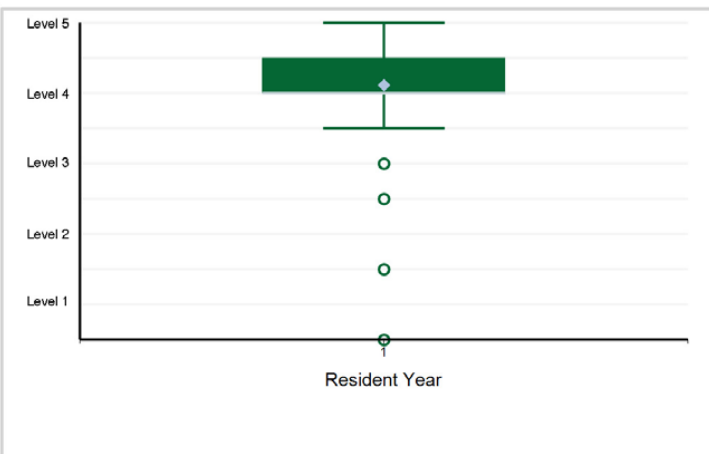

12. Systems-Based Practice - Systems-Based Practice 3: Physician Role within Health Care Systems

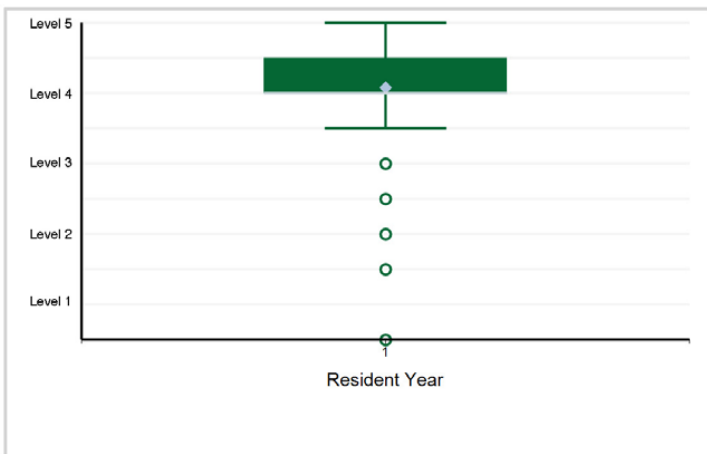

Specialty Box Plot Report - Milestone Evaluation by Resident Year: Year-End 2021-2022

SUBSPECIALTY: Hospice and Palliative Medicine (multidisciplinary, Family Medicine)

13. Systems-Based Practice - Systems-Based Practice 4: Hospice

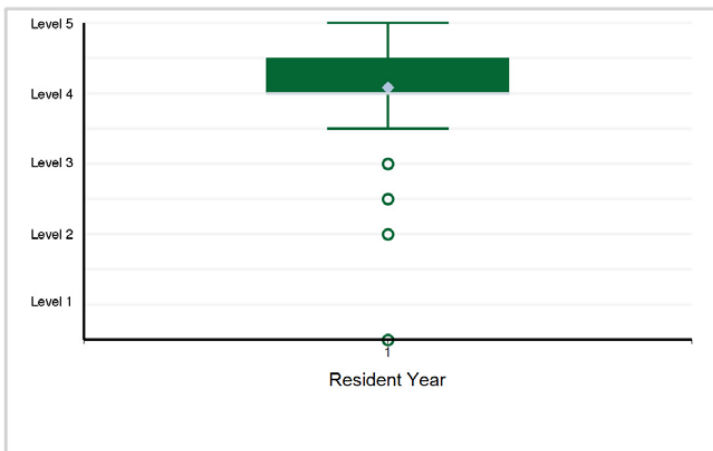

14. Systems-Based Practice - The fellow is demonstrating satisfactory development of the knowledge, skill, ...

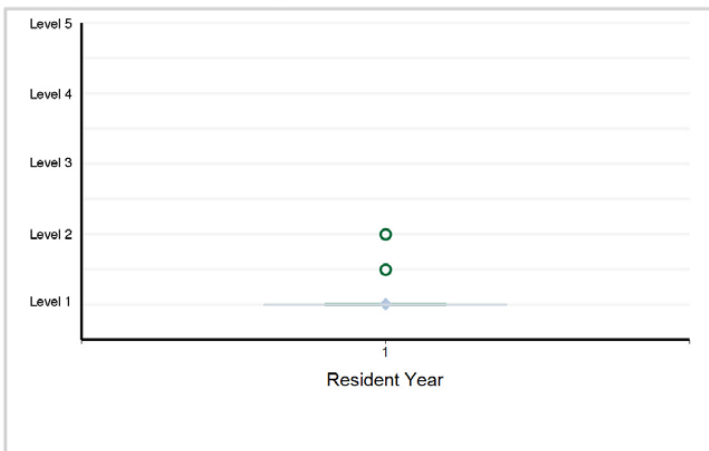

15. Practice-Based Learning and Improvement - Practice-Based Learning and Improvement 1: Evidence-Based and Informed Practice



16. Practice-Based Learning and Improvement - Practice-Based Learning and Improvement 2: Reflective Practice and Commitment ...

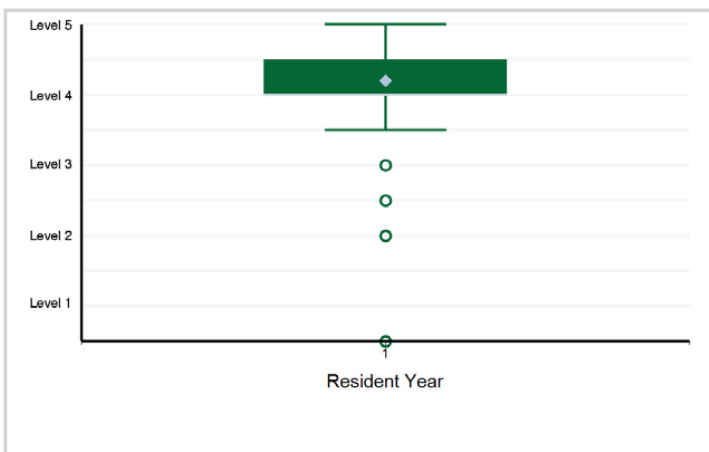

17. Practice-Based Learning and Improvement - The fellow is demonstrating satisfactory development of the knowledge, skill, ...

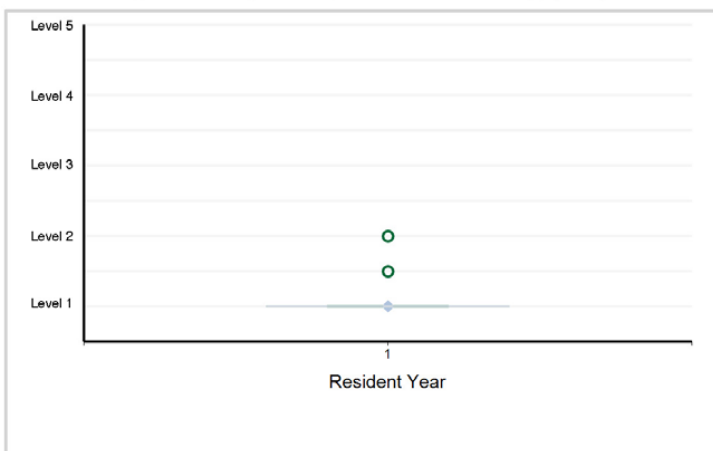

18. Professionalism - Professionalism 1: Professional Behavior and Ethical Principles

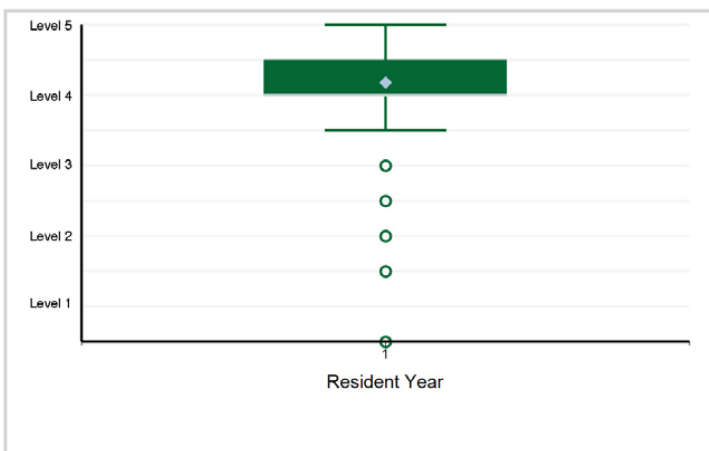

Specialty Box Plot Report - Milestone Evaluation by Resident Year: Year-End 2021-2022

SUBSPECIALTY: Hospice and Palliative Medicine (multidisciplinary, Family Medicine)

19. Professionalism - Professionalism 2: Accountability/Conscientiousness

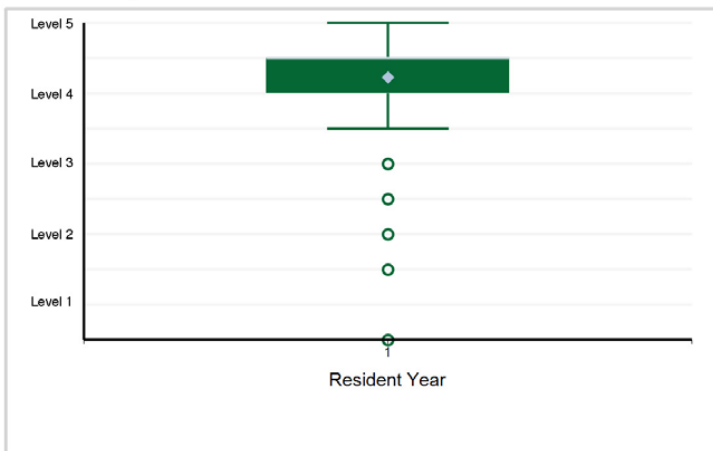

20. Professionalism - Professionalism 3: Self-Awareness and Help Seeking

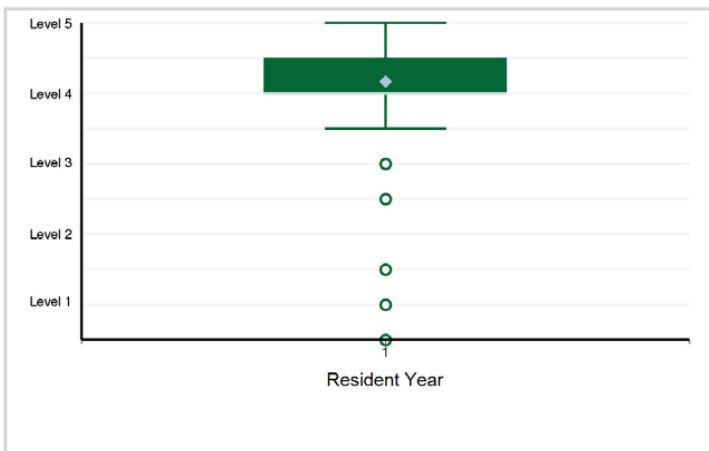

21. Professionalism - The fellow is demonstrating satisfactory development of the knowledge, skill, and attitudes/behaviors ...

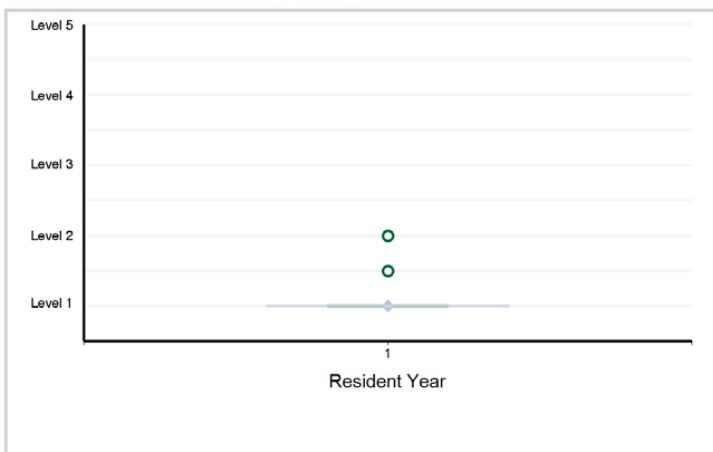

22. Interpersonal and Communication Skills - Interpersonal and Communication Skills 1: Patient- and Family-Centered Communication

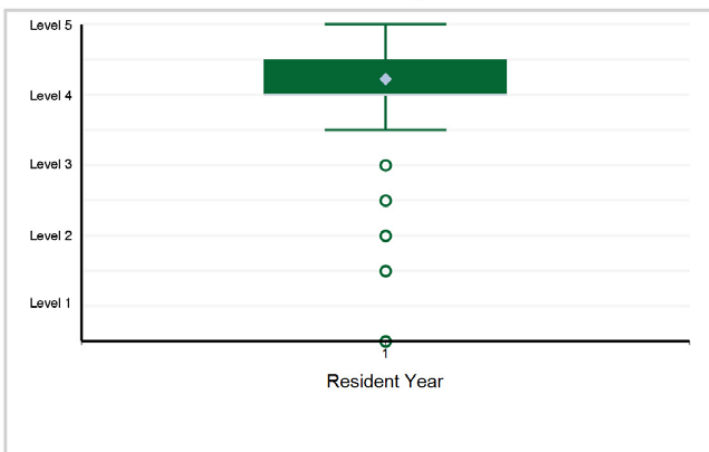

23. Interpersonal and Communication Skills - Interpersonal and Communication Skills 2: Interprofessional and Team Communication

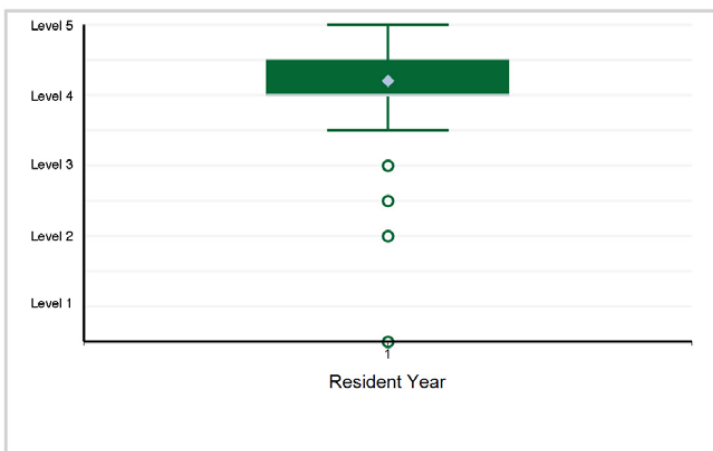

24. Interpersonal and Communication Skills - Interpersonal and Communication Skills 3: Communication with Health Care Systems

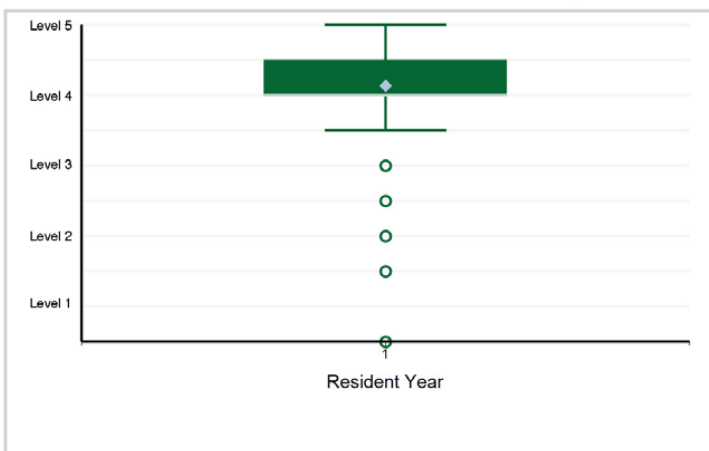

Specialty Box Plot Report - Milestone Evaluation by Resident Year: Year-End 2021-2022

SUBSPECIALTY: **Hospice and Palliative Medicine (multidisciplinary, Family Medicine)**

25. Interpersonal and Communication Skills - Interpersonal and Communication Skills 4: Complex Communication Around Serious ...

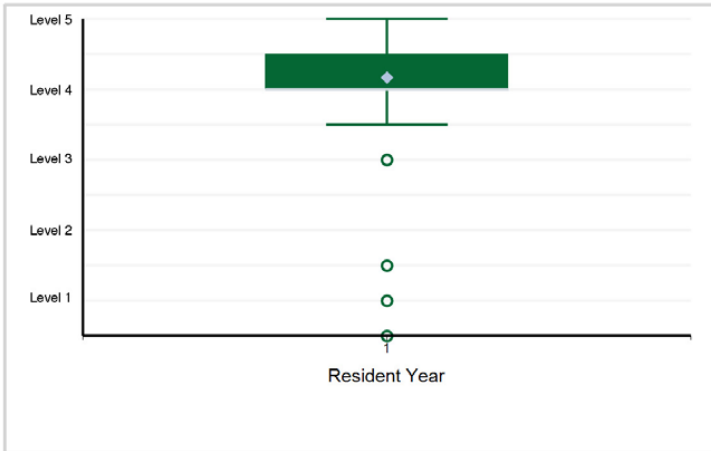

26. Interpersonal and Communication Skills - The fellow is demonstrating satisfactory development of the ...

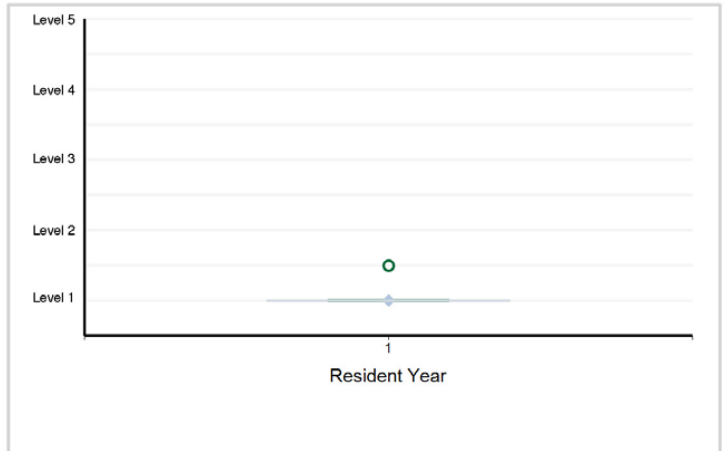

Specialty Box Plot Report - Milestone Evaluation by Resident Year: Year-End 2021-2022

TABLE 27: SUBSPECIALTY: **Sports Medicine (multidisciplinary, Family Medicine)**

Resident Year	1	Total Residents
# of Residents	284	284

1. Patient Care - History and Physical Examination: Medical and Musculoskeletal — Patient Care 1

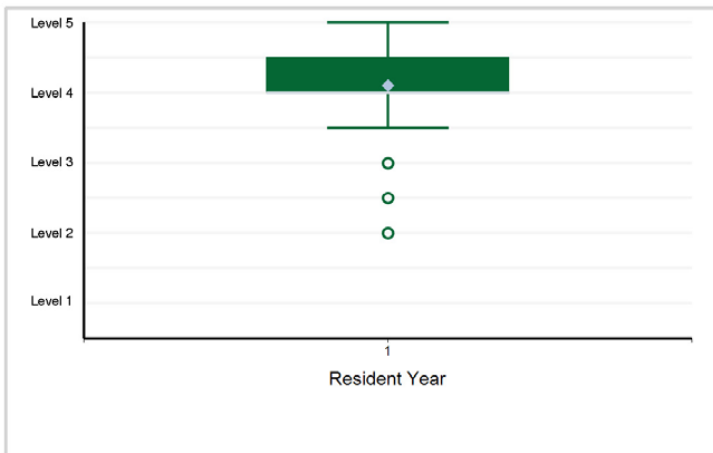

2. Patient Care - Medical Management: Differential Diagnosis, Diagnostic Testing, Interpretation of Data ...

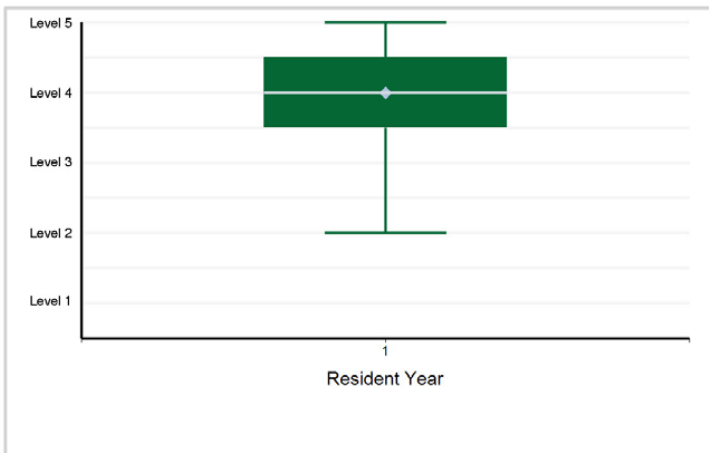

3. Patient Care - Team Coverage and Athletic Care: Coverage of Sporting Events, Pre-participation Physical ...

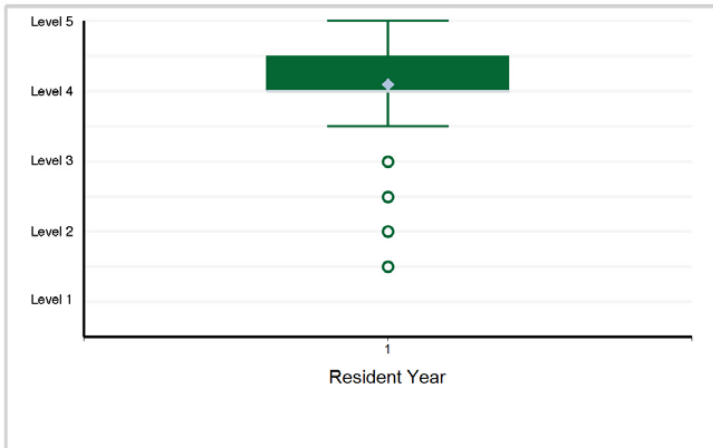

4. Medical Knowledge - Science of Sports Medicine, including Anatomy, Physiology, Cellular Biology, Epidemiology, ...

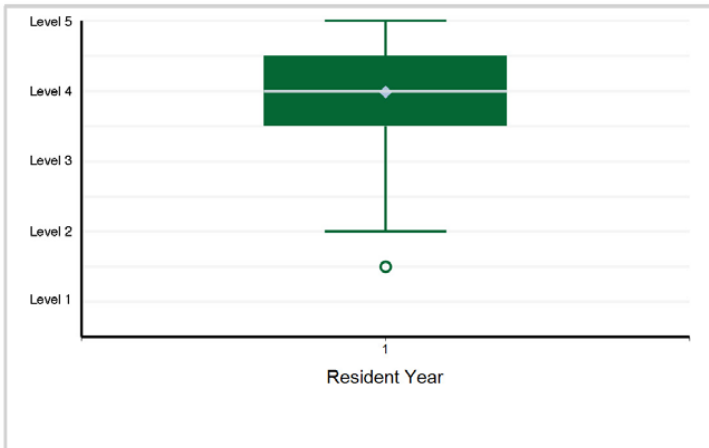

5. Medical Knowledge - Medical Issues in Sports Medicine — Medical Knowledge 2

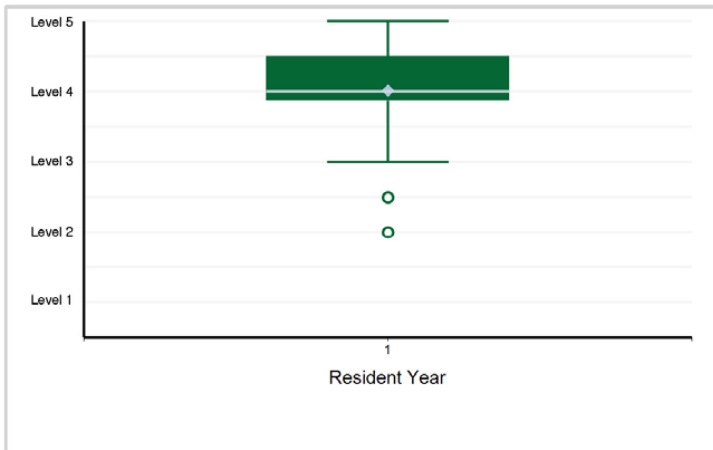

6. Medical Knowledge - Musculoskeletal Issues in Sports Medicine — Medical Knowledge 3

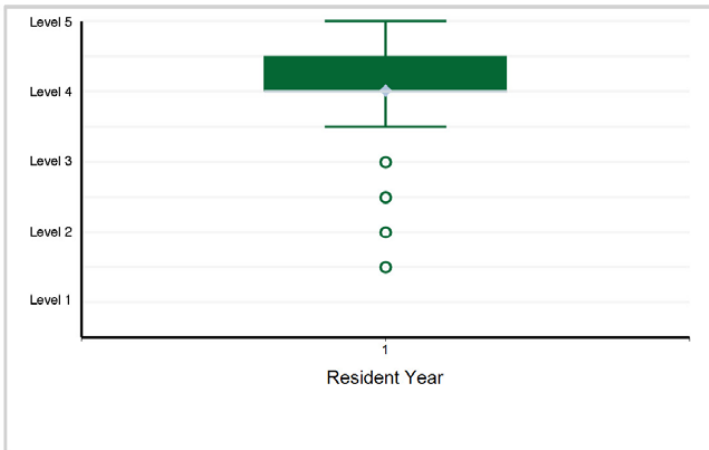

Specialty Box Plot Report - Milestone Evaluation by Resident Year: Year-End 2021-2022

SUBSPECIALTY: Sports Medicine (multidisciplinary, Family Medicine)

7. Systems-Based Practice - Working with Interprofessional Teams (consultants, certified athletic trainers ...)

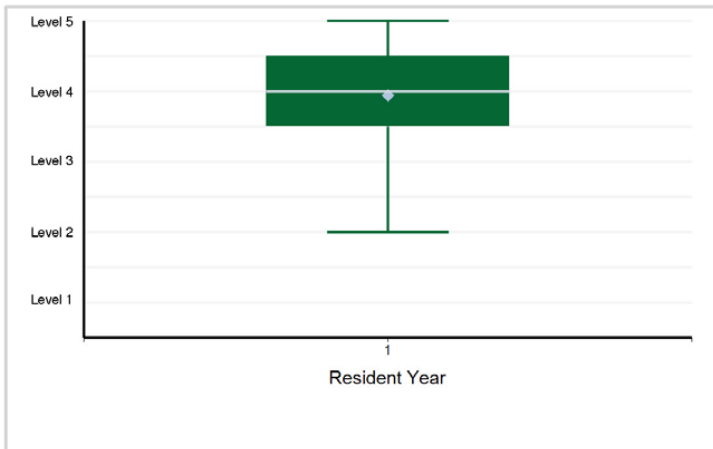

8. Systems-Based Practice - Systems Thinking — Systems-Based Practice 2

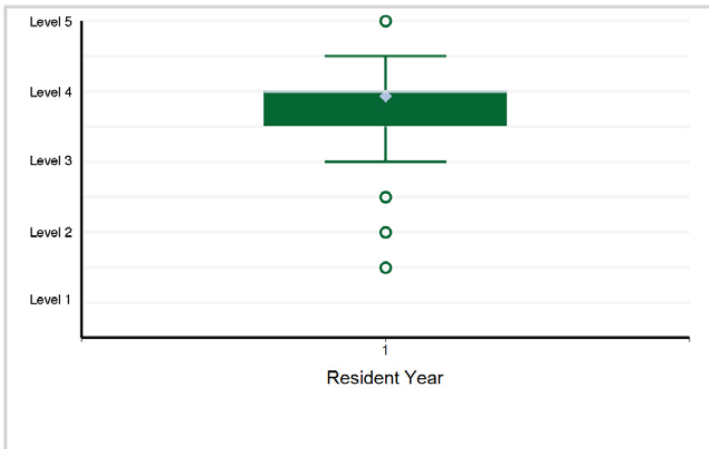

9. Practice-Based Learning and Improvement - Self-directed Learning — Practice-Based Learning and Improvement ...

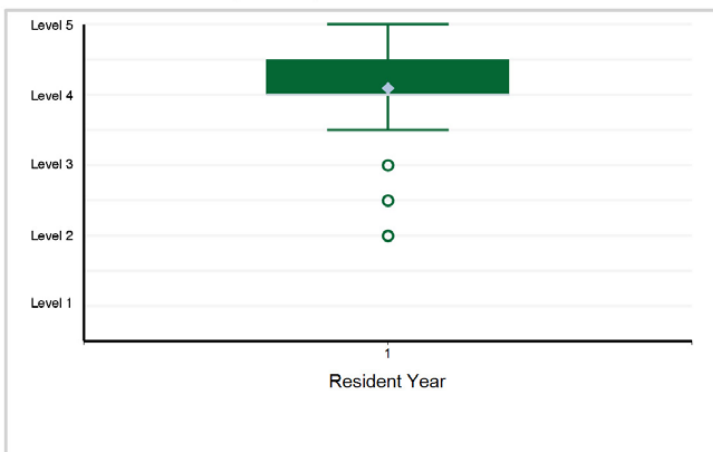

10. Practice-Based Learning and Improvement - Locate, Appraise, and Assimilate Evidence from Scientific ...

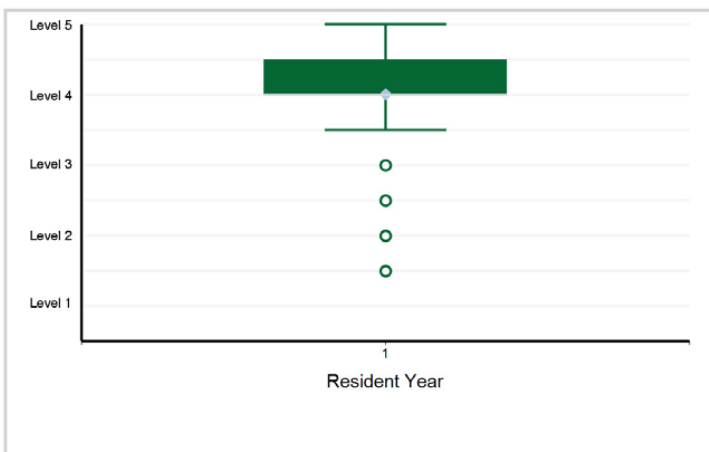

11. Professionalism - Compassion, Integrity, Accountability, and Respect for Self and Others — Professionalism 1

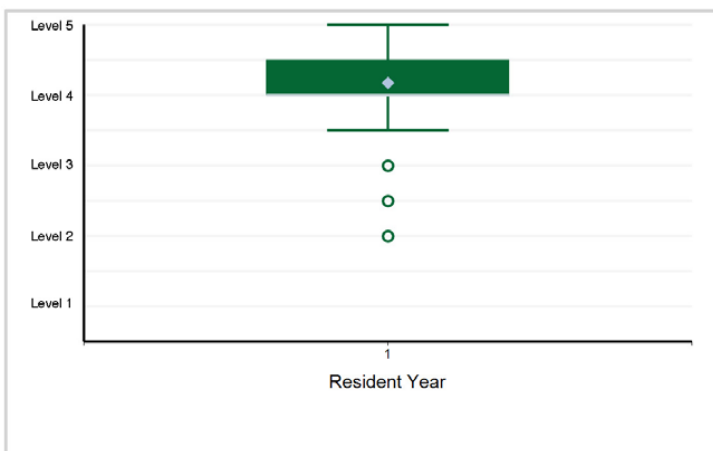

12. Professionalism - Knowledge about and Adherence to the Ethical Principles Relevant to the Practice of Sports Medicine — ...

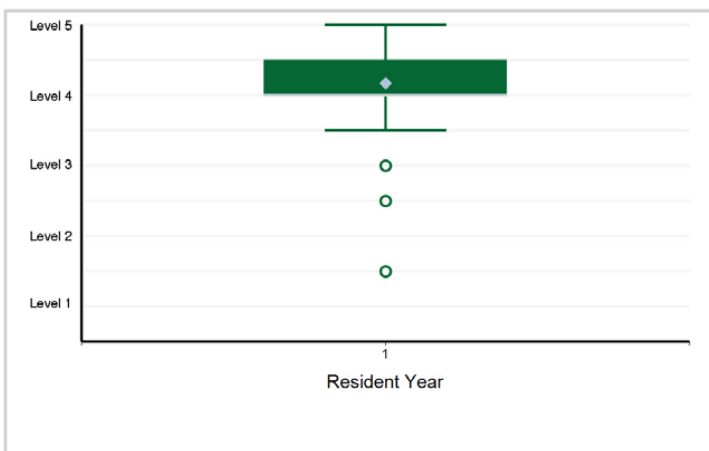

Specialty Box Plot Report - Milestone Evaluation by Resident Year: Year-End 2021-2022

SUBSPECIALTY: **Sports Medicine (multidisciplinary, Family Medicine)**

13. Interpersonal and Communication Skills - Relationship Development, Teamwork, and Managing Conflict — ...

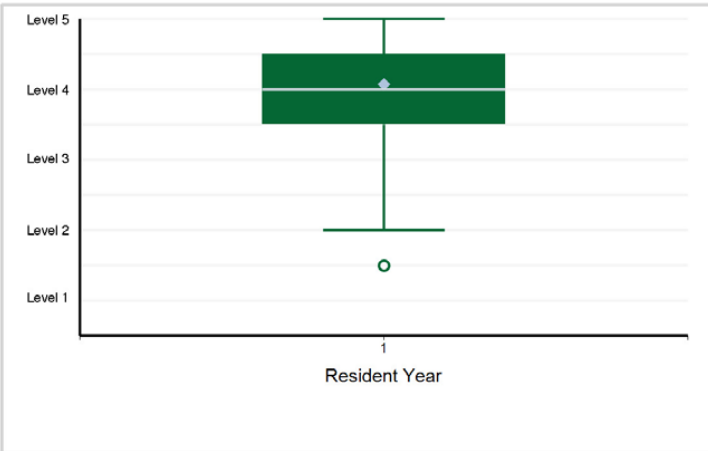

14. Interpersonal and Communication Skills - Information Sharing, Gathering, and Technology — Interpersonal ...



Specialty Box Plot Report - Milestone Evaluation by Resident Year: Year-End 2021-2022

TABLE 28: SPECIALTY: **Internal Medicine**

Resident Year	1	2	3	Total Residents*
# of Residents	12,090	9,722	9,236	31,048

*Note: There are 35 residents with an incomplete milestone evaluation that are excluded from the box plots below.

1. Patient Care - Patient Care 1: History

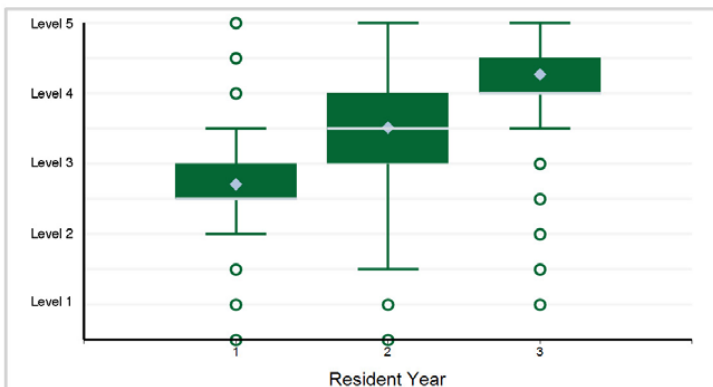

Note: 44 of 31,013 residents have a status of "Not Yet Assessable" and are not included in the analysis.

2. Patient Care - Patient Care 2: Physical Examination

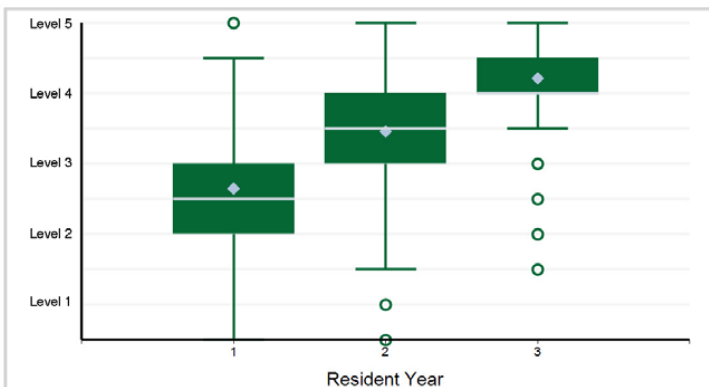

Note: 66 of 31,013 residents have a status of "Not Yet Assessable" and are not included in the analysis.

3. Patient Care - Patient Care 3: Clinical Reasoning

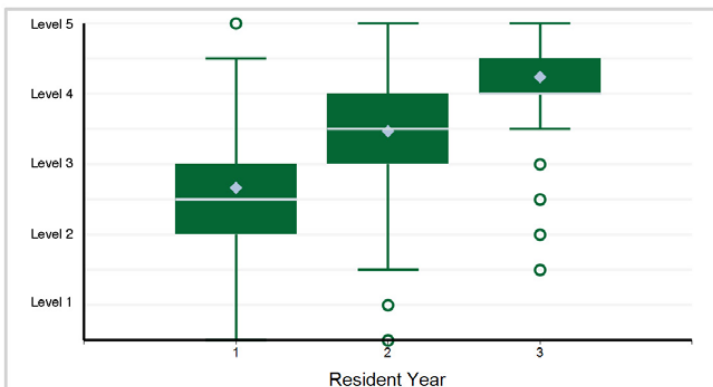

Note: 14 of 31,013 residents have a status of "Not Yet Assessable" and are not included in the analysis.

4. Patient Care - Patient Care 4: Patient Management – Inpatient

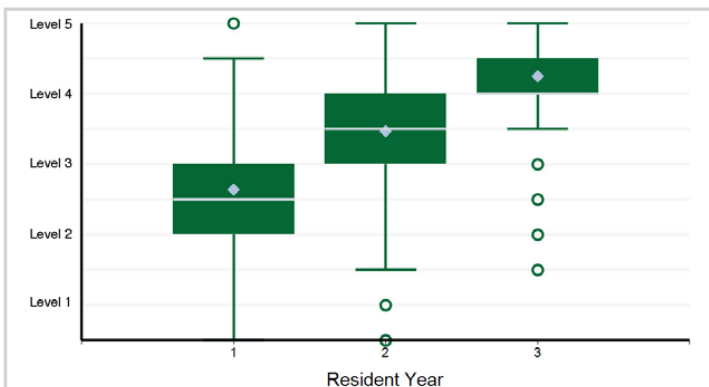

Note: 15 of 31,013 residents have a status of "Not Yet Assessable" and are not included in the analysis.

5. Patient Care - Patient Care 5: Patient Management – Outpatient

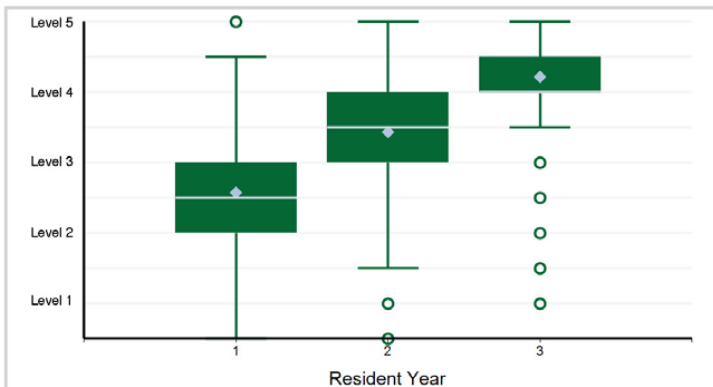

Note: 513 of 31,013 residents have a status of "Not Yet Assessable" and are not included in the analysis.

6. Patient Care - Patient Care 6: Digital Health

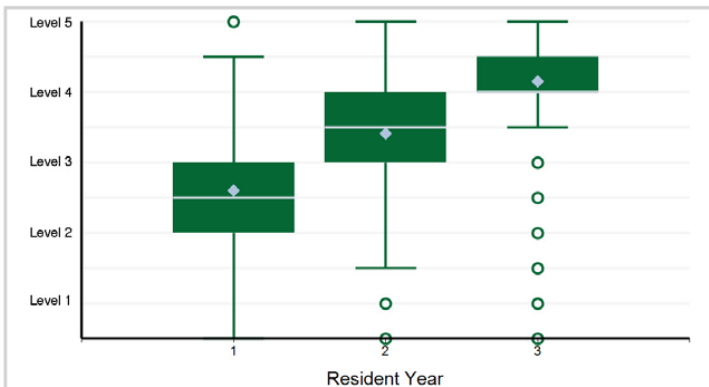

Note: 562 of 31,013 residents have a status of "Not Yet Assessable" and are not included in the analysis.

Specialty Box Plot Report - Milestone Evaluation by Resident Year: Year-End 2021-2022

SPECIALTY: Internal Medicine

7. Medical Knowledge - Medical Knowledge 1: Applied Foundational Sciences

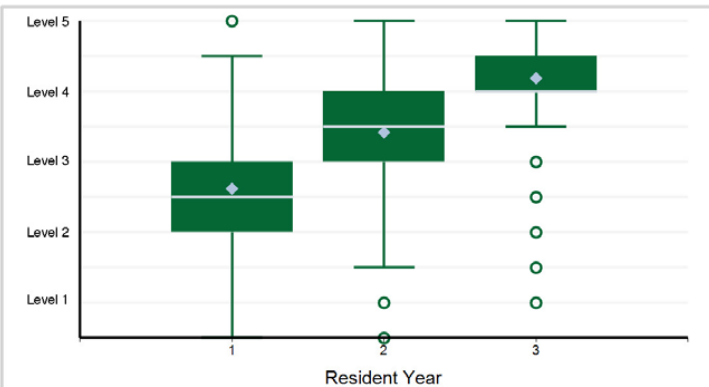

Note: 75 of 31,013 residents have a status of "Not Yet Assessable" and are not included in the analysis.

8. Medical Knowledge - Medical Knowledge 2: Therapeutic Knowledge

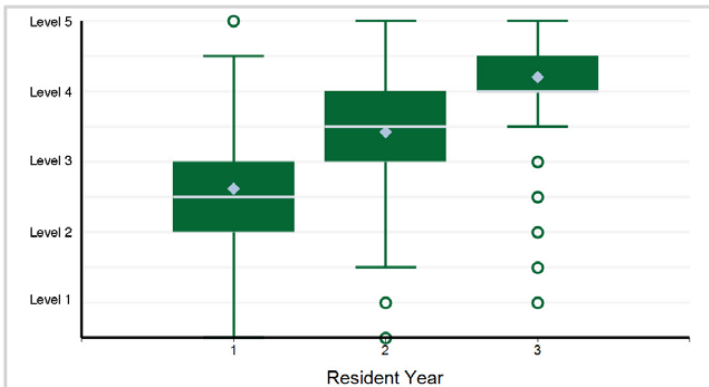

Note: 28 of 31,013 residents have a status of "Not Yet Assessable" and are not included in the analysis.

9. Medical Knowledge - Medical Knowledge 3: Knowledge of Diagnostic Testing

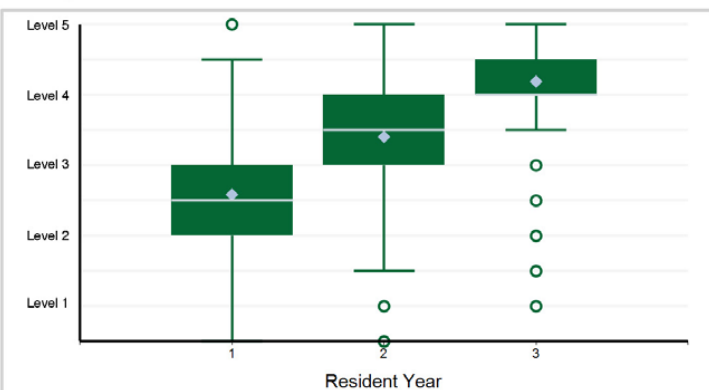

Note: 63 of 31,013 residents have a status of "Not Yet Assessable" and are not included in the analysis.

10. Systems-Based Practice - Systems-Based Practice 1: Patient Safety and Quality Improvement

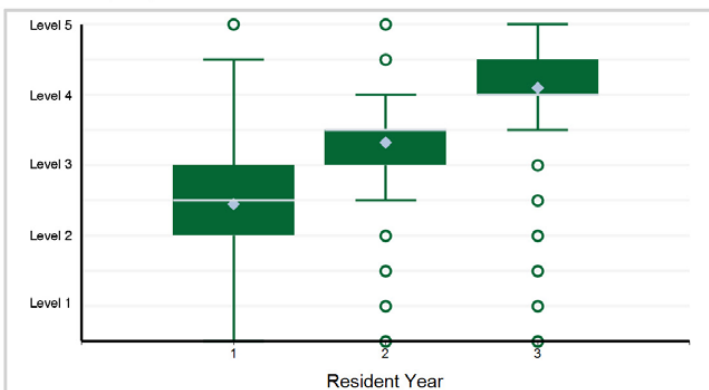

11. Systems-Based Practice - Systems-Based Practice 2: System Navigation for Patient-Centered Care

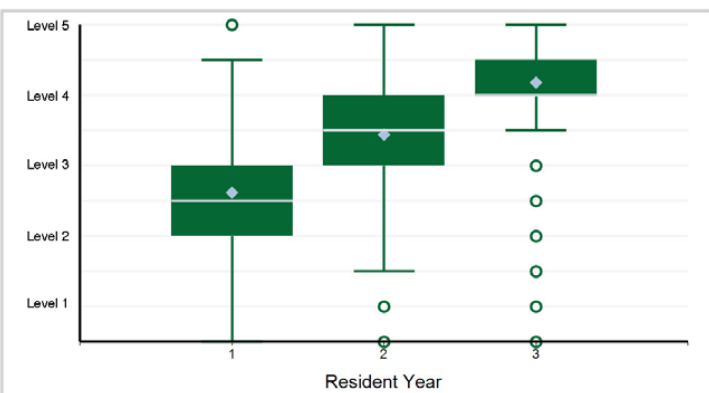

12. Systems-Based Practice - Systems-Based Practice 3: Physician Role in Health Care Systems

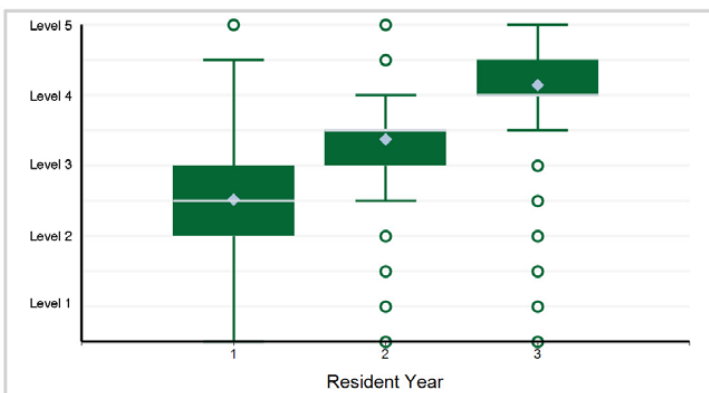

Specialty Box Plot Report - Milestone Evaluation by Resident Year: Year-End 2021-2022

SPECIALTY: Internal Medicine

13. Practice-Based Learning and Improvement - Practice-Based Learning and Improvement 1: Evidence-Based and Informed Practice

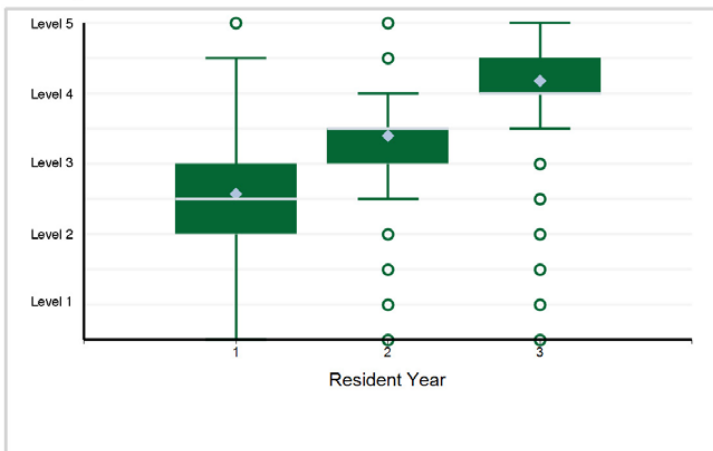

14. Practice-Based Learning and Improvement - Practice-Based Learning and Improvement 2: Reflective Practice and Commitment ...

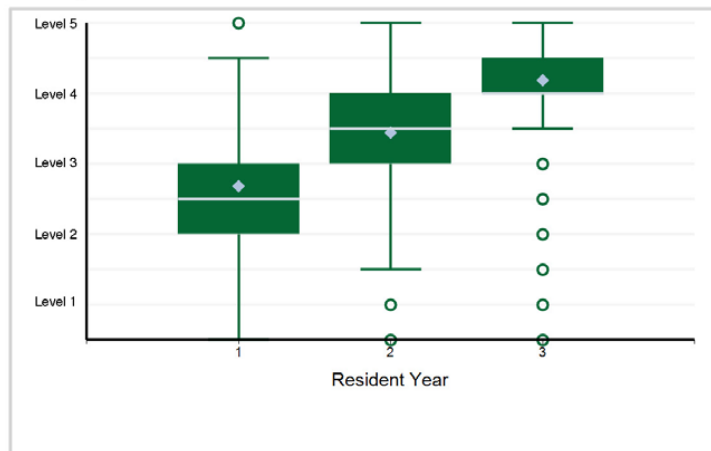

15. Professionalism - Professionalism 1: Professional Behavior

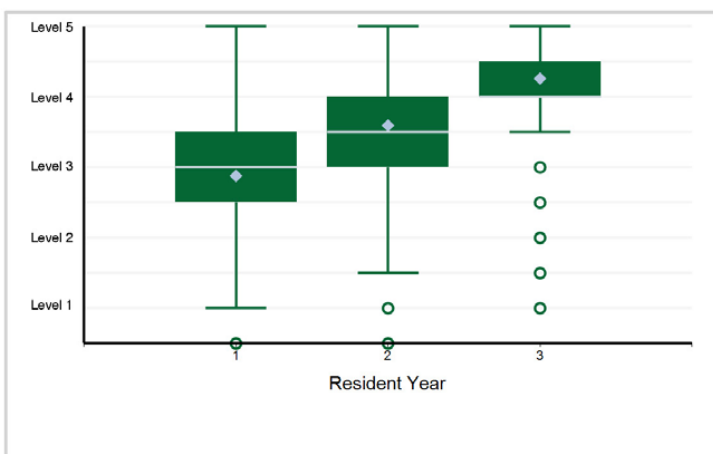

16. Professionalism - Professionalism 2: Ethical Principles

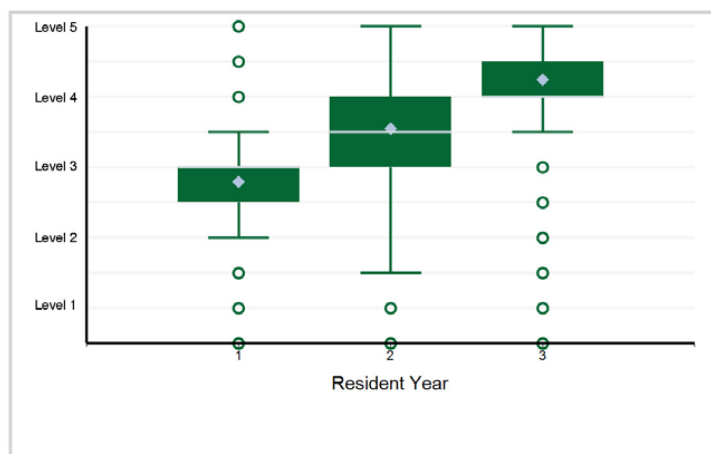

17. Professionalism - Professionalism 3: Accountability/Conscientiousness

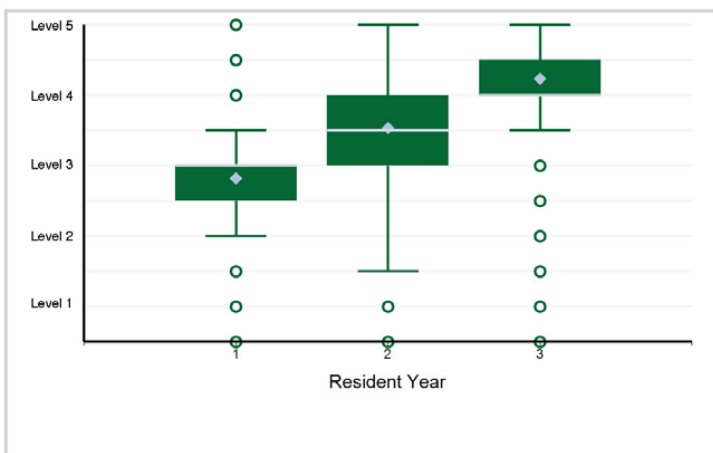

18. Professionalism - Professionalism 4: Knowledge of Systemic and Individual Factors of Well-Being* *This subcompetency is ...

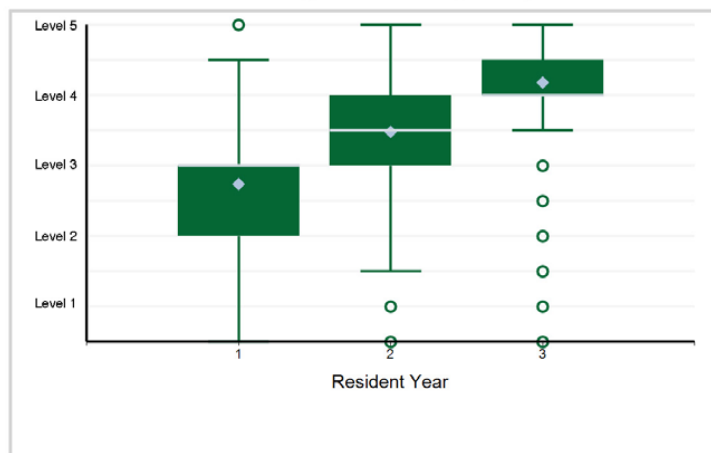

Specialty Box Plot Report - Milestone Evaluation by Resident Year: Year-End 2021-2022

SPECIALTY: **Internal Medicine**

19. Interpersonal and Communication Skills - Interpersonal and Communication Skills 1: Patient- and Family-Centered Communication

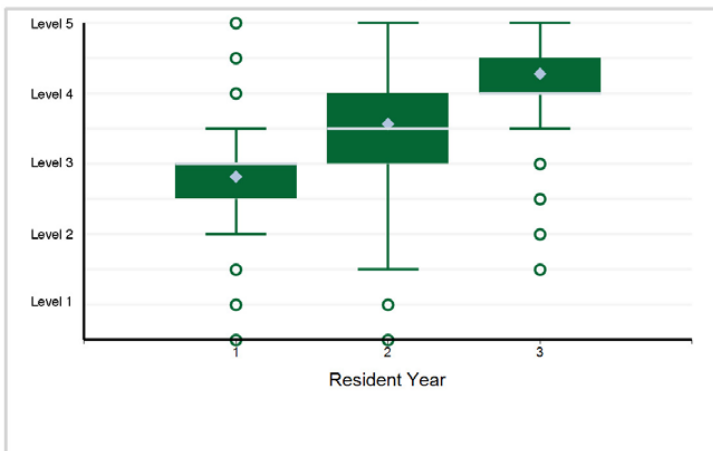

20. Interpersonal and Communication Skills - Interpersonal and Communication Skills 2: Interprofessional and Team Communication

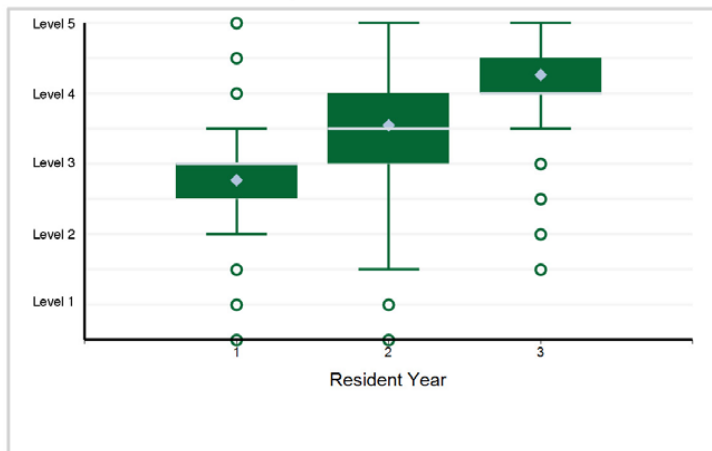

21. Interpersonal and Communication Skills - Interpersonal and Communication Skills 3: Communication within Health Care Systems

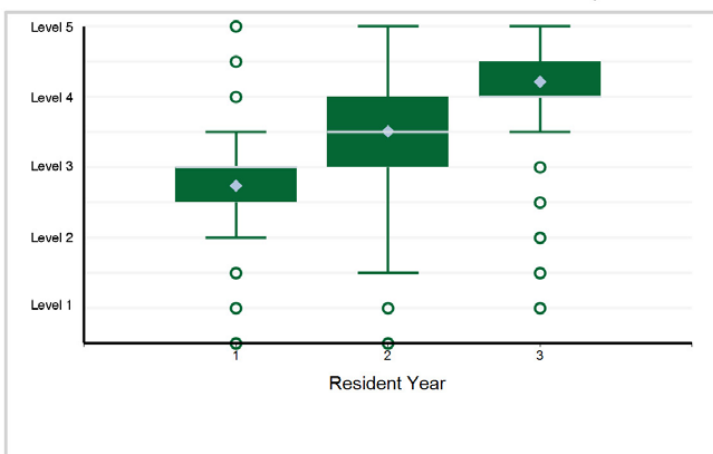

Specialty Box Plot Report - Milestone Evaluation by Resident Year: Year-End 2021-2022

TABLE 29: SUBSPECIALTY: **Adult Congenital Heart Disease**

Resident Year	1	2	Total Residents
# of Residents	17	17	34

1. Patient Care - Gathers and synthesizes essential and accurate information to define each patient's clinical problem(s). ...

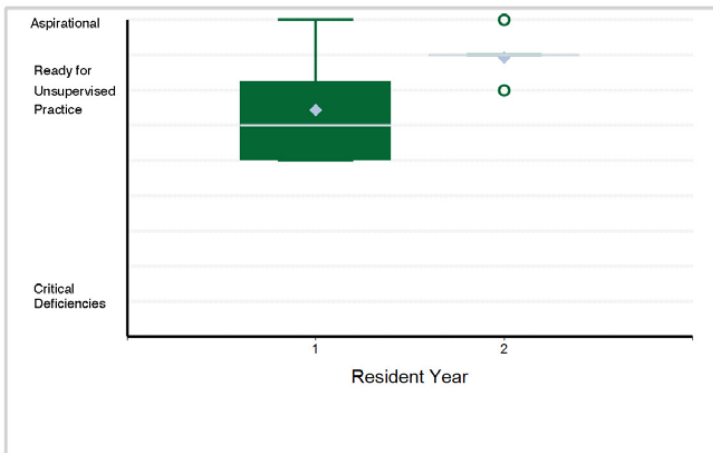

2. Patient Care - Develops and achieves comprehensive management plan for each patient. (PC2)

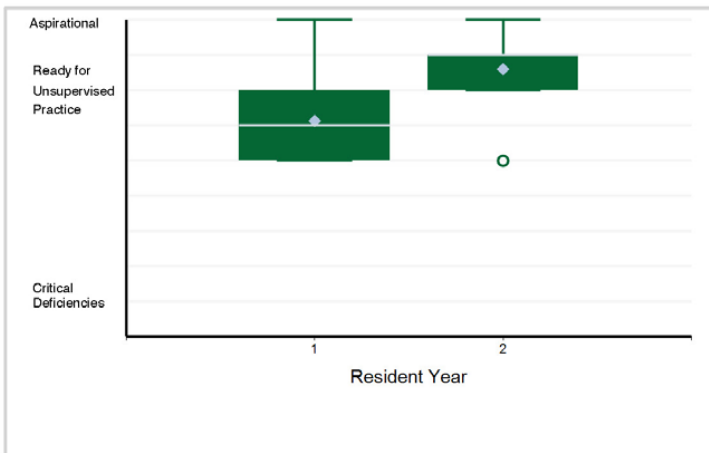

3. Patient Care - Manages patients with progressive responsibility and independence. (PC3)

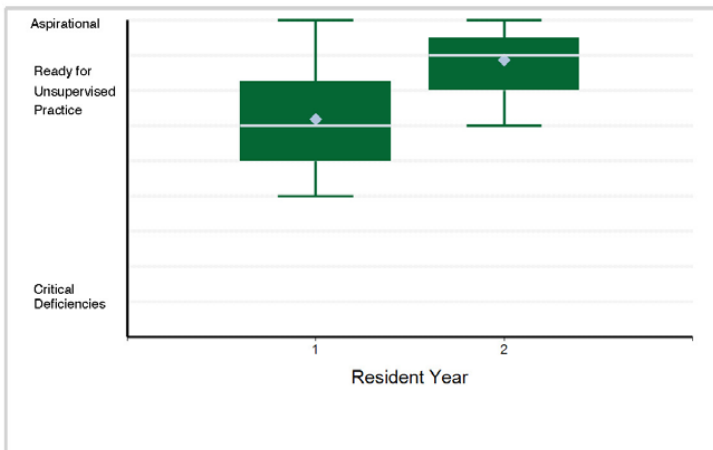

4. Patient Care - Demonstrates skill in performing and interpreting invasive procedures. (PC4a)

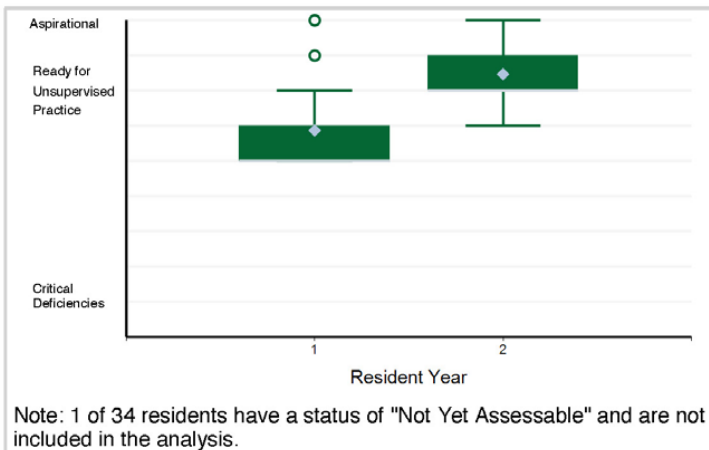

5. Patient Care - Demonstrates skill in performing and interpreting non-invasive procedures and/or testing. (PC4b)

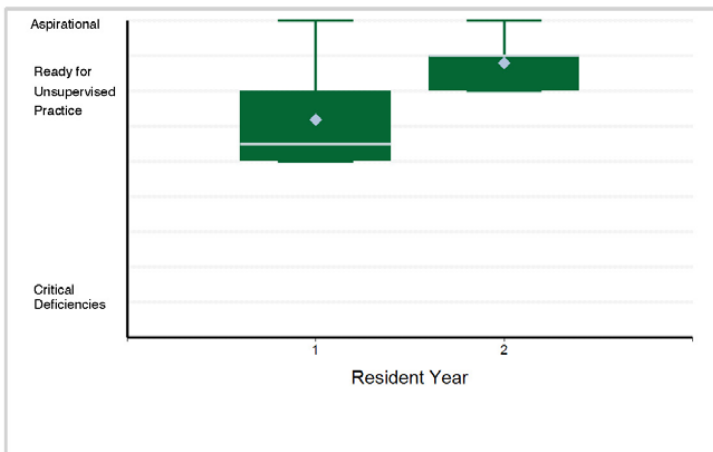

6. Patient Care - Requests and provides consultative care. (PC5)

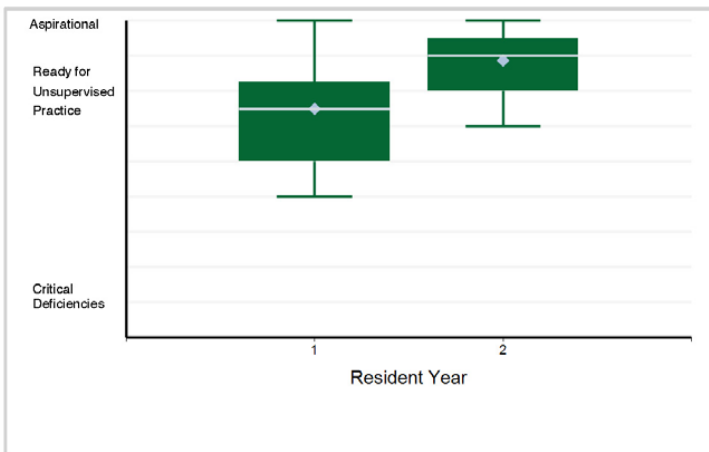

Specialty Box Plot Report - Milestone Evaluation by Resident Year: Year-End 2021-2022

SUBSPECIALTY: Adult Congenital Heart Disease

7. Medical Knowledge - Possesses Clinical knowledge (MK1)

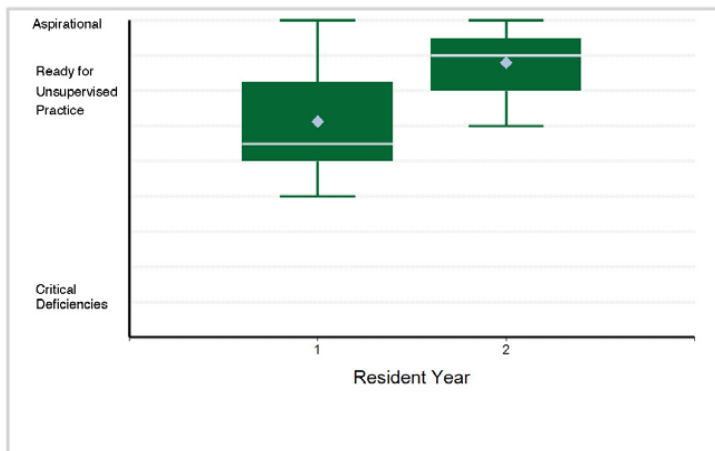

8. Medical Knowledge - Knowledge of diagnostic testing and procedures. (MK2)

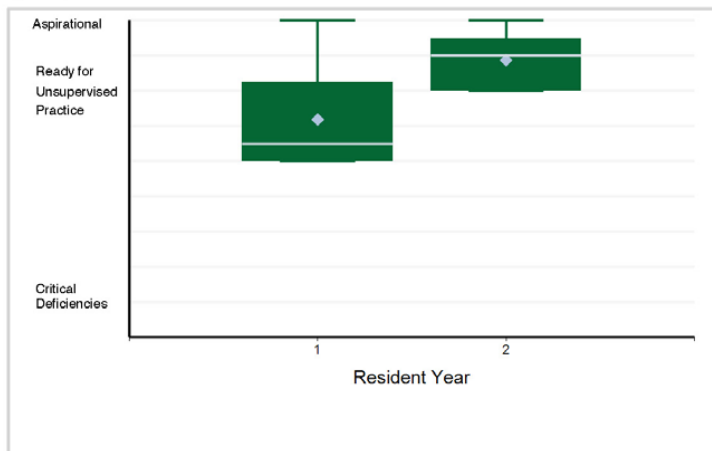

9. Medical Knowledge - Scholarship. (MK3)

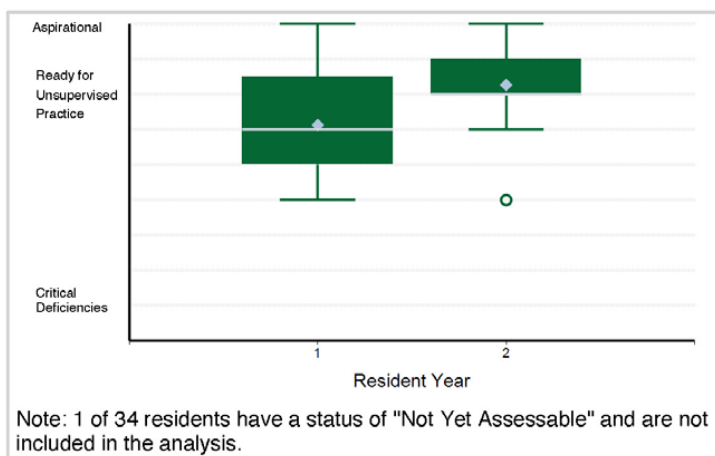

10. Systems-Based Practice - Works effectively within an interprofessional team (e.g., with peers, consultants, ...)

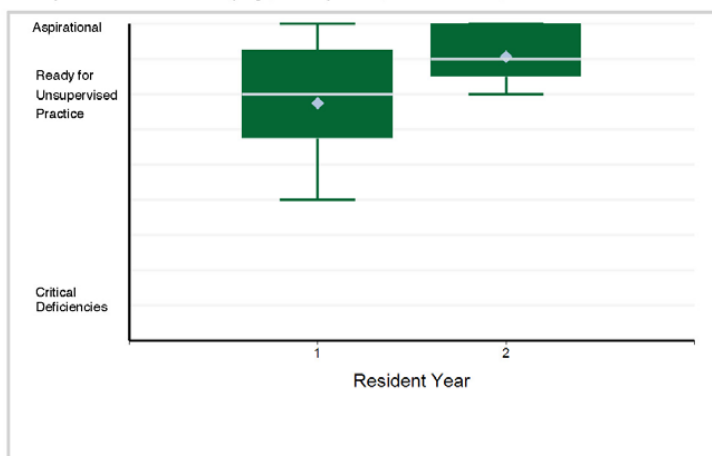

11. Systems-Based Practice - Recognizes system error and advocates for system improvement. (SBP2)

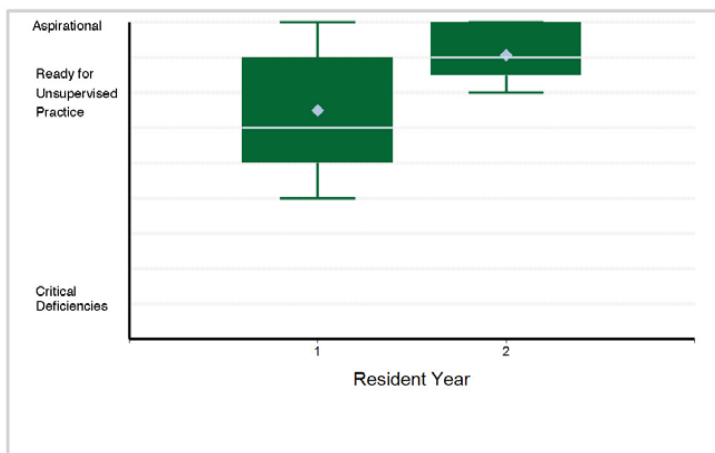

12. Systems-Based Practice - Identifies forces that impact the cost of health care, and advocates for and ...

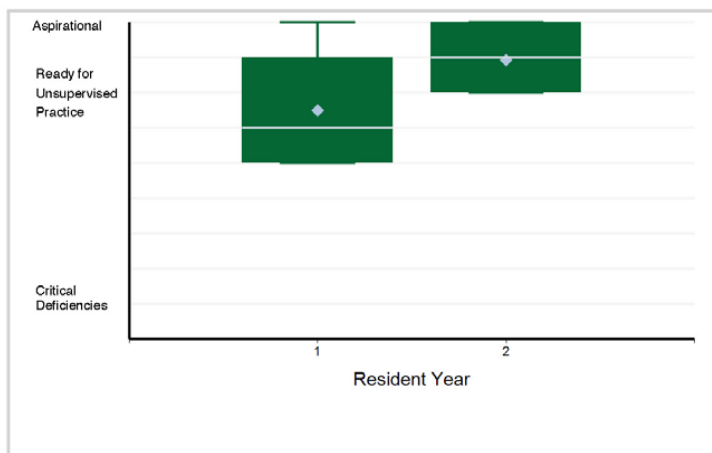

Specialty Box Plot Report - Milestone Evaluation by Resident Year: Year-End 2021-2022

SUBSPECIALTY: Adult Congenital Heart Disease

13. Systems-Based Practice - Transitions patients effectively within and across health delivery systems. (SBP4)

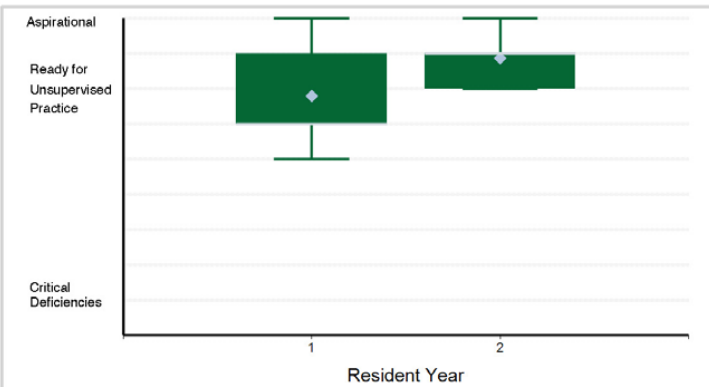

Note: 1 of 34 residents have a status of "Not Yet Assessable" and are not included in the analysis.

14. Practice-Based Learning and Improvement - Monitors practice with a goal for improvement. (PBLI1)

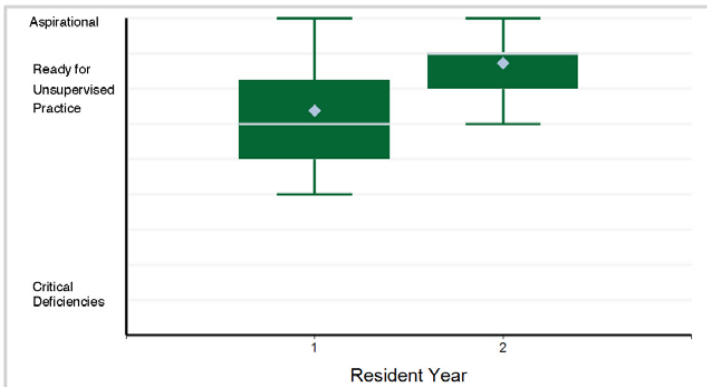

15. Practice-Based Learning and Improvement - Learns and improves via performance audit. (PBLI2)

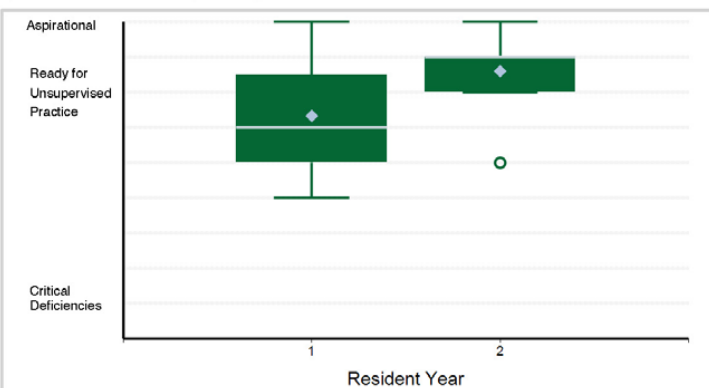

Note: 1 of 34 residents have a status of "Not Yet Assessable" and are not included in the analysis.

16. Practice-Based Learning and Improvement - Learns and improves via feedback. (PBLI3)

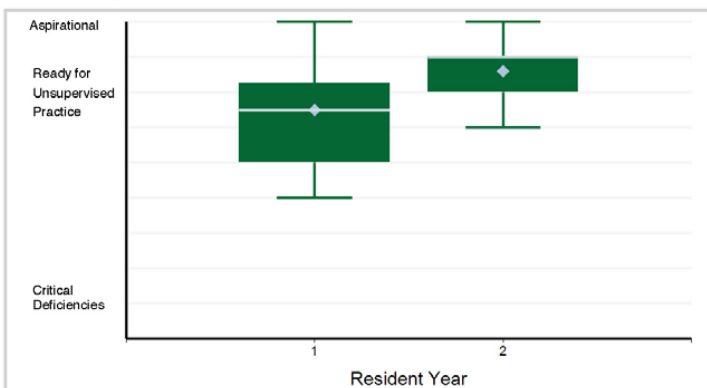

17. Practice-Based Learning and Improvement - Learns and improves at the point of care. (PBLI4)

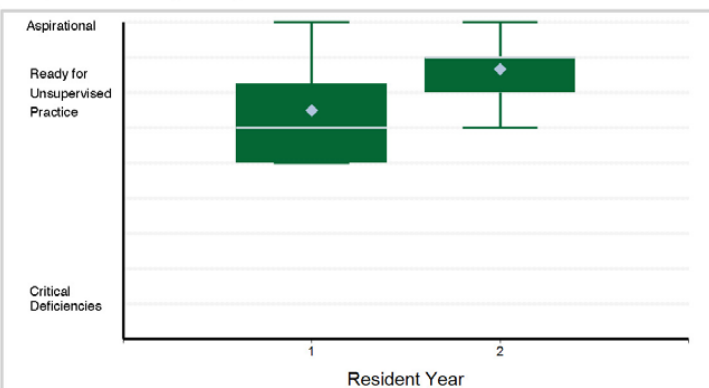

18. Professionalism - Has professional and respectful interactions with patients, caregivers, and members ...

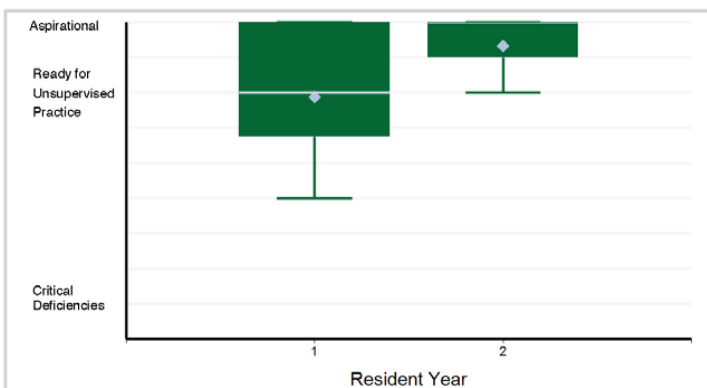

Specialty Box Plot Report - Milestone Evaluation by Resident Year: Year-End 2021-2022

SUBSPECIALTY: Adult Congenital Heart Disease

19. Professionalism - Accepts responsibility and follows through on tasks. (PROF2)

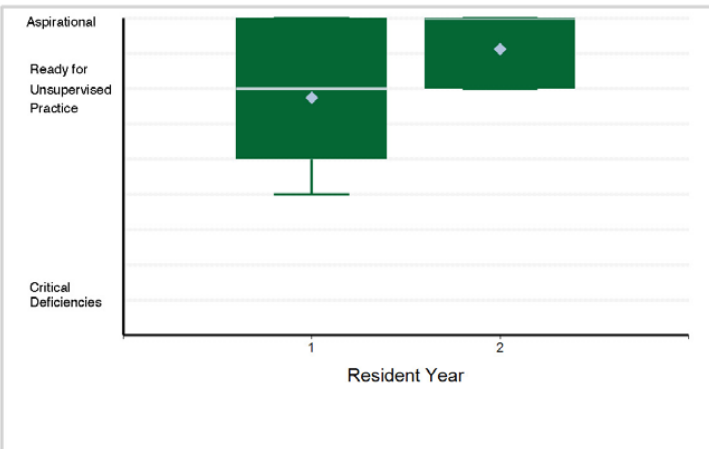

20. Professionalism - Responds to each patient's unique characteristics and needs. (PROF3)

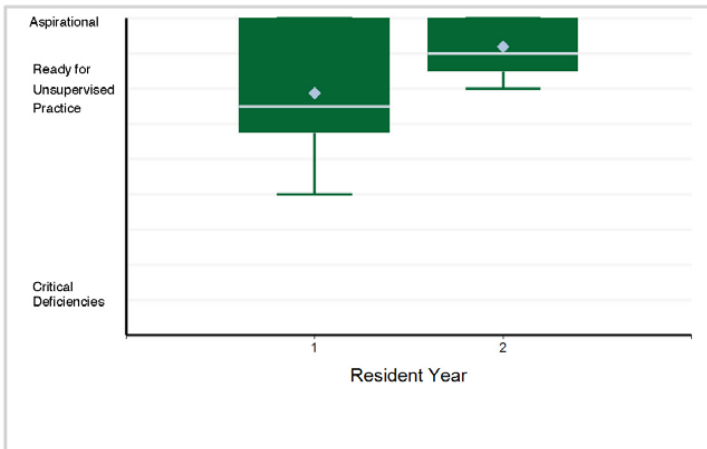

21. Professionalism - Exhibits integrity and ethical behavior in professional conduct. (PROF4)

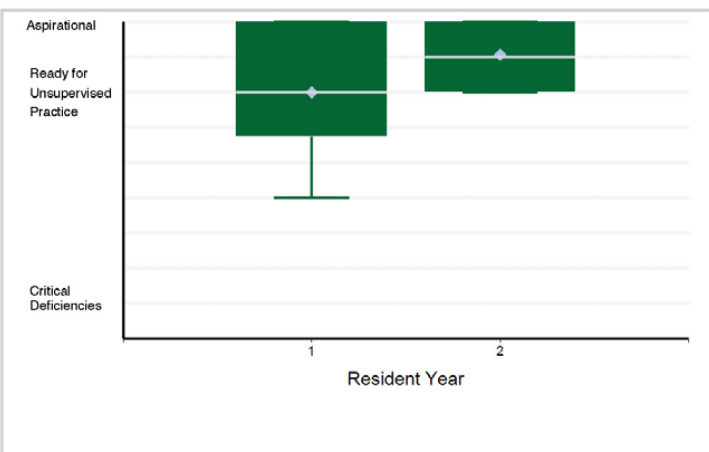

22. Interpersonal and Communication Skills - Communicates effectively with patients and caregivers. (ICS1)

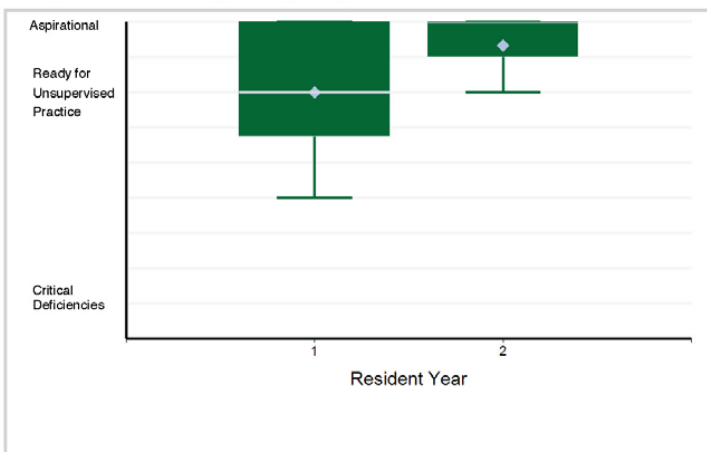

23. Interpersonal and Communication Skills - Communicates effectively in interprofessional teams (e.g., ...)

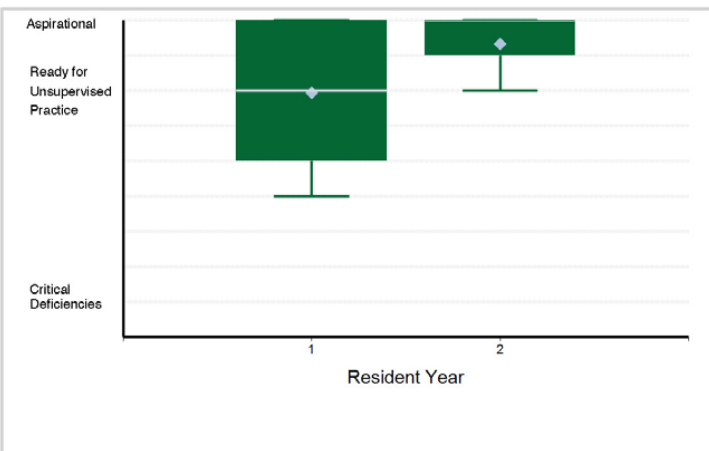

24. Interpersonal and Communication Skills - Appropriate utilization and completion of health records. (ICS3)

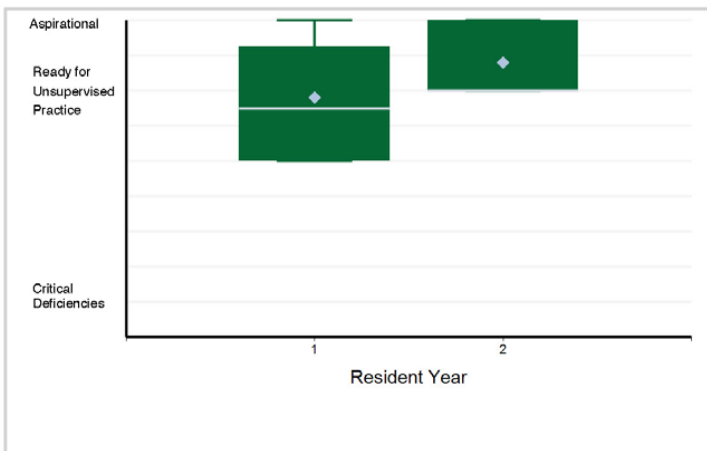

Specialty Box Plot Report - Milestone Evaluation by Resident Year: Year-End 2021-2022

TABLE 30: SUBSPECIALTY: **Advanced Heart Failure and Transplant Cardiology**

Resident Year	1	Total Residents
# of Residents	103	103

1. Patient Care - Patient Care 1: Transplant

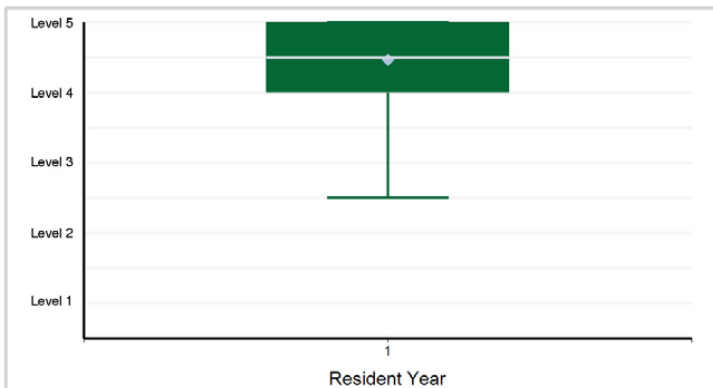

Note: 1 of 103 residents have a status of "Not Yet Assessable" and are not included in the analysis.

2. Patient Care - Patient Care 2: Mechanical Circulatory Support (Temporary and Durable)

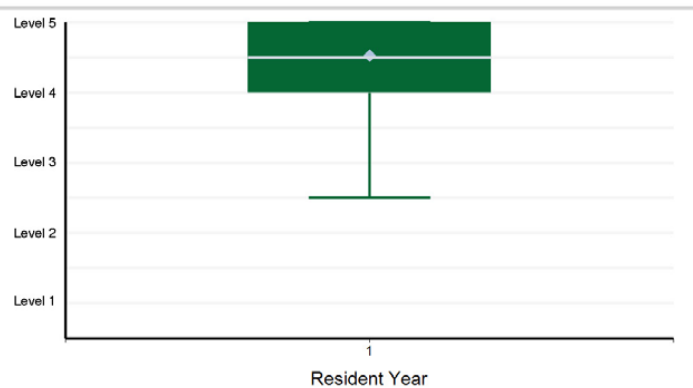

Note: 1 of 103 residents have a status of "Not Yet Assessable" and are not included in the analysis.

3. Patient Care - Patient Care 3: Acutely Decompensated Heart Failure

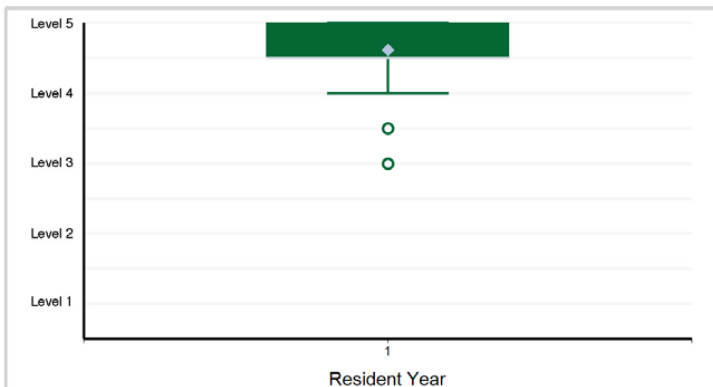

Note: 2 of 103 residents have a status of "Not Yet Assessable" and are not included in the analysis.

4. Patient Care - Patient Care 4: Management of Chronic Heart Failure

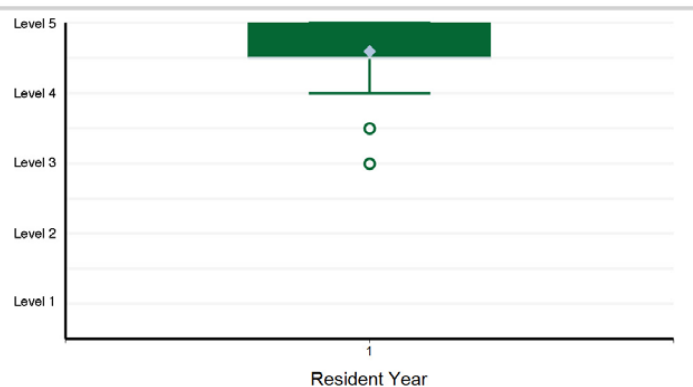

Note: 2 of 103 residents have a status of "Not Yet Assessable" and are not included in the analysis.

5. Patient Care - Patient Care 5: Pulmonary Hypertension

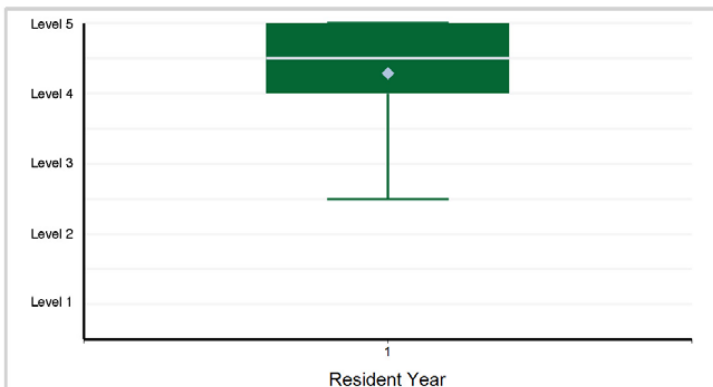

Note: 1 of 103 residents have a status of "Not Yet Assessable" and are not included in the analysis.

6. Medical Knowledge - Medical Knowledge 1: Transplant

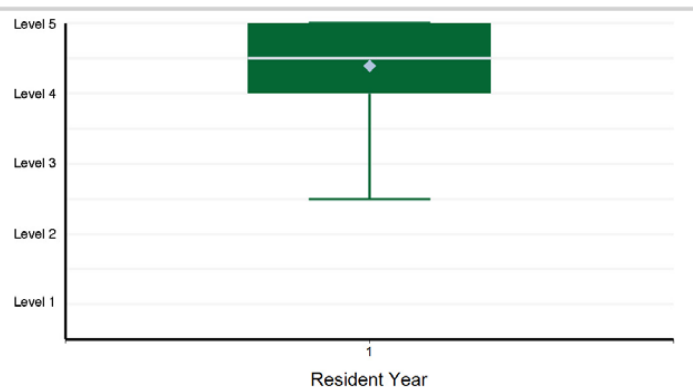

Note: 1 of 103 residents have a status of "Not Yet Assessable" and are not included in the analysis.

Specialty Box Plot Report - Milestone Evaluation by Resident Year: Year-End 2021-2022

SUBSPECIALTY: Advanced Heart Failure and Transplant Cardiology

7. Medical Knowledge - Medical Knowledge 2: Mechanical Circulatory Support

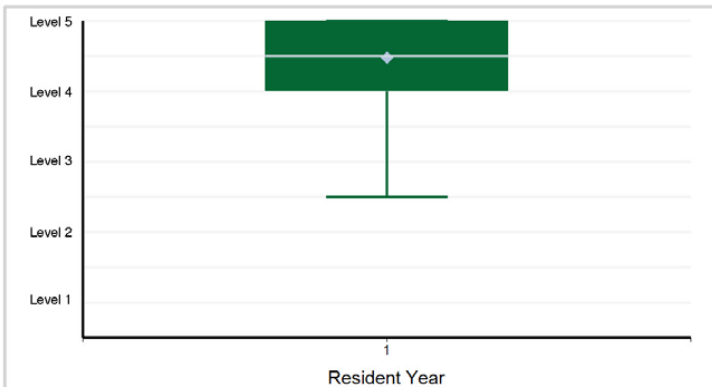

Note: 1 of 103 residents have a status of "Not Yet Assessable" and are not included in the analysis.

8. Medical Knowledge - Medical Knowledge 3: Heart Failure

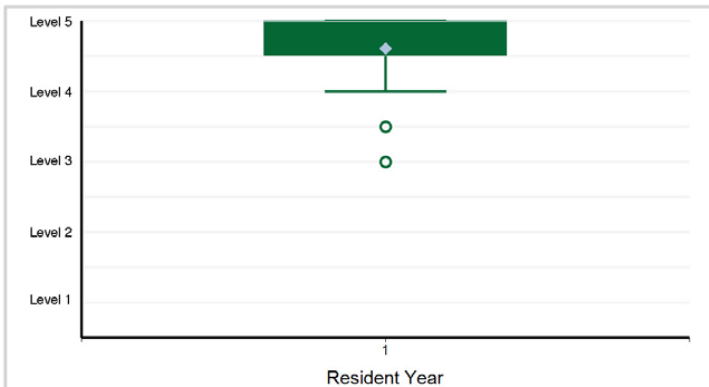

Note: 1 of 103 residents have a status of "Not Yet Assessable" and are not included in the analysis.

9. Medical Knowledge - Medical Knowledge 4: Advanced Heart Failure Diagnostics

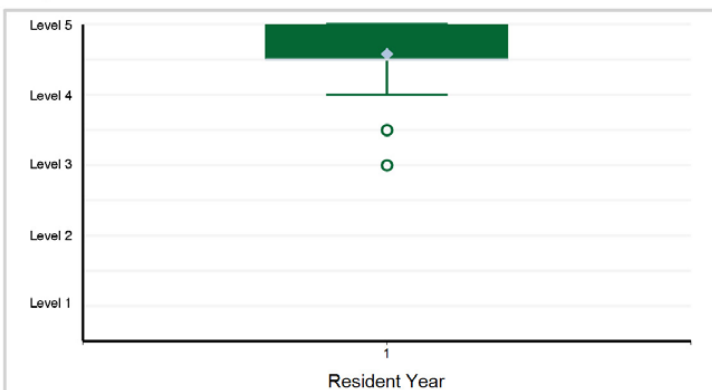

Note: 1 of 103 residents have a status of "Not Yet Assessable" and are not included in the analysis.

10. Medical Knowledge - Medical Knowledge 5: Pulmonary Hypertension

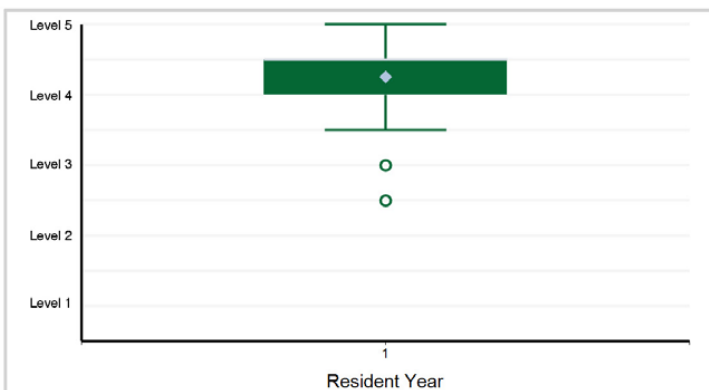

Note: 1 of 103 residents have a status of "Not Yet Assessable" and are not included in the analysis.

11. Systems-Based Practice - Systems-Based Practice 1: Patient Safety and Quality Improvement

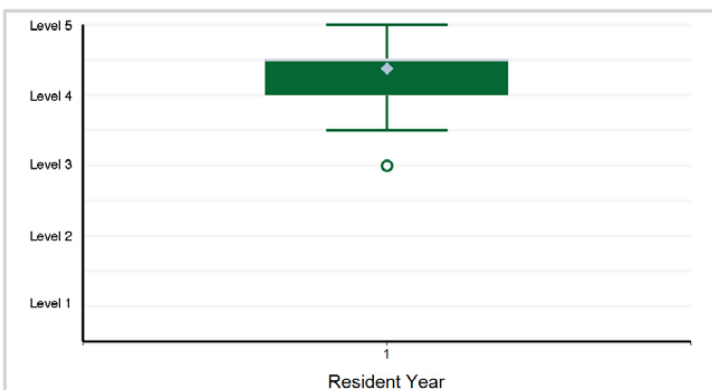

12. Systems-Based Practice - Systems-Based Practice 2: System Navigation for Patient-Centered Care

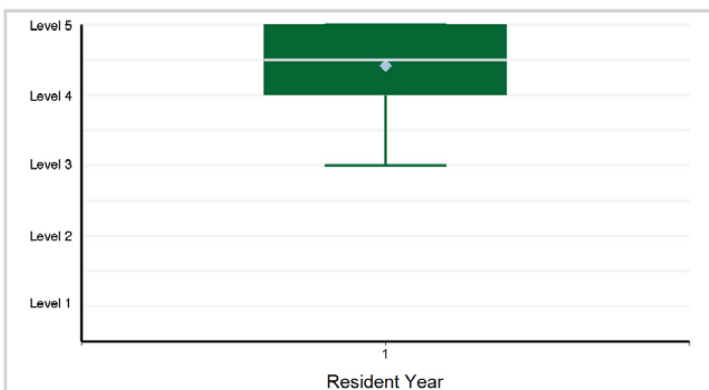

Specialty Box Plot Report - Milestone Evaluation by Resident Year: Year-End 2021-2022

SUBSPECIALTY: Advanced Heart Failure and Transplant Cardiology

13. Systems-Based Practice - Systems-Based Practice 3: Physician Role in Health Care Systems

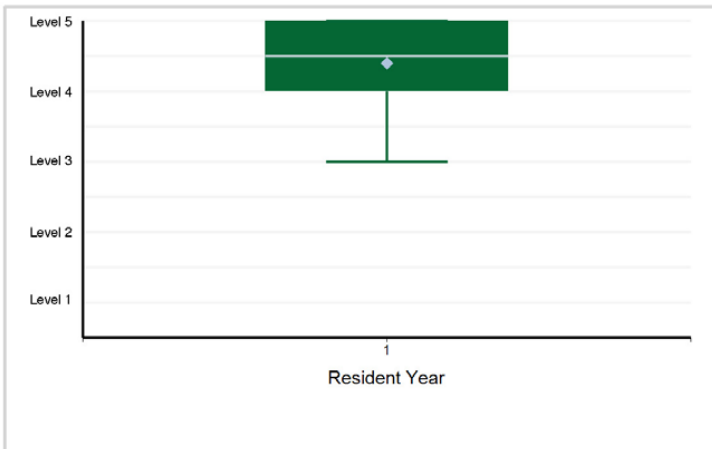

14. Practice-Based Learning and Improvement - Practice-Based Learning and Improvement 1: Evidence-Based and Informed Practice

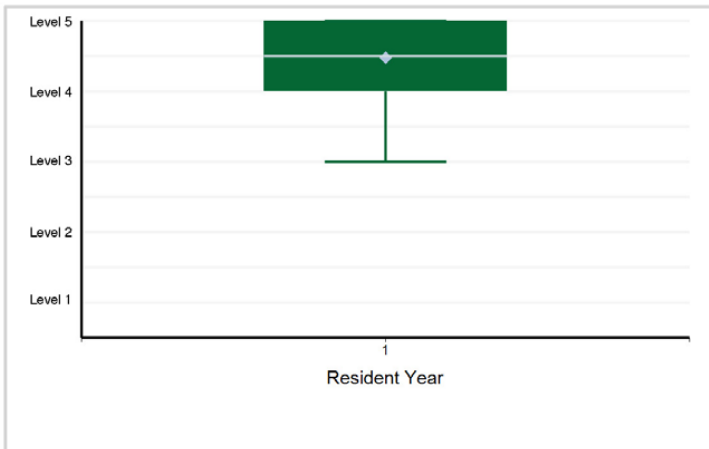

15. Practice-Based Learning and Improvement - Practice-Based Learning and Improvement 2: Reflective Practice and Commitment ...

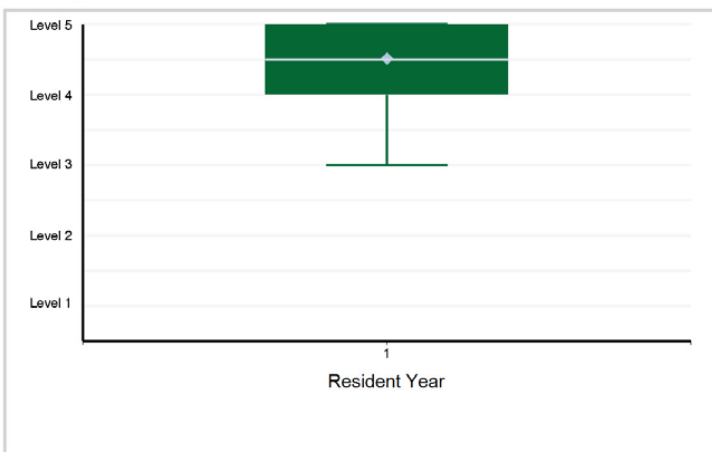

16. Professionalism - Professionalism 1: Professional Behavior and Ethical Principles

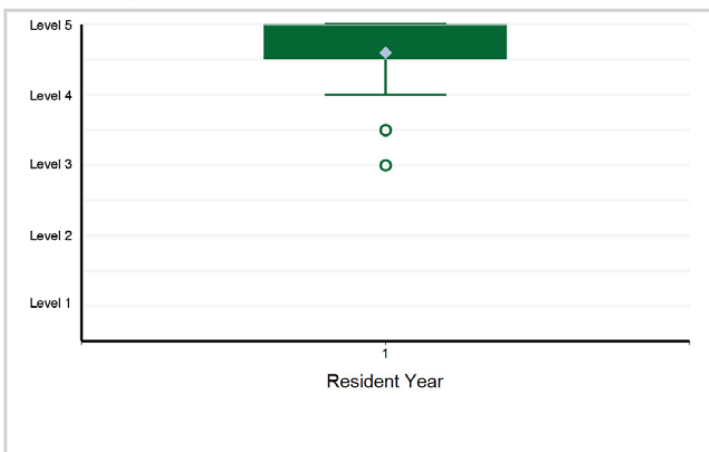

17. Professionalism - Professionalism 2: Accountability

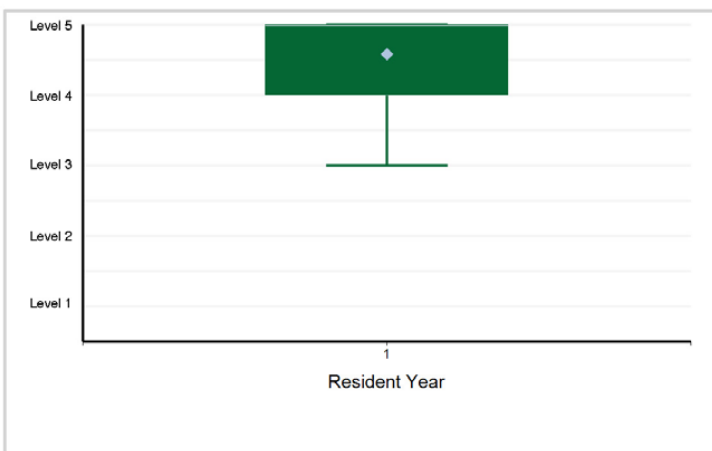

18. Professionalism - Professionalism 3: Self-Awareness and Well-Being

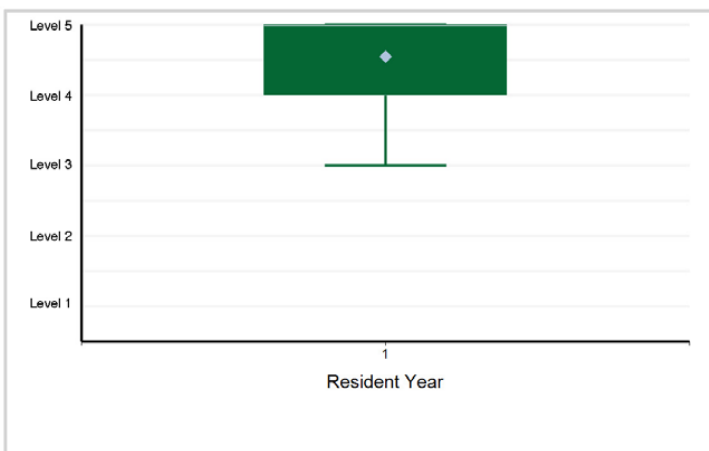

Specialty Box Plot Report - Milestone Evaluation by Resident Year: Year-End 2021-2022

SUBSPECIALTY: Advanced Heart Failure and Transplant Cardiology

19. Interpersonal and Communication Skills - Interpersonal and Communication Skills 1: Patient- and Family-Centered Communication

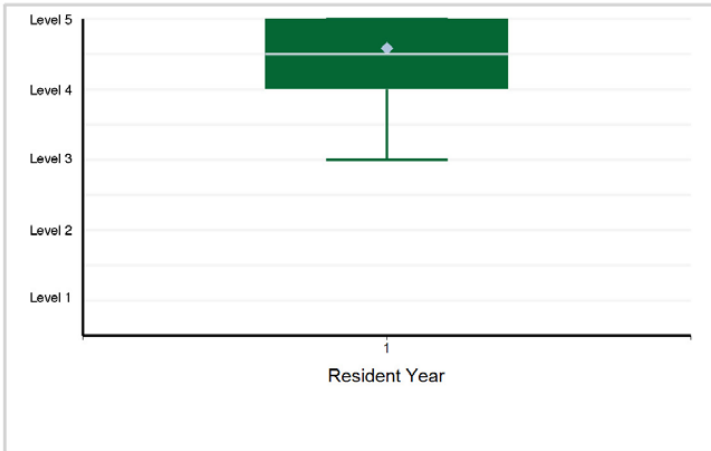

20. Interpersonal and Communication Skills - Interpersonal and Communication Skills 2: Interprofessional and Team Communication

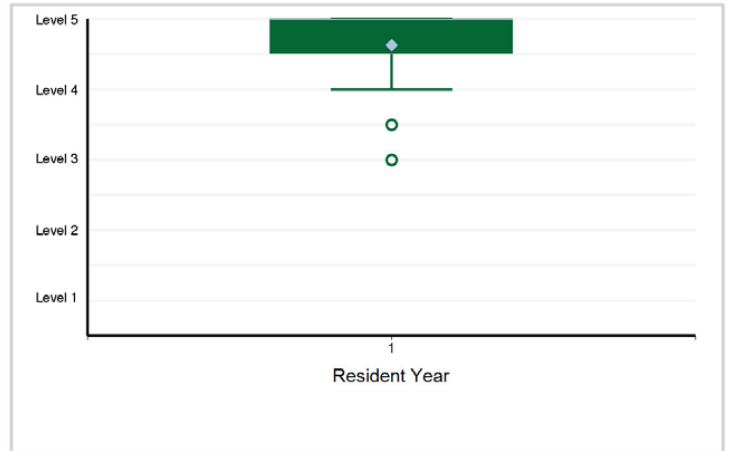

21. Interpersonal and Communication Skills - Interpersonal and Communication Skills 3: Communication within Health Care Systems

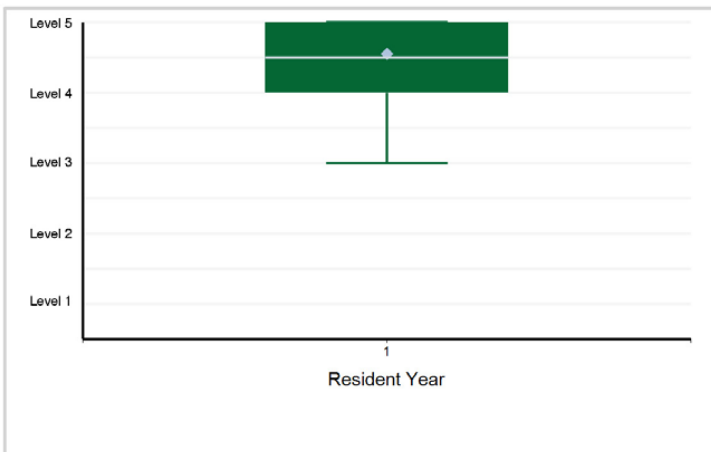

Specialty Box Plot Report - Milestone Evaluation by Resident Year: Year-End 2021-2022

TABLE 31: SUBSPECIALTY: **Cardiovascular Disease**

Resident Year	1	2	3	Total Residents
# of Residents	1,149	1,101	1,072	3,322

1. Patient Care - Patient Care 1: Invasive Cardiovascular Testing

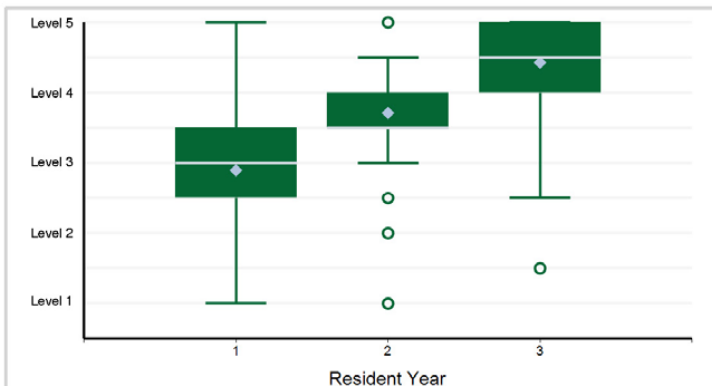

Note: 16 of 3,322 residents have a status of "Not Yet Assessable" and are not included in the analysis.

2. Patient Care - Patient Care 2: Non-Invasive Testing

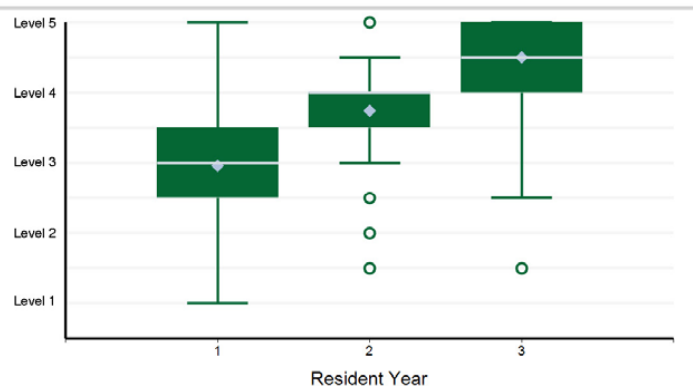

Note: 11 of 3,322 residents have a status of "Not Yet Assessable" and are not included in the analysis.

3. Patient Care - Patient Care 3: Acute Care

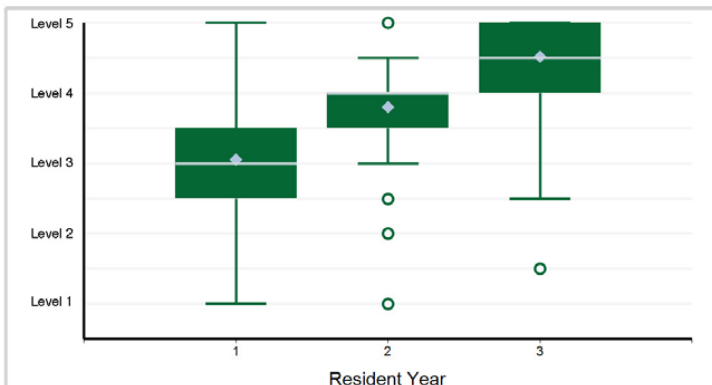

Note: 4 of 3,322 residents have a status of "Not Yet Assessable" and are not included in the analysis.

4. Patient Care - Patient Care 4: Chronic Care for Cardiovascular Conditions

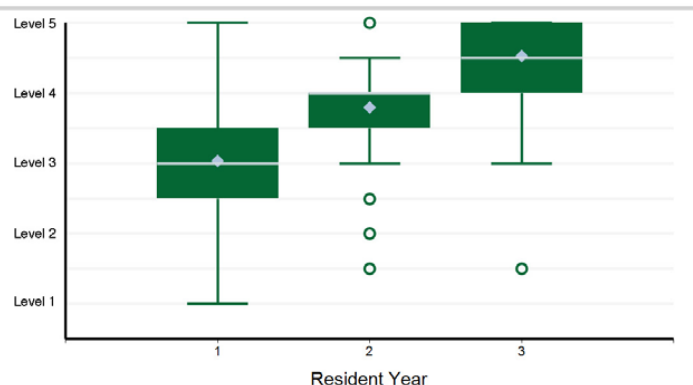

Note: 6 of 3,322 residents have a status of "Not Yet Assessable" and are not included in the analysis.

5. Medical Knowledge - Medical Knowledge 1: Cardiovascular Testing

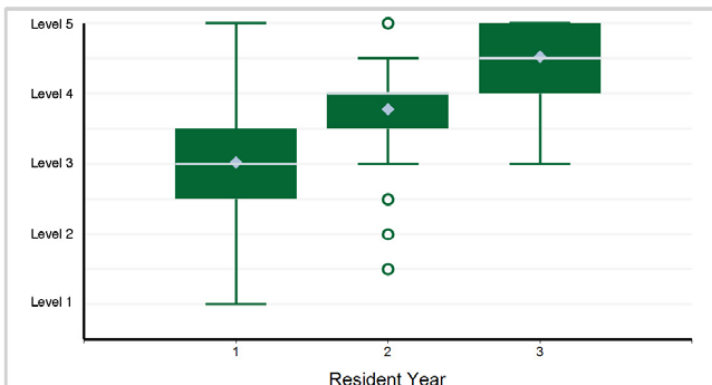

Note: 2 of 3,322 residents have a status of "Not Yet Assessable" and are not included in the analysis.

6. Medical Knowledge - Medical Knowledge 2: Critical Thinking for Diagnosis and Therapy

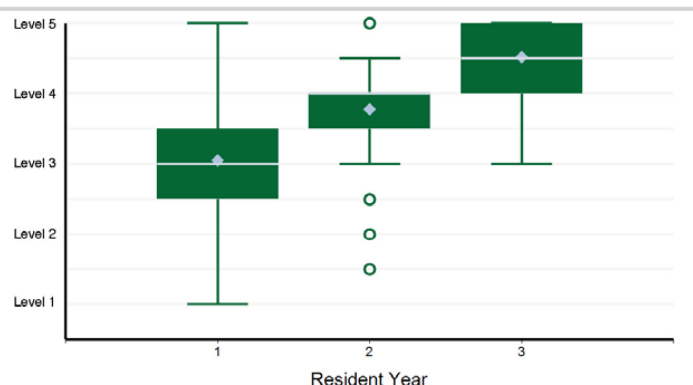

Note: 2 of 3,322 residents have a status of "Not Yet Assessable" and are not included in the analysis.

Specialty Box Plot Report - Milestone Evaluation by Resident Year: Year-End 2021-2022

SUBSPECIALTY: Cardiovascular Disease

7. Systems-Based Practice - Systems-Based Practice 1: Patient Safety and Quality Improvement

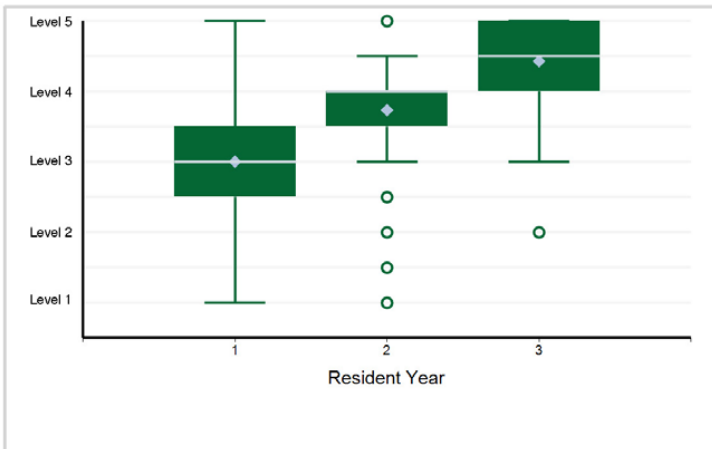

8. Systems-Based Practice - Systems-Based Practice 2: System Navigation for Patient-Centered Care

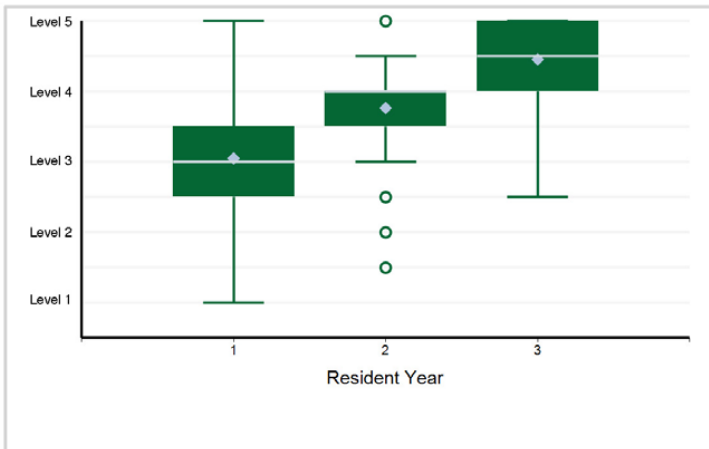

9. Systems-Based Practice - Systems-Based Practice 3: Physician Role in Health Care Systems

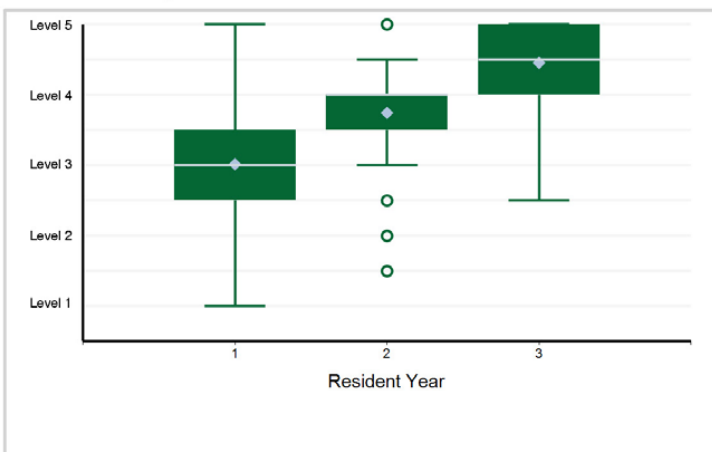

10. Practice-Based Learning and Improvement - Practice-Based Learning and Improvement 1: Evidence-Based and Informed Practice

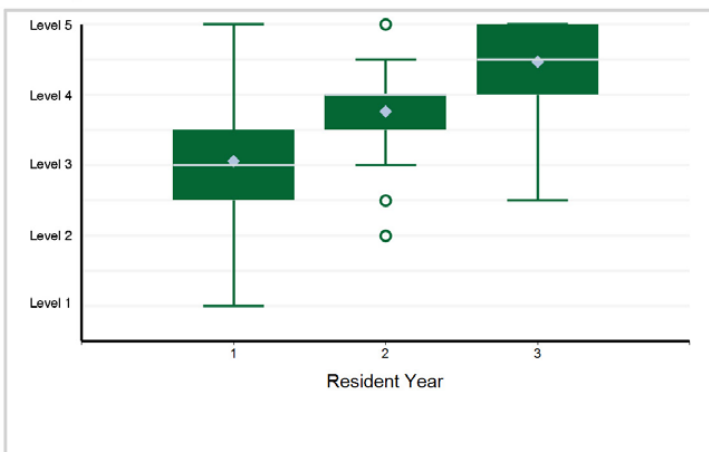

11. Practice-Based Learning and Improvement - Practice-Based Learning and Improvement 2: Reflective Practice and Commitment ...

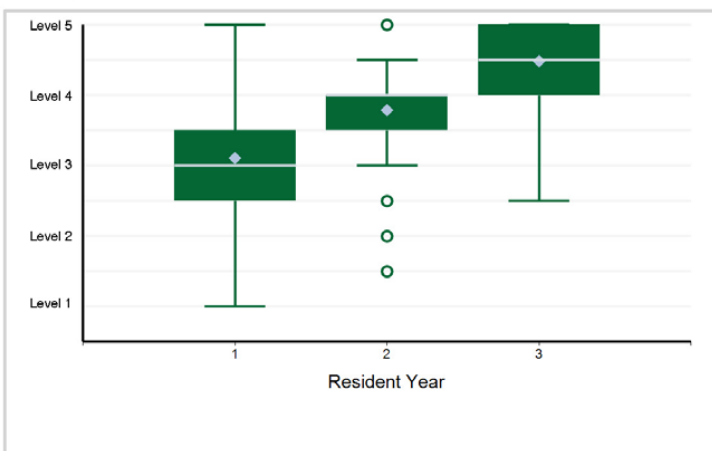

12. Professionalism - Professionalism 1: Professional Behavior and Ethical Principles

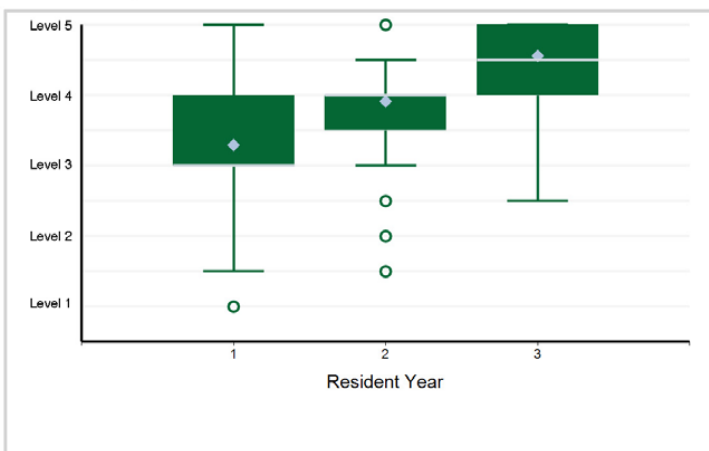

Specialty Box Plot Report - Milestone Evaluation by Resident Year: Year-End 2021-2022

SUBSPECIALTY: Cardiovascular Disease

13. Professionalism - Professionalism 2: Accountability

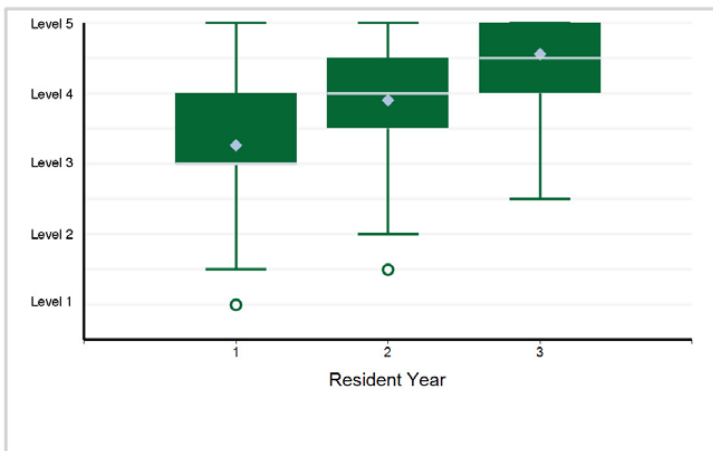

14. Professionalism - Professionalism 3: Self-Awareness and Well-Being

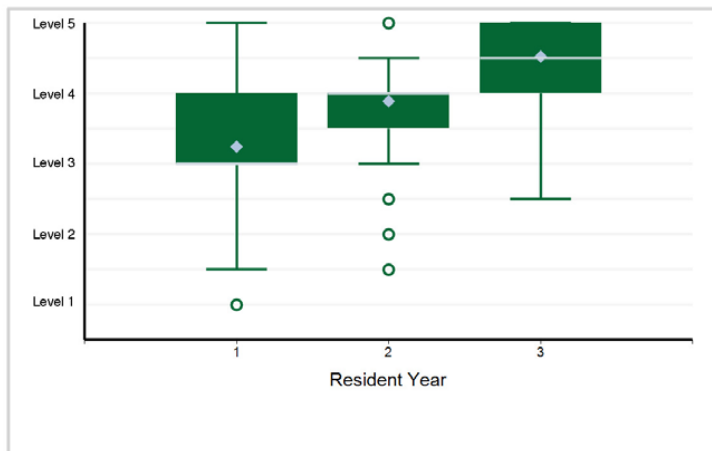

15. Interpersonal and Communication Skills - Interpersonal and Communication Skills 1: Patient and Family-Centered Communication

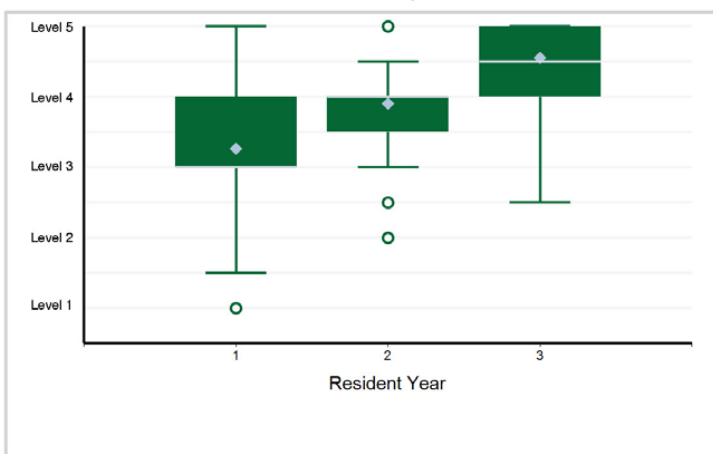

16. Interpersonal and Communication Skills - Interpersonal and Communication Skills 2: Interprofessional and Team Communication

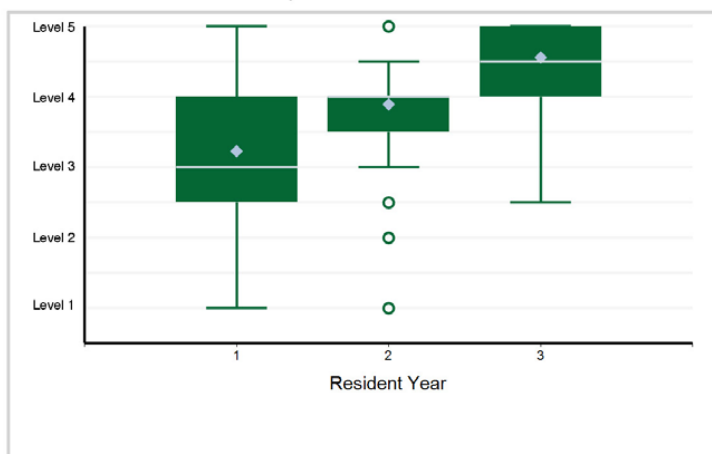

17. Interpersonal and Communication Skills - Interpersonal and Communication Skills 3: Communication within Health Care Systems

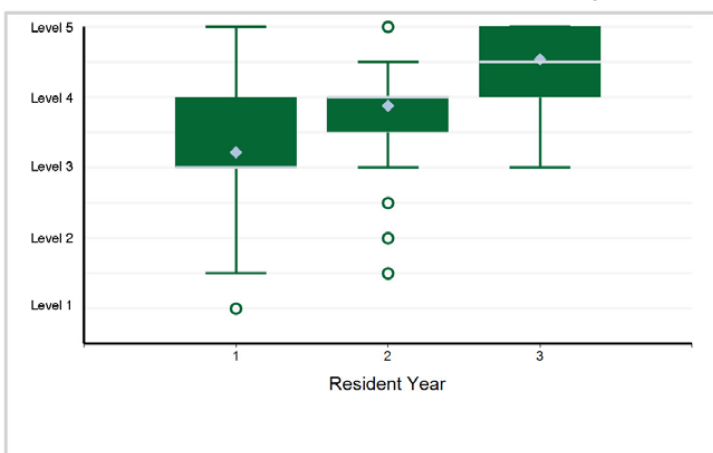

Specialty Box Plot Report - Milestone Evaluation by Resident Year: Year-End 2021-2022

TABLE 32: SUBSPECIALTY: **Clinical Cardiac Electrophysiology**

Resident Year	1	2	Total Residents*
# of Residents	174	135	309

*Note: There are 2 residents with an incomplete milestone evaluation that are excluded from the box plots below.

1. Patient Care - Patient Care 1: Atrial Fibrillation

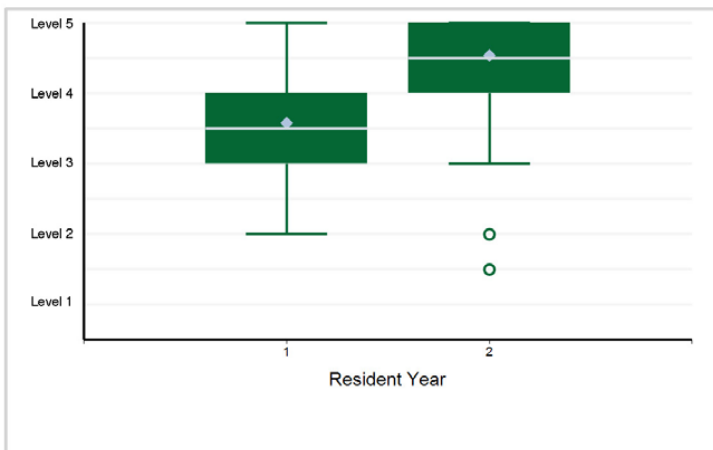

2. Patient Care - Patient Care 2: Supraventricular Tachycardia

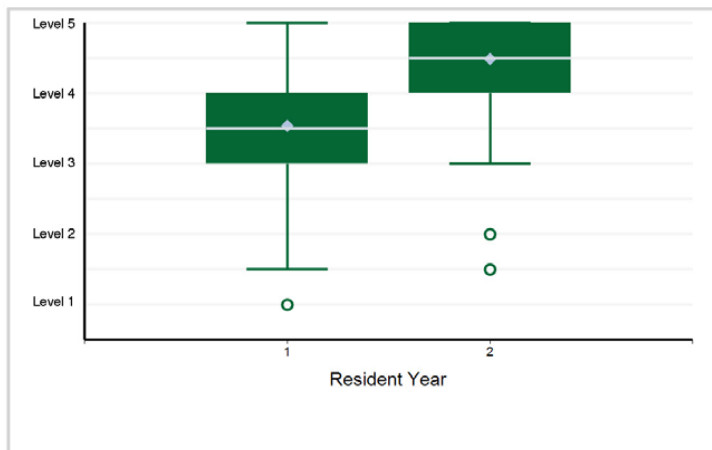

3. Patient Care - Patient Care 3: Bradycardia

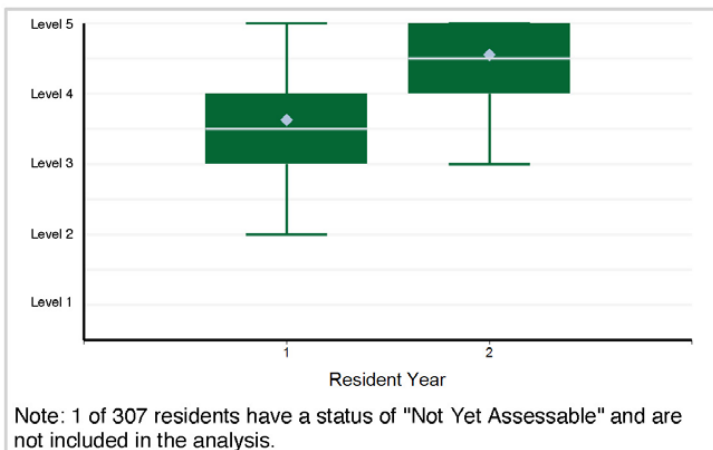

4. Patient Care - Patient Care 4: Syncope and Palpitations

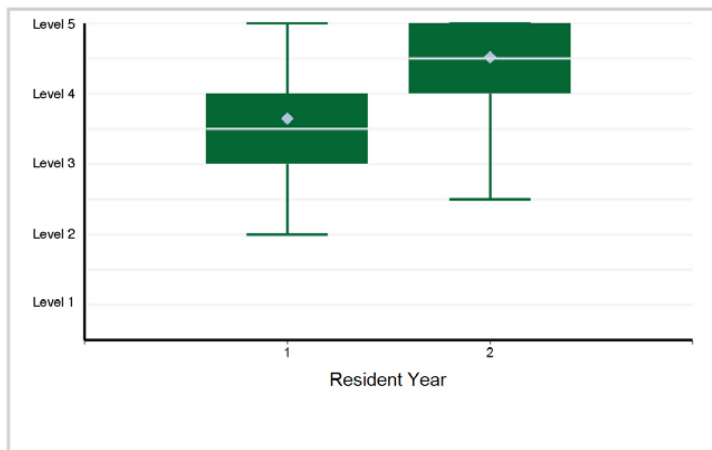

5. Patient Care - Patient Care 5: Ventricular Arrhythmias

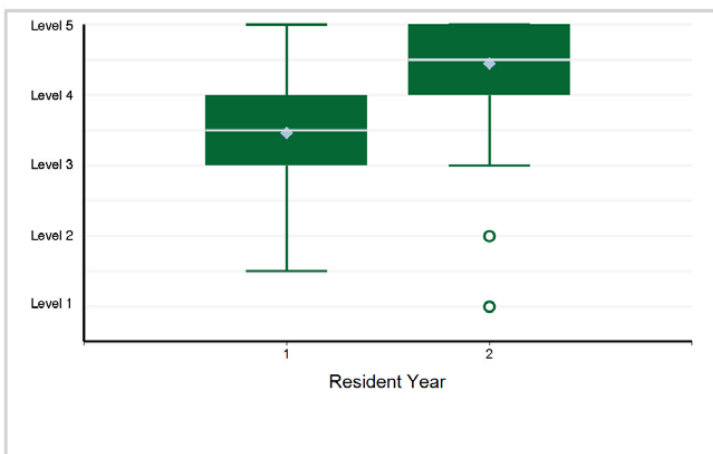

6. Patient Care - Patient Care 6: Sudden Cardiac Death

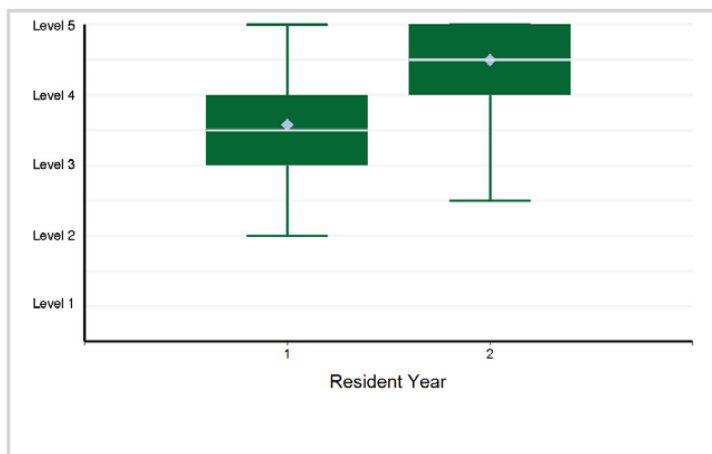

Specialty Box Plot Report - Milestone Evaluation by Resident Year: Year-End 2021-2022

SUBSPECIALTY: Clinical Cardiac Electrophysiology

7. Patient Care - Patient Care 7: Heart Failure

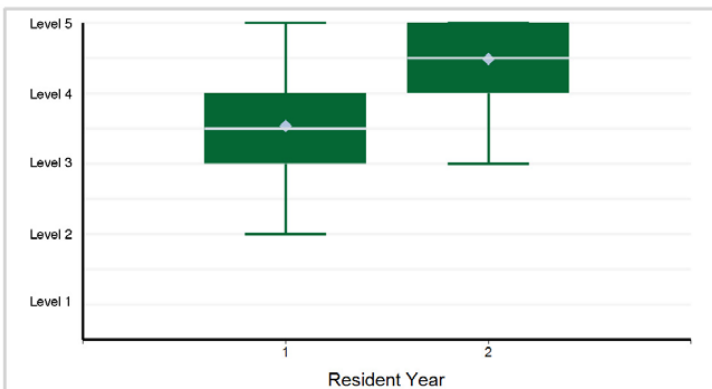

Note: 1 of 307 residents have a status of "Not Yet Assessable" and are not included in the analysis.

8. Patient Care - Patient Care 8: Procedural Complications

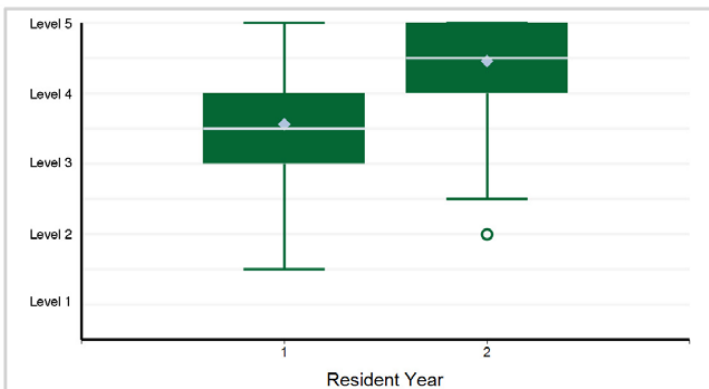

Note: 3 of 307 residents have a status of "Not Yet Assessable" and are not included in the analysis.

9. Patient Care - Patient Care 9: Ambulatory Care

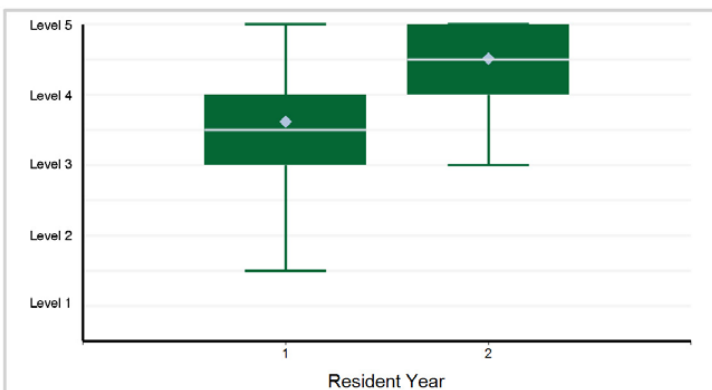

10. Medical Knowledge - Medical Knowledge 1: Arrhythmia Diagnosis and Interpretation

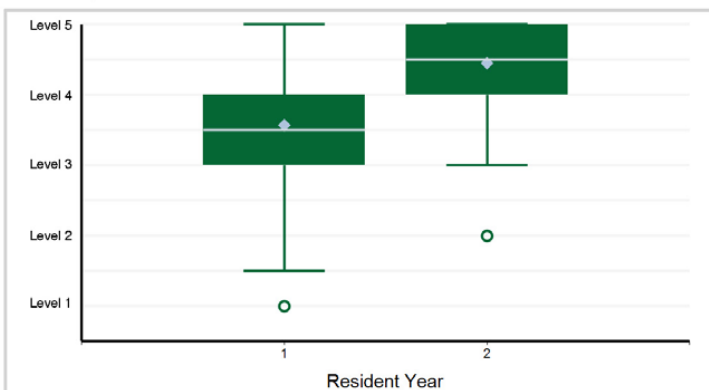

11. Medical Knowledge - Medical Knowledge 2: Critical Thinking and Decision Making

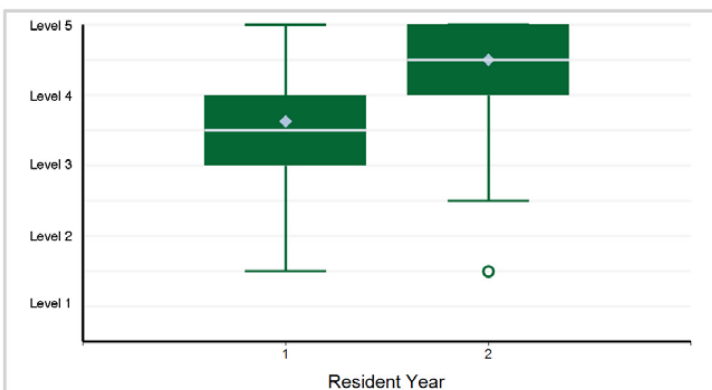

Note: 1 of 307 residents have a status of "Not Yet Assessable" and are not included in the analysis.

12. Medical Knowledge - Medical Knowledge 3: Electrophysiology (Cellular Physiology, Pharmacology, Mechanisms)

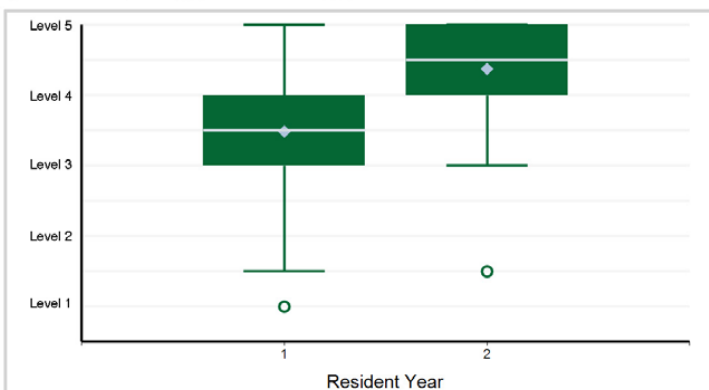

Note: 1 of 307 residents have a status of "Not Yet Assessable" and are not included in the analysis.

Specialty Box Plot Report - Milestone Evaluation by Resident Year: Year-End 2021-2022

SUBSPECIALTY: Clinical Cardiac Electrophysiology

13. Medical Knowledge - Medical Knowledge 4: Scholarly Activity

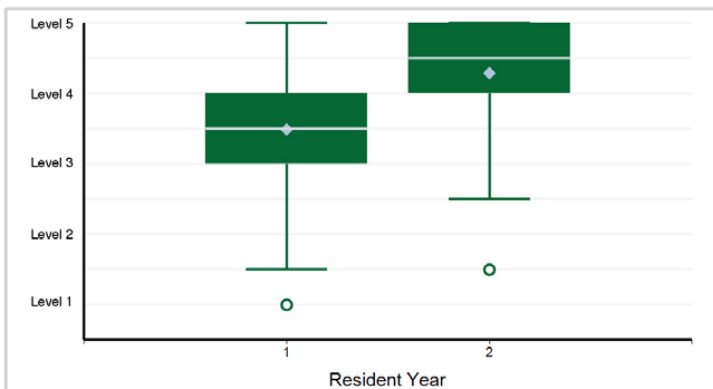

Note: 1 of 307 residents have a status of "Not Yet Assessable" and are not included in the analysis.

14. Systems-Based Practice - Systems-Based Practice 1: Patient Safety and Quality Improvement

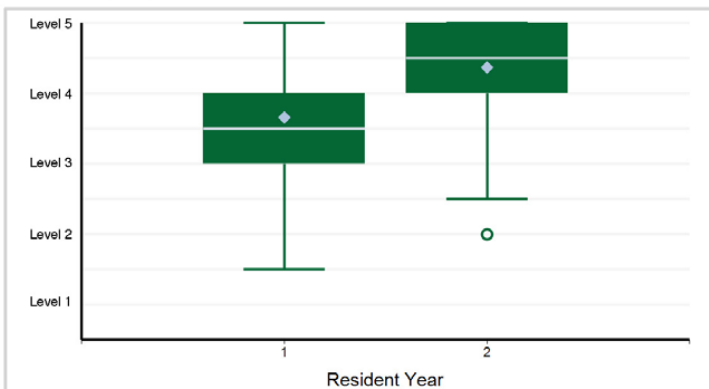

15. Systems-Based Practice - Systems-Based Practice 2: System Navigation for Patient-Centered Care

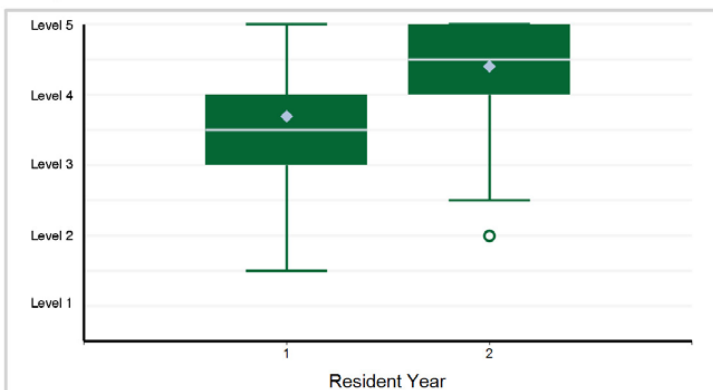

16. Systems-Based Practice - Systems-Based Practice 3: Physician Role in Health Care Systems

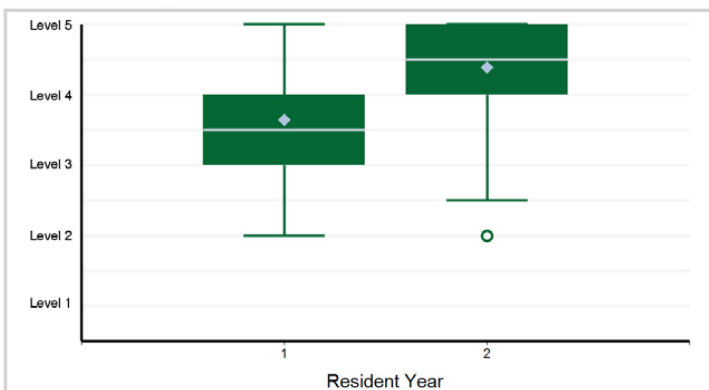

17. Practice-Based Learning and Improvement - Practice-Based Learning and Improvement 1: Evidence-Based and Informed Practice

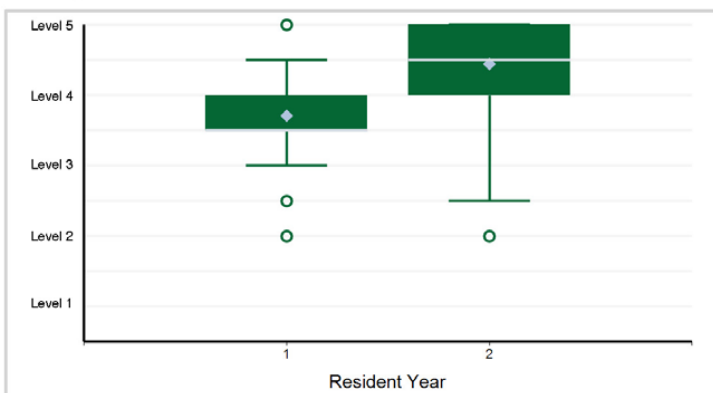

18. Practice-Based Learning and Improvement - Practice-Based Learning and Improvement 2: Reflective Practice and Commitment ...

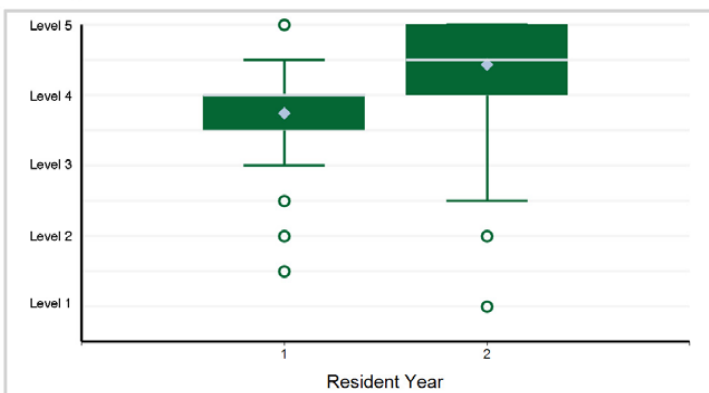

Specialty Box Plot Report - Milestone Evaluation by Resident Year: Year-End 2021-2022

SUBSPECIALTY: Clinical Cardiac Electrophysiology

19. Professionalism - Professionalism 1: Professional Behavior and Ethical Principles

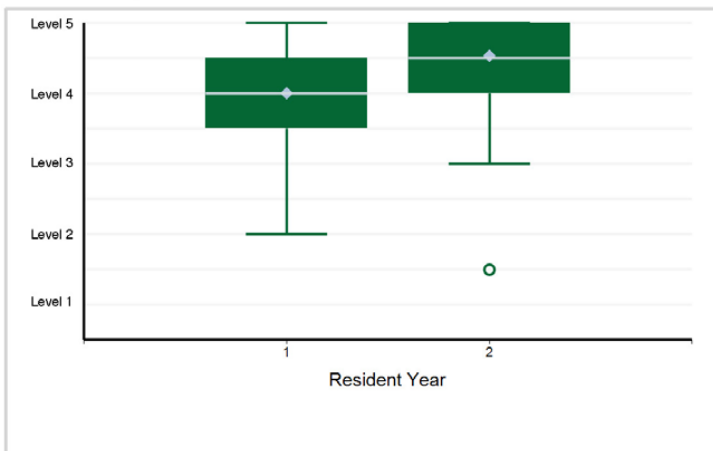

20. Professionalism - Professionalism 2: Accountability/Conscientiousness

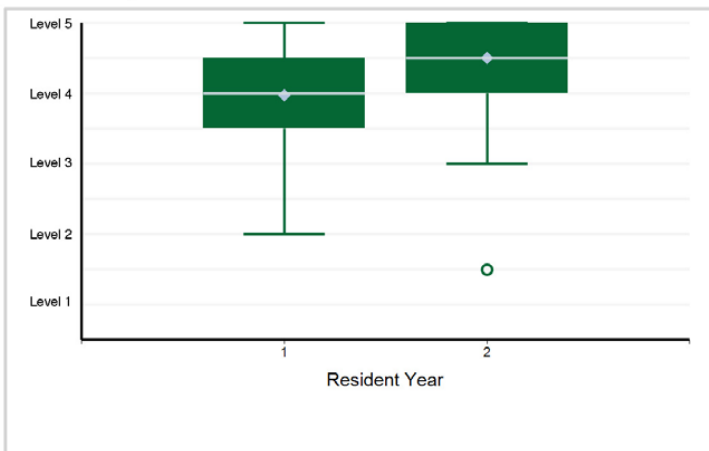

21. Professionalism - Professionalism 3: Self-Awareness and Well-Being

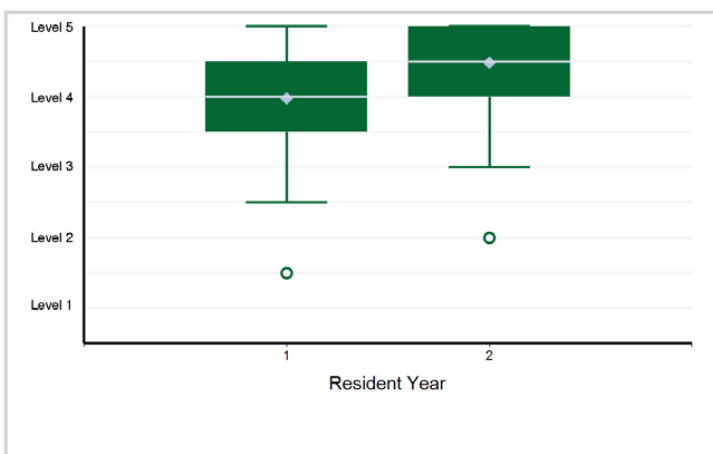

22. Interpersonal and Communication Skills - Interpersonal and Communication Skills 1: Patient- and Family-Centered Communication

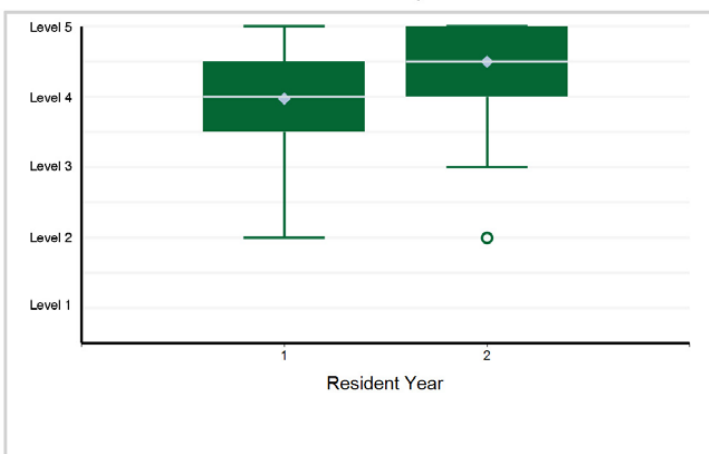

23. Interpersonal and Communication Skills - Interpersonal and Communication Skills 2: Interprofessional and Team Communication

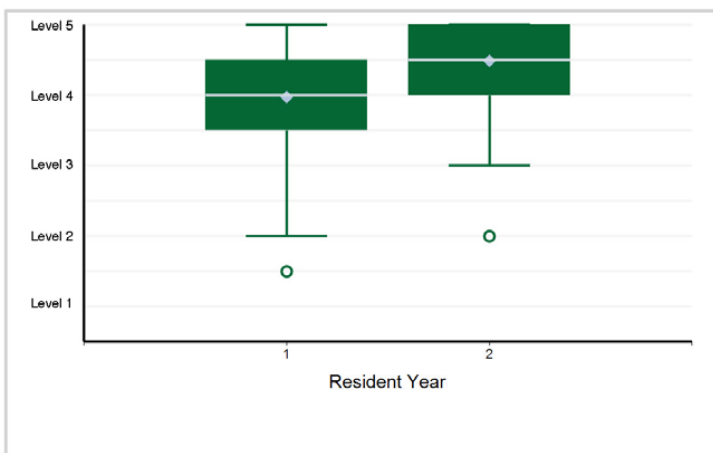

24. Interpersonal and Communication Skills - Interpersonal and Communication Skills 3: Communication within Health Care Systems

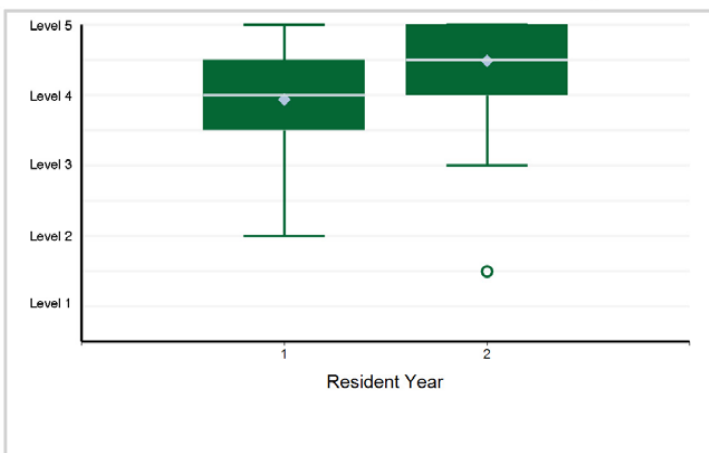

Specialty Box Plot Report - Milestone Evaluation by Resident Year: Year-End 2021-2022

TABLE 33: SUBSPECIALTY: **Clinical Informatics (multidisciplinary, Internal Medicine)**

Resident Year	1	2	Total Residents
# of Residents	31	19	50

1. Patient Care - Patient Care 1: Technology Assessment

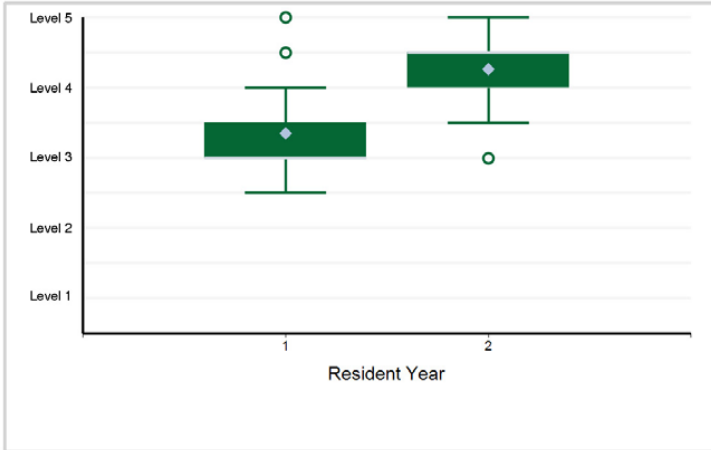

2. Patient Care - Patient Care 2: Clinical Decision Support Systems

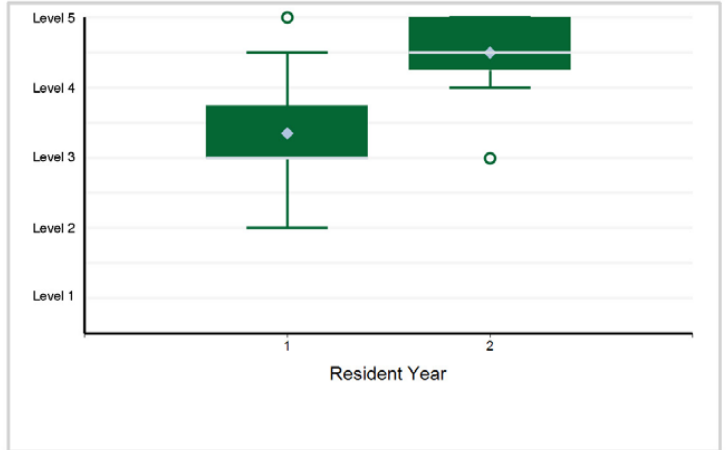

3. Patient Care - Patient Care 3: Impact of Clinical Informatics on Patient Care

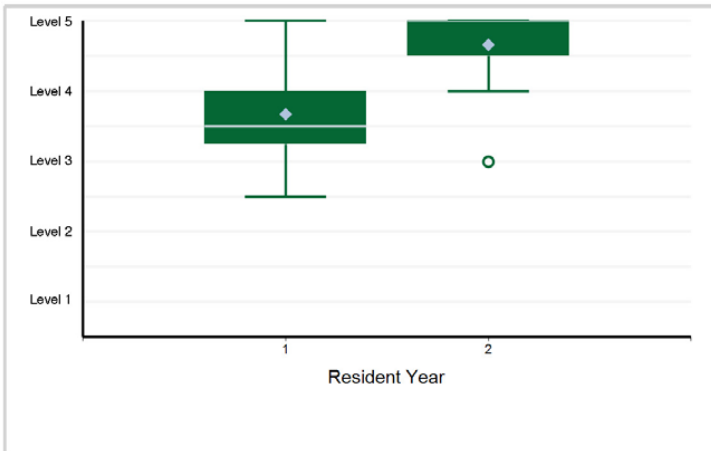

4. Patient Care - Patient Care 4: Project Management

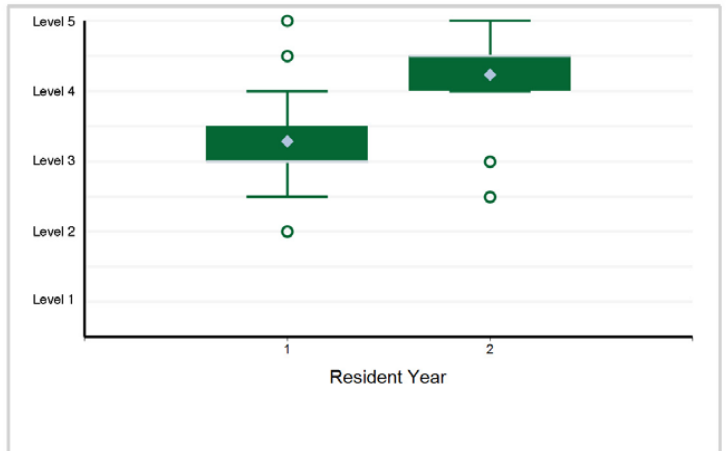

5. Patient Care - Patient Care 5: Information System Lifecycle

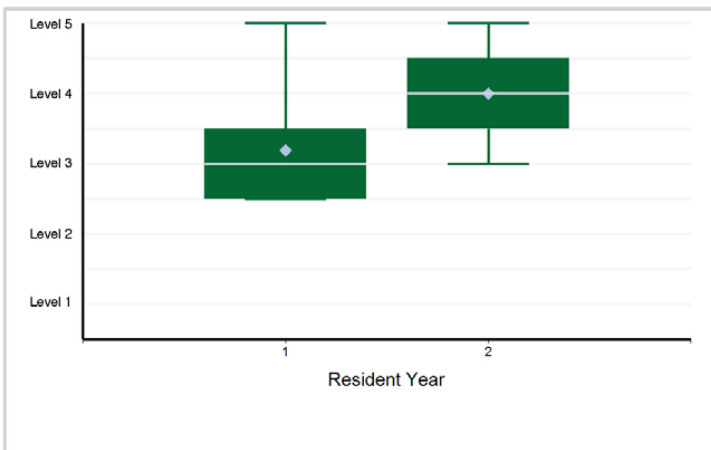

6. Patient Care - Patient Care 6: Assessing User Needs

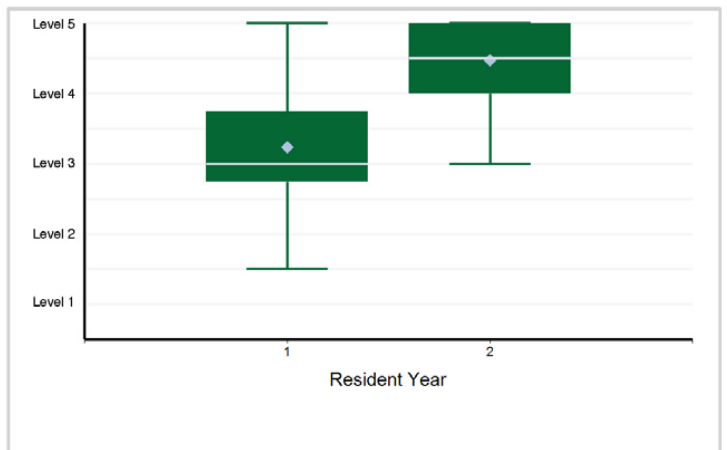

Specialty Box Plot Report - Milestone Evaluation by Resident Year: Year-End 2021-2022

SUBSPECIALTY: Clinical Informatics (multidisciplinary, Internal Medicine)

7. Medical Knowledge - Medical Knowledge 1: Clinical Informatics Fundamentals and Programming

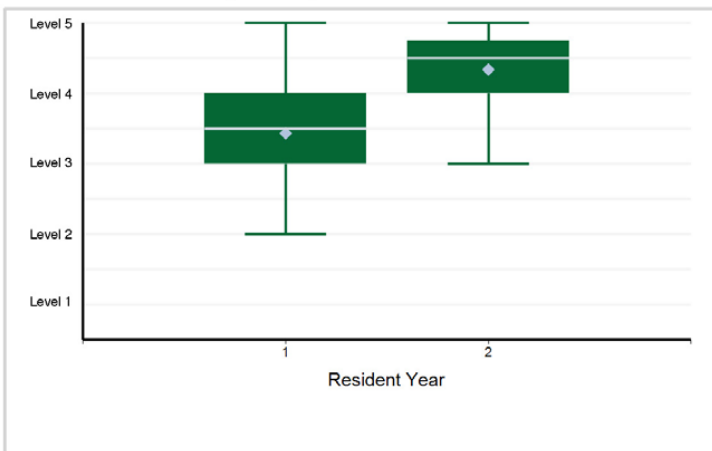

8. Medical Knowledge - Medical Knowledge 2: Leadership and Change Management

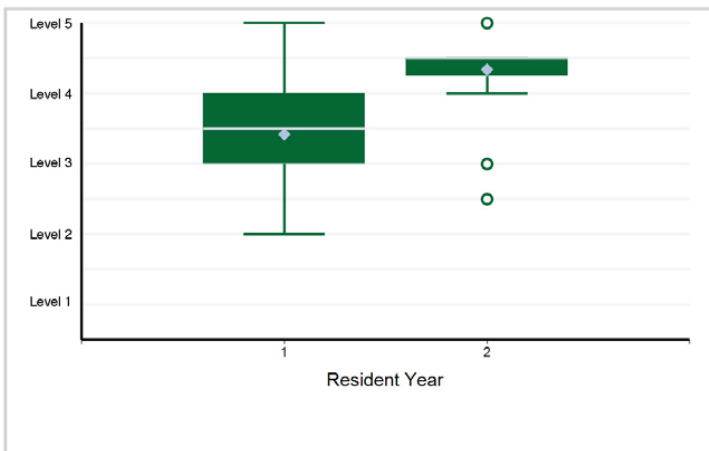

9. Systems-Based Practice - Systems-Based Practice 1: Patient Safety and Unintended Consequences

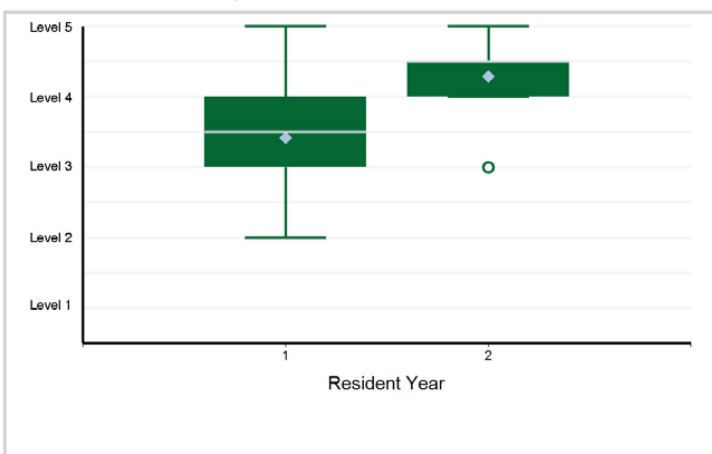

10. Systems-Based Practice - Systems-Based Practice 2: Resource Utilization

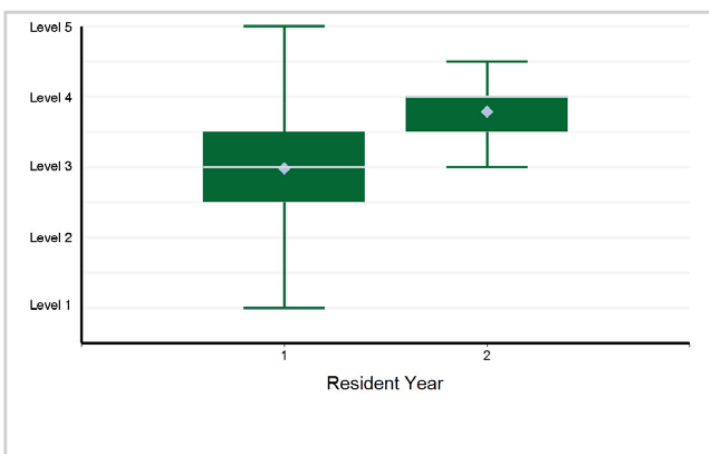

11. Systems-Based Practice - Systems-Based Practice 3: Workflow and Data Warehouse/Repository

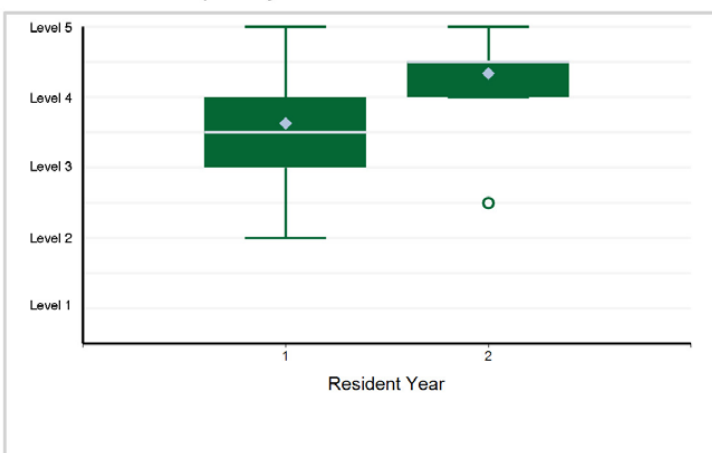

12. Practice-Based Learning and Improvement - Practice-Based Learning and Improvement 1: Recognition of ...

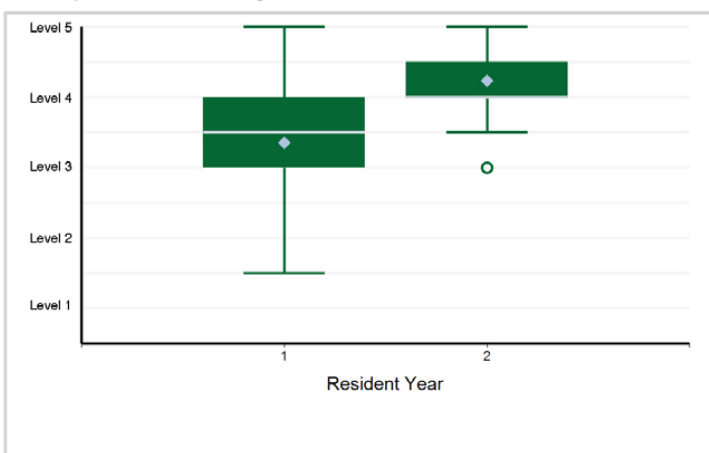

Specialty Box Plot Report - Milestone Evaluation by Resident Year: Year-End 2021-2022

SUBSPECIALTY: Clinical Informatics (multidisciplinary, Internal Medicine)

13. Practice-Based Learning and Improvement - Practice-Based Learning and Improvement 2: Scholarly Activity ...

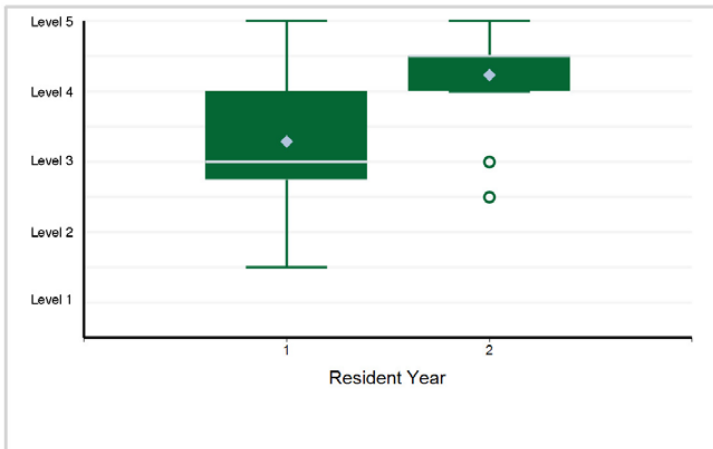

14. Professionalism - Professionalism 1: Professionalism — Demonstrates honesty, integrity, and ethical behavior

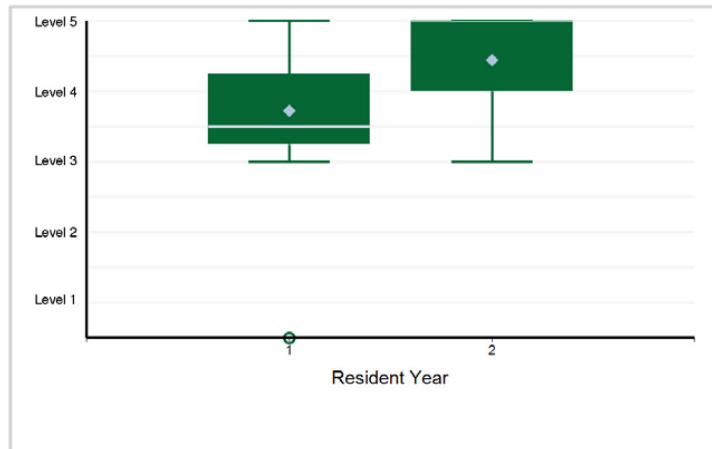

15. Professionalism - Professionalism 2: Professionalism — Demonstrates responsibility and follow-through on tasks

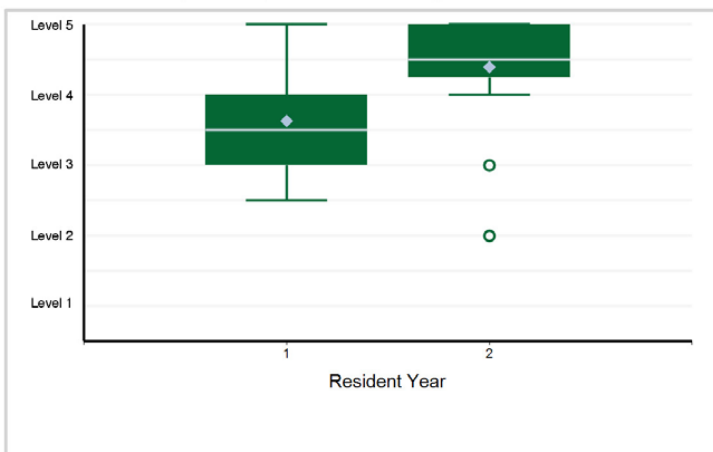

16. Professionalism - Professionalism 3: Professionalism — Gives and receives feedback

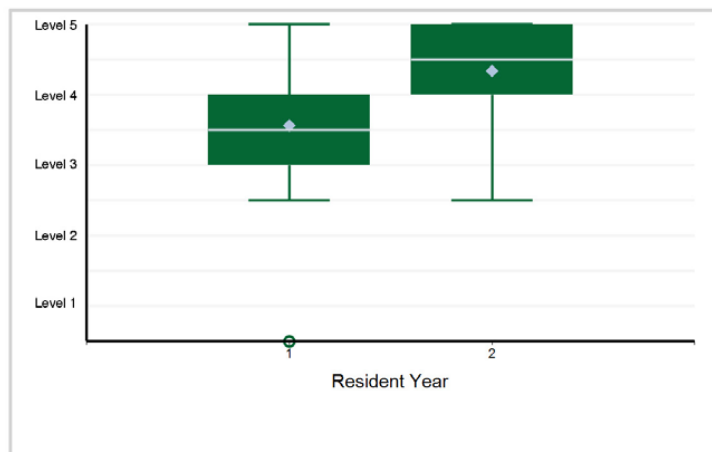

17. Professionalism - Professionalism 4: Professionalism — Demonstrates responsiveness and sensitivity to ...

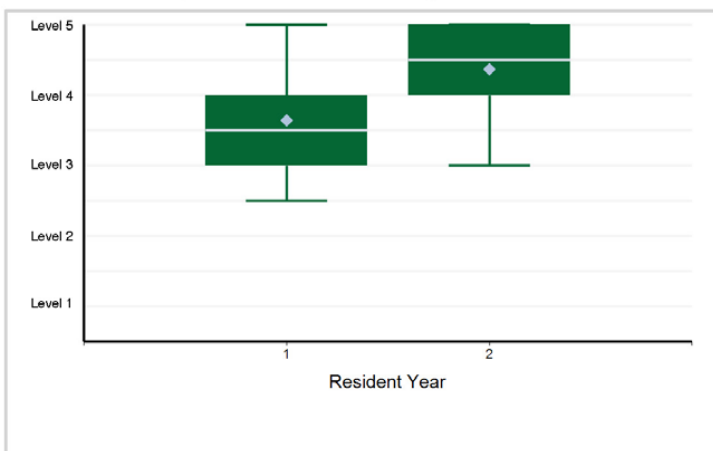

18. Professionalism - Professionalism 5: Professionalism — Understands and practices information security and privacy

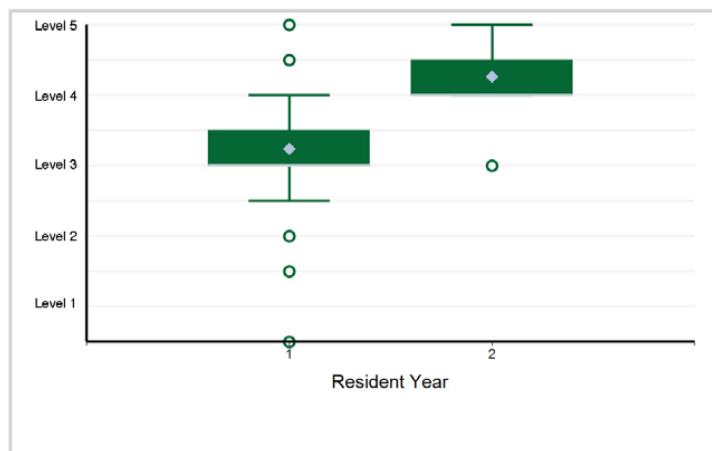

Specialty Box Plot Report - Milestone Evaluation by Resident Year: Year-End 2021-2022

SUBSPECIALTY: **Clinical Informatics (multidisciplinary, Internal Medicine)**

19. Interpersonal and Communication Skills - Interpersonal and Communication Skills 1: Effective Communications ...

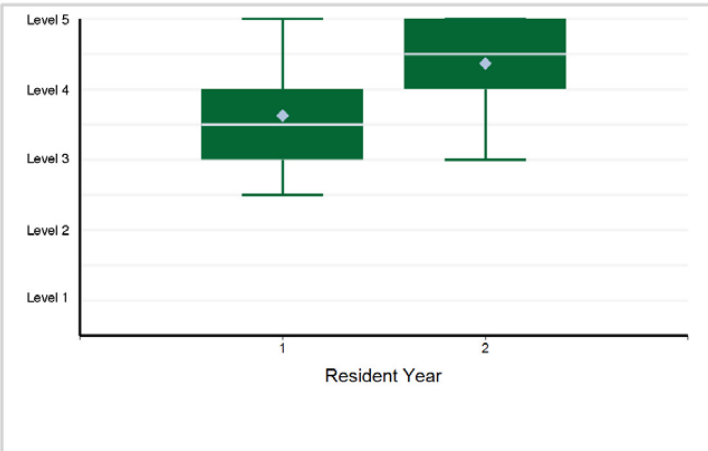

20. Interpersonal and Communication Skills - Interpersonal and Communication Skills 2: Communication with Patients and Families

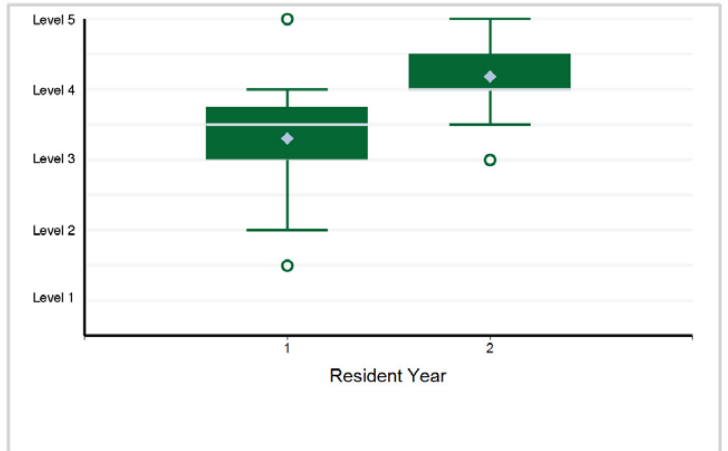

Specialty Box Plot Report - Milestone Evaluation by Resident Year: Year-End 2021-2022

TABLE 34: SUBSPECIALTY: **Critical Care Medicine**

Resident Year	1	2	Total Residents
# of Residents	186	136	322

1. Patient Care - Patient Care 1: History and Physical Examination

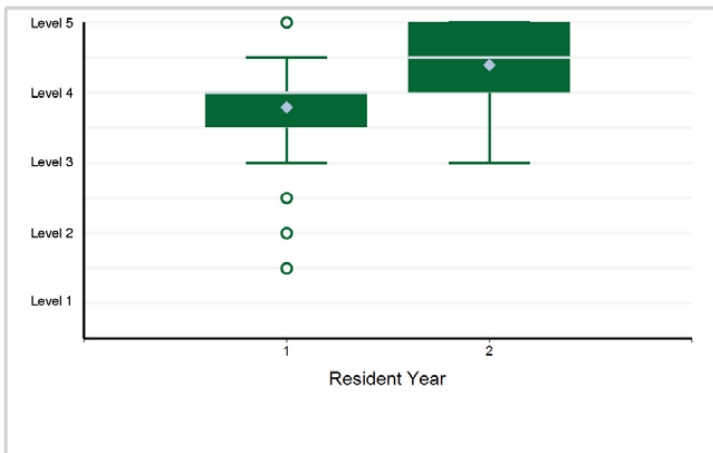

2. Patient Care - Patient Care 2: Disease Management in Critical Care

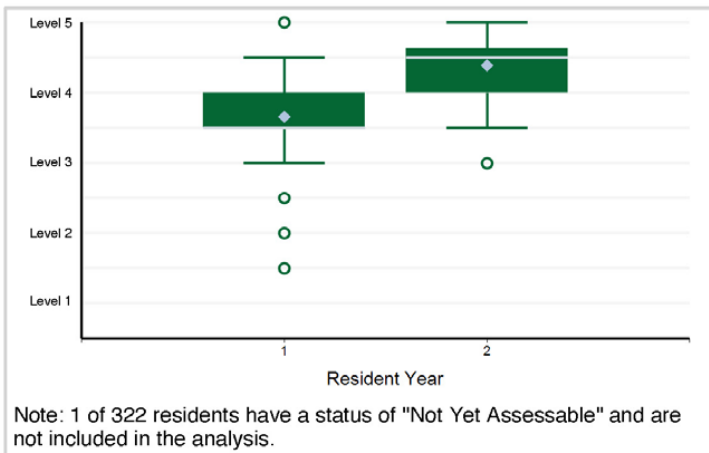

3. Patient Care - Patient Care 3: Pre-Procedure Assessment

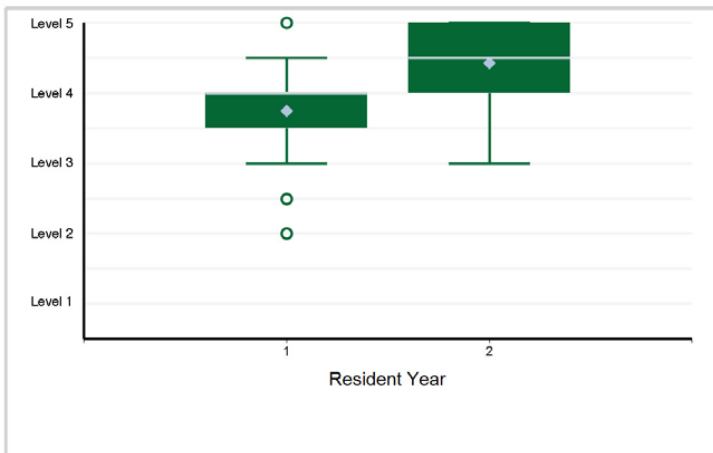

4. Patient Care - Patient Care 4: Procedures (Invasive and Non-Invasive)

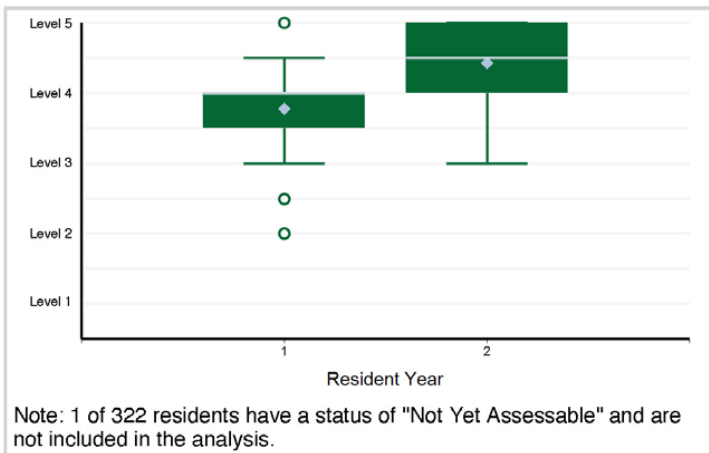

5. Medical Knowledge - Medical Knowledge 1: Clinical Reasoning

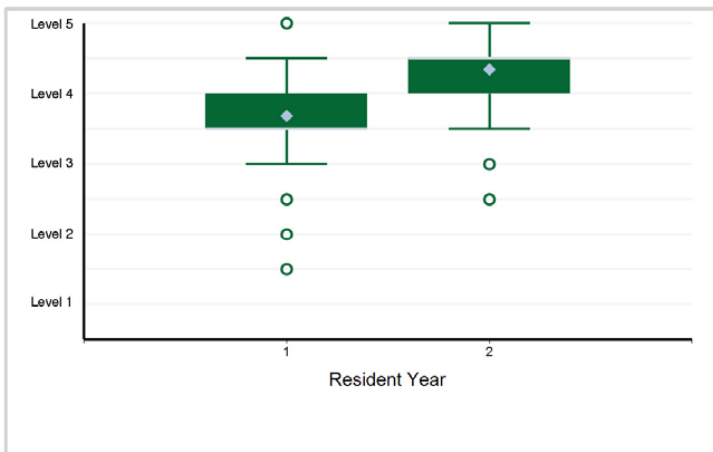

6. Medical Knowledge - Medical Knowledge 2: Scientific Knowledge of Disease and Therapeutics

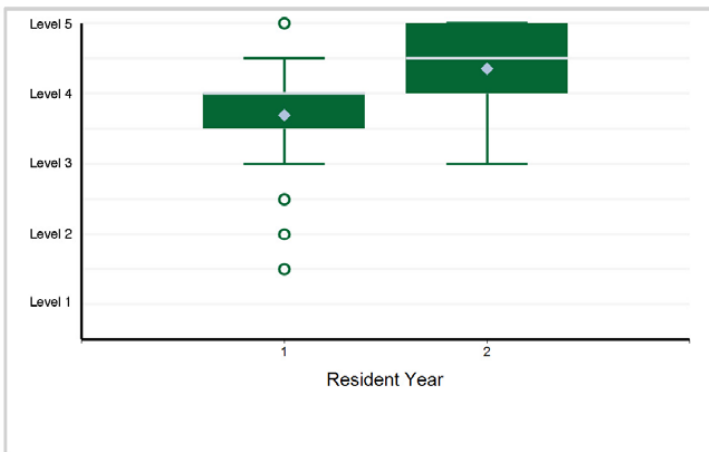

Specialty Box Plot Report - Milestone Evaluation by Resident Year: Year-End 2021-2022

SUBSPECIALTY: Critical Care Medicine

7. Systems-Based Practice - Systems-Based Practice 1: Patient Safety and Quality Improvement

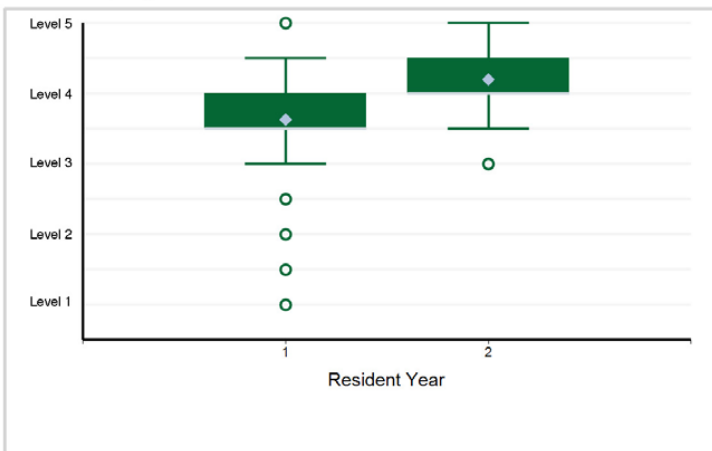

8. Systems-Based Practice - Systems-Based Practice 2: Coordination and Transition of Care

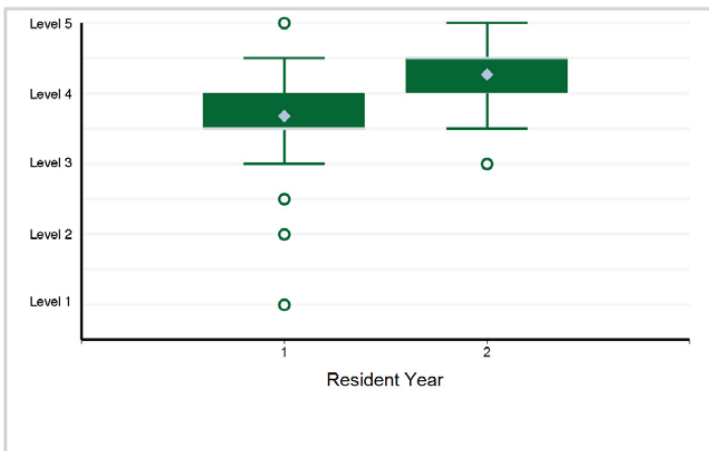

9. Systems-Based Practice - Systems-Based Practice 3: Population Health

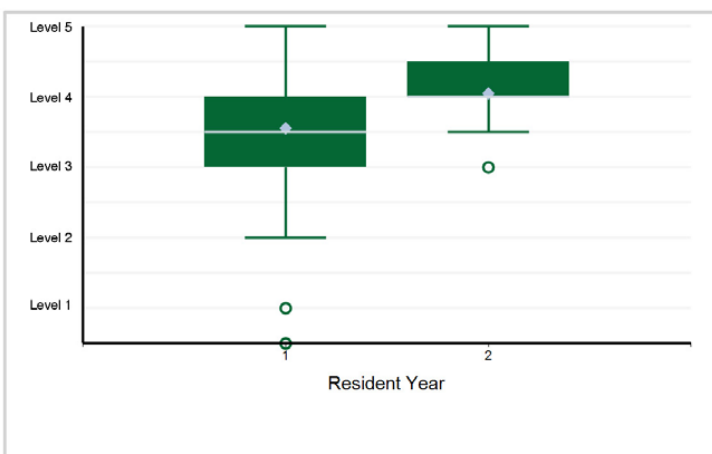

10. Systems-Based Practice - Systems-Based Practice 4: Physician Role in Health Care Systems

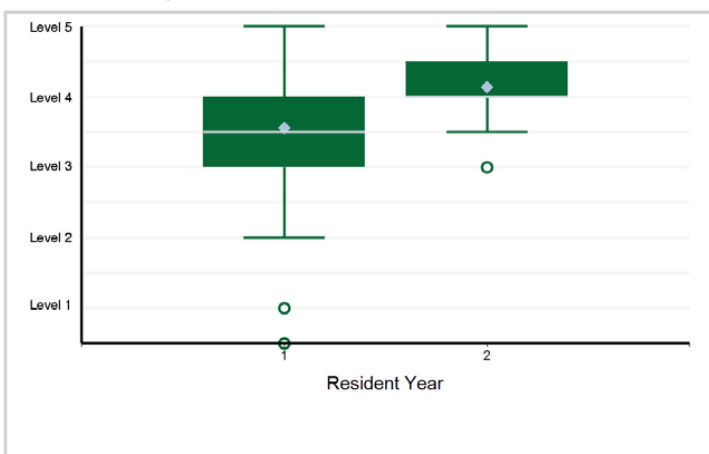

11. Practice-Based Learning and Improvement - Practice-Based Learning and Improvement 1: Evidence-Based and Informed Practice

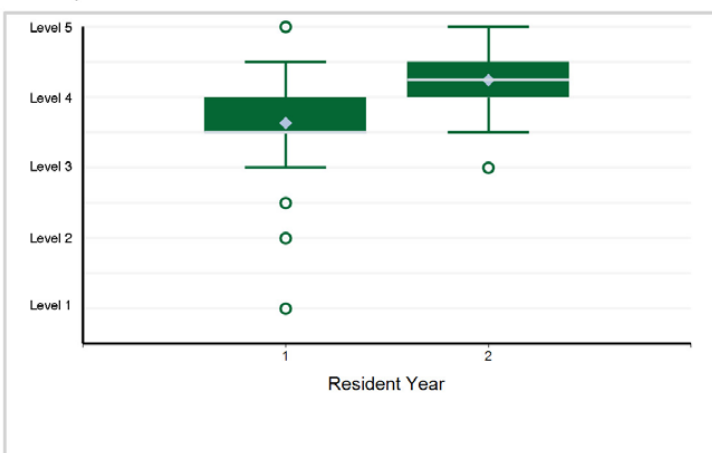

12. Practice-Based Learning and Improvement - Practice-Based Learning and Improvement 2: Reflective Practice and Commitment ...

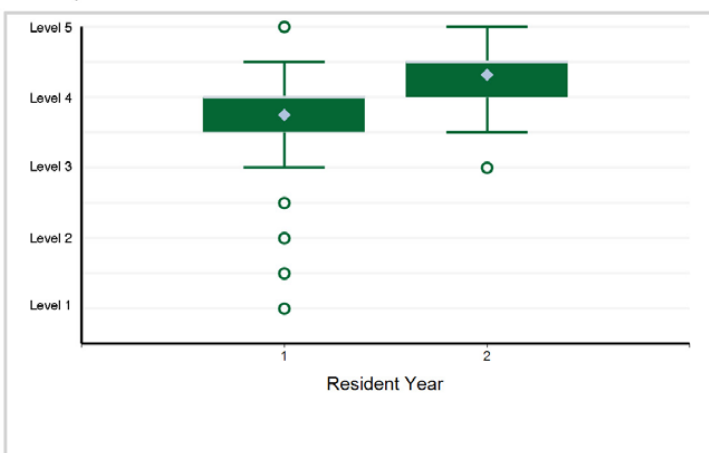

Specialty Box Plot Report - Milestone Evaluation by Resident Year: Year-End 2021-2022

SUBSPECIALTY: Critical Care Medicine

13. Professionalism - Professionalism 1: Professional Behavior and Ethical Principles

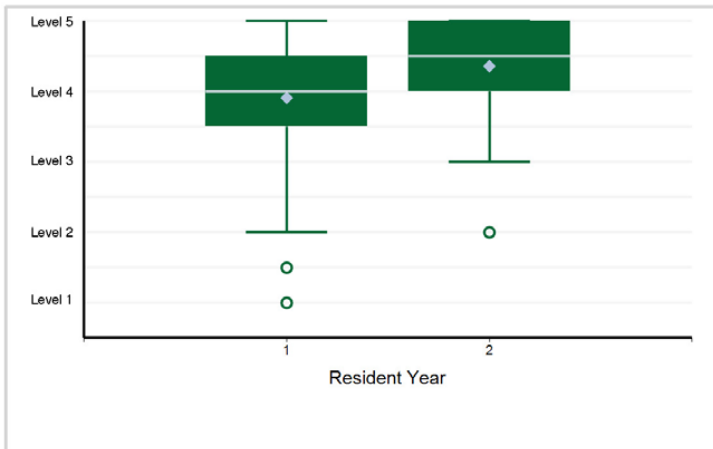

14. Professionalism - Professionalism 2: Accountability

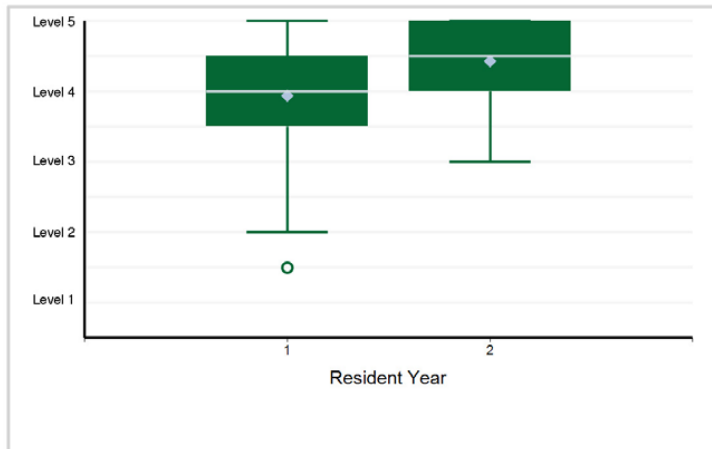

15. Professionalism - Professionalism 3: Well-Being and Resiliency

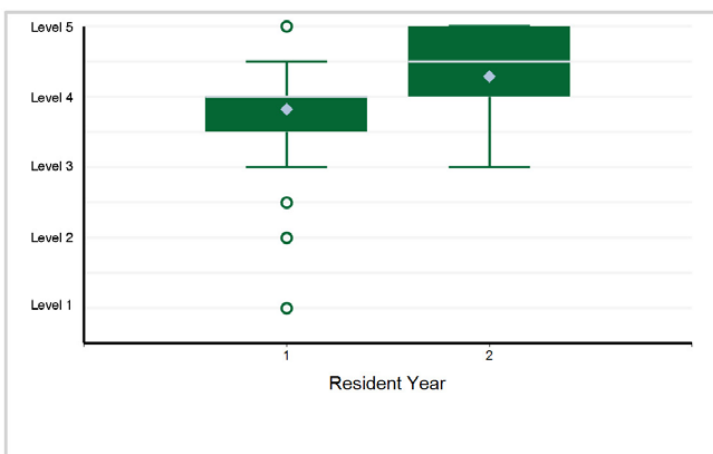

16. Interpersonal and Communication Skills - Interpersonal and Communication Skills 1: Patient- and Family-Centered Communication

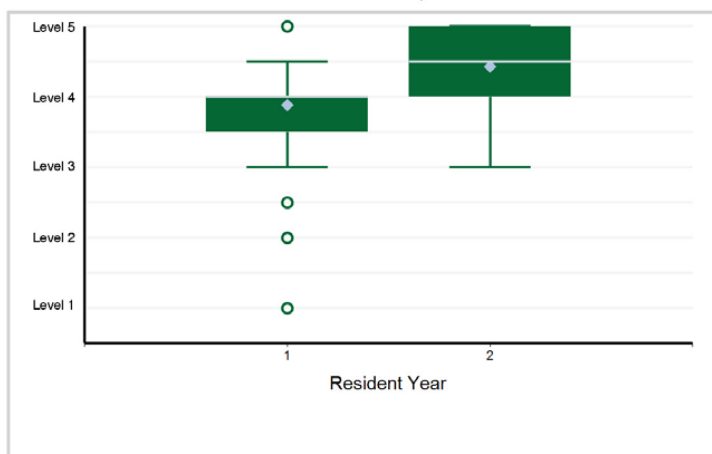

17. Interpersonal and Communication Skills - Interpersonal and Communication Skills 2: Interprofessional and Team Communication

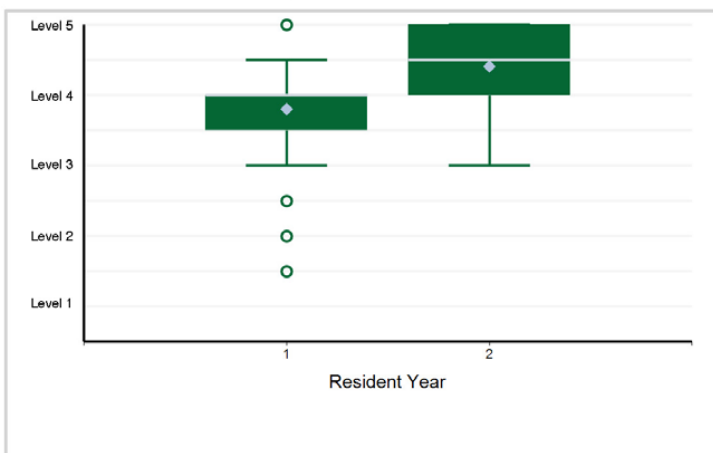

18. Interpersonal and Communication Skills - Interpersonal and Communication Skills 3: Communication within Health Care Systems

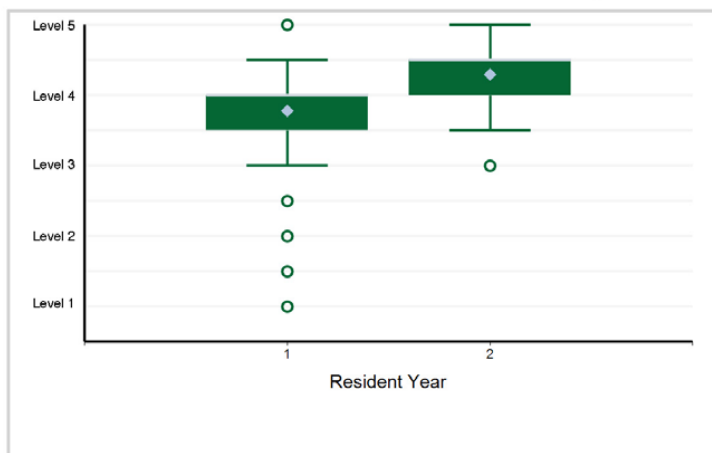

Specialty Box Plot Report - Milestone Evaluation by Resident Year: Year-End 2021-2022

SUBSPECIALTY: **Critical Care Medicine**

19. Interpersonal and Communication Skills - Interpersonal and Communication Skills 4: Complex Communication Around Serious ...

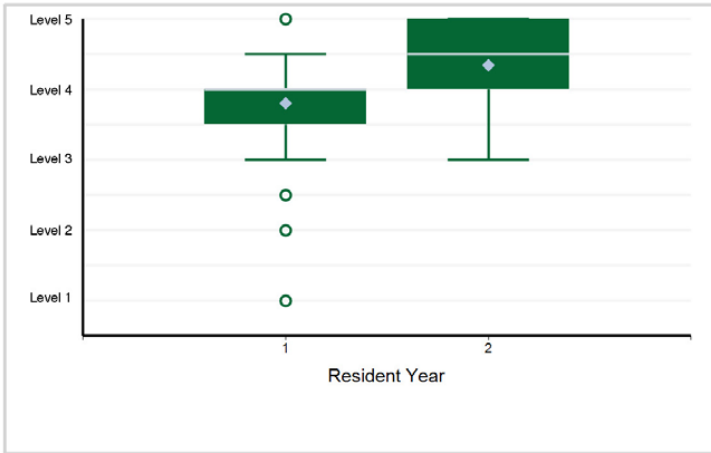

Specialty Box Plot Report - Milestone Evaluation by Resident Year: Year-End 2021-2022

TABLE 35: SUBSPECIALTY: **Endocrinology, Diabetes, and Metabolism**

Resident Year	1	2	Total Residents*
# of Residents	372	330	702

*Note: There are 6 residents with an incomplete milestone evaluation that are excluded from the box plots below.

1. Patient Care - Patient Care 1: History and Physical Exam

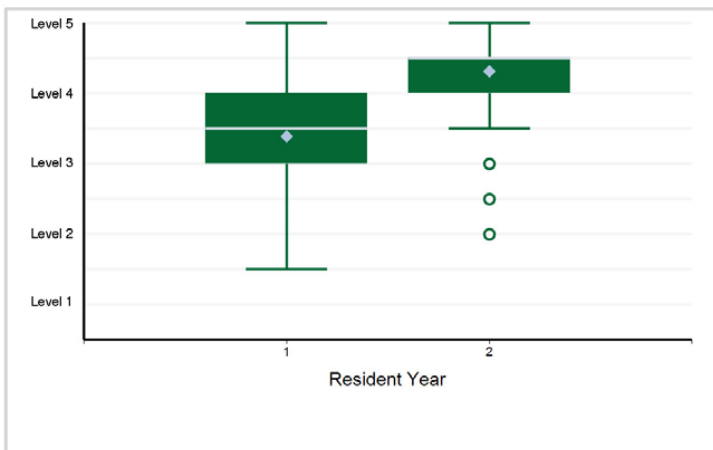

2. Patient Care - Patient Care 2: Diagnostic Testing, including Labs, Imaging, and Dynamic Testing

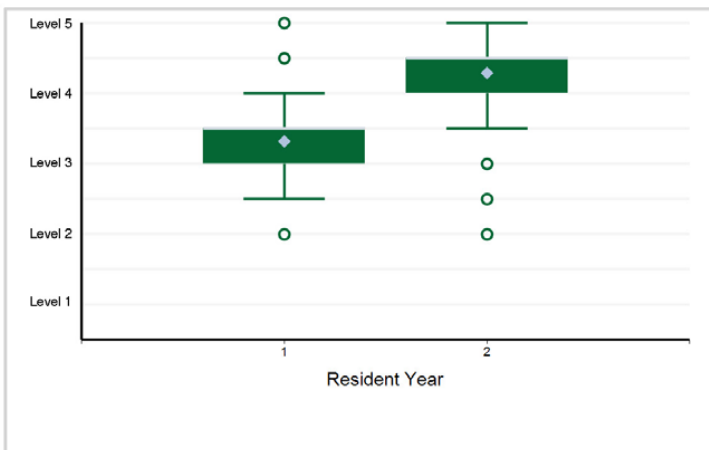

3. Patient Care - Patient Care 3: Therapeutics (Behavioral, Medications, Technology, Radiopharmaceuticals)

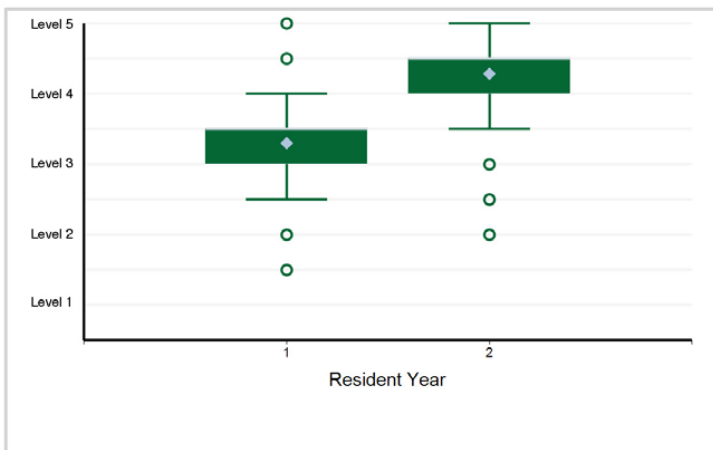

4. Patient Care - Patient Care 4: Procedures

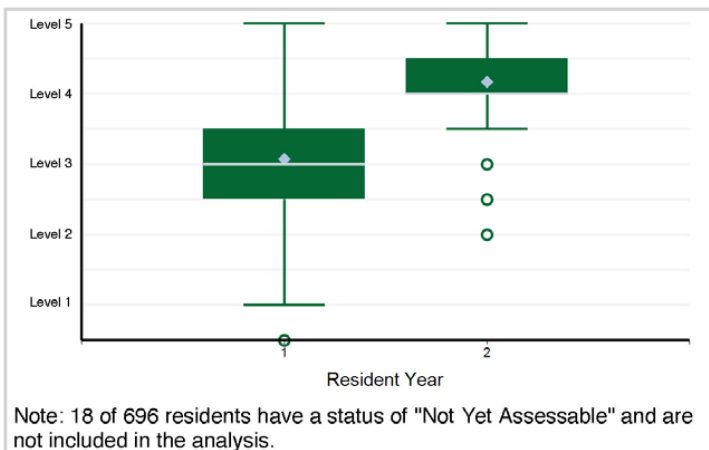

5. Patient Care - Patient Care 5: Provides Clinical Consultation

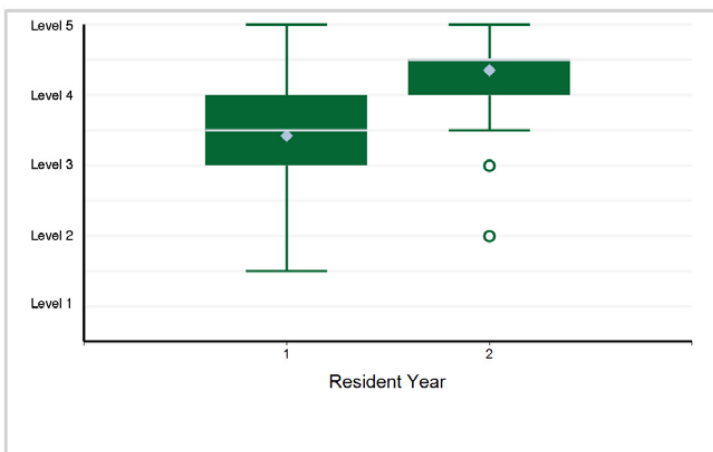

6. Patient Care - Patient Care 6: Requests Clinical Consultation

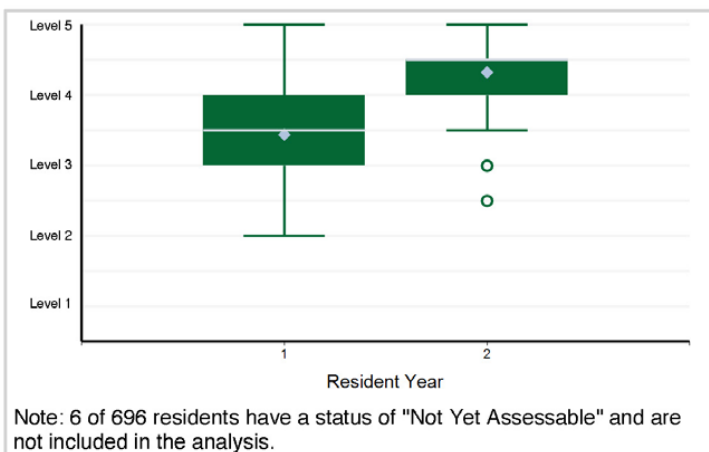

Specialty Box Plot Report - Milestone Evaluation by Resident Year: Year-End 2021-2022

SUBSPECIALTY: Endocrinology, Diabetes, and Metabolism

7. Medical Knowledge - Medical Knowledge 1: Integration of Pathophysiology and Clinical Reasoning

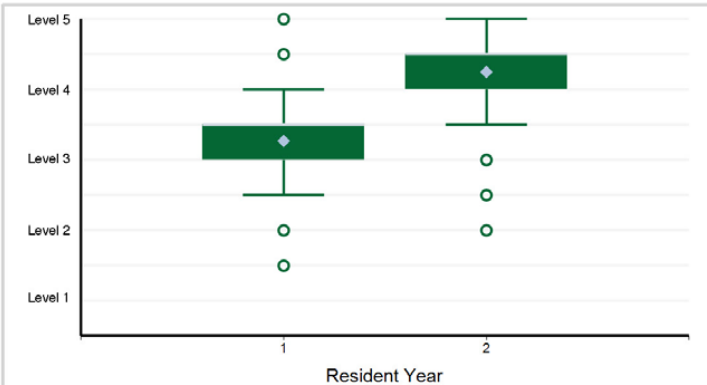

Note: 1 of 696 residents have a status of "Not Yet Assessable" and are not included in the analysis.

8. Medical Knowledge - Medical Knowledge 2: Scholarly Activity

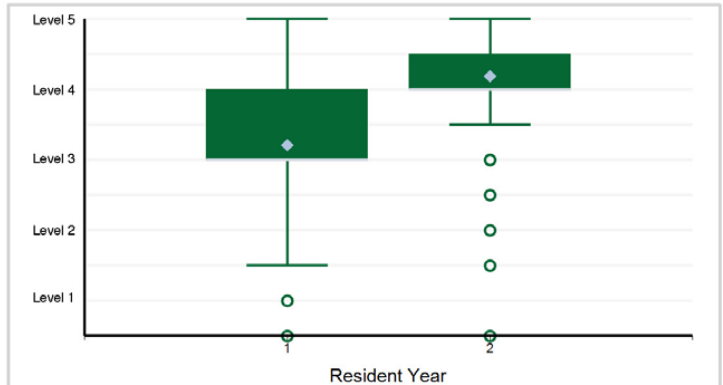

Note: 17 of 696 residents have a status of "Not Yet Assessable" and are not included in the analysis.

9. Systems-Based Practice - Systems-Based Practice 1: Patient Safety and Quality Improvement

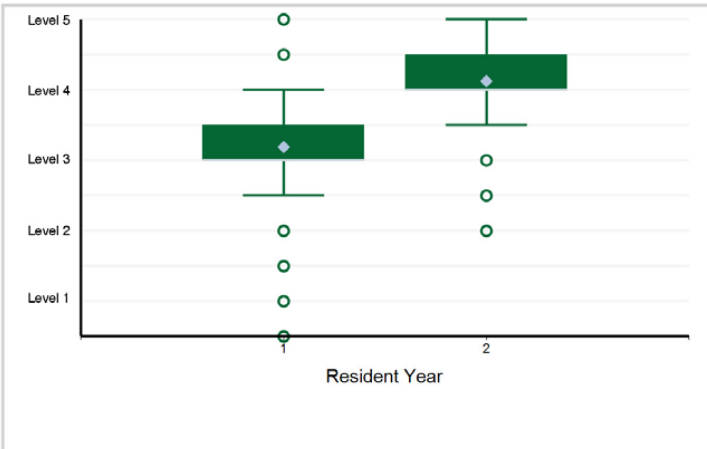

10. Systems-Based Practice - Systems-Based Practice 2: Coordination and Transitions of Care

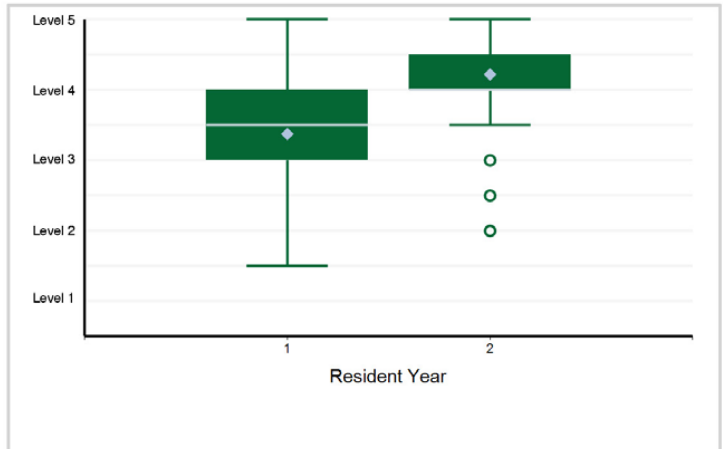

11. Systems-Based Practice - Systems-Based Practice 3: Physician Role in Health Care Systems and Community Health

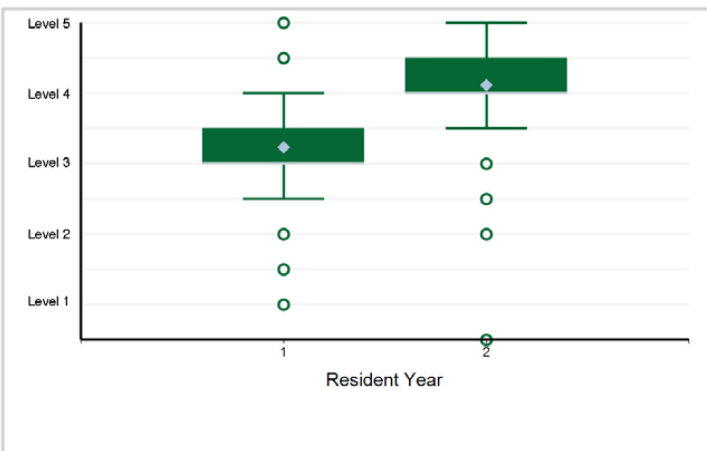

12. Practice-Based Learning and Improvement - Practice-Based Learning and Improvement 1: Evidence-Based and Informed Practice

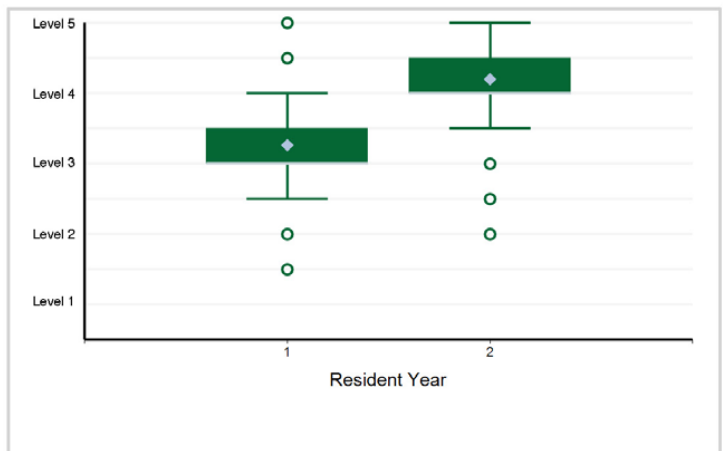

Specialty Box Plot Report - Milestone Evaluation by Resident Year: Year-End 2021-2022

SUBSPECIALTY: Endocrinology, Diabetes, and Metabolism

13. Practice-Based Learning and Improvement - Practice-Based Learning and Improvement 2: Reflective Practice and Commitment ...

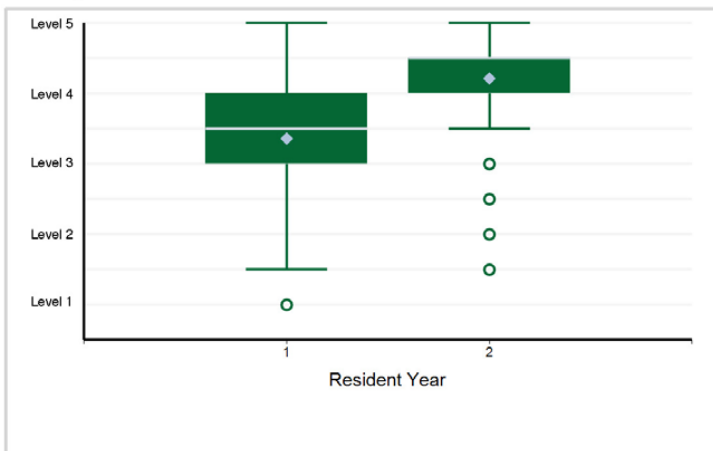

14. Professionalism - Professionalism 1: Professional Behavior

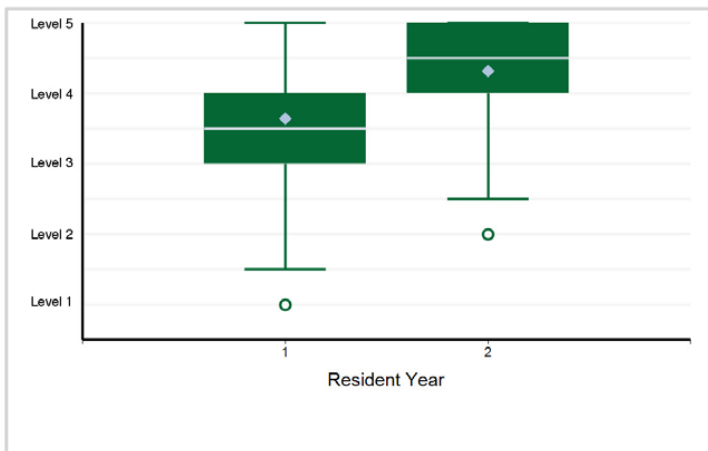

15. Professionalism - Professionalism 2: Accountability/Conscientiousness

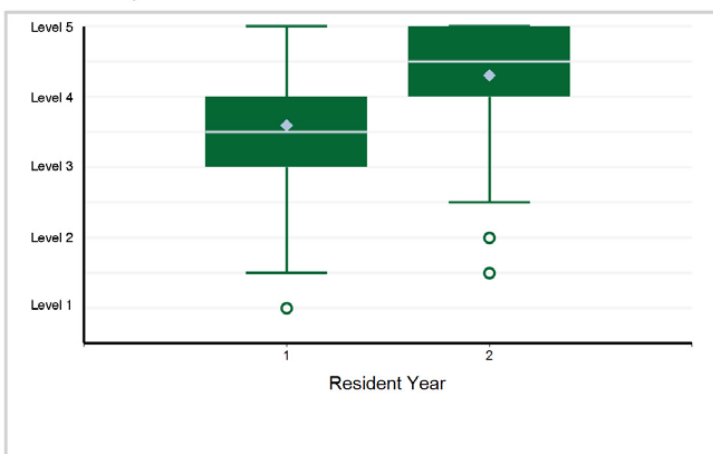

16. Professionalism - Professionalism 3: Personal and Professional Well-Being

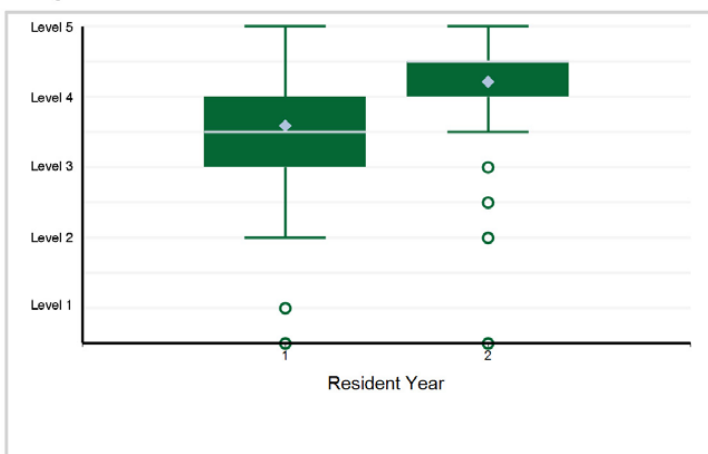

17. Interpersonal and Communication Skills - Interpersonal and Communication Skills 1: Patient- and Family-Centered Communication

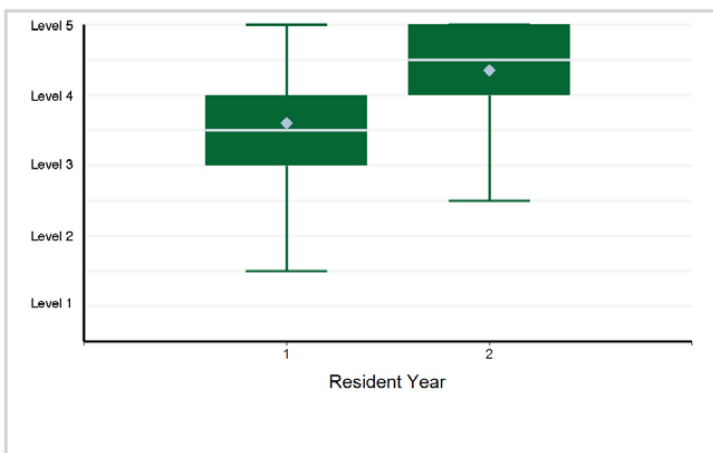

18. Interpersonal and Communication Skills - Interpersonal and Communication Skills 2: Interprofessional and Team Communication

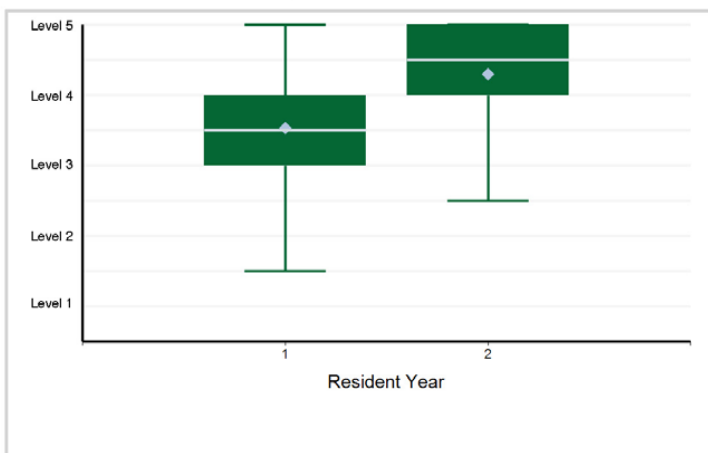

Specialty Box Plot Report - Milestone Evaluation by Resident Year: Year-End 2021-2022

SUBSPECIALTY: **Endocrinology, Diabetes, and Metabolism**

19. Interpersonal and Communication Skills - Interpersonal and Communication Skills 3: Communication within Health Care Systems

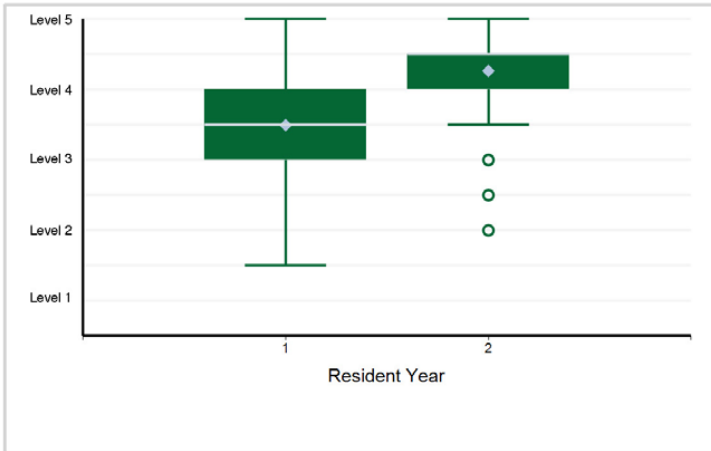

Specialty Box Plot Report - Milestone Evaluation by Resident Year: Year-End 2021-2022

TABLE 36: SUBSPECIALTY: **Gastroenterology**

Resident Year	1	2	3	Total Residents*
# of Residents	662	631	600	1,893

*Note: There are 5 residents with an incomplete milestone evaluation that are excluded from the box plots below.

1. Patient Care - Patient Care 1: Data Gathering and Non-Procedural Diagnostic Testing

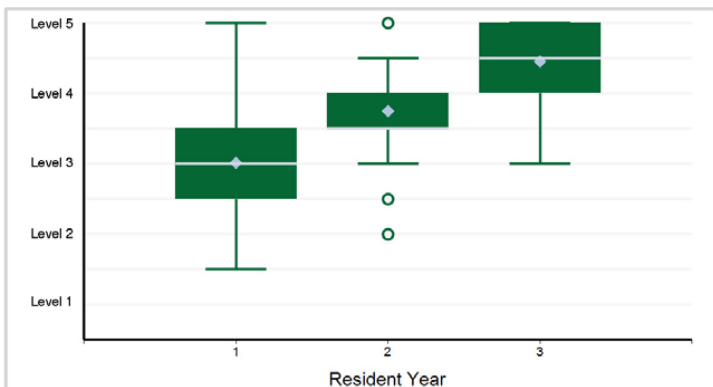

Note: 2 of 1,888 residents have a status of "Not Yet Assessable" and are not included in the analysis.

2. Patient Care - Patient Care 2: Patient Management in Gastrointestinal and Liver Disease

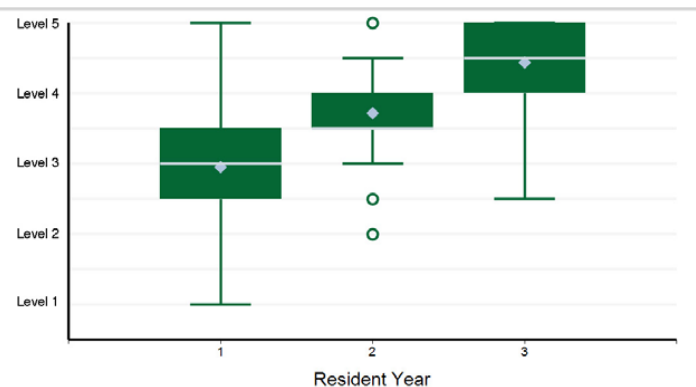

Note: 2 of 1,888 residents have a status of "Not Yet Assessable" and are not included in the analysis.

3. Patient Care - Patient Care 3: Procedures Cognitive Components

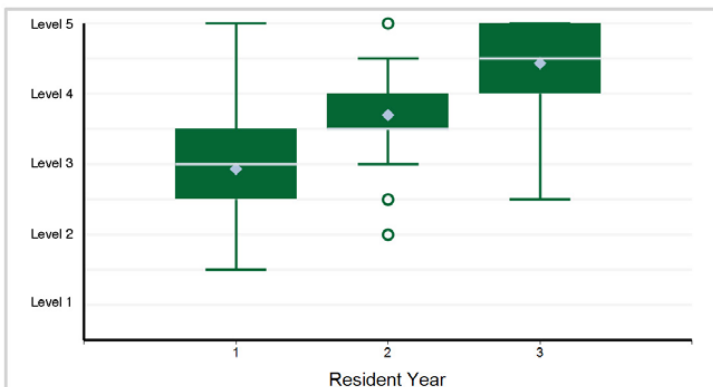

Note: 3 of 1,888 residents have a status of "Not Yet Assessable" and are not included in the analysis.

4. Patient Care - Patient Care 4: Procedures: Technical Components

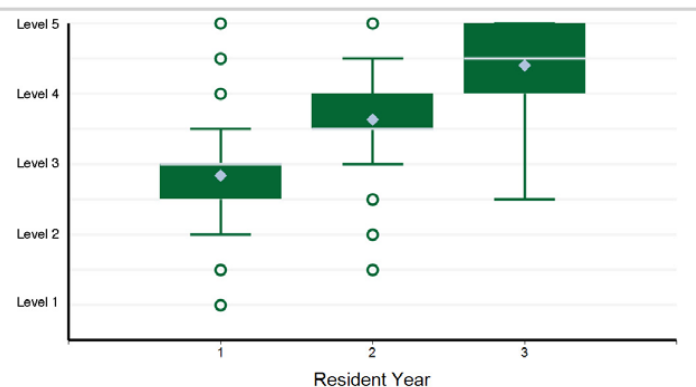

Note: 6 of 1,888 residents have a status of "Not Yet Assessable" and are not included in the analysis.

5. Medical Knowledge - Medical Knowledge 1: Clinical Knowledge of Gastrointestinal and Liver Diseases (Non-Procedural)

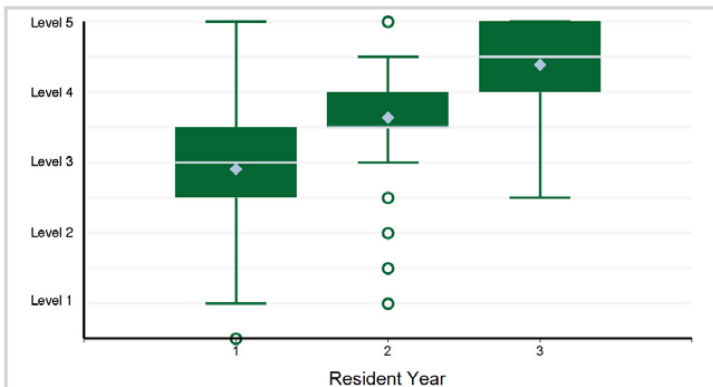

Note: 1 of 1,888 residents have a status of "Not Yet Assessable" and are not included in the analysis.

6. Medical Knowledge - Medical Knowledge 2: Clinical Reasoning

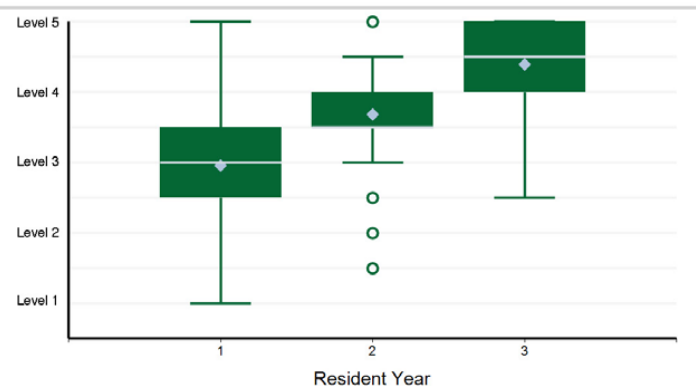

Note: 1 of 1,888 residents have a status of "Not Yet Assessable" and are not included in the analysis.

Specialty Box Plot Report - Milestone Evaluation by Resident Year: Year-End 2021-2022

SUBSPECIALTY: Gastroenterology

7. Systems-Based Practice - Systems-Based Practice 1: Patient Safety and Quality Improvement

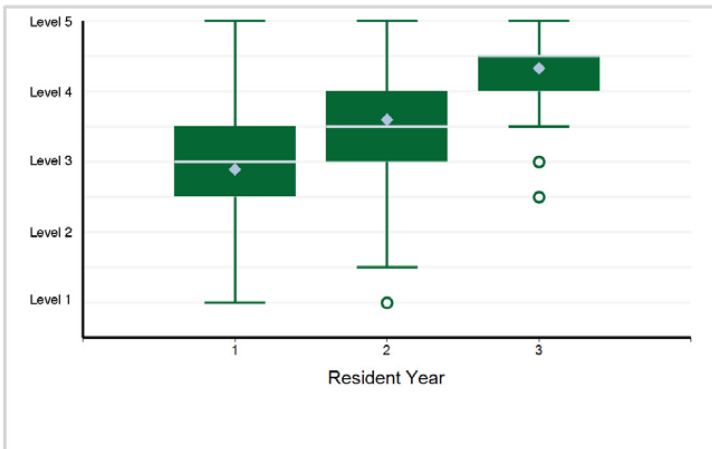

8. Systems-Based Practice - Systems-Based Practice 2: System Navigation for Patient-Centered Care

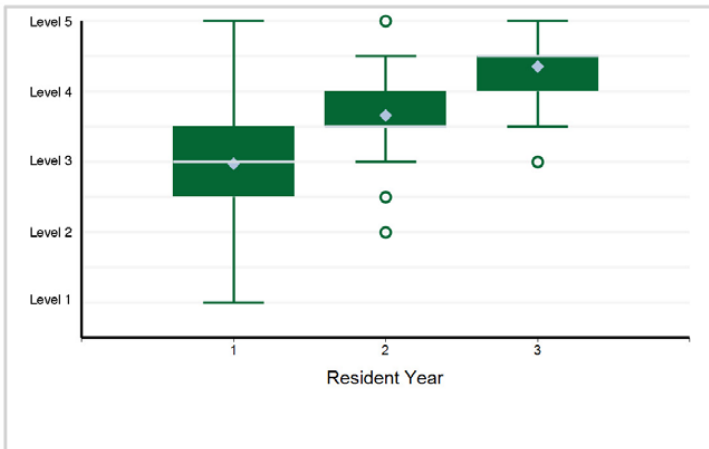

9. Systems-Based Practice - Systems-Based Practice 3: Physician Role in Health Care Systems

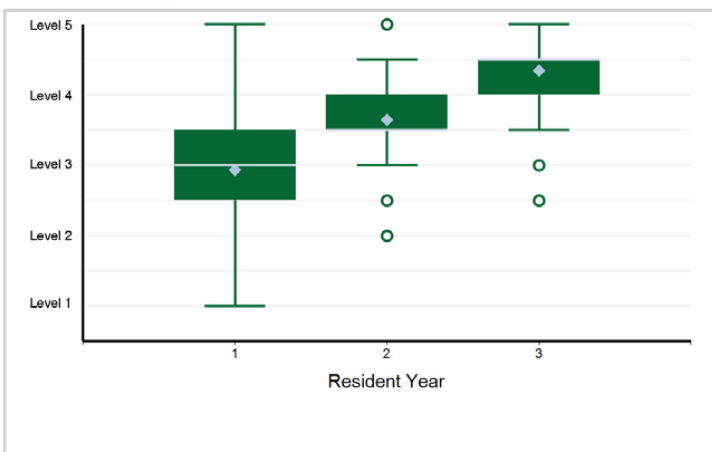

10. Practice-Based Learning and Improvement - Practice-Based Learning and Improvement 1: Evidence-Based and Informed Practice

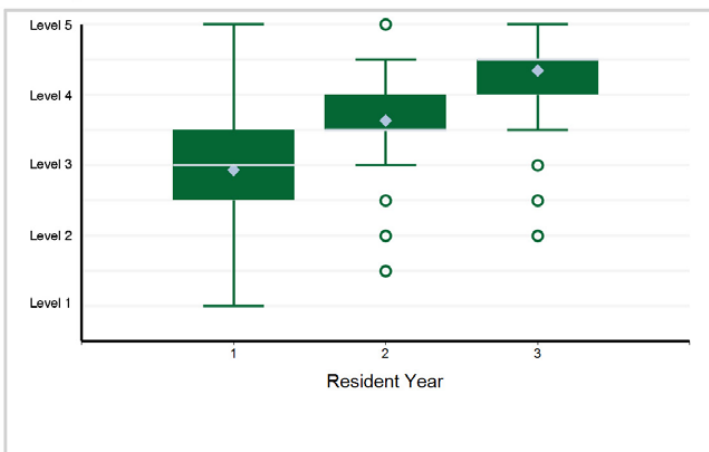

11. Practice-Based Learning and Improvement - Practice-Based Learning and Improvement 2: Reflective Practice and Commitment ...

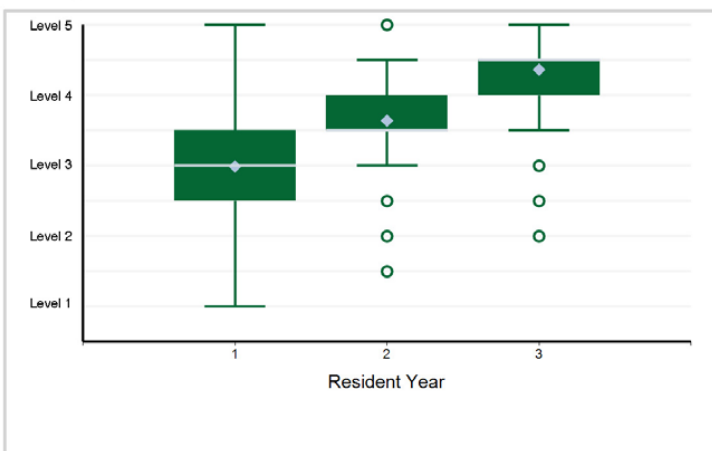

12. Professionalism - Professionalism 1: Professional Behavior and Ethical Principles

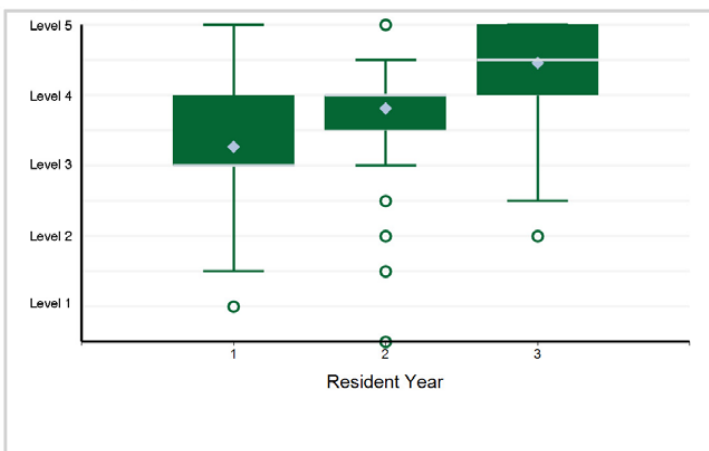

Specialty Box Plot Report - Milestone Evaluation by Resident Year: Year-End 2021-2022

SUBSPECIALTY: Gastroenterology

13. Professionalism - Professionalism 2: Accountability/Conscientiousness

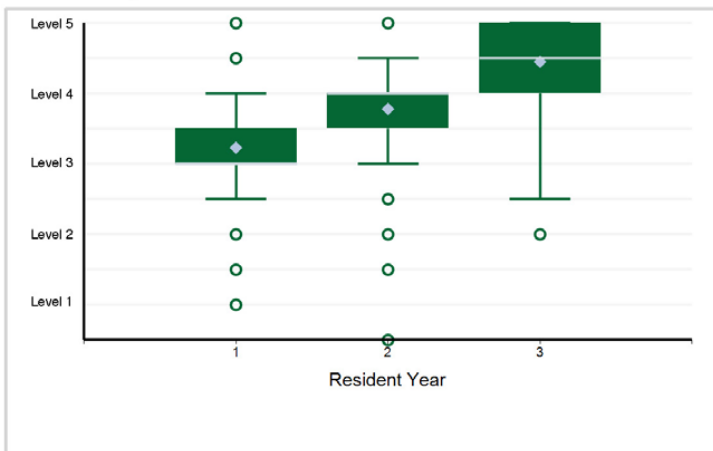

14. Professionalism - Professionalism 3: Self-Awareness and Help-Seeking

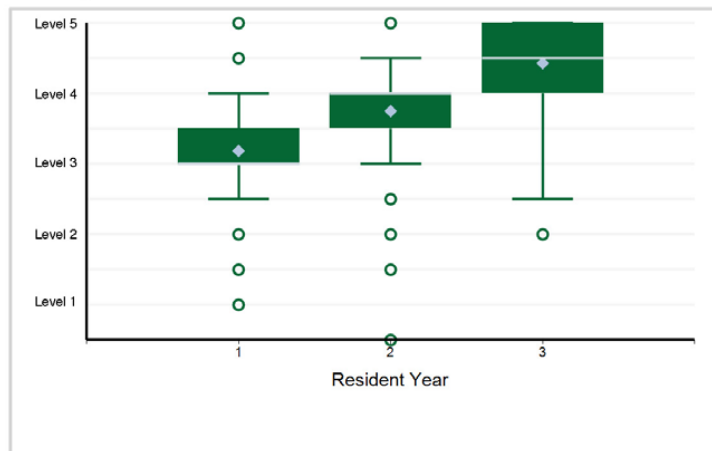

15. Interpersonal and Communication Skills - Interpersonal and Communication Skills 1: Patient- and Family-Centered Communication

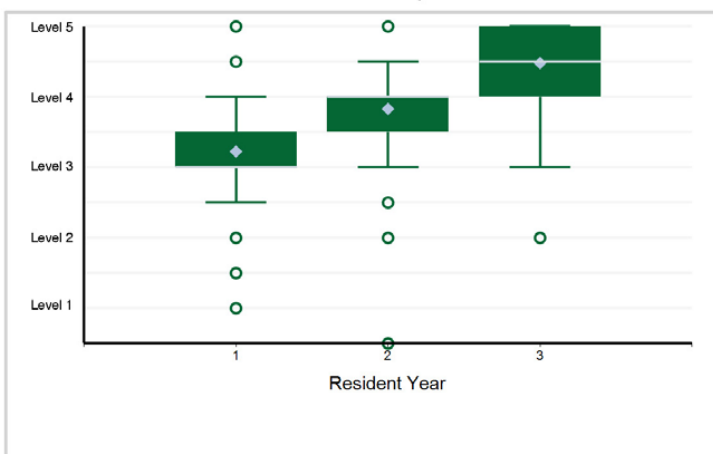

16. Interpersonal and Communication Skills - Interpersonal and Communication Skills 2: Interprofessional and Team Communication

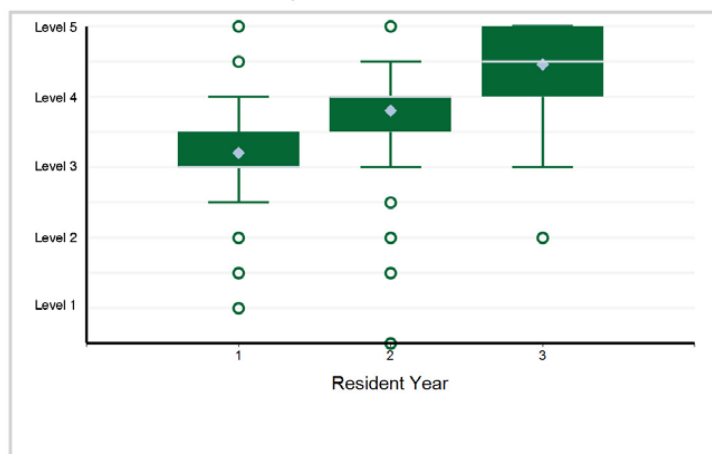

17. Interpersonal and Communication Skills - Interpersonal and Communication Skills 3: Communication within Health Care Systems

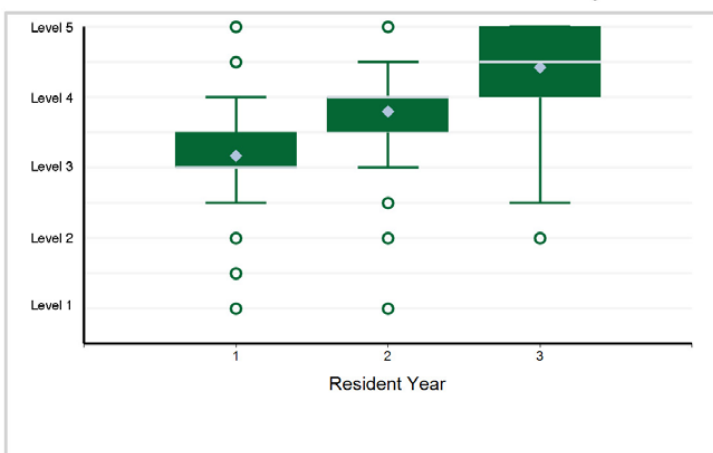

Specialty Box Plot Report - Milestone Evaluation by Resident Year: Year-End 2021-2022

TABLE 37: SUBSPECIALTY: **Gastroenterology - Transplant Hepatology Pathway**

Resident Year	1	2	3	Total Residents*
# of Residents	1	8	11	20

*Note: There is 1 resident with an incomplete milestone evaluation that is excluded from the box plots below.

1. Patient Care - Patient Care 1: Data Gathering and Non-Procedural Diagnostic Testing

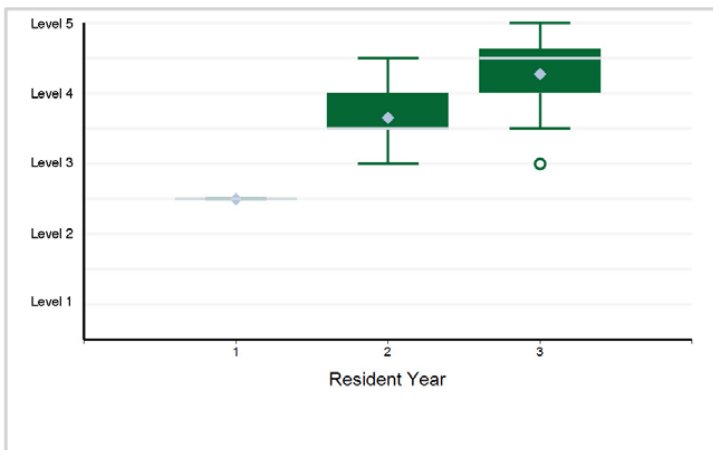

2. Patient Care - Patient Care 2: Patient Management in Gastrointestinal and Liver Disease

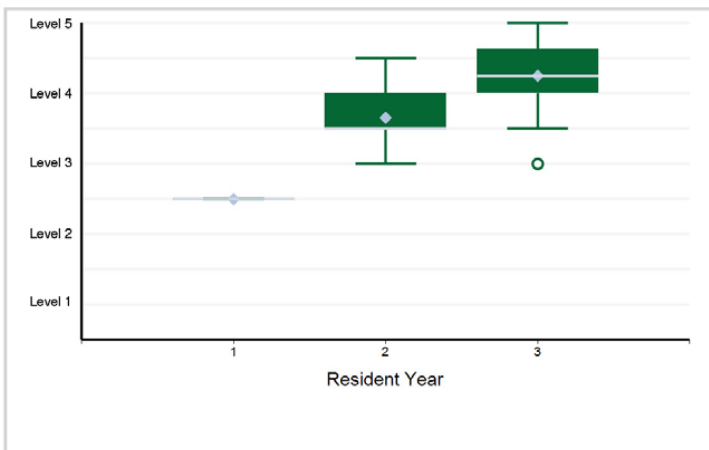

3. Patient Care - Patient Care 3: Procedures Cognitive Components

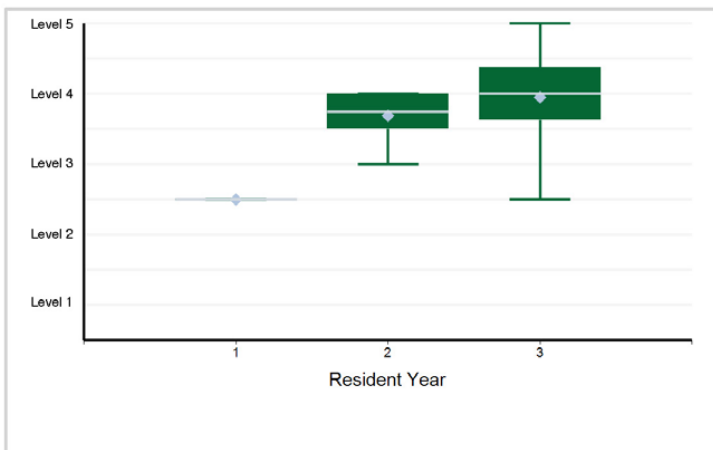

4. Patient Care - Patient Care 4: Procedures: Technical Components

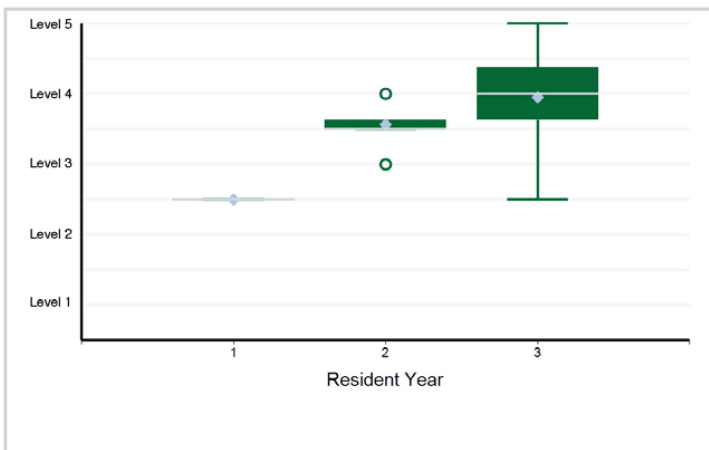

5. Medical Knowledge - Medical Knowledge 1: Clinical Knowledge of Gastrointestinal and Liver Diseases (Non-Procedural)

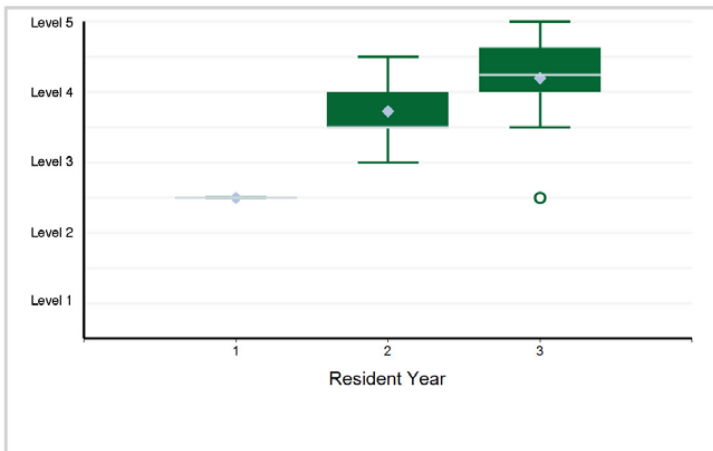

6. Medical Knowledge - Medical Knowledge 2: Clinical Reasoning

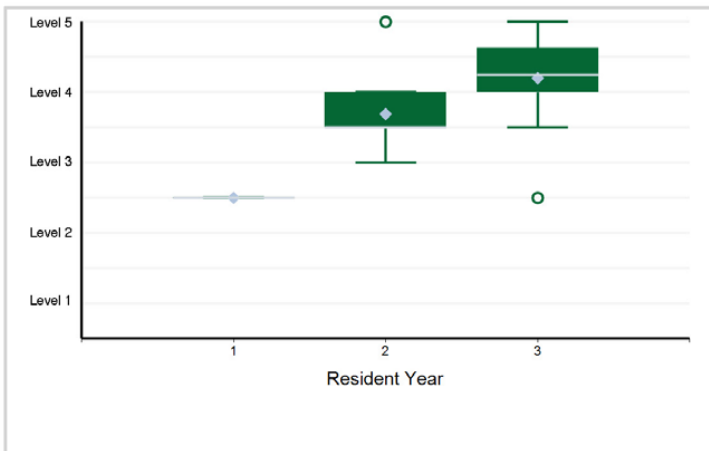

Specialty Box Plot Report - Milestone Evaluation by Resident Year: Year-End 2021-2022

SUBSPECIALTY: Gastroenterology - Transplant Hepatology Pathway

7. Systems-Based Practice - Systems-Based Practice 1: Patient Safety and Quality Improvement

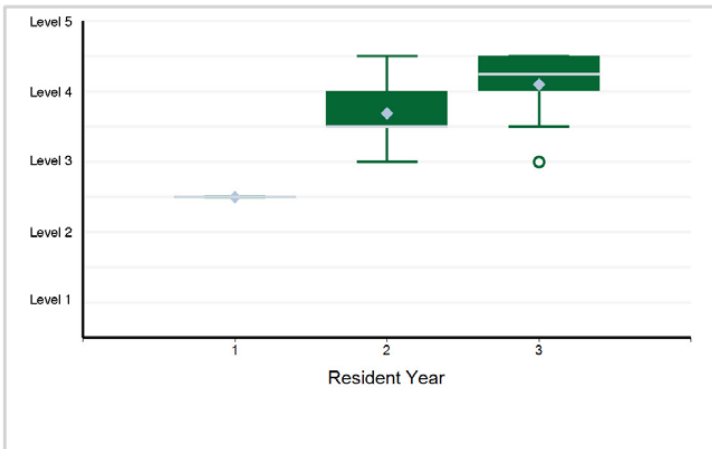

8. Systems-Based Practice - Systems-Based Practice 2: System Navigation for Patient-Centered Care

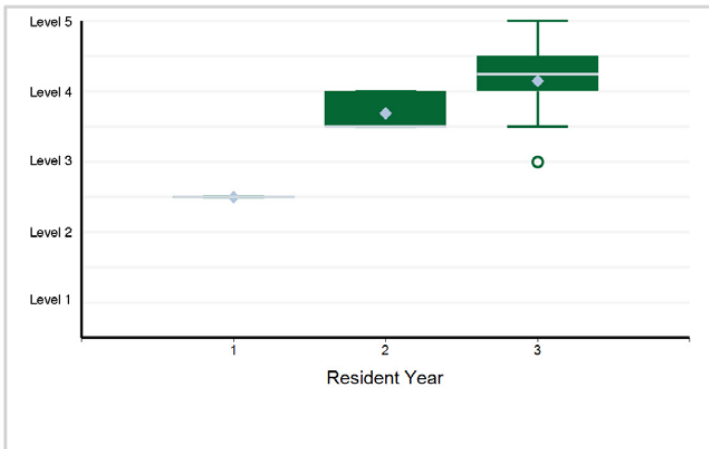

9. Systems-Based Practice - Systems-Based Practice 3: Physician Role in Health Care Systems

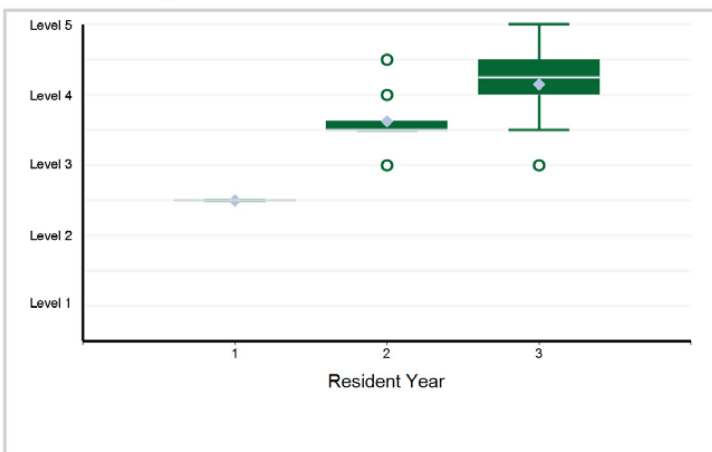

10. Practice-Based Learning and Improvement - Practice-Based Learning and Improvement 1: Evidence-Based and Informed Practice

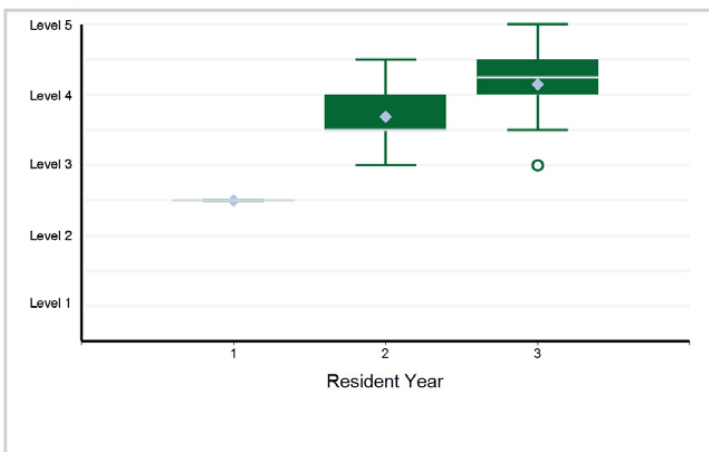

11. Practice-Based Learning and Improvement - Practice-Based Learning and Improvement 2: Reflective Practice and Commitment ...

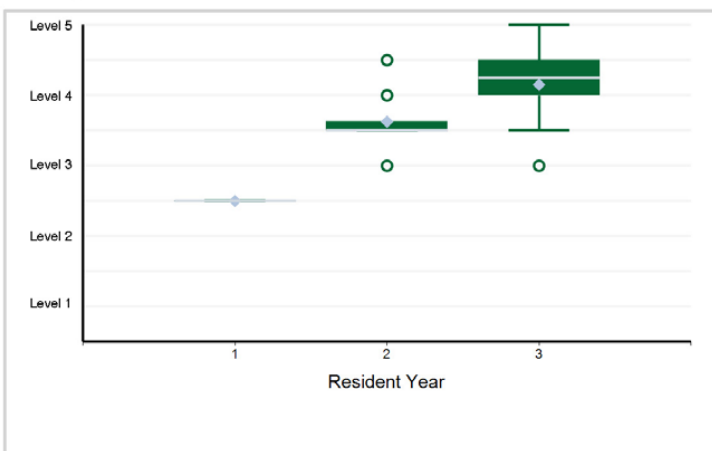

12. Professionalism - Professionalism 1: Professional Behavior and Ethical Principles

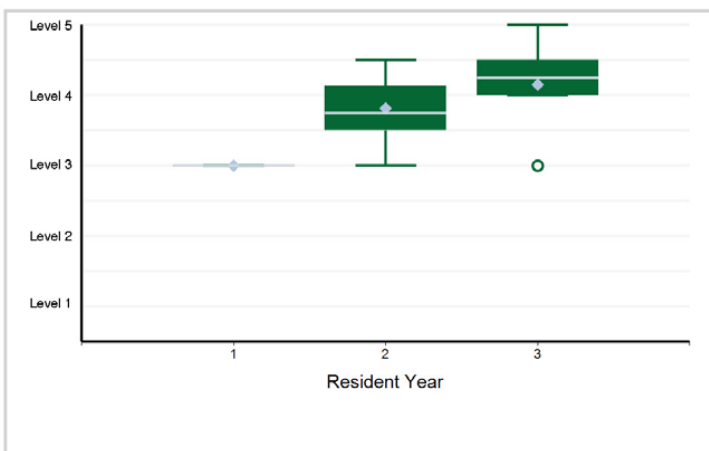

Specialty Box Plot Report - Milestone Evaluation by Resident Year: Year-End 2021-2022

SUBSPECIALTY: Gastroenterology - Transplant Hepatology Pathway

13. Professionalism - Professionalism 2: Accountability/Conscientiousness

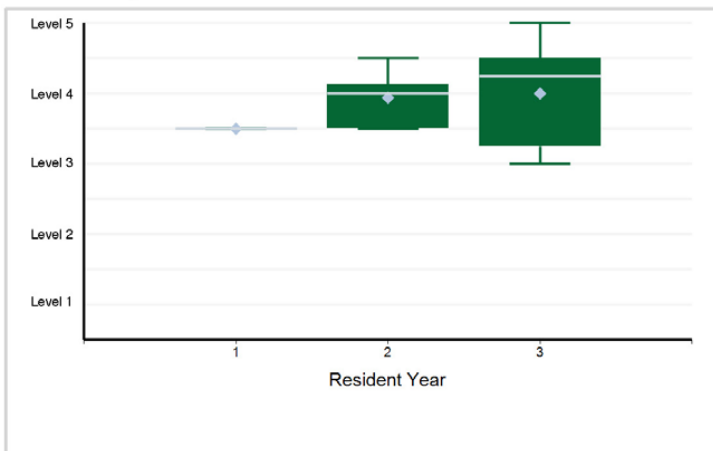

14. Professionalism - Professionalism 3: Self-Awareness and Help-Seeking

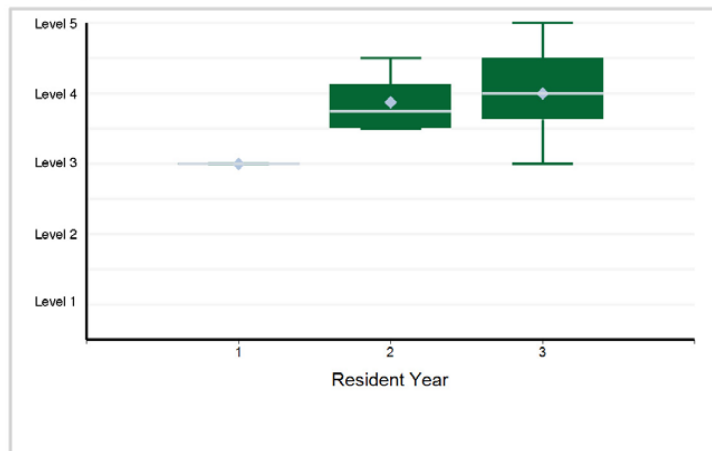

15. Interpersonal and Communication Skills - Interpersonal and Communication Skills 1: Patient- and Family-Centered Communication

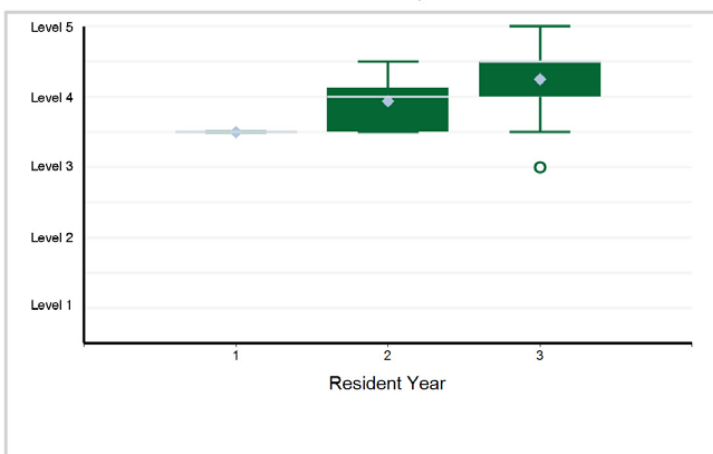

16. Interpersonal and Communication Skills - Interpersonal and Communication Skills 2: Interprofessional and Team Communication

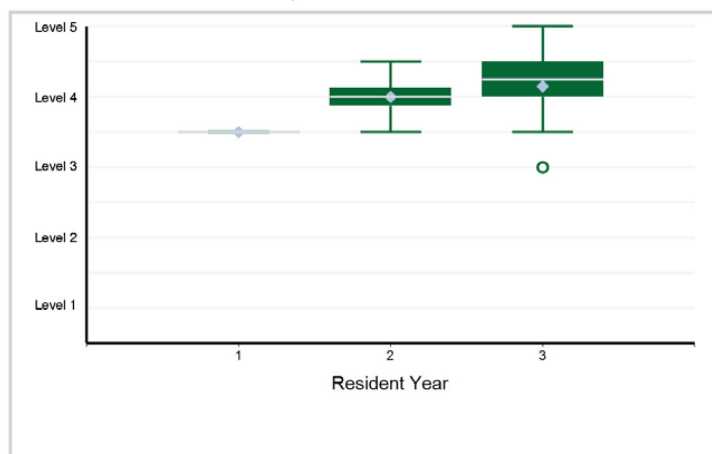

17. Interpersonal and Communication Skills - Interpersonal and Communication Skills 3: Communication within Health Care Systems

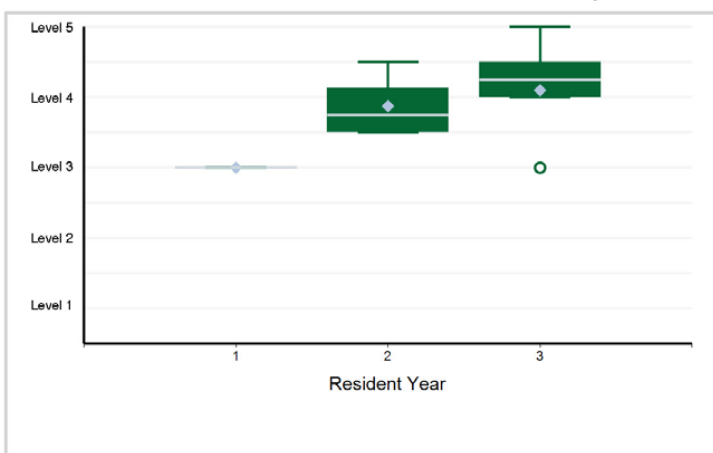

Specialty Box Plot Report - Milestone Evaluation by Resident Year: Year-End 2021-2022

SUBSPECIALTY: Gastroenterology - Transplant Hepatology Pathway

Resident Year	1	2	3	Total Residents*
# of Residents	1	8	11	20

*Note: There is 1 resident with an incomplete milestone evaluation that is excluded from the box plots below.

This specialty has residents participating in the Dual GI/TH Pathway track, which required a response to the following Transplant Hepatology specific Milestones.

1. Patient Care - Patient Care 1: Data Gathering and Non-Procedural Diagnostic Testing

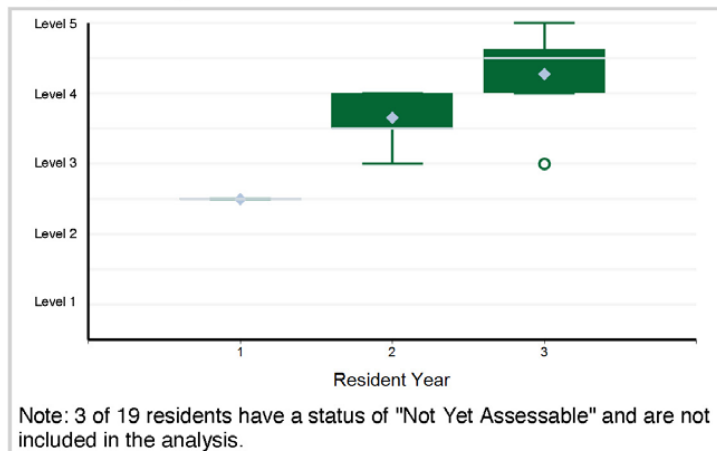

2. Patient Care - Patient Care 2: Patient Management in Gastrointestinal and Liver Disease

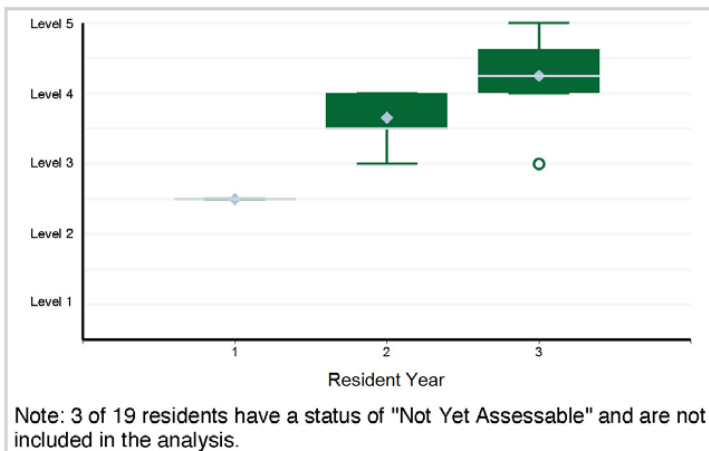

3. Patient Care - Patient Care 3: Technical Procedures – Liver Biopsy

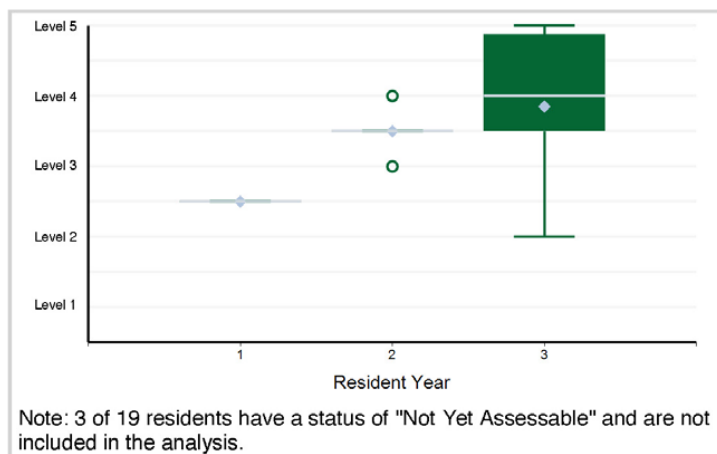

4. Medical Knowledge - Medical Knowledge 1: Clinical Knowledge of Gastrointestinal and Liver Diseases (Non-Procedural)

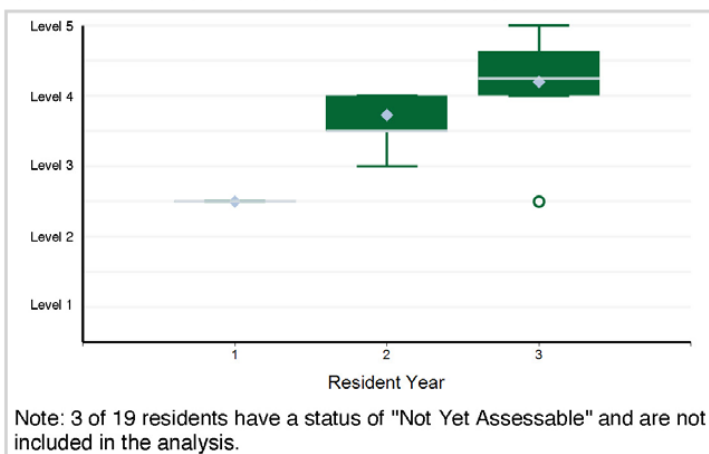

5. Medical Knowledge - Medical Knowledge 2: Clinical Reasoning

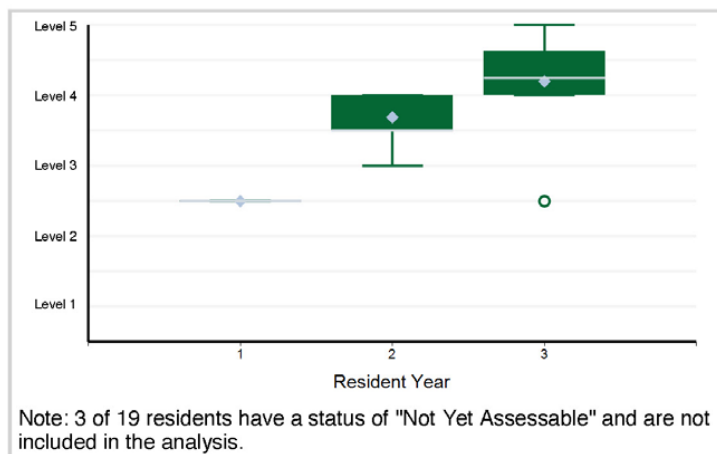

Specialty Box Plot Report - Milestone Evaluation by Resident Year: Year-End 2021-2022

TABLE 38: SUBSPECIALTY: **Geriatric Medicine (multidisciplinary, Internal Medicine)**

Resident Year	1	Total Residents
# of Residents	298	298

1. Patient Care - Patient Care 1: Comprehensive Geriatric Assessment

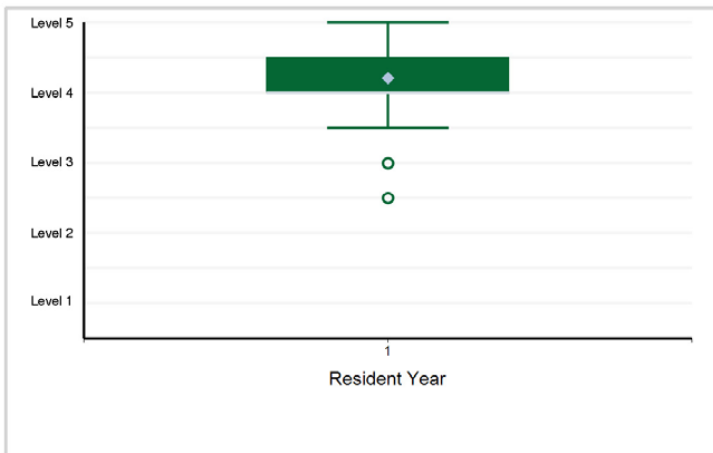

2. Patient Care - Patient Care 2: Patient and Family/Caregiver Support

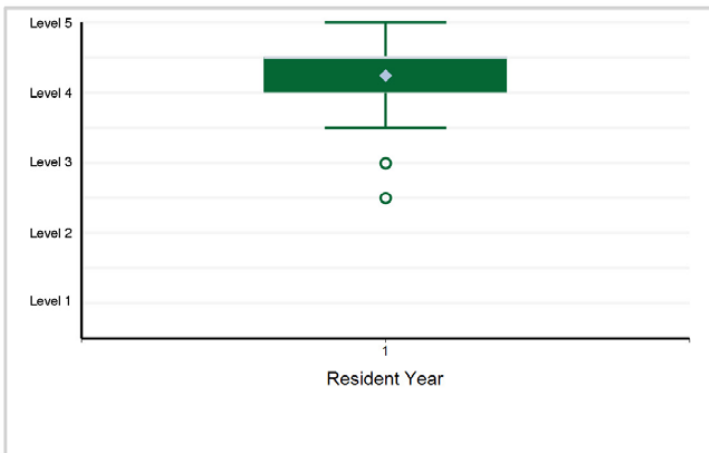

3. Patient Care - Patient Care 3: Assessing and Optimizing of Pharmacotherapy

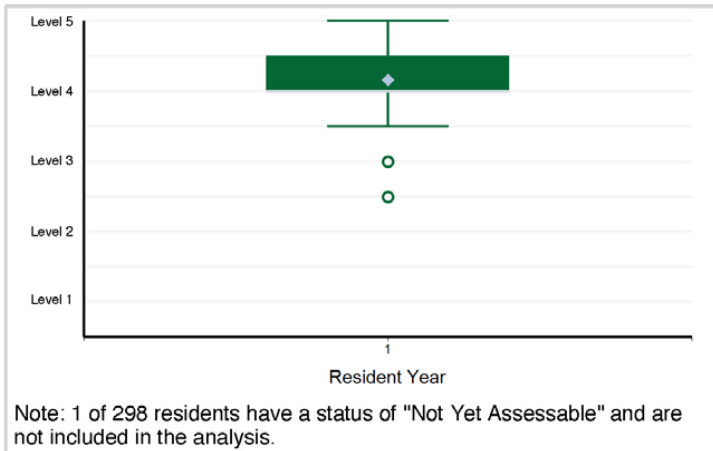

4. Patient Care - Patient Care 4: Assessing and Optimizing Physical and Cognitive Function

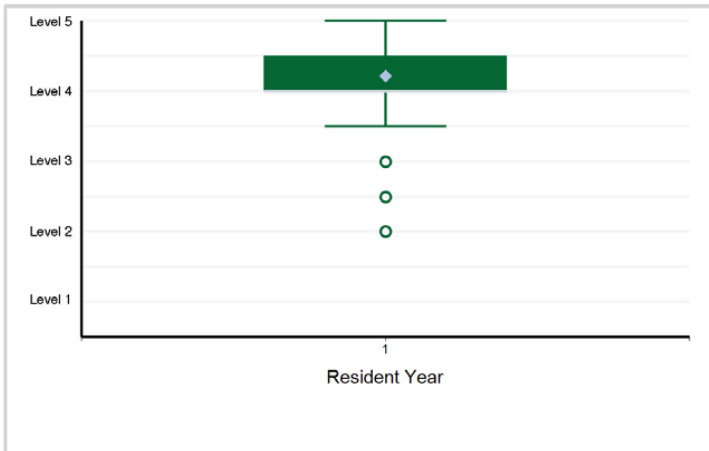

5. Patient Care - Patient Care 5: Framing Clinical Management Decisions within the Context of Prognosis

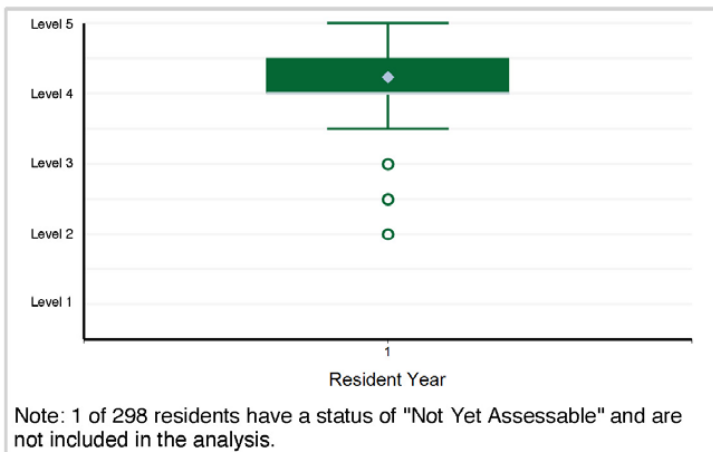

6. Patient Care - Patient Care 6: Consultative Care

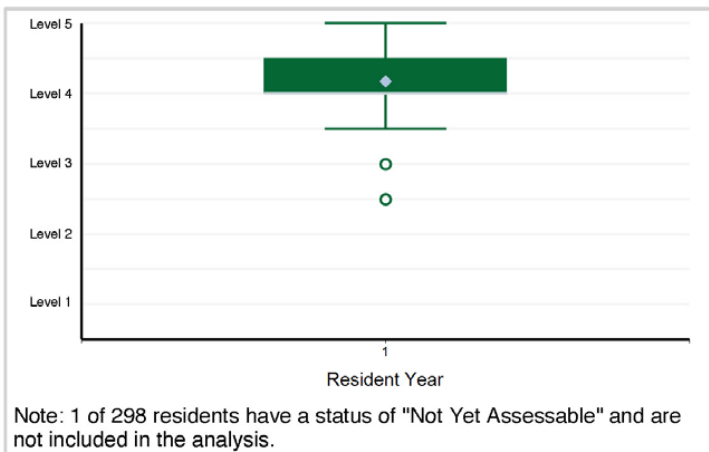

Specialty Box Plot Report - Milestone Evaluation by Resident Year: Year-End 2021-2022

SUBSPECIALTY: **Geriatric Medicine (multidisciplinary, Internal Medicine)**

7. Medical Knowledge - Medical Knowledge 1: Geriatric Syndromes

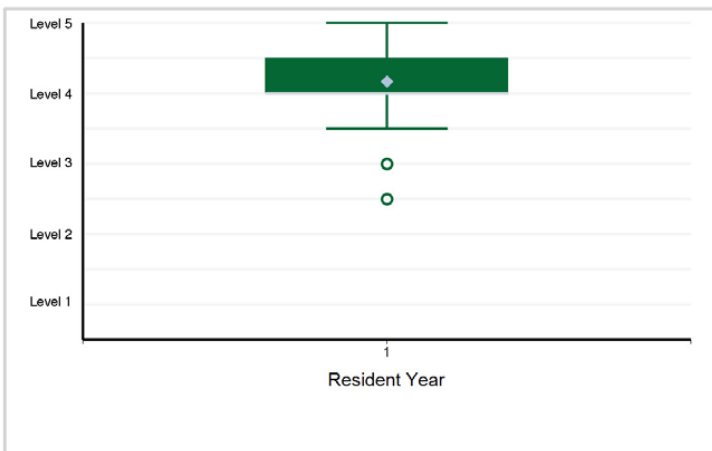

8. Medical Knowledge - Medical Knowledge 2: Principles of Aging

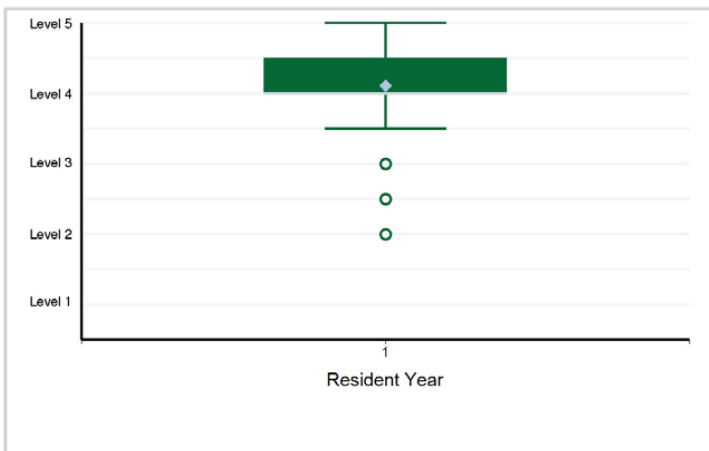

9. Systems-Based Practice - Systems-Based Practice 1: Patient Safety and Quality Improvement

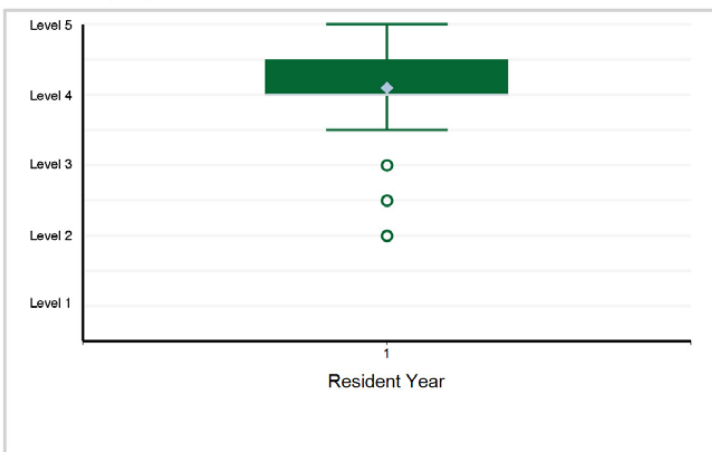

10. Systems-Based Practice - Systems-Based Practice 2: System Navigation for Patient-Centered Care

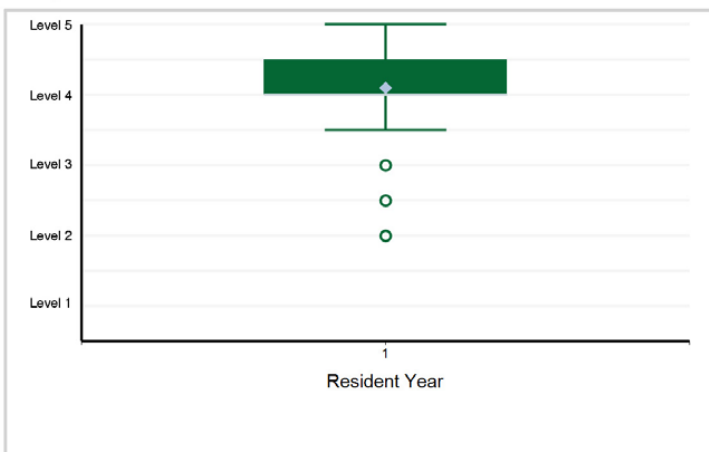

11. Systems-Based Practice - Systems-Based Practice 3: Physician Role in Health Care Systems

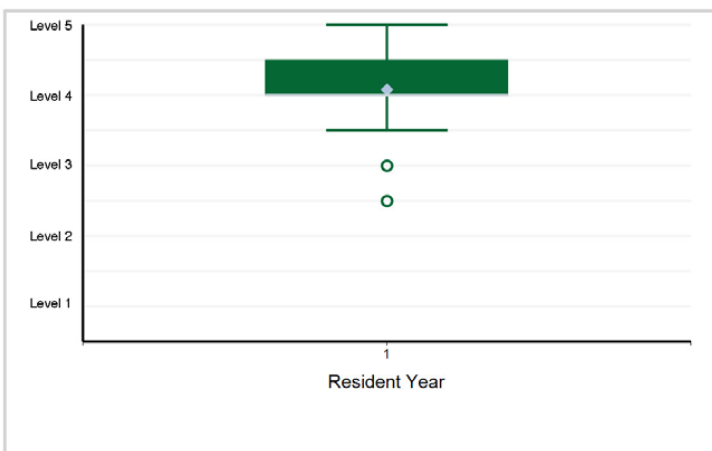

12. Systems-Based Practice - Systems-Based Practice 4: Models and Systems of Care

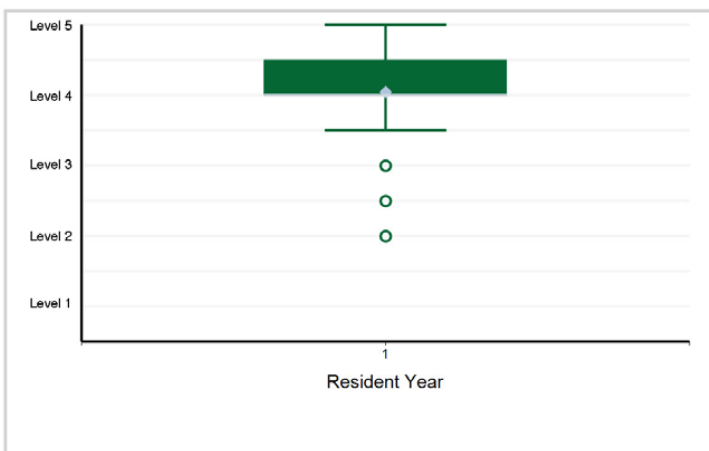

Specialty Box Plot Report - Milestone Evaluation by Resident Year: Year-End 2021-2022

SUBSPECIALTY: Geriatric Medicine (multidisciplinary, Internal Medicine)

13. Practice-Based Learning and Improvement - Practice-Based Learning and Improvement 1: Evidence-Based and Informed Practice



14. Practice-Based Learning and Improvement - Practice-Based Learning and Improvement 2: Reflective Practice and Commitment ...

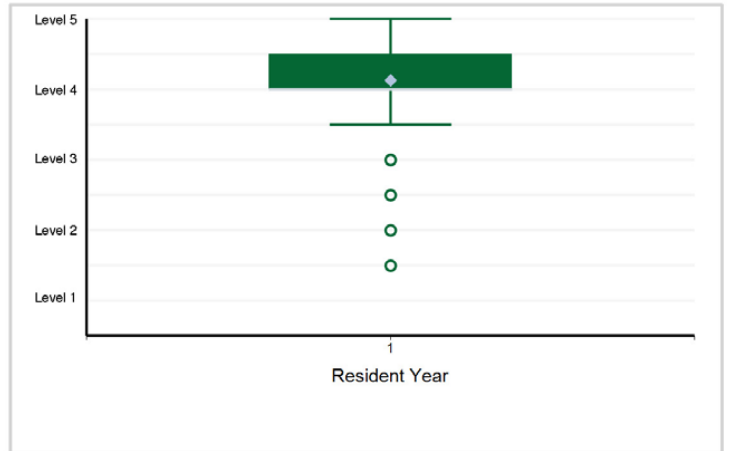

15. Professionalism - Professionalism 1: Professional Behavior

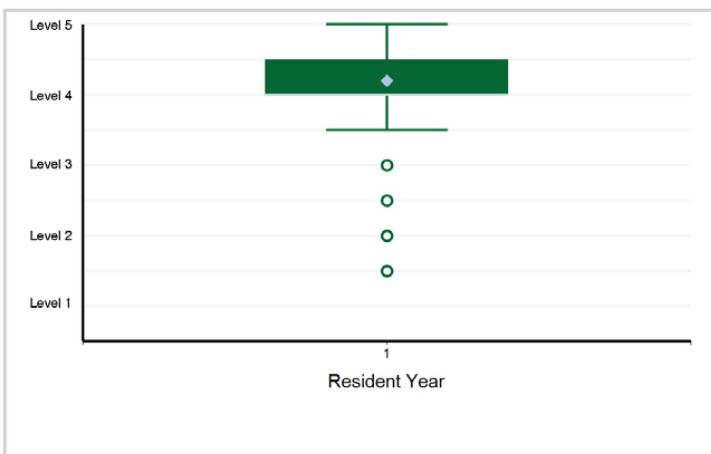

16. Professionalism - Professionalism 2: Ethical Principles

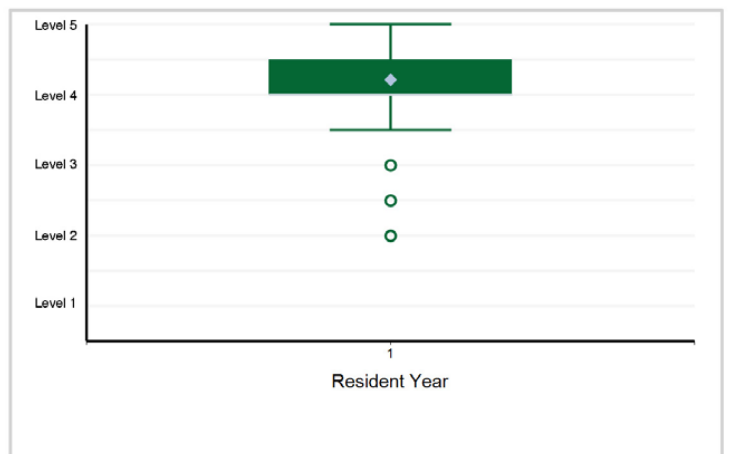

17. Professionalism - Professionalism 3: Accountability/Conscientiousness



18. Professionalism - Professionalism 4: Well-Being

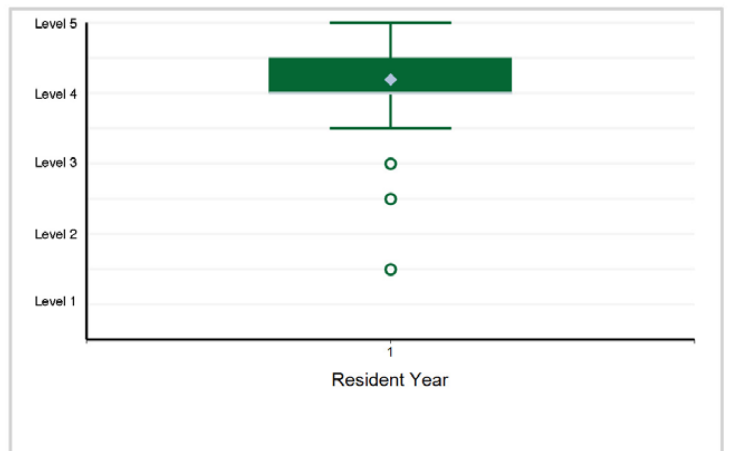

Specialty Box Plot Report - Milestone Evaluation by Resident Year: Year-End 2021-2022

SUBSPECIALTY: **Geriatric Medicine (multidisciplinary, Internal Medicine)**

19. Interpersonal and Communication Skills - Interpersonal and Communication Skills 1: Patient- and Family-Centered Communication



20. Interpersonal and Communication Skills - Interpersonal and Communication Skills 2: Interprofessional and Team Communication

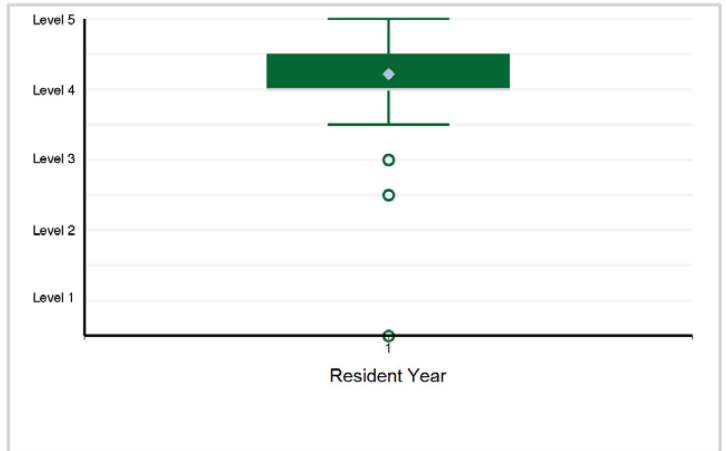

21. Interpersonal and Communication Skills - Interpersonal and Communication Skills 3: Communication within Health Care Systems

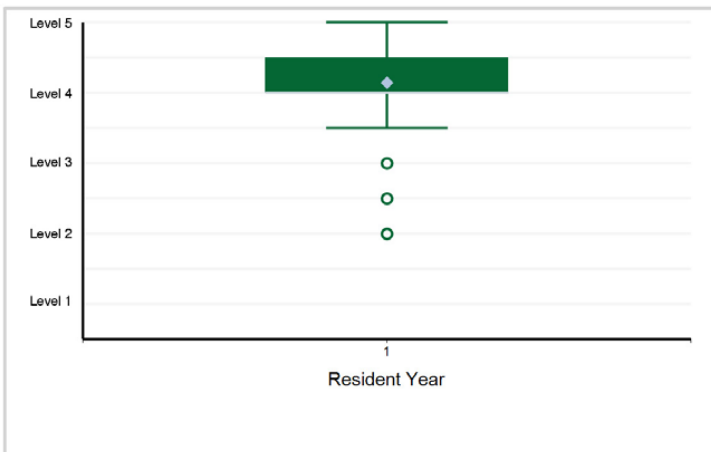

22. Interpersonal and Communication Skills - Interpersonal and Communication Skills 4: Complex Communication around Serious ...

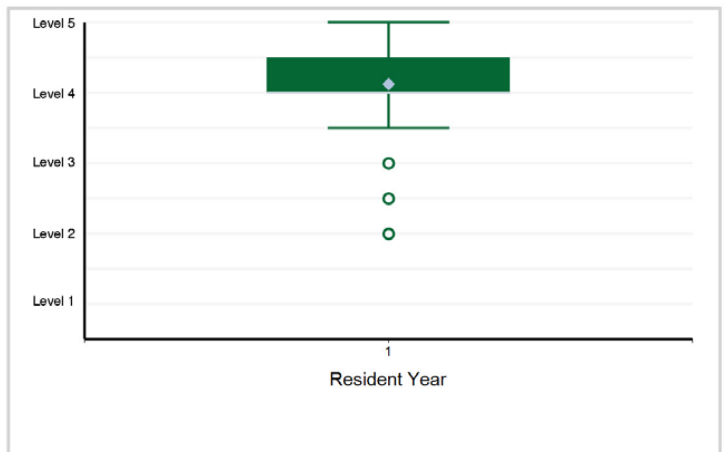

Specialty Box Plot Report - Milestone Evaluation by Resident Year: Year-End 2021-2022

TABLE 39: SUBSPECIALTY: Hematology and Medical Oncology

Resident Year	1	2	3	Total Residents
# of Residents	689	681	606	1,976

1. Patient Care - Patient Care 1: Accesses Data Sources to Synthesize Patient and Disease Specific Information ...

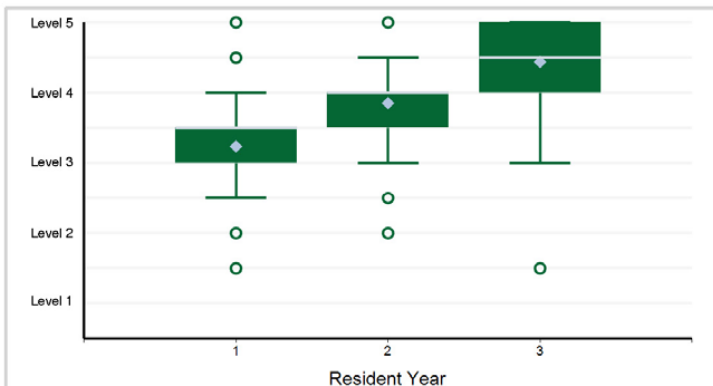

Note: 2 of 1,976 residents have a status of "Not Yet Assessable" and are not included in the analysis.

2. Patient Care - Patient Care 2: Diagnoses and Assigns Stage and Severity of Hematology and Oncology Disorders

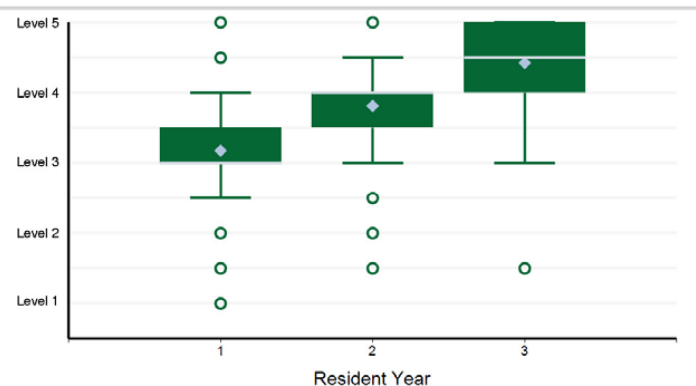

Note: 2 of 1,976 residents have a status of "Not Yet Assessable" and are not included in the analysis.

3. Patient Care - Patient Care 3: Formulates the Management Plan

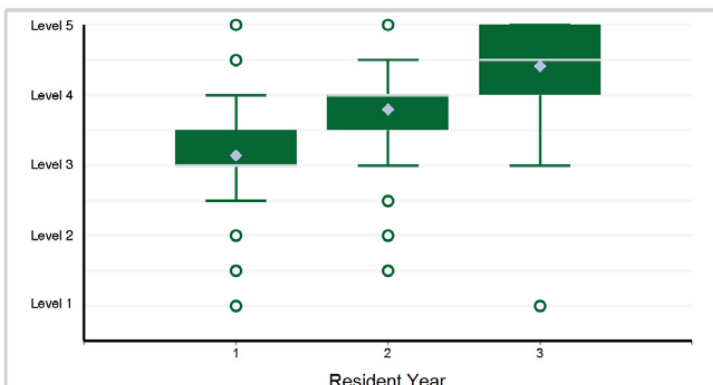

Note: 1 of 1,976 residents have a status of "Not Yet Assessable" and are not included in the analysis.

4. Patient Care - Patient Care 4: Adjusts Management Plans for Acute and Chronic Issues

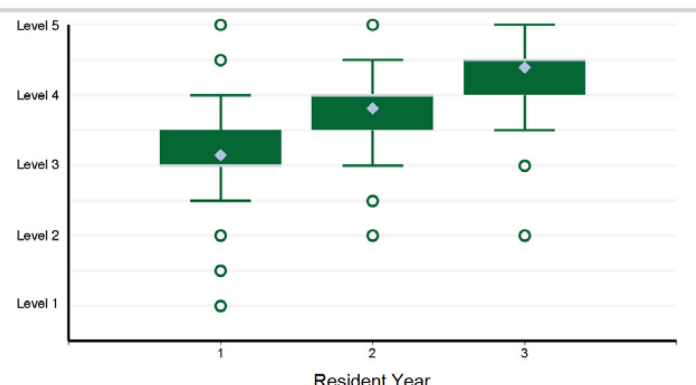

Note: 2 of 1,976 residents have a status of "Not Yet Assessable" and are not included in the analysis.

5. Patient Care - Patient Care 5: Competence in Procedures: • Performance of Bone Marrow Biopsies and Aspirations ...

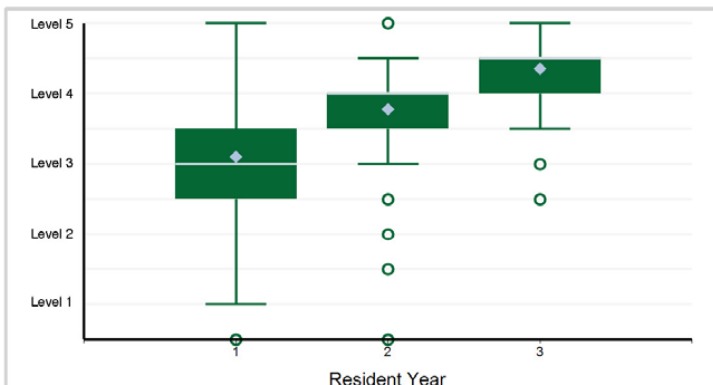

Note: 12 of 1,976 residents have a status of "Not Yet Assessable" and are not included in the analysis.

6. Medical Knowledge - Medical Knowledge 1: Non-Malignant Hematology (includes Pathophysiology, Diagnostics, ...

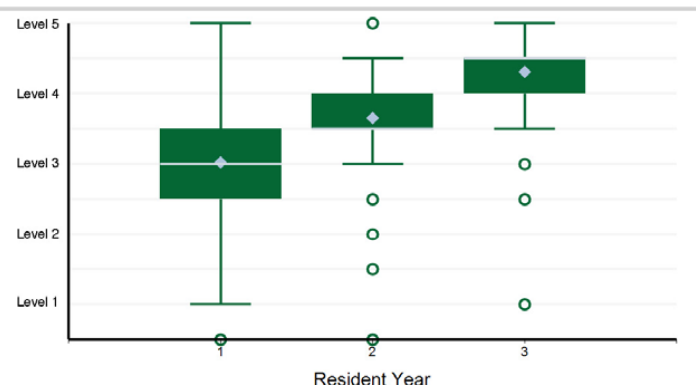

Note: 23 of 1,976 residents have a status of "Not Yet Assessable" and are not included in the analysis.

Specialty Box Plot Report - Milestone Evaluation by Resident Year: Year-End 2021-2022

SUBSPECIALTY: Hematology and Medical Oncology

7. Medical Knowledge - Medical Knowledge 2: Malignant Hematology (includes Pathophysiology, Diagnostics, ...)

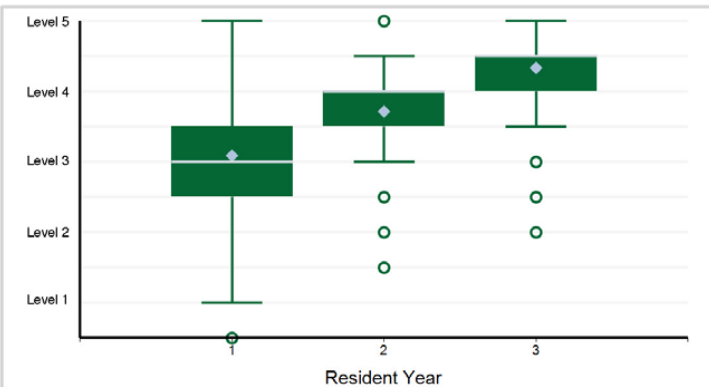

Note: 3 of 1,976 residents have a status of "Not Yet Assessable" and are not included in the analysis.

8. Medical Knowledge - Medical Knowledge 3: Solid Tumor Oncology (includes Pathophysiology, Diagnostics, ...)

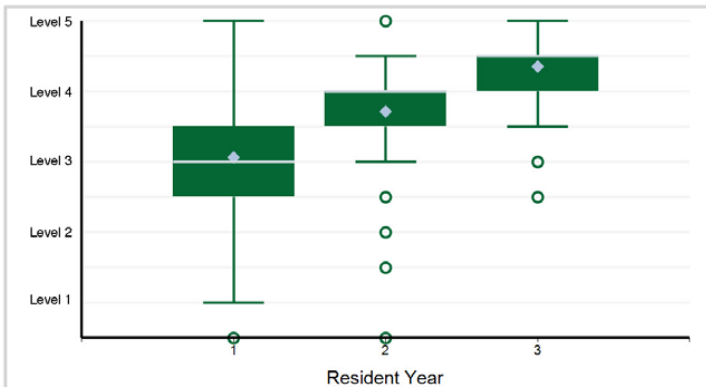

Note: 10 of 1,976 residents have a status of "Not Yet Assessable" and are not included in the analysis.

9. Medical Knowledge - Medical Knowledge 4: Scholarly Activity

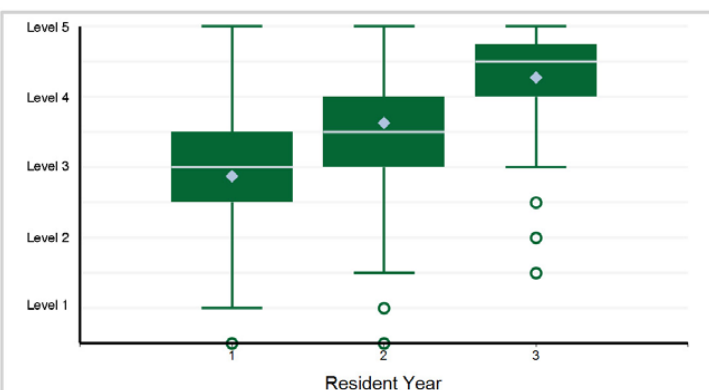

Note: 62 of 1,976 residents have a status of "Not Yet Assessable" and are not included in the analysis.

10. Systems-Based Practice - Systems-Based Practice 1: Patient Safety

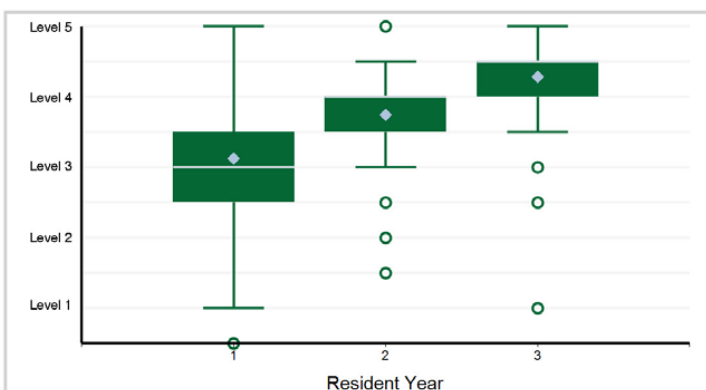

11. Systems-Based Practice - Systems-Based Practice 2: Quality Improvement

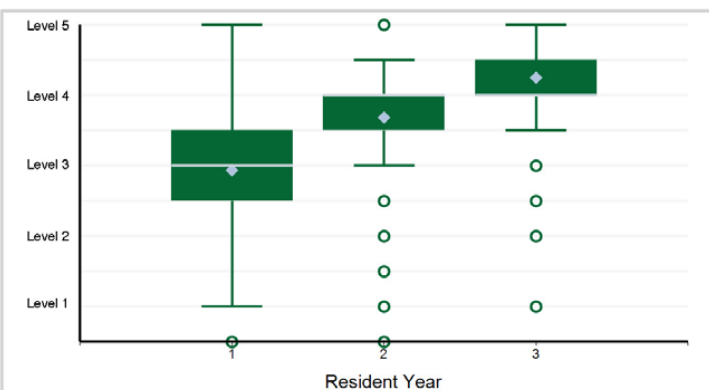

12. Systems-Based Practice - Systems-Based Practice 3: System Navigation for Patient-Centered Care: Coordination ...

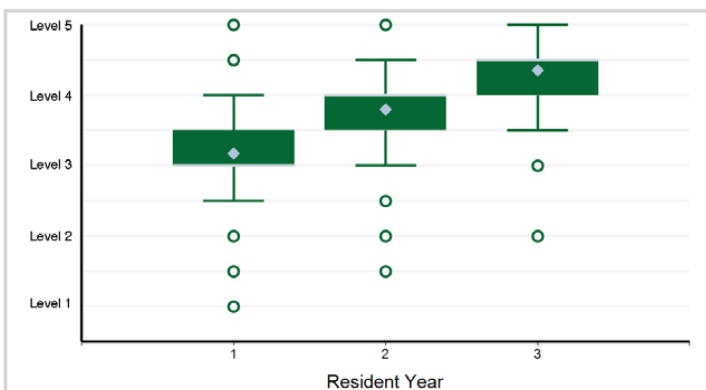

Specialty Box Plot Report - Milestone Evaluation by Resident Year: Year-End 2021-2022

SUBSPECIALTY: Hematology and Medical Oncology

13. Systems-Based Practice - Systems-Based Practice 4: System Navigation for Patient-Centered Care: Population Health

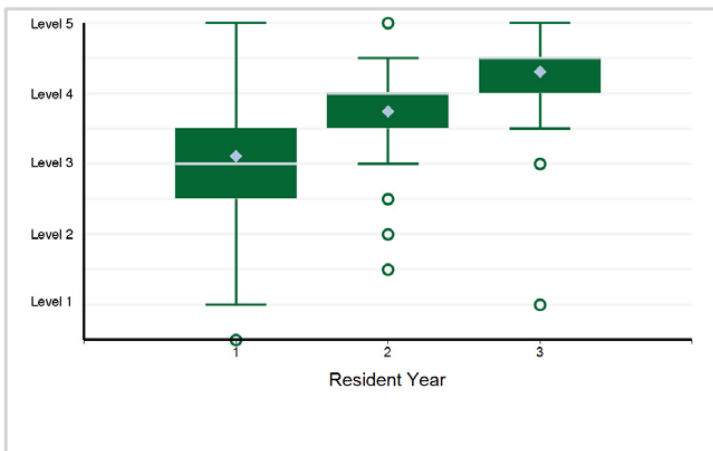

14. Systems-Based Practice - Systems-Based Practice 5: Physician Role in Health Care Systems

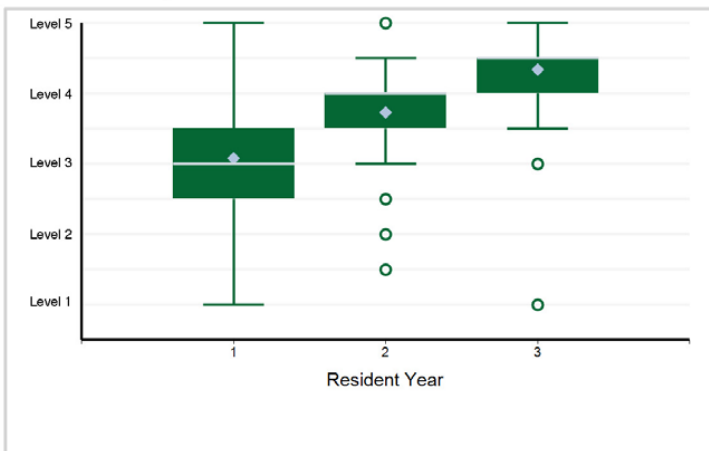

15. Practice-Based Learning and Improvement - Practice-Based Learning and Improvement 1: Evidence-Based and Informed Practice

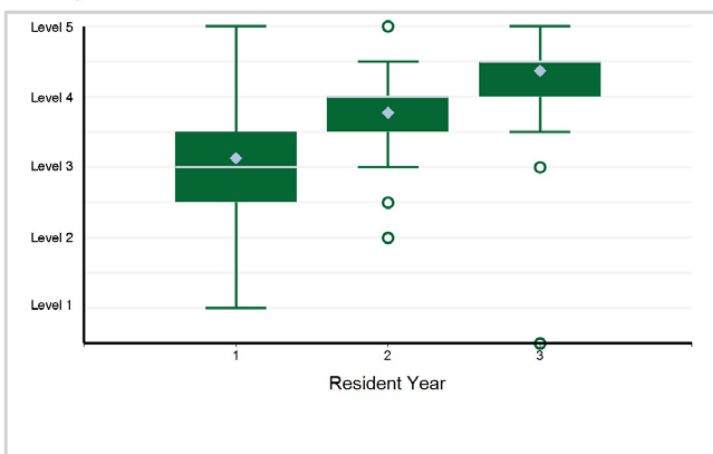

16. Practice-Based Learning and Improvement - Practice-Based Learning and Improvement 2: Reflective Practice and Commitment ...

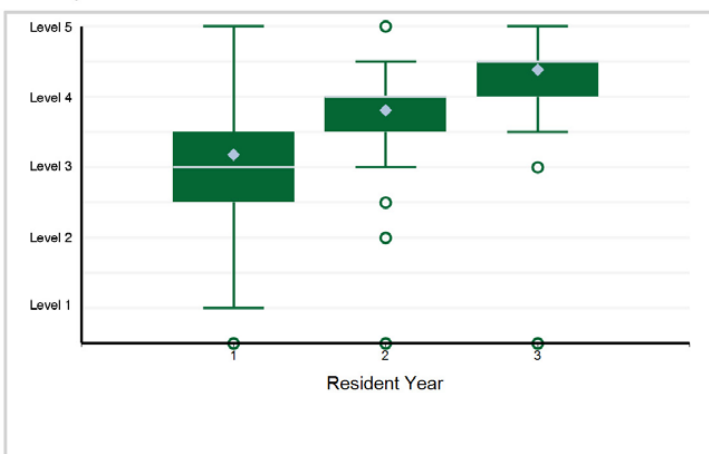

17. Professionalism - Professionalism 1: Professional Behavior and Ethical Principles

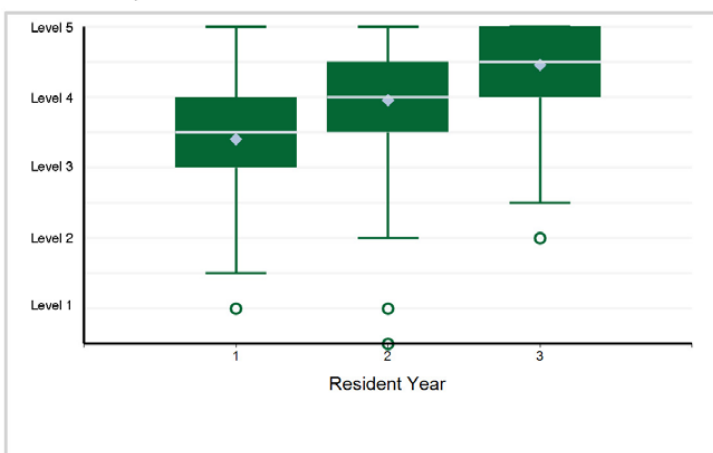

18. Professionalism - Professionalism 2: Accountability/Conscientiousness

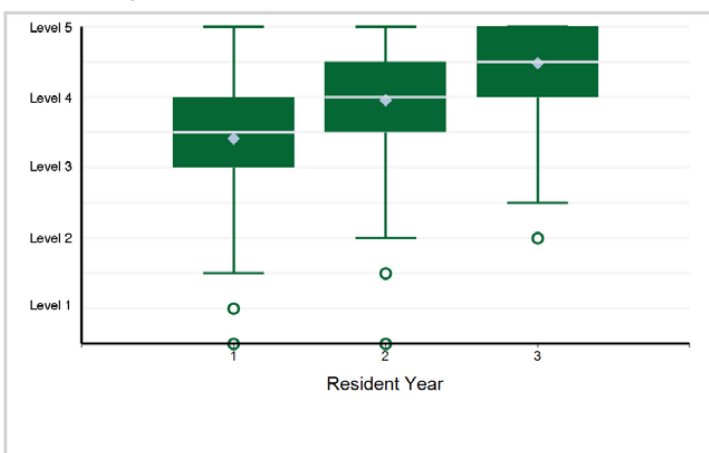

Specialty Box Plot Report - Milestone Evaluation by Resident Year: Year-End 2021-2022

SUBSPECIALTY: Hematology and Medical Oncology

19. Professionalism - Professionalism 3: Fellow Well-Being

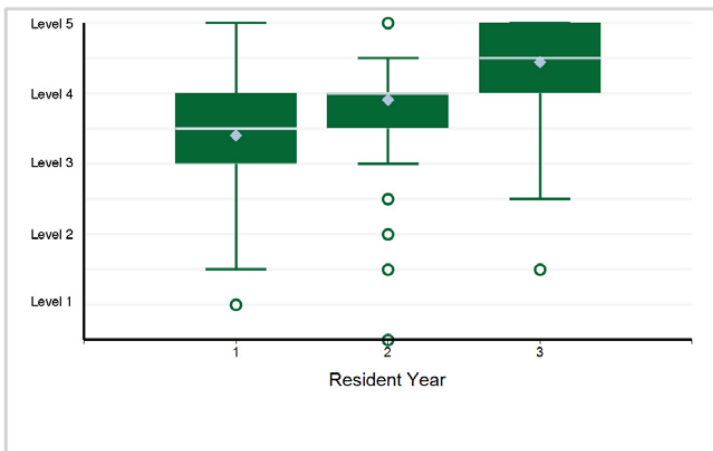

20. Interpersonal and Communication Skills - Interpersonal and Communication Skills 1: Patient- and Family-Centered Communication

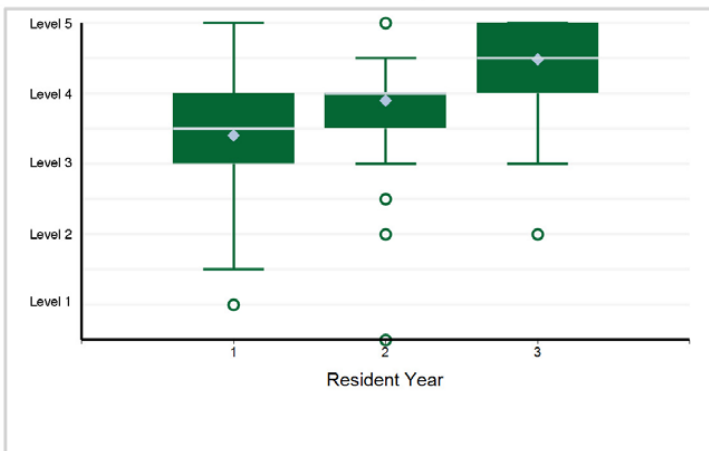

21. Interpersonal and Communication Skills - Interpersonal and Communication Skills 2: Interprofessional and Team Communication

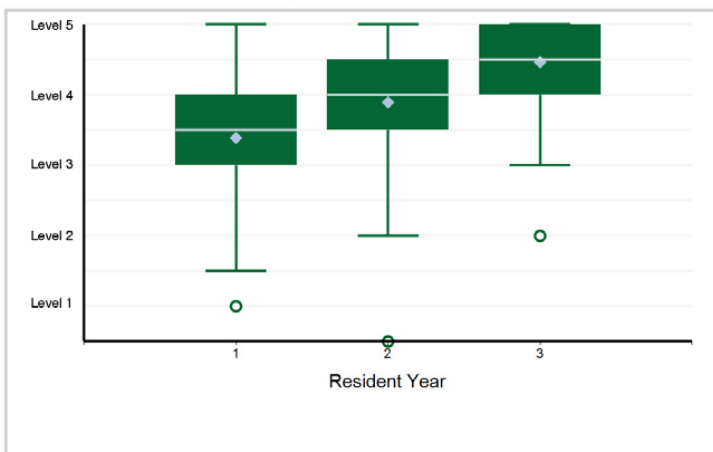

22. Interpersonal and Communication Skills - Interpersonal and Communication Skills 3: Communication within Health Care Systems

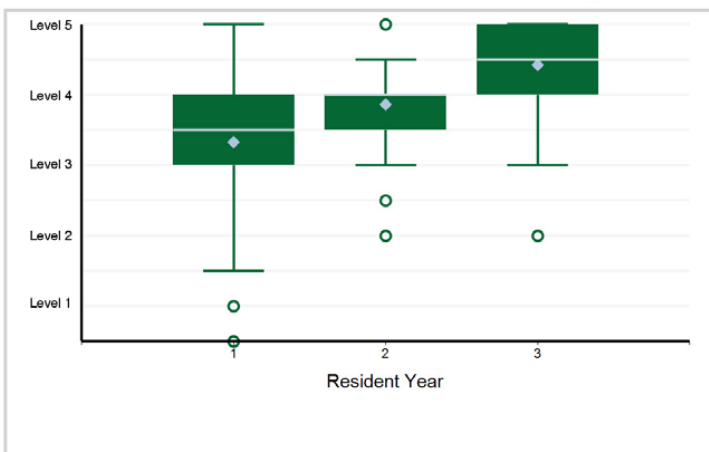

Specialty Box Plot Report - Milestone Evaluation by Resident Year: Year-End 2021-2022

TABLE 40: SUBSPECIALTY: **Infectious Disease**

Resident Year	1	2	Total Residents
# of Residents	427	376	803

1. Patient Care - Patient Care 1: History and Physical Examination

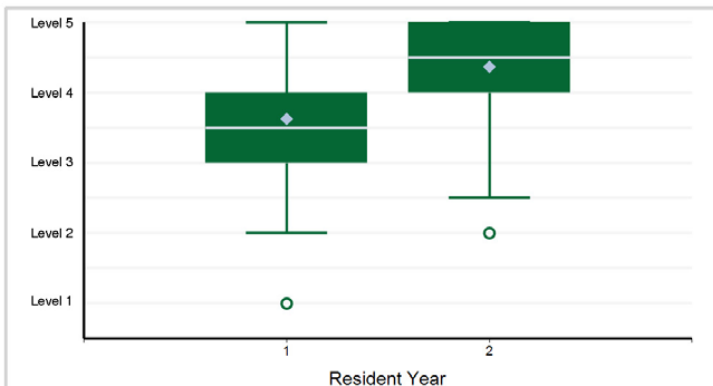

Note: 1 of 803 residents have a status of "Not Yet Assessable" and are not included in the analysis.

2. Patient Care - Patient Care 2: Management of Patients with Possible and Proven Infectious Diseases

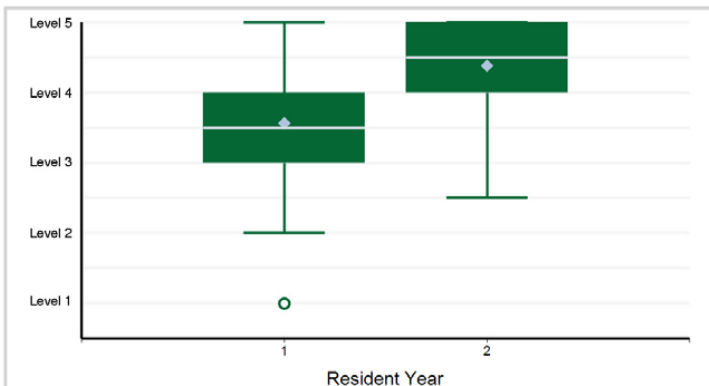

3. Patient Care - Patient Care 3: Consultative Care

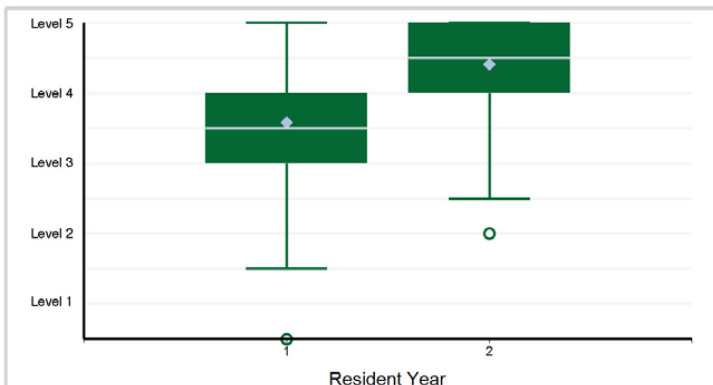

4. Medical Knowledge - Medical Knowledge 1: Diagnostic Reasoning

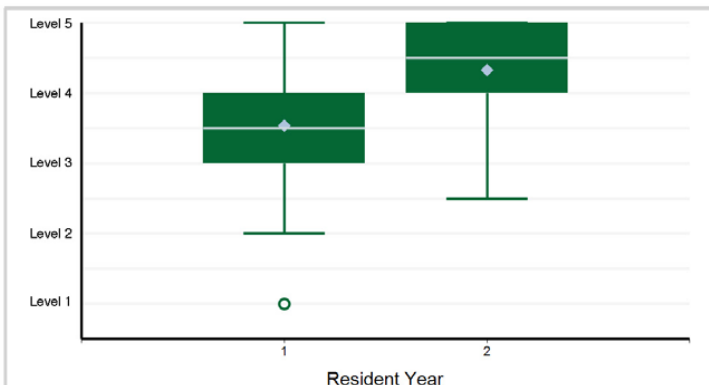

5. Medical Knowledge - Medical Knowledge 2: Diagnostic Evaluation

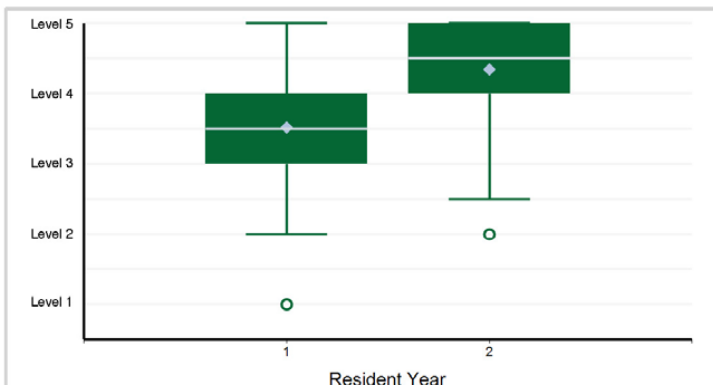

Note: 1 of 803 residents have a status of "Not Yet Assessable" and are not included in the analysis.

6. Medical Knowledge - Medical Knowledge 3: Treatment and Therapeutics including Anti-Infectives, Immunoprophylaxis, ...

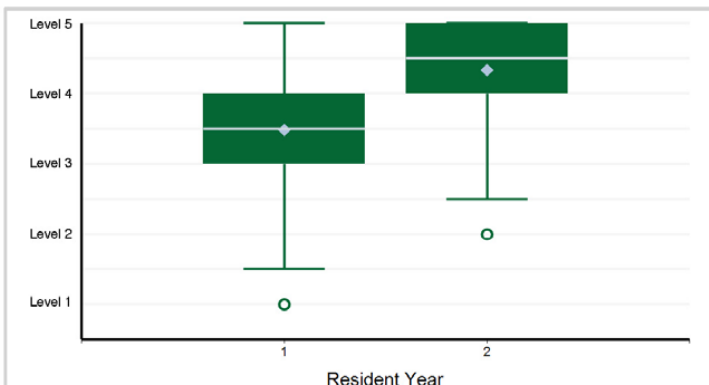

Note: 12 of 803 residents have a status of "Not Yet Assessable" and are not included in the analysis.

Specialty Box Plot Report - Milestone Evaluation by Resident Year: Year-End 2021-2022

SUBSPECIALTY: Infectious Disease

7. Medical Knowledge - Medical Knowledge 4: Infection Control/Prevention, Antimicrobial Stewardship, and Epidemiology

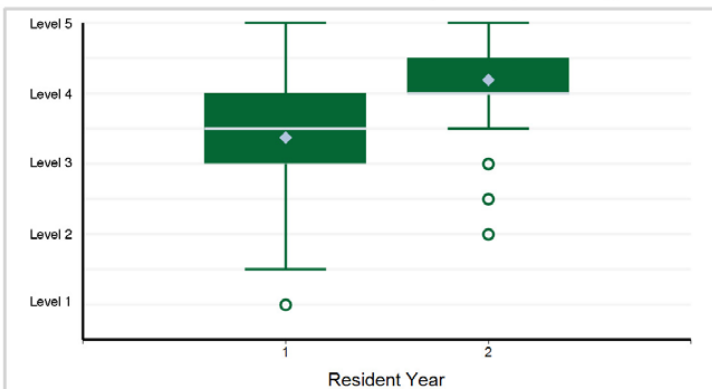

Note: 11 of 803 residents have a status of "Not Yet Assessable" and are not included in the analysis.

8. Medical Knowledge - Medical Knowledge 5: Pathophysiology and Foundational Science

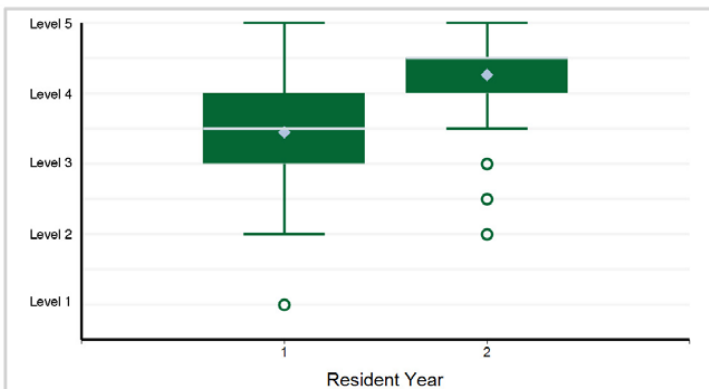

Note: 13 of 803 residents have a status of "Not Yet Assessable" and are not included in the analysis.

9. Medical Knowledge - Medical Knowledge 6: Scholarly Activity

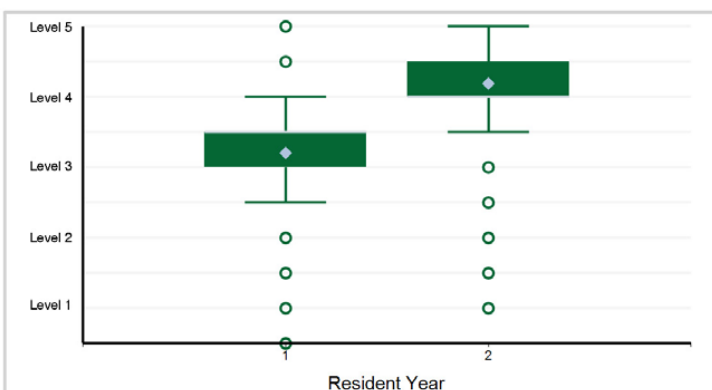

Note: 21 of 803 residents have a status of "Not Yet Assessable" and are not included in the analysis.

10. Systems-Based Practice - Systems-Based Practice 1: Patient Safety

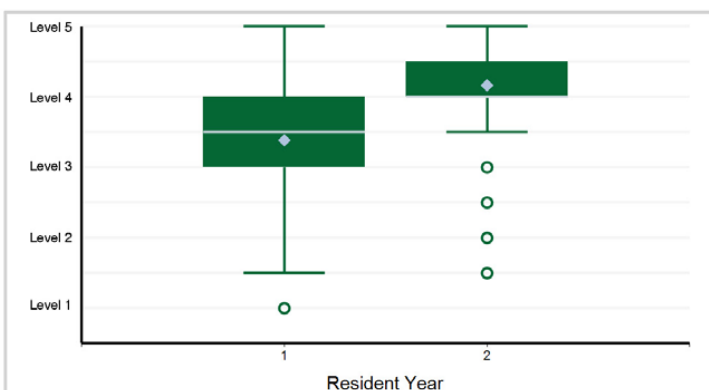

11. Systems-Based Practice - Systems-Based Practice 2: Quality Improvement

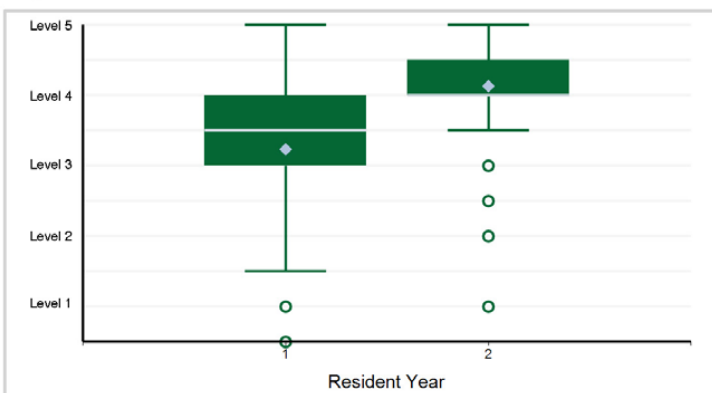

12. Systems-Based Practice - Systems-Based Practice 3: Coordination and Transitions of Care

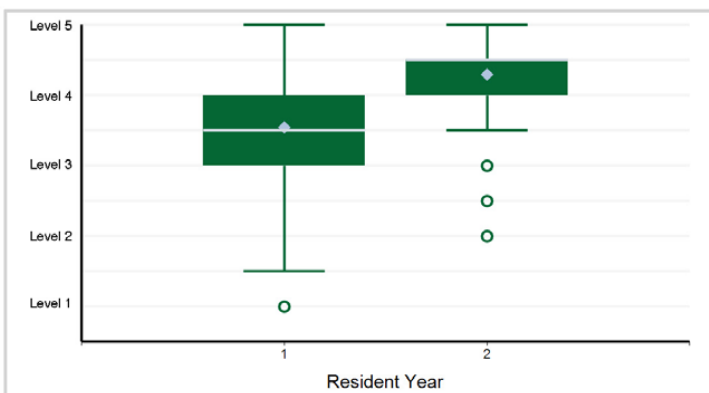

Specialty Box Plot Report - Milestone Evaluation by Resident Year: Year-End 2021-2022

SUBSPECIALTY: Infectious Disease

13. Systems-Based Practice - Systems-Based Practice 4: Population Health

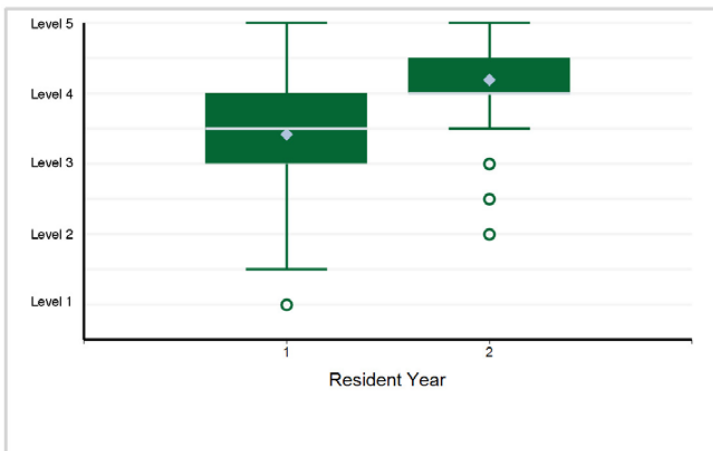

14. Systems-Based Practice - Systems-Based Practice 5: Physician Role in Health Care Systems

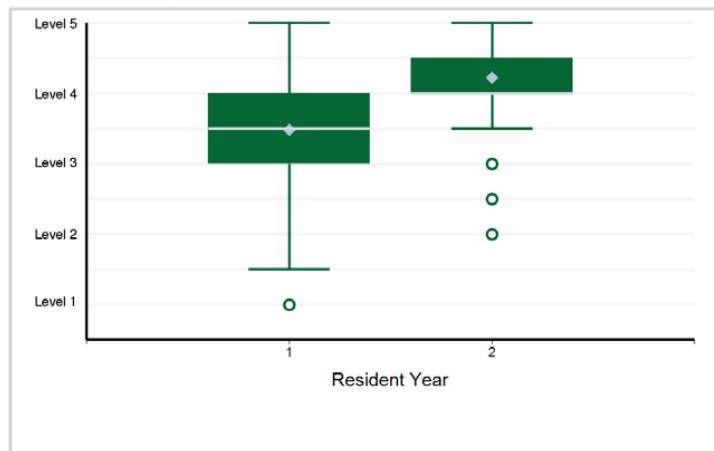

15. Practice-Based Learning and Improvement - Practice-Based Learning and Improvement 1: Evidence-Based and Informed Practice

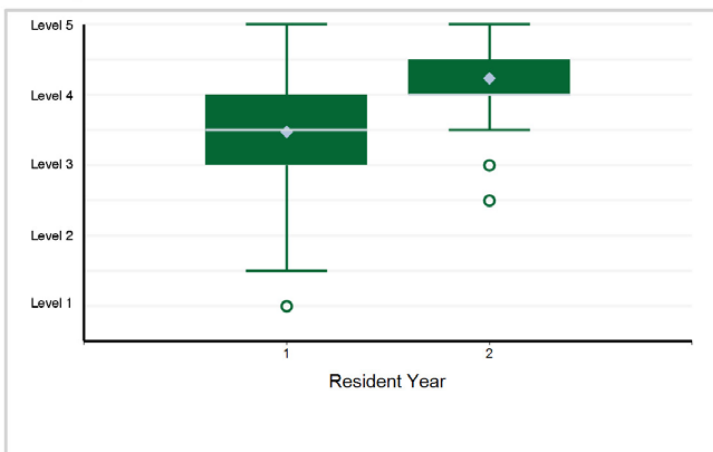

16. Practice-Based Learning and Improvement - Practice-Based Learning and Improvement 2: Reflective Practice and Commitment ...

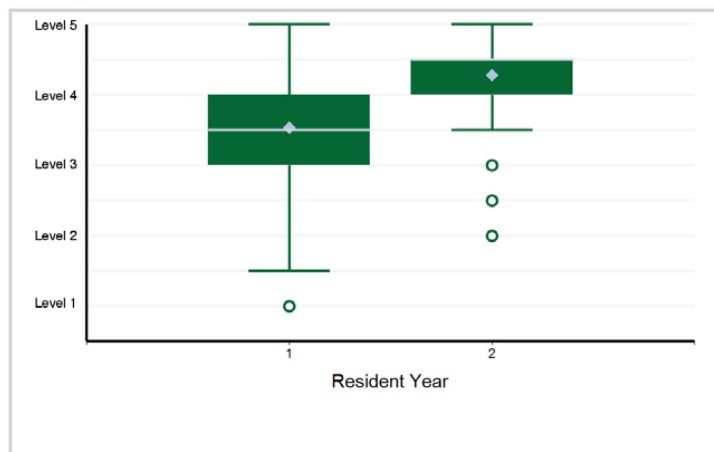

17. Professionalism - Professionalism 1: Professional Behavior

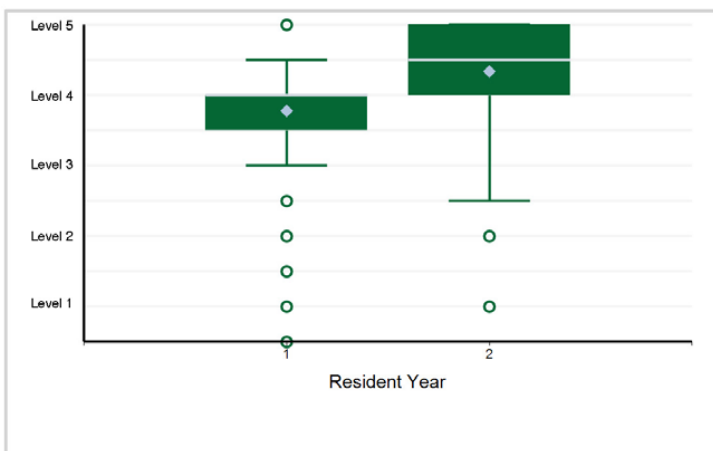

18. Professionalism - Professionalism 2: Ethical Principles

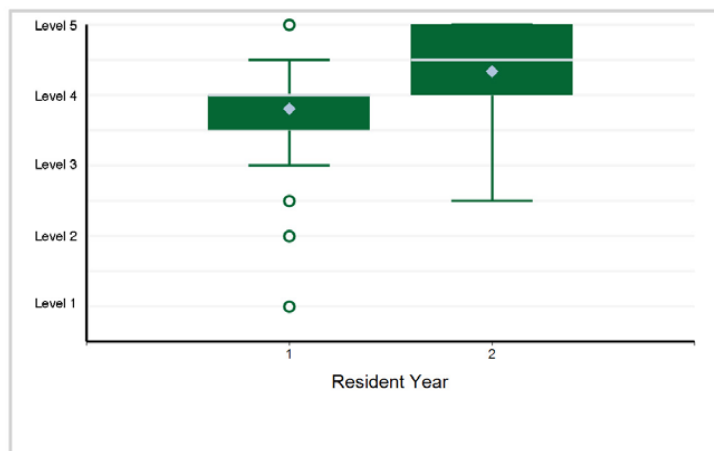

Specialty Box Plot Report - Milestone Evaluation by Resident Year: Year-End 2021-2022

SUBSPECIALTY: Infectious Disease

19. Professionalism - Professionalism 3: Accountability/Conscientiousness

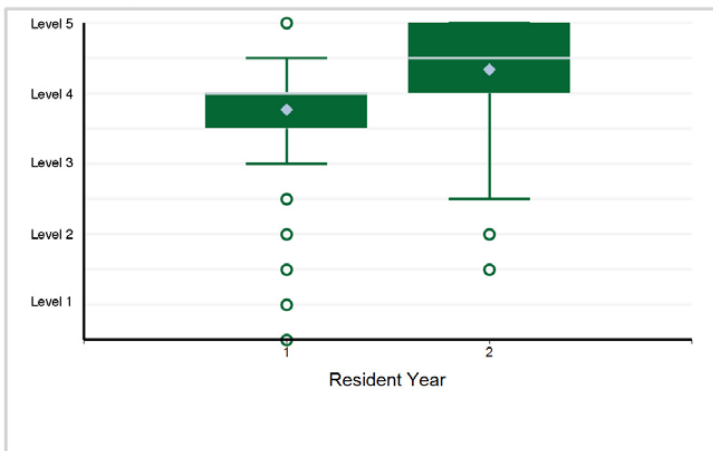

20. Professionalism - Professionalism 4: Well-Being

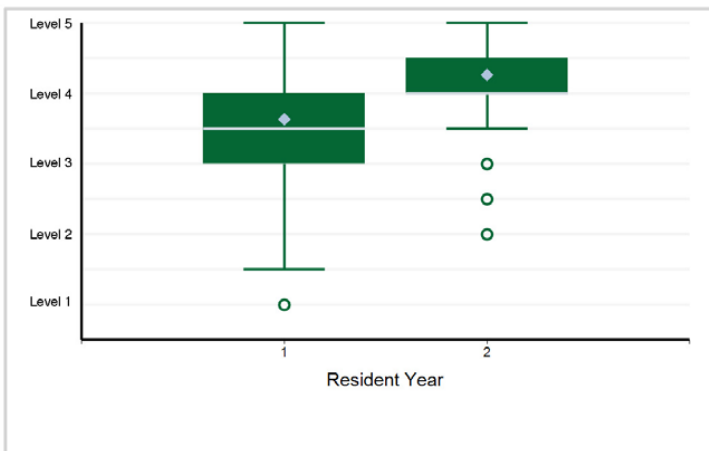

21. Interpersonal and Communication Skills - Interpersonal and Communication Skills 1: Patient- and Family-Centered Communication

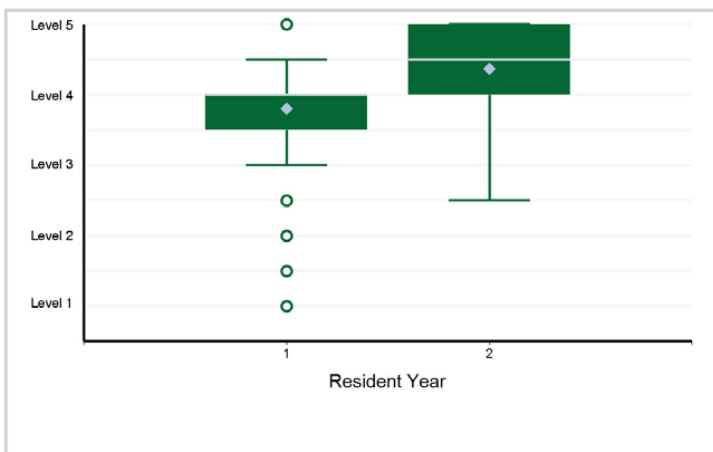

22. Interpersonal and Communication Skills - Interpersonal and Communication Skills 2: Interprofessional and Team Communication

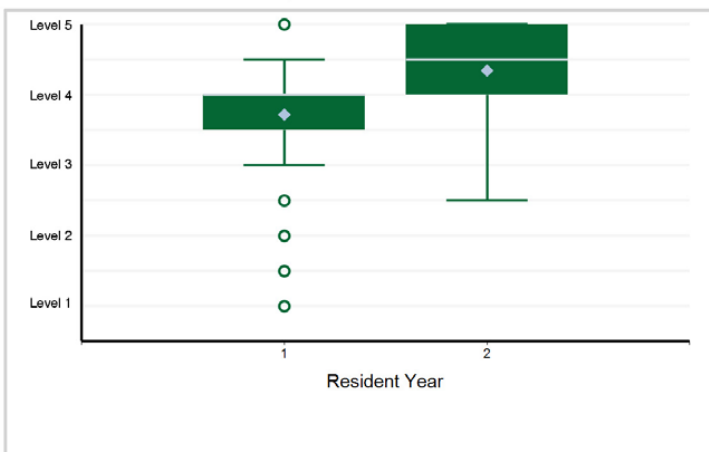

23. Interpersonal and Communication Skills - Interpersonal and Communication Skills 3: Communication within Health Care Systems

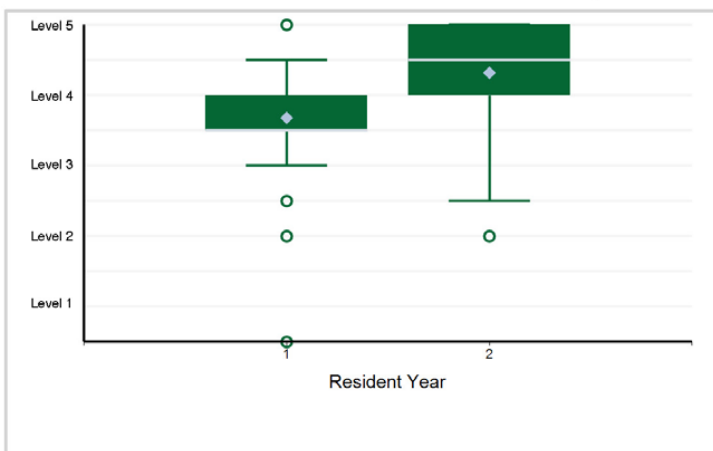

Specialty Box Plot Report - Milestone Evaluation by Resident Year: Year-End 2021-2022

TABLE 41: SUBSPECIALTY: **Interventional Cardiology**

Resident Year	1	Total Residents*
# of Residents	359	359

*Note: There are 3 residents with an incomplete milestone evaluation that are excluded from the box plots below.

1. Patient Care - Patient Care 1: Pre-Procedural Care and Procedural Selection

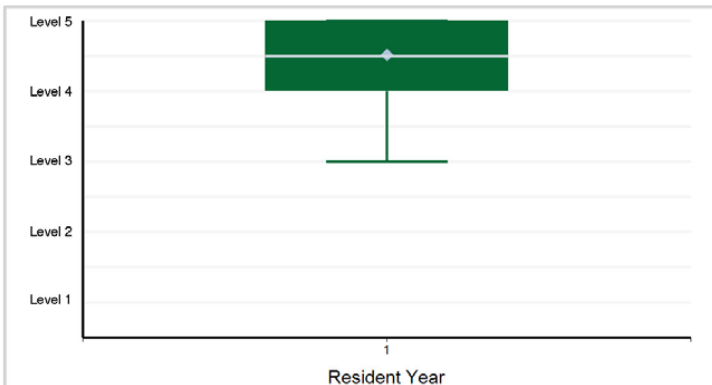

Note: 2 of 356 residents have a status of "Not Yet Assessable" and are not included in the analysis.

2. Patient Care - Patient Care 2: Technical Skills for Percutaneous Intervention

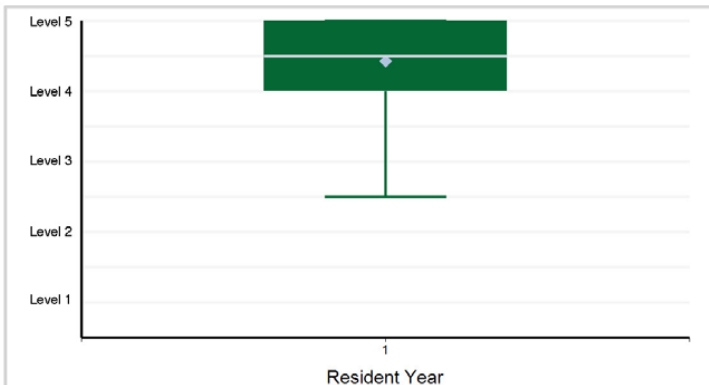

Note: 2 of 356 residents have a status of "Not Yet Assessable" and are not included in the analysis.

3. Patient Care - Patient Care 3: Post-Procedural Management (Inpatient and Outpatient)

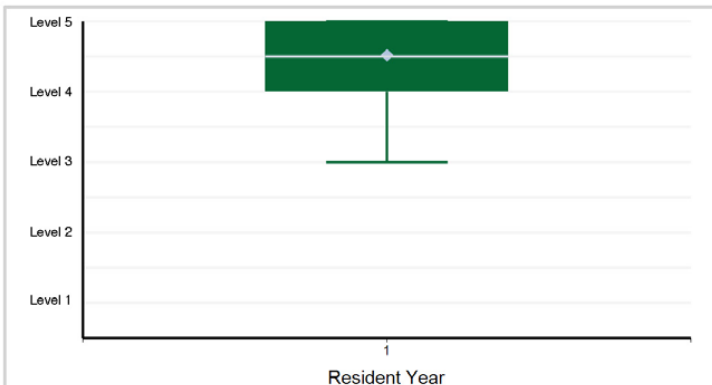

Note: 1 of 356 residents have a status of "Not Yet Assessable" and are not included in the analysis.

4. Medical Knowledge - Medical Knowledge 1: Anatomy and Physiology

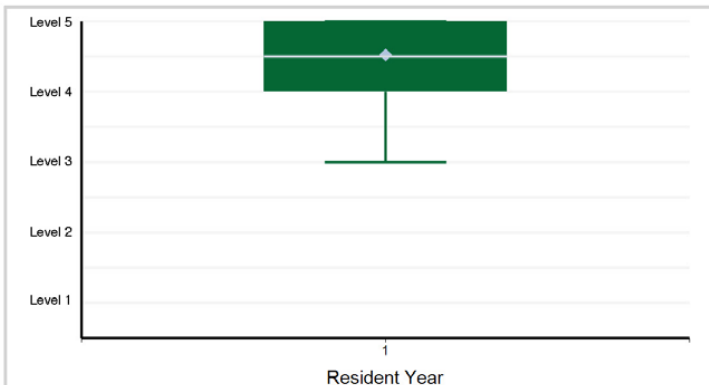

Note: 3 of 356 residents have a status of "Not Yet Assessable" and are not included in the analysis.

5. Medical Knowledge - Medical Knowledge 2: Pharmacology

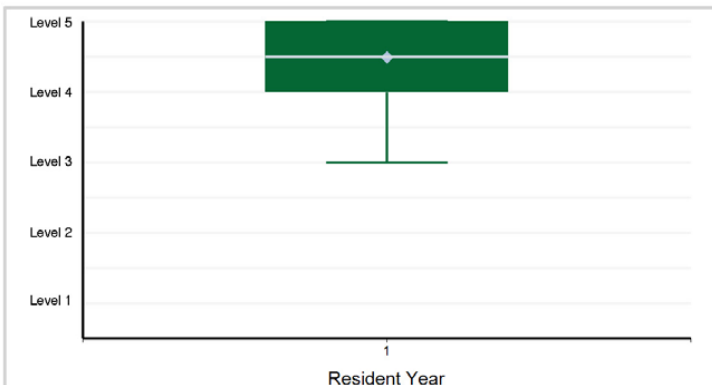

Note: 2 of 356 residents have a status of "Not Yet Assessable" and are not included in the analysis.

6. Medical Knowledge - Medical Knowledge 3: Devices, Techniques, and Outcomes

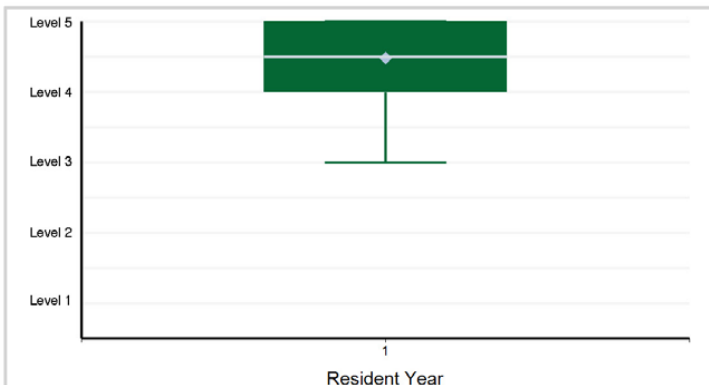

Note: 2 of 356 residents have a status of "Not Yet Assessable" and are not included in the analysis.

Specialty Box Plot Report - Milestone Evaluation by Resident Year: Year-End 2021-2022

SUBSPECIALTY: Interventional Cardiology

7. Systems-Based Practice - Systems-Based Practice 1: Patient Safety and Quality Improvement

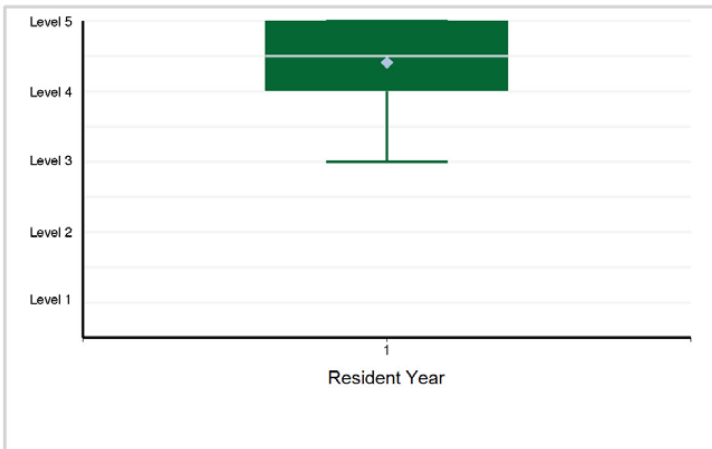

8. Systems-Based Practice - Systems-Based Practice 2: System Navigation for Patient-Centered Care

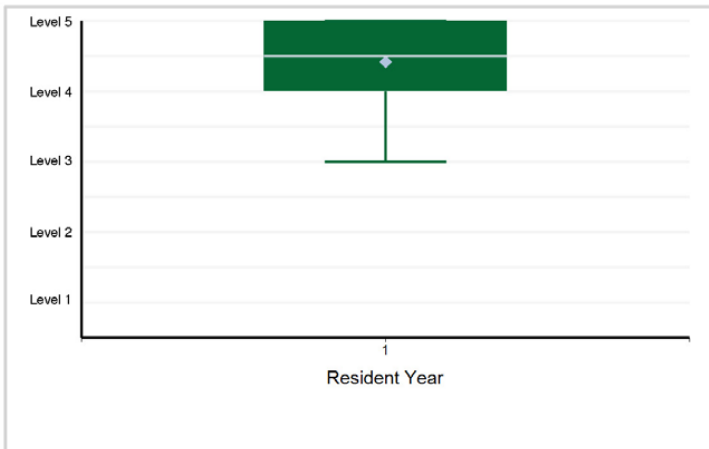

9. Systems-Based Practice - Systems-Based Practice 3: Physician Role in Health Care Systems

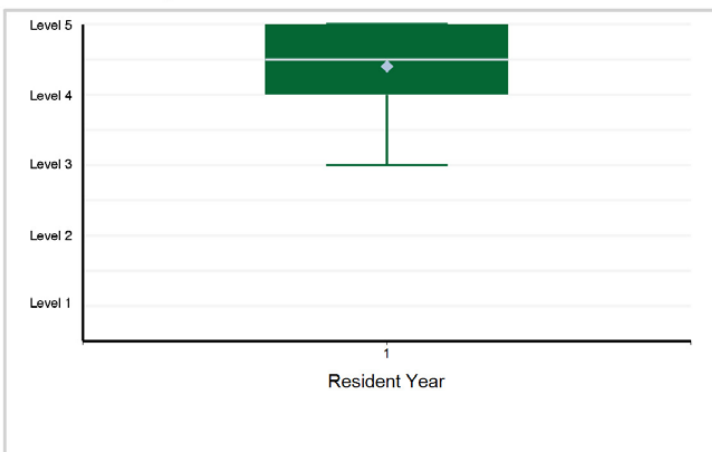

10. Practice-Based Learning and Improvement - Practice-Based Learning and Improvement 1: Evidence-Based and Informed Practice

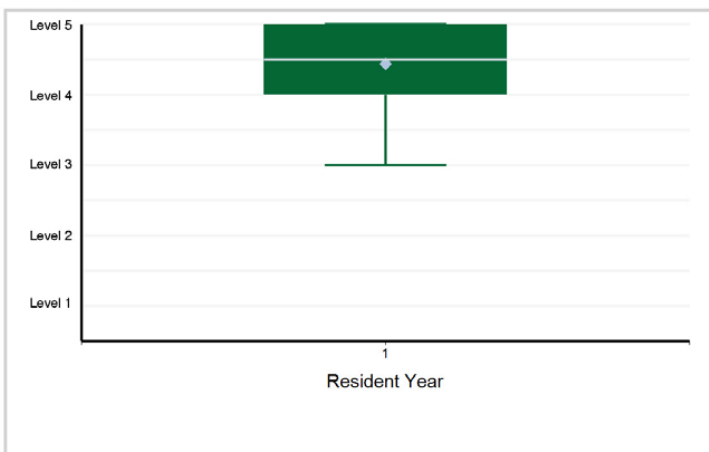

11. Practice-Based Learning and Improvement - Practice-Based Learning and Improvement 2: Reflective Practice and Commitment ...

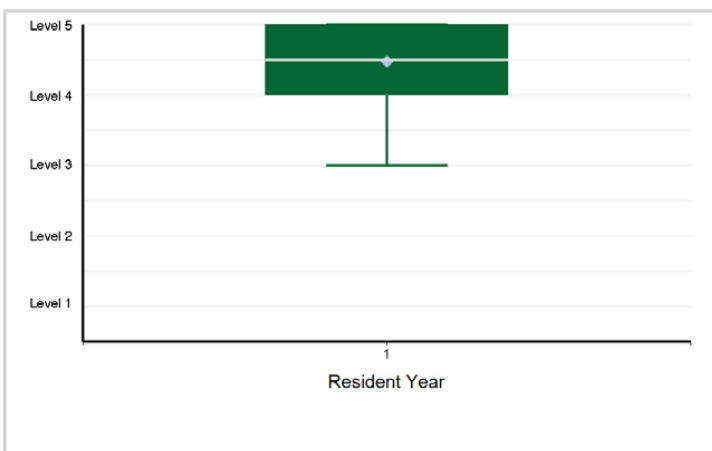

12. Professionalism - Professionalism 1: Professional Behavior and Ethical Principles

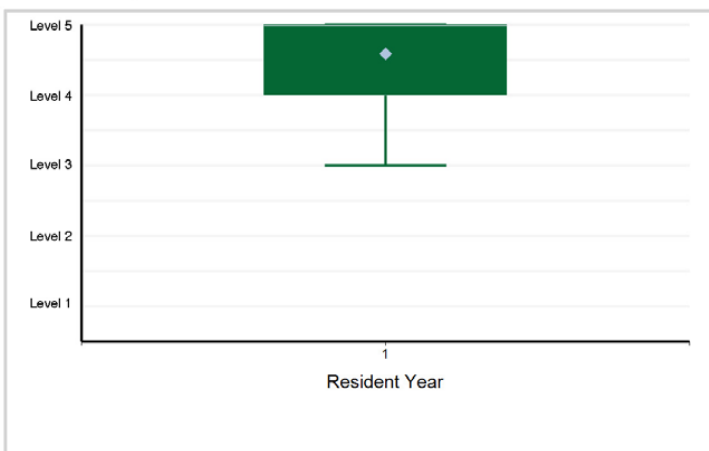

Specialty Box Plot Report - Milestone Evaluation by Resident Year: Year-End 2021-2022

SUBSPECIALTY: Interventional Cardiology

13. Professionalism - Professionalism 2: Accountability/Conscientiousness

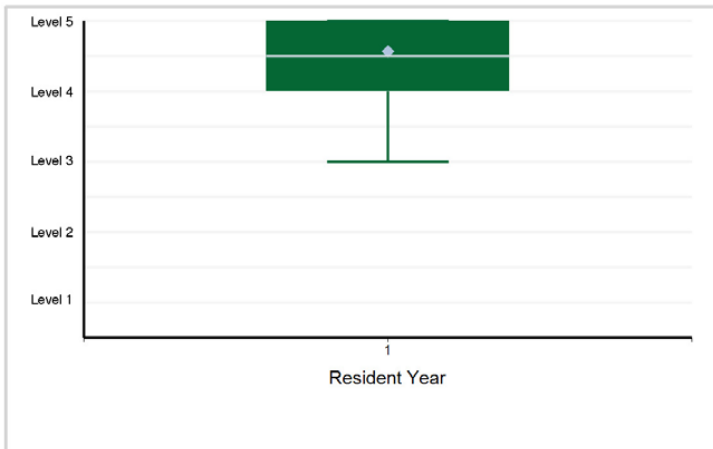

14. Professionalism - Professionalism 3: Self-Awareness and Well-Being

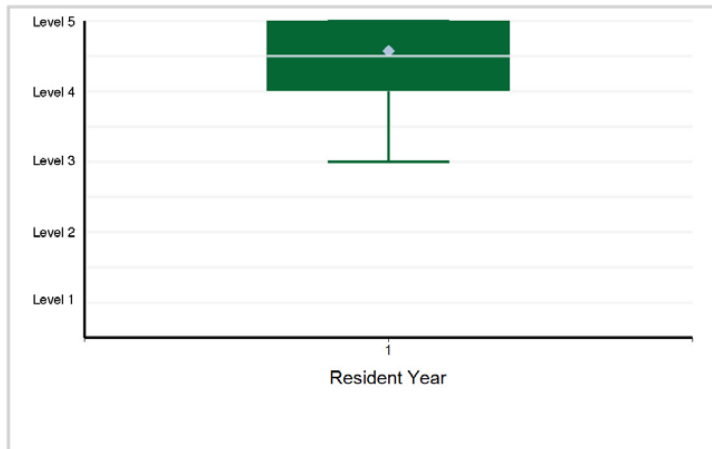

15. Interpersonal and Communication Skills - Interpersonal and Communication Skills 1: Patient- and Family-Centered Communication

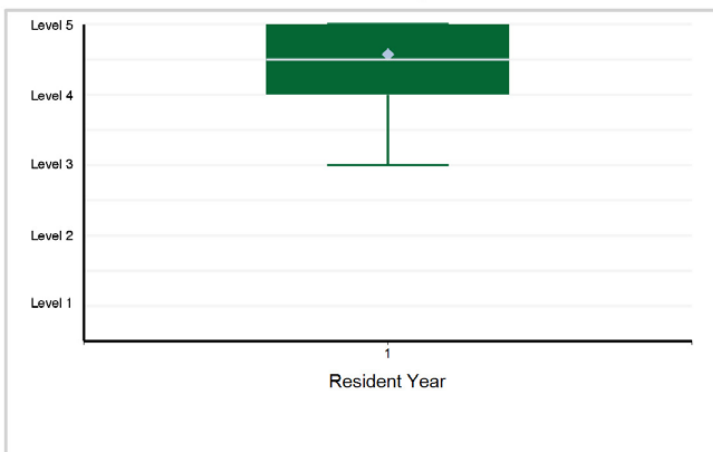

16. Interpersonal and Communication Skills - Interpersonal and Communication Skills 2: Interprofessional and Team Communication

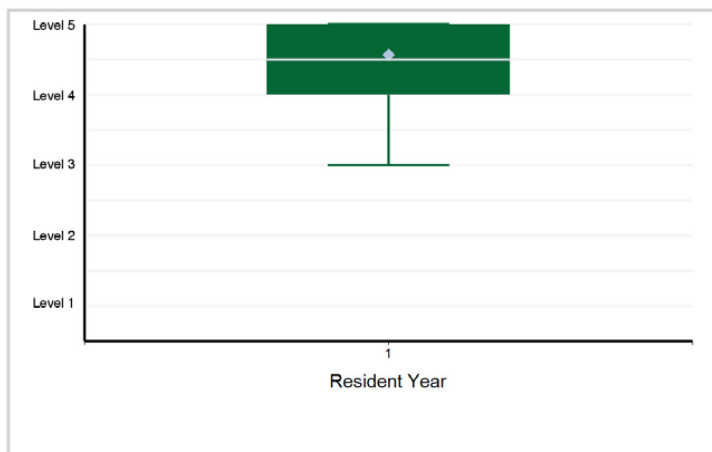

17. Interpersonal and Communication Skills - Interpersonal and Communication Skills 3: Communication within Health Care Systems

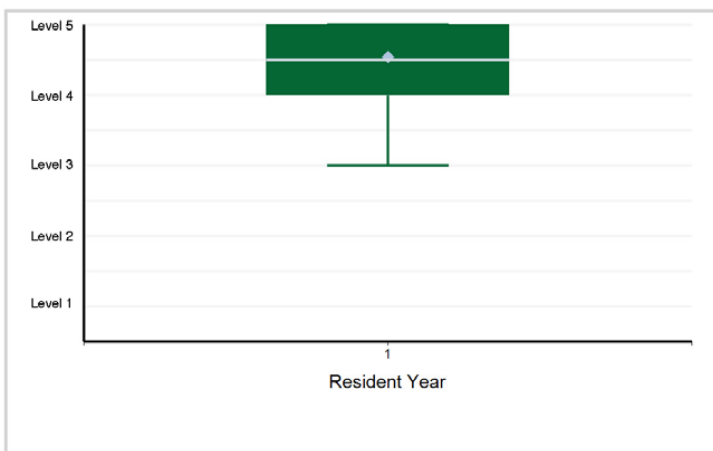

Specialty Box Plot Report - Milestone Evaluation by Resident Year: Year-End 2021-2022

TABLE 42: SUBSPECIALTY: **Medical Oncology**

Resident Year	1	2	Total Residents
# of Residents	18	16	34

1. Patient Care - Patient Care 1: Accesses Data Sources to Synthesize Patient and Disease Specific Information ...

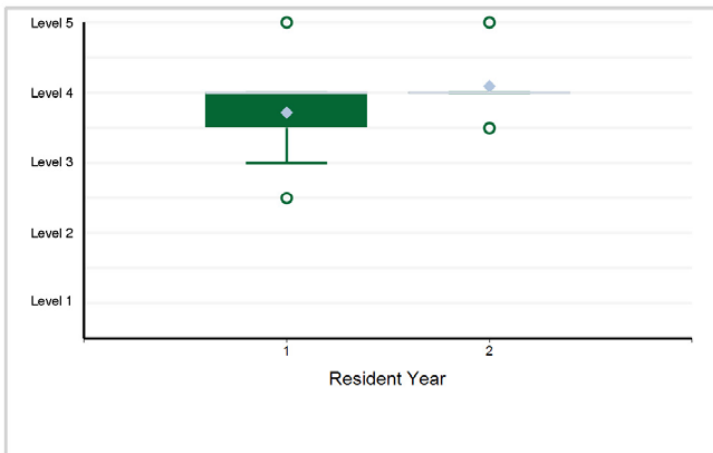

2. Patient Care - Patient Care 2: Diagnoses and Assigns Stage and Severity of Oncology Disorders

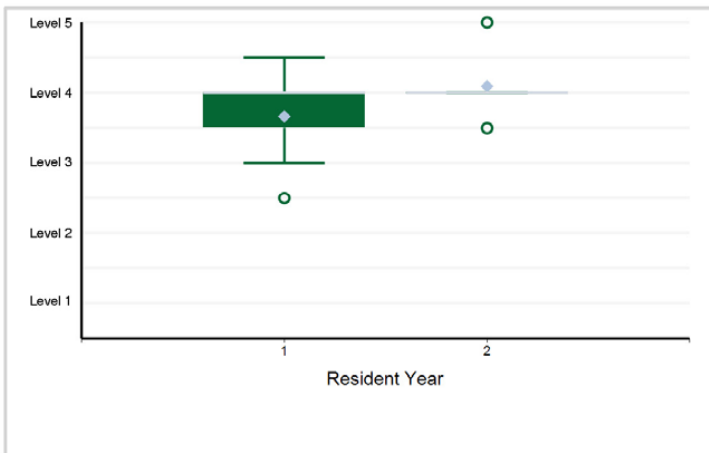

3. Patient Care - Patient Care 3: Formulates the Management Plan

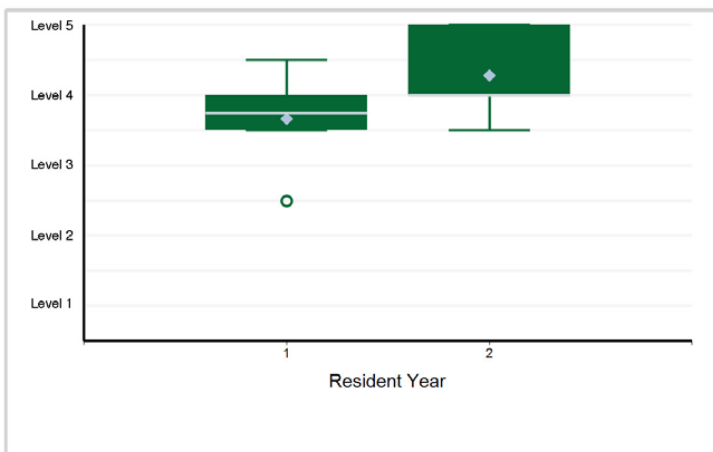

4. Patient Care - Patient Care 4: Adjusts Management Plans for Acute and Chronic Issues

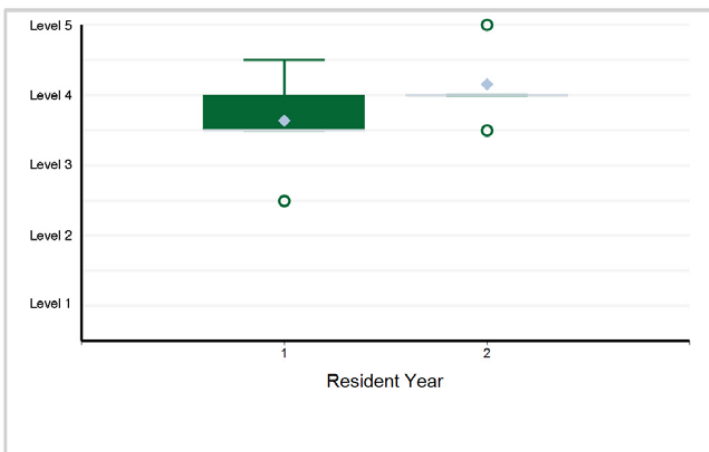

5. Patient Care - Patient Care 5: Competence in Procedures: Performance of Bone Marrow Biopsies and Aspirations

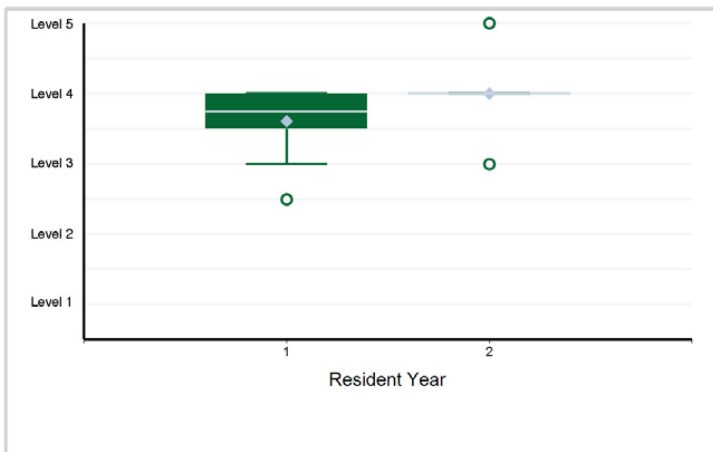

6. Medical Knowledge - Medical Knowledge 1: Malignant Hematology (includes Pathophysiology, Diagnostics, ...)

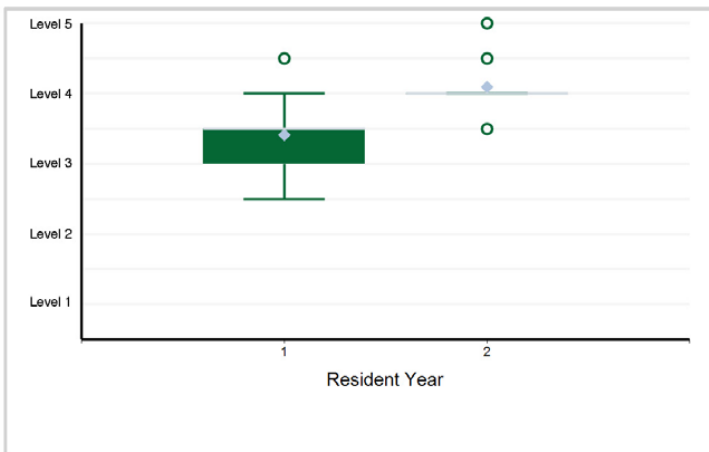

Specialty Box Plot Report - Milestone Evaluation by Resident Year: Year-End 2021-2022

SUBSPECIALTY: Medical Oncology

7. Medical Knowledge - Medical Knowledge 2: Solid Tumor Oncology (includes Pathophysiology, Diagnostics, ...)

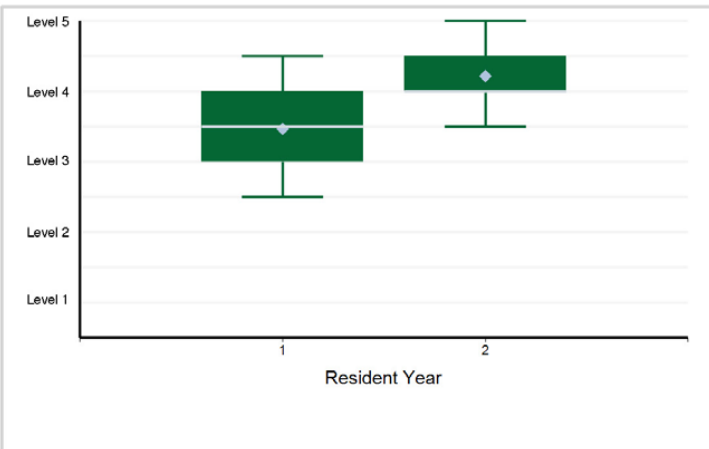

8. Medical Knowledge - Medical Knowledge 3: Scholarly Activity

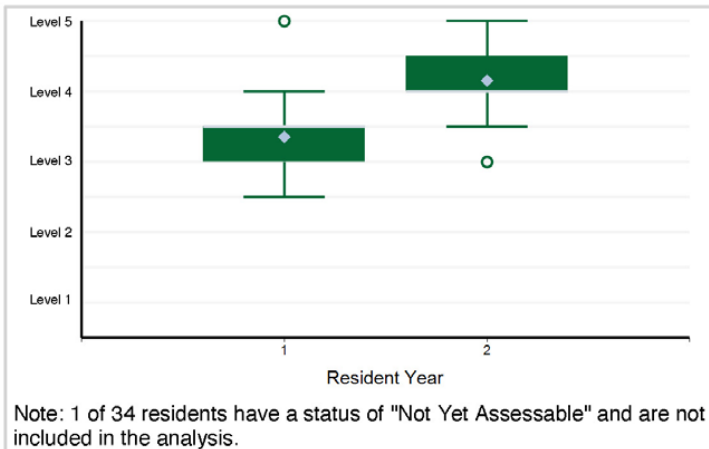

9. Systems-Based Practice - Systems-Based Practice 1: Patient Safety

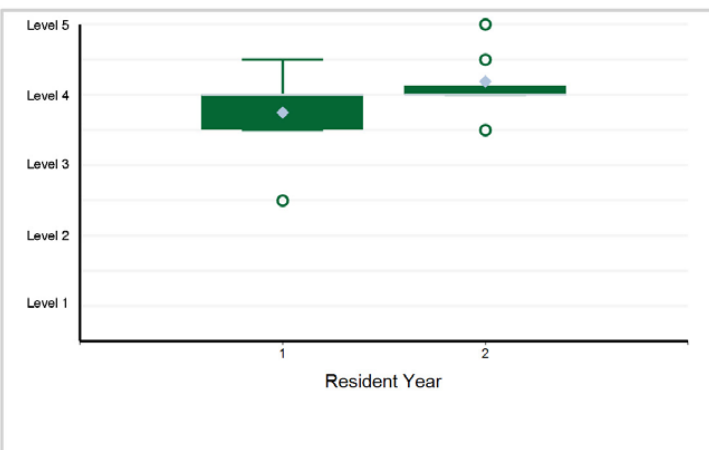

10. Systems-Based Practice - Systems-Based Practice 2: Quality Improvement

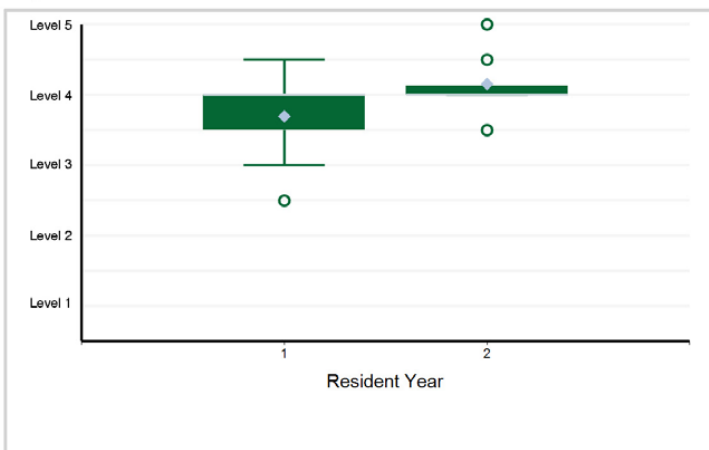

11. Systems-Based Practice - Systems-Based Practice 3: System Navigation for Patient-Centered Care: Coordination ...

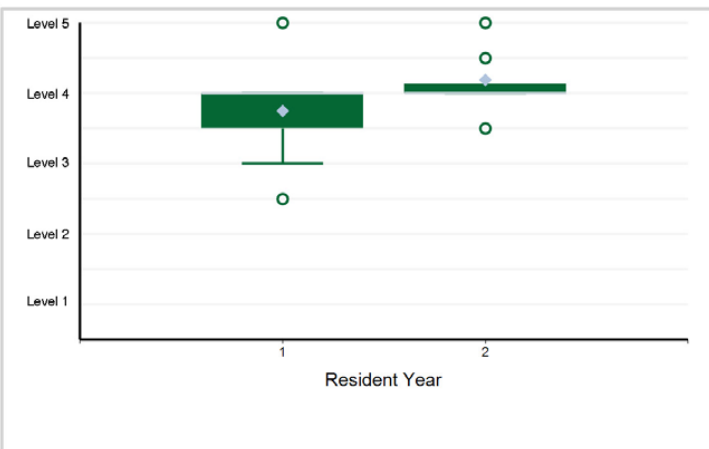

12. Systems-Based Practice - Systems-Based Practice 4: System Navigation for Patient-Centered Care: Population Health

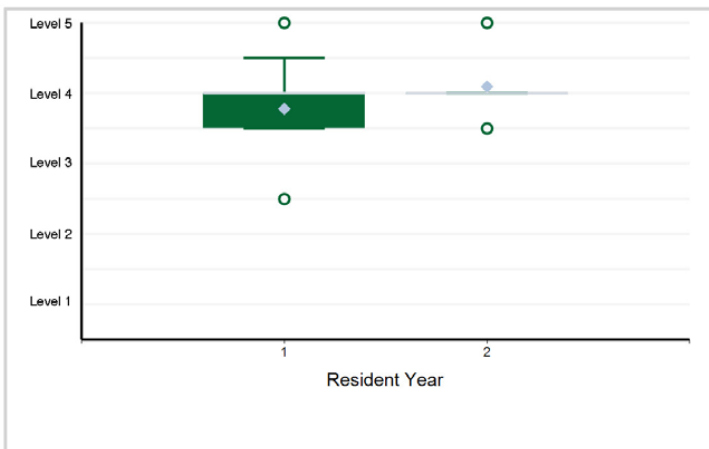

Specialty Box Plot Report - Milestone Evaluation by Resident Year: Year-End 2021-2022

SUBSPECIALTY: Medical Oncology

13. Systems-Based Practice - Systems-Based Practice 5: Physician Role in Health Care Systems

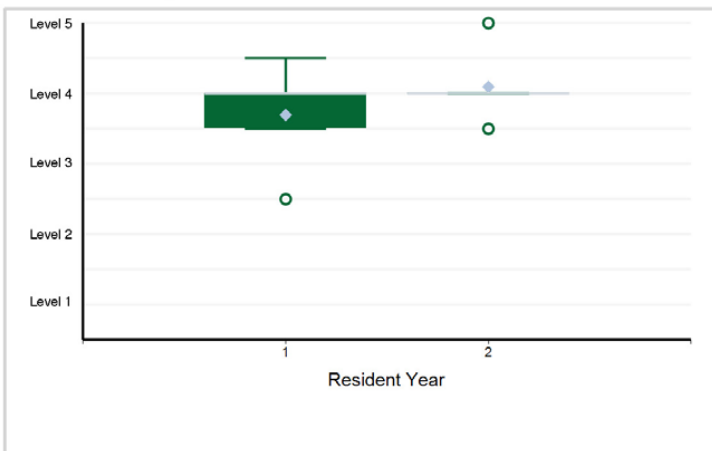

14. Practice-Based Learning and Improvement - Practice-Based Learning and Improvement 1: Evidence-Based and Informed Practice

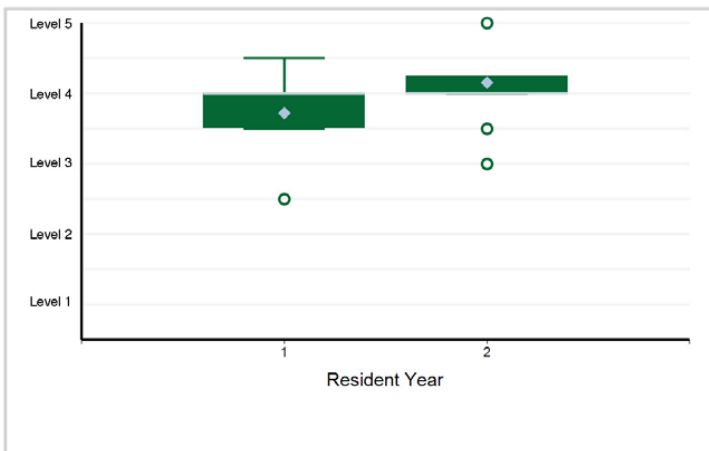

15. Practice-Based Learning and Improvement - Practice-Based Learning and Improvement 2: Reflective Practice and Commitment ...

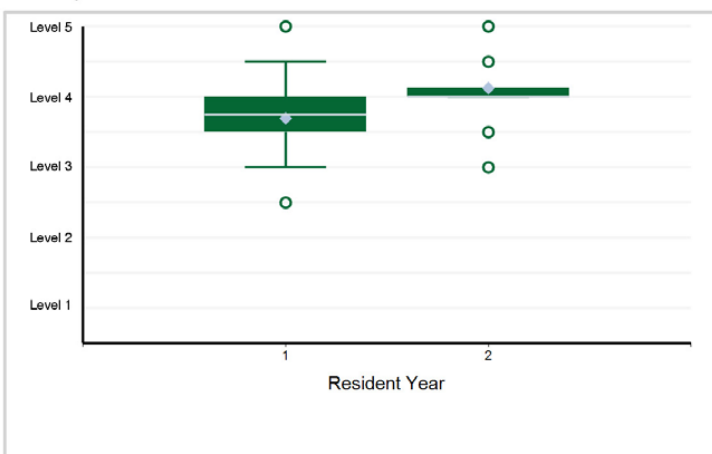

16. Professionalism - Professionalism 1: Professional Behavior and Ethical Principles

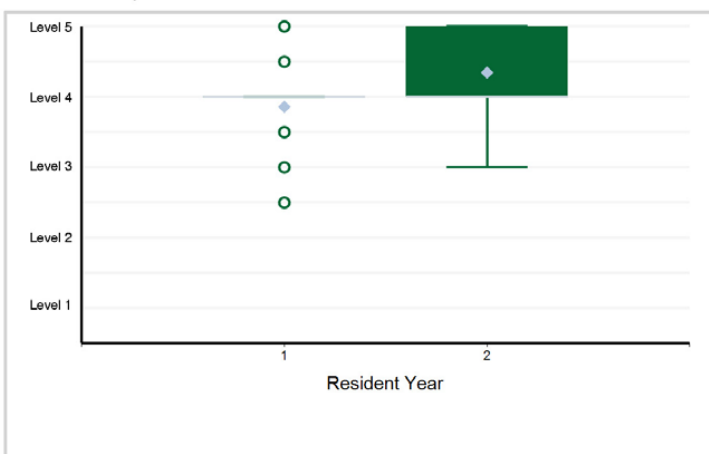

17. Professionalism - Professionalism 2: Accountability/Conscientiousness

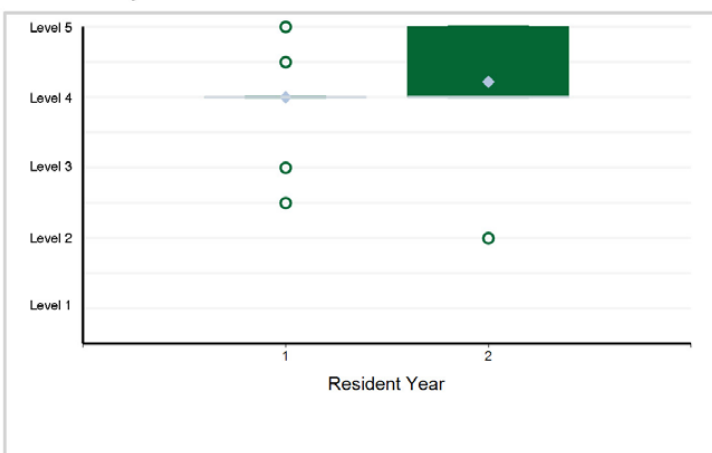

18. Professionalism - Professionalism 3: Fellow Well-Being

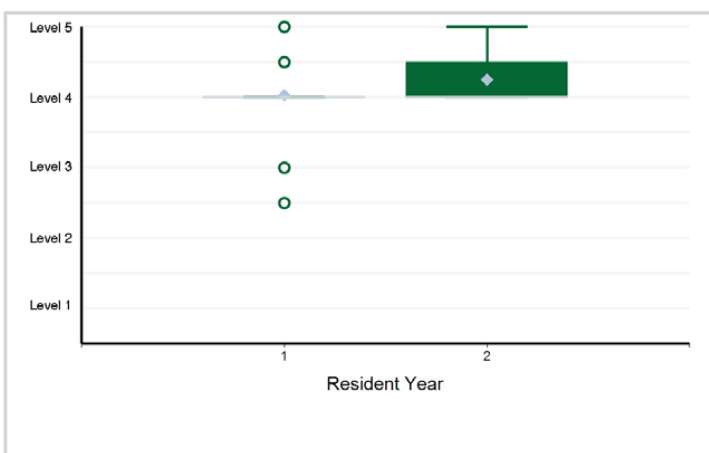

Specialty Box Plot Report - Milestone Evaluation by Resident Year: Year-End 2021-2022

SUBSPECIALTY: Medical Oncology

19. Interpersonal and Communication Skills - Interpersonal and Communication Skills 1: Patient- and Family-Centered Communication

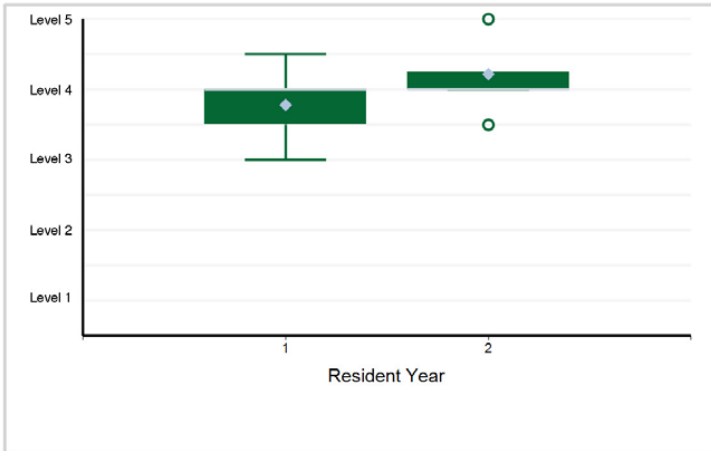

20. Interpersonal and Communication Skills - Interpersonal and Communication Skills 2: Interprofessional and Team Communication

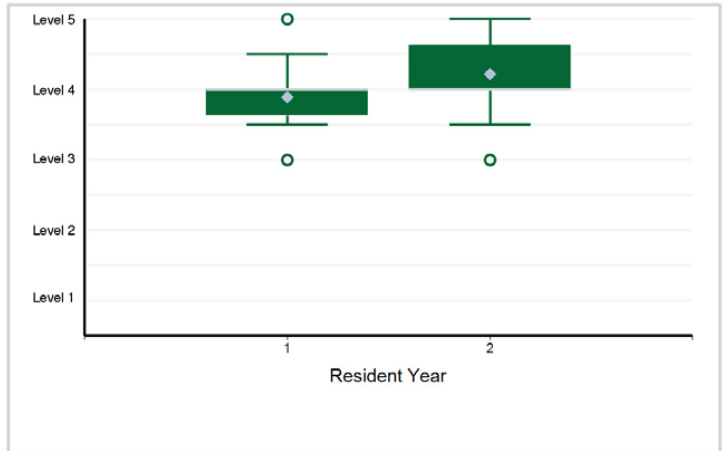

21. Interpersonal and Communication Skills - Interpersonal and Communication Skills 3: Communication within Health Care Systems

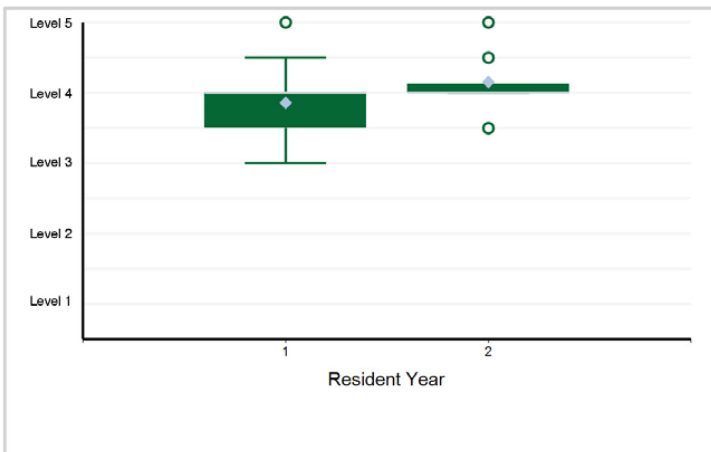

Specialty Box Plot Report - Milestone Evaluation by Resident Year: Year-End 2021-2022

TABLE 43: SUBSPECIALTY: **Nephrology**

Resident Year	1	2	Total Residents
# of Residents	449	419	868

1. Patient Care - Patient Care 1: Acute Kidney Injury

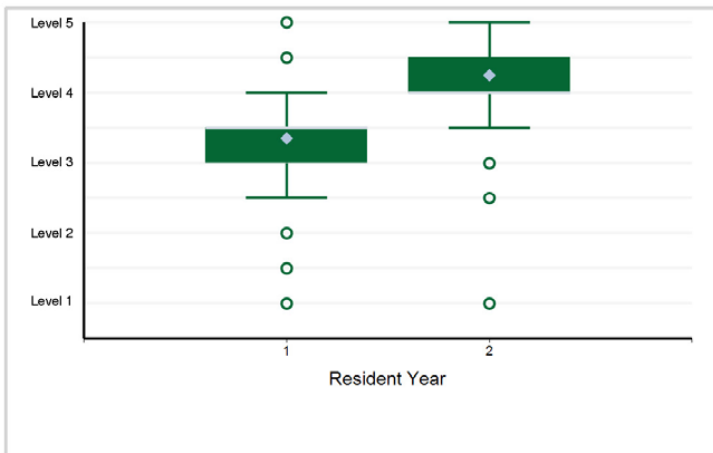

2. Patient Care - Patient Care 2: Chronic Dialysis Therapy

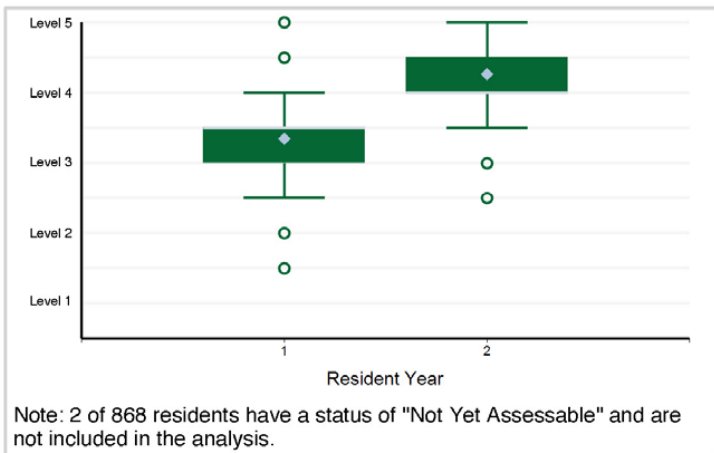

3. Patient Care - Patient Care 3: Chronic Kidney Disease

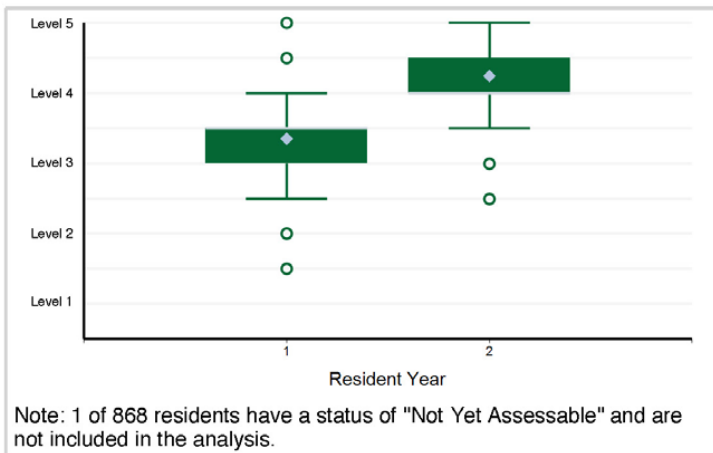

4. Patient Care - Patient Care 4: Transplant

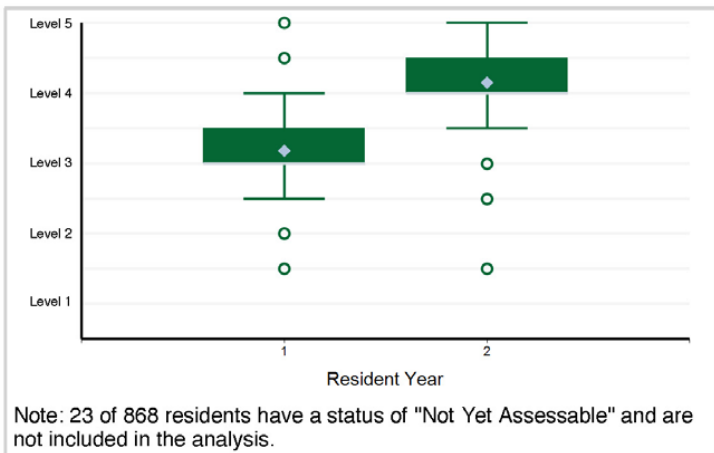

5. Patient Care - Patient Care 5: Fluid and Electrolytes

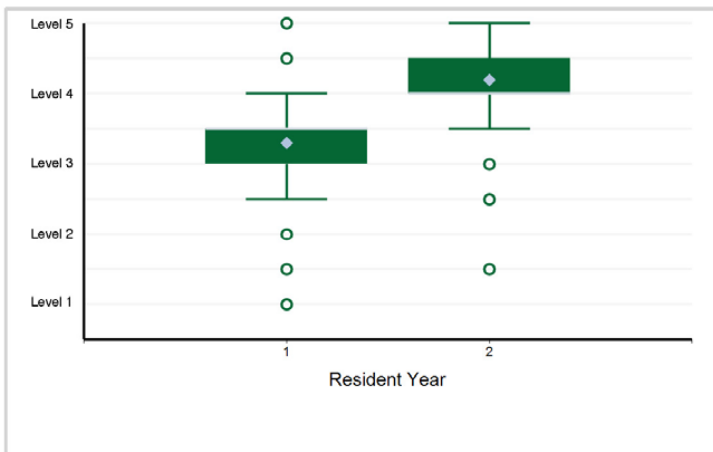

6. Patient Care - Patient Care 6: Hypertension

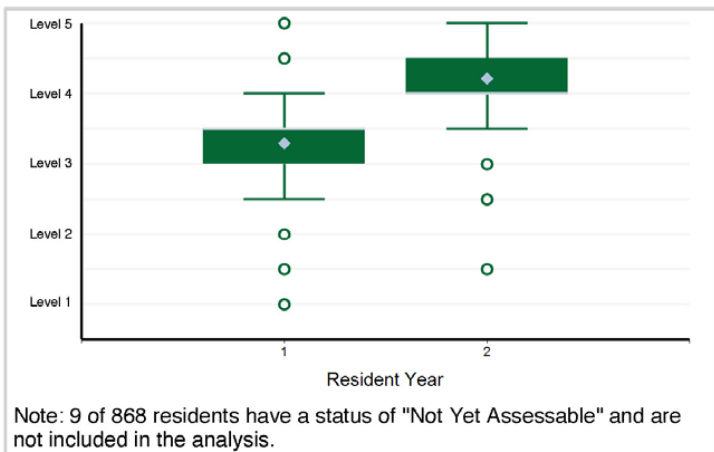

Specialty Box Plot Report - Milestone Evaluation by Resident Year: Year-End 2021-2022

SUBSPECIALTY: Nephrology

7. Patient Care - Patient Care 7: Competence in Procedures

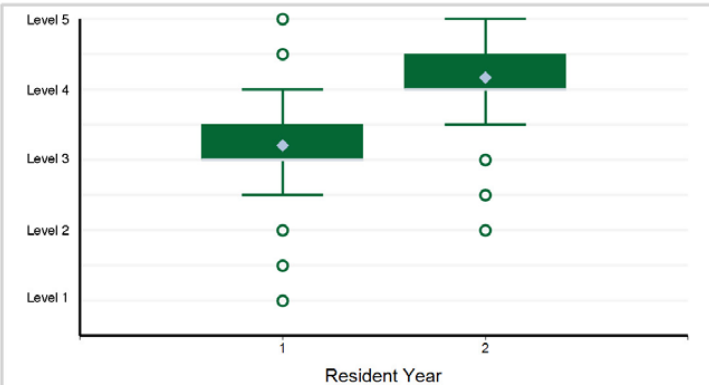

Note: 46 of 868 residents have a status of "Not Yet Assessable" and are not included in the analysis.

8. Medical Knowledge - Medical Knowledge 1: Physiology and Pathophysiology

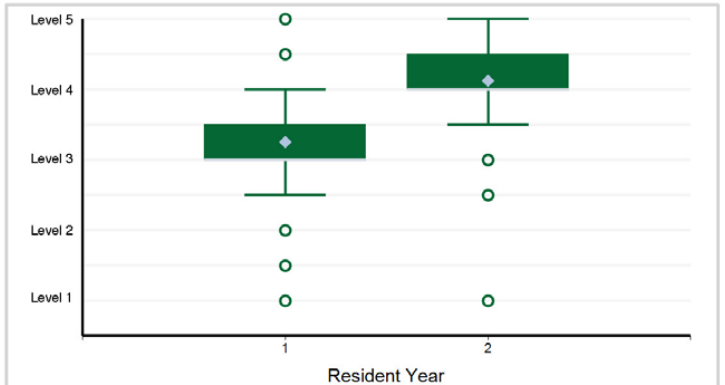

Note: 1 of 868 residents have a status of "Not Yet Assessable" and are not included in the analysis.

9. Medical Knowledge - Medical Knowledge 2: Pharmacology and Therapeutics

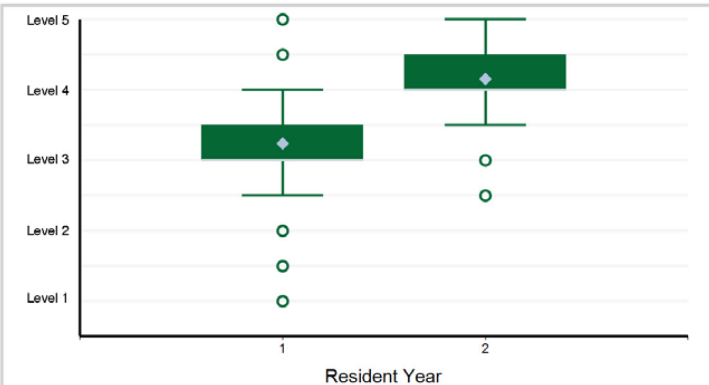

Note: 1 of 868 residents have a status of "Not Yet Assessable" and are not included in the analysis.

10. Medical Knowledge - Medical Knowledge 3: Diagnostic Testing in Kidney Disease

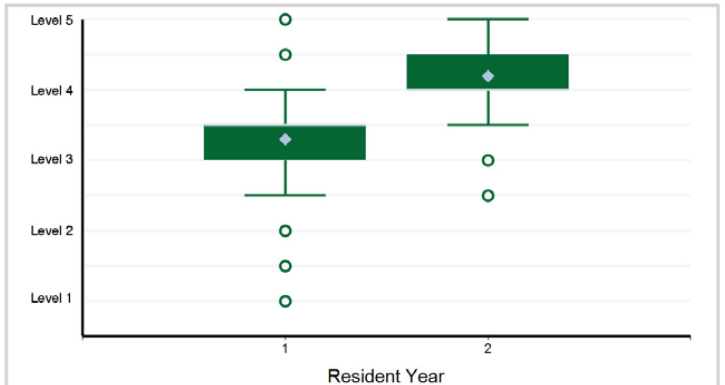

Note: 2 of 868 residents have a status of "Not Yet Assessable" and are not included in the analysis.

11. Systems-Based Practice - Systems-Based Practice 1: Patient Safety and Quality Improvement

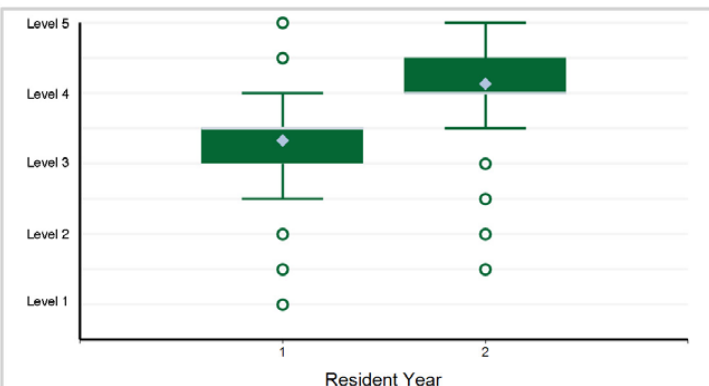

12. Systems-Based Practice - Systems-Based Practice 2: System Navigation for Patient-Centered Care

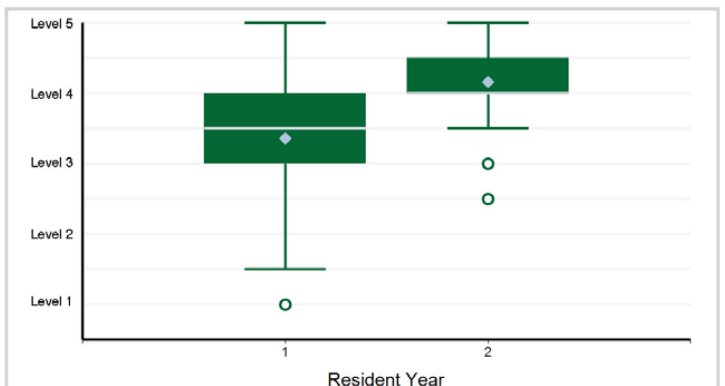

Specialty Box Plot Report - Milestone Evaluation by Resident Year: Year-End 2021-2022

SUBSPECIALTY: Nephrology

13. Systems-Based Practice - Systems-Based Practice 3: Population Health

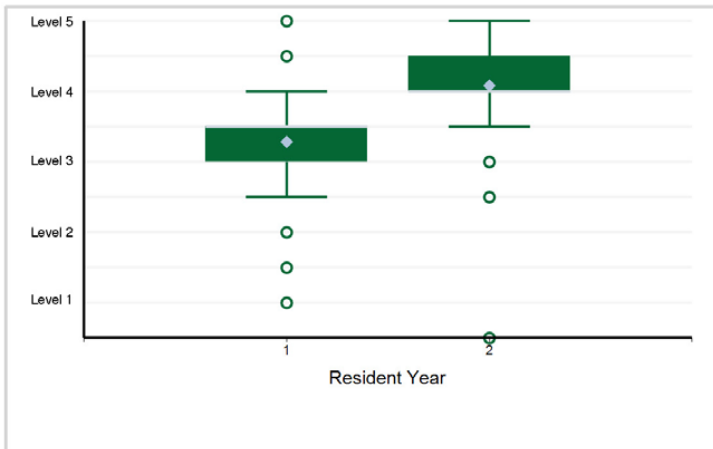

14. Systems-Based Practice - Systems-Based Practice 4: Physician Role in Health Care Systems

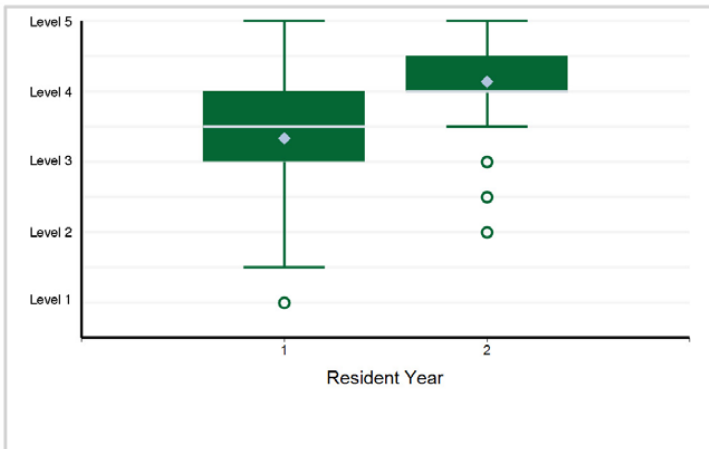

15. Practice-Based Learning and Improvement - Practice-Based Learning and Improvement 1: Evidence-Based and Informed Practice

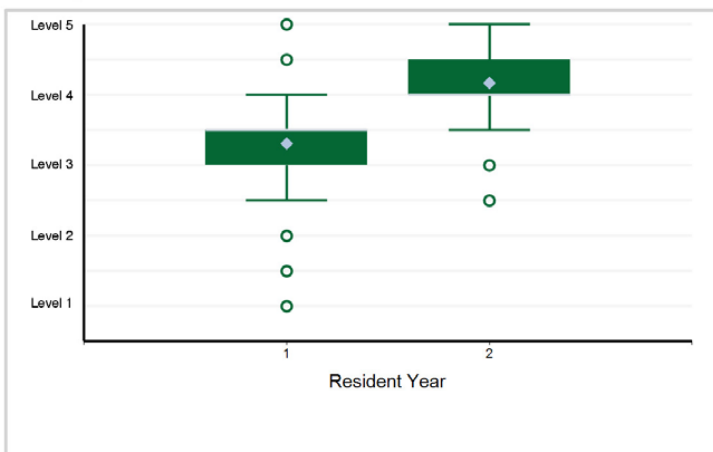

16. Practice-Based Learning and Improvement - Practice-Based Learning and Improvement 2: Reflective Practice and Commitment ...

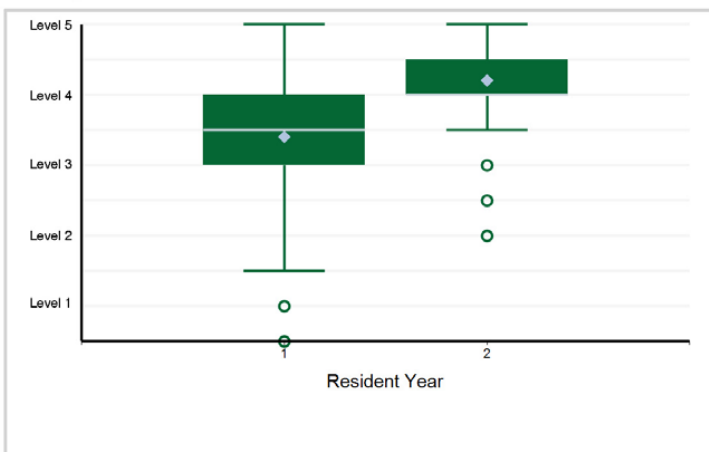

17. Professionalism - Professionalism 1: Professional Behavior and Ethical Principles

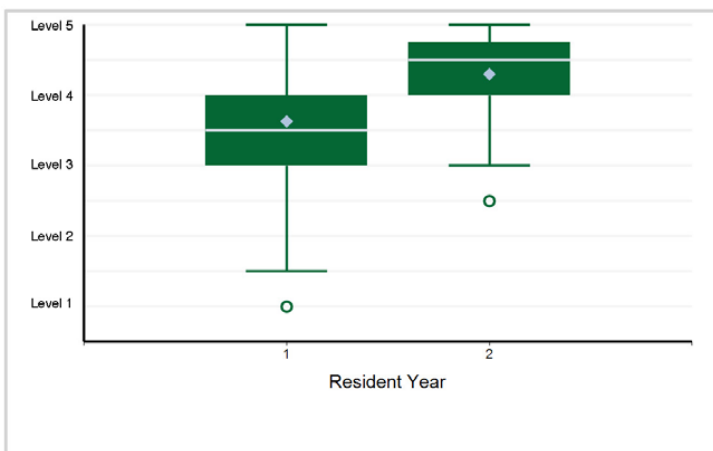

18. Professionalism - Professionalism 2: Accountability/Conscientiousness

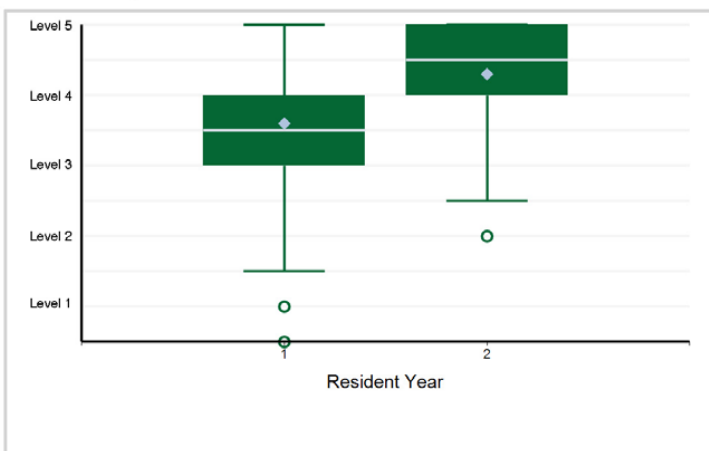

Specialty Box Plot Report - Milestone Evaluation by Resident Year: Year-End 2021-2022

SUBSPECIALTY: Nephrology

19. Professionalism - Professionalism 3: Self-Awareness and Well-Being

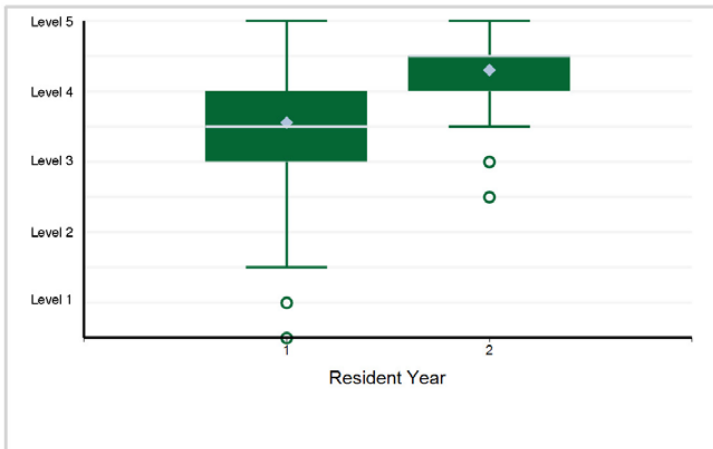

20. Interpersonal and Communication Skills - Interpersonal and Communication Skills 1: Patient- and Family-Centered Communication

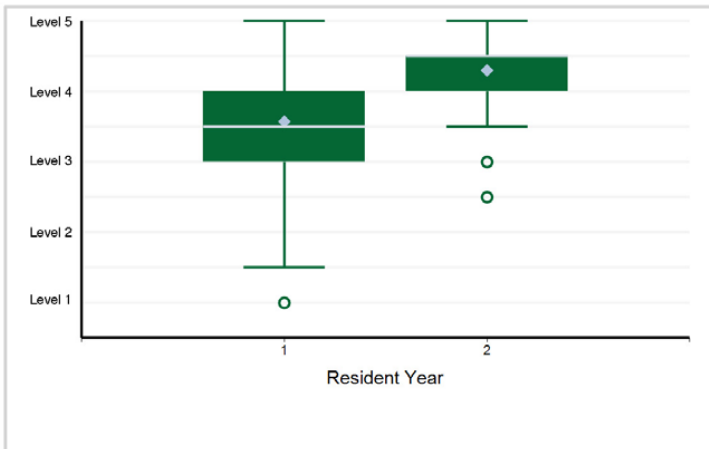

21. Interpersonal and Communication Skills - Interpersonal and Communication Skills 2: Interprofessional and Team Communication

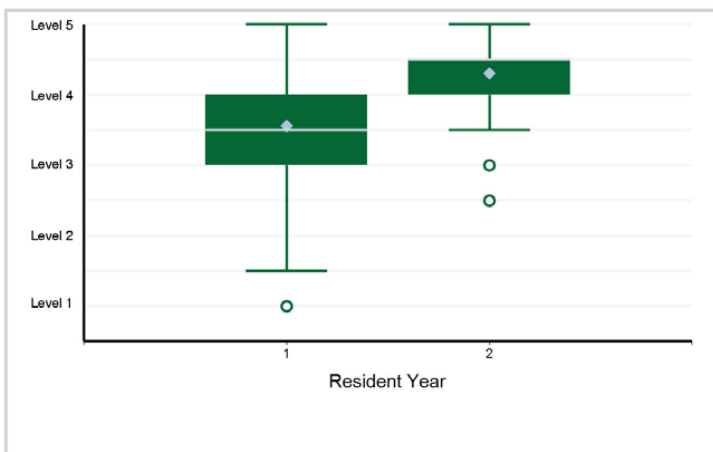

22. Interpersonal and Communication Skills - Interpersonal and Communication Skills 3: Communication within Health Care Systems

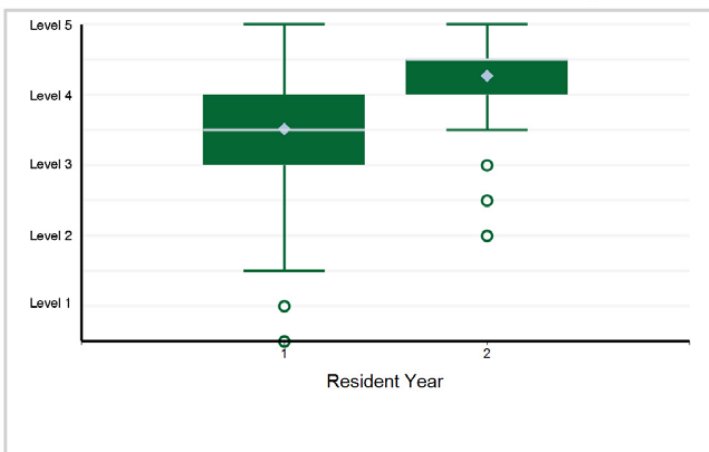

Specialty Box Plot Report - Milestone Evaluation by Resident Year: Year-End 2021-2022

TABLE 44: SUBSPECIALTY: **Pulmonary Disease**

Resident Year	1	2	Total Residents
# of Residents	34	34	68

1. Patient Care - Patient Care 1: History and Physical Examination

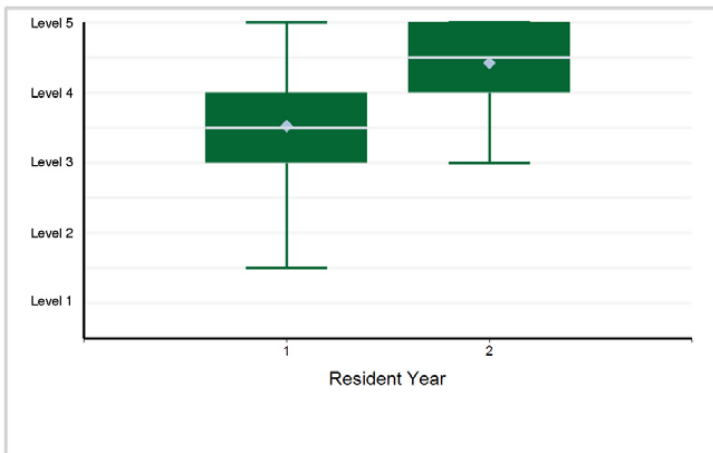

2. Patient Care - Patient Care 2: Disease Management in Pulmonary Medicine

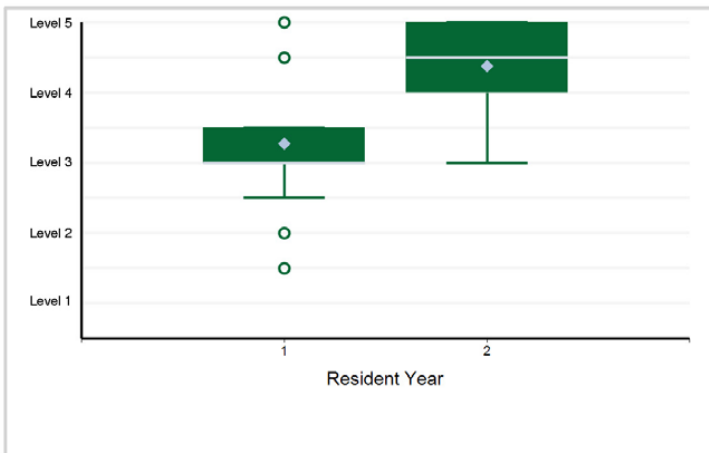

3. Patient Care - Patient Care 3: Pre-Procedure Assessment

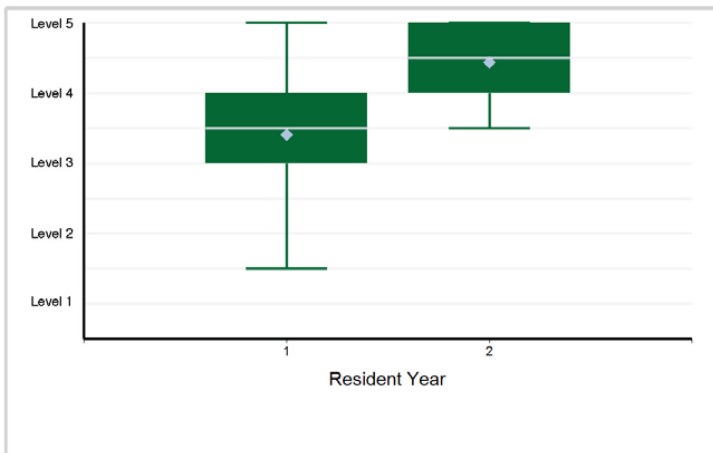

4. Patient Care - Patient Care 4: Procedures (Invasive and Non-Invasive)

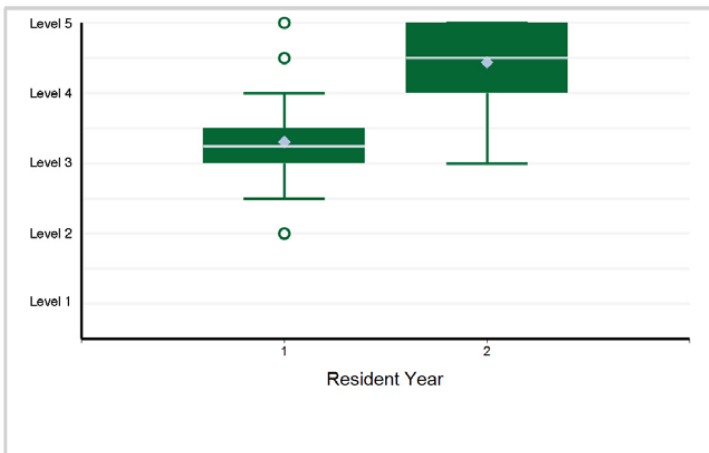

5. Medical Knowledge - Medical Knowledge 1: Clinical Reasoning

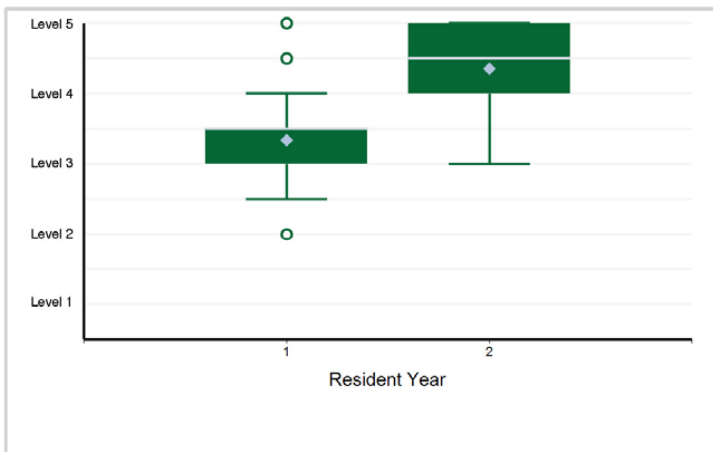

6. Medical Knowledge - Medical Knowledge 2: Scientific Knowledge of Disease and Therapeutics

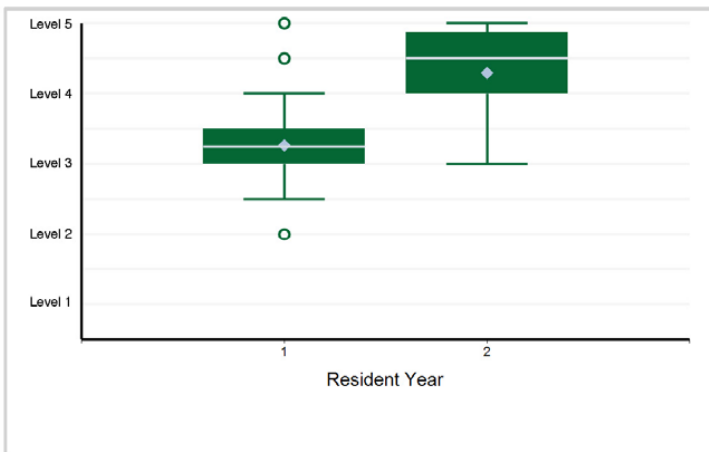

Specialty Box Plot Report - Milestone Evaluation by Resident Year: Year-End 2021-2022

SUBSPECIALTY: Pulmonary Disease

7. Systems-Based Practice - Systems-Based Practice 1: Patient Safety and Quality Improvement

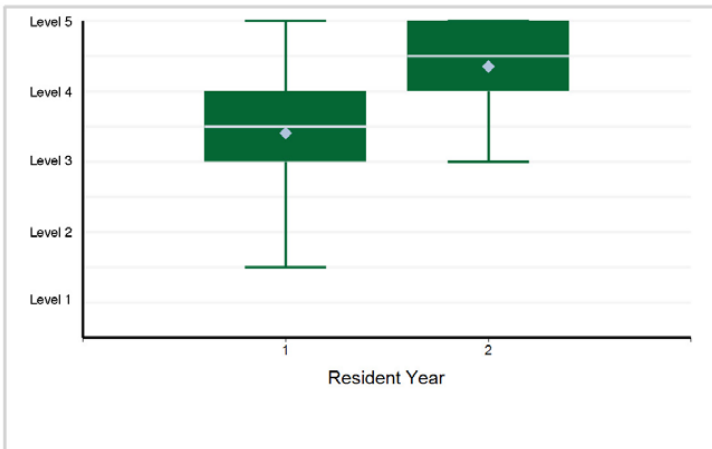

8. Systems-Based Practice - Systems-Based Practice 2: Coordination and Transition of Care

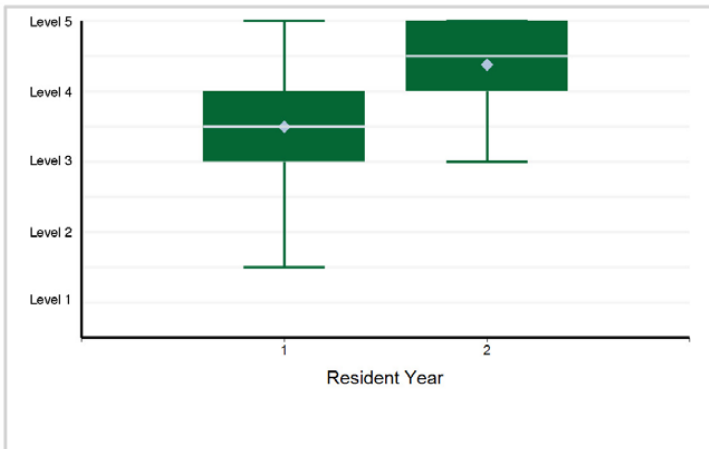

9. Systems-Based Practice - Systems-Based Practice 3: Population Health

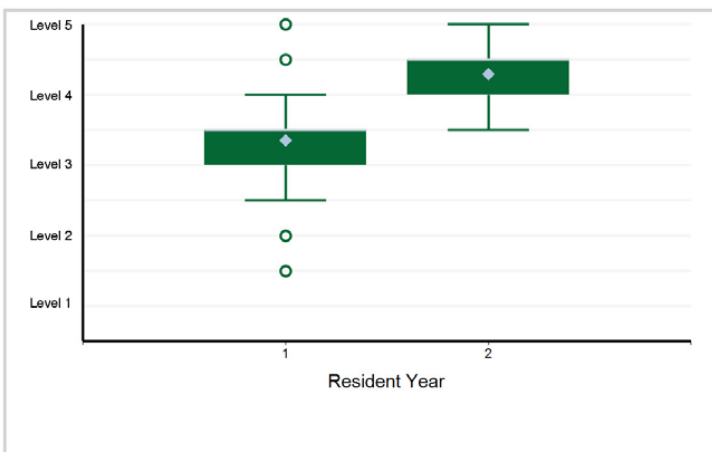

10. Systems-Based Practice - Systems-Based Practice 4: Physician Role in Health Care Systems

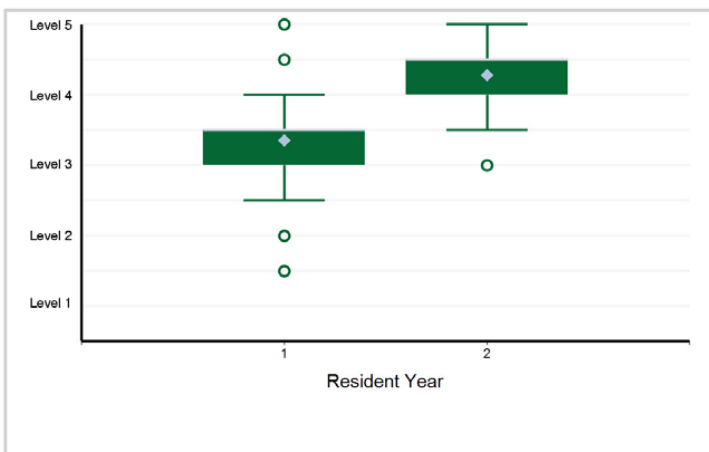

11. Practice-Based Learning and Improvement - Practice-Based Learning and Improvement 1: Evidence-Based and Informed Practice

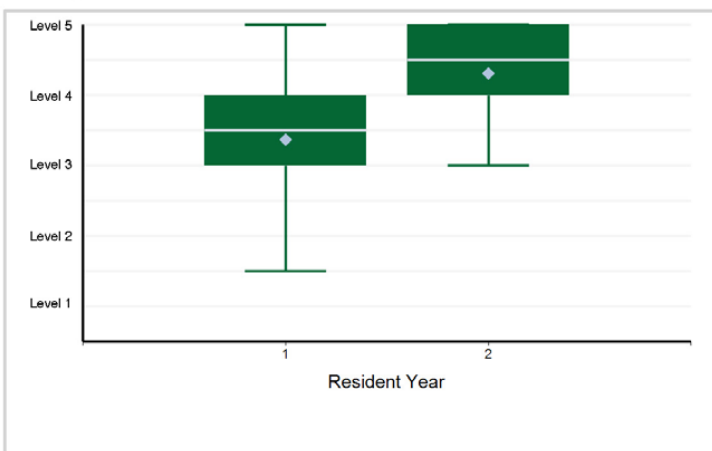

12. Practice-Based Learning and Improvement - Practice-Based Learning and Improvement 2: Reflective Practice and Commitment ...

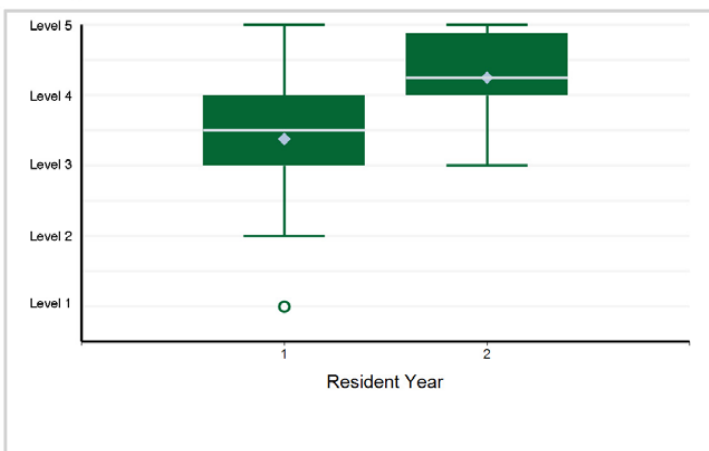

Specialty Box Plot Report - Milestone Evaluation by Resident Year: Year-End 2021-2022

SUBSPECIALTY: Pulmonary Disease

13. Professionalism - Professionalism 1: Professional Behavior and Ethical Principles

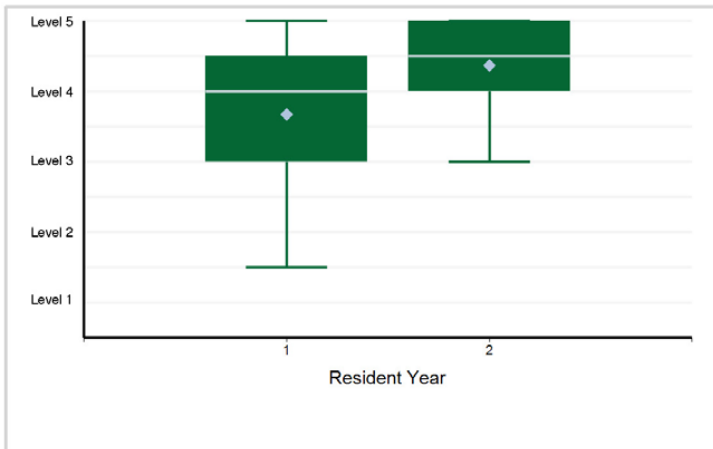

14. Professionalism - Professionalism 2: Accountability

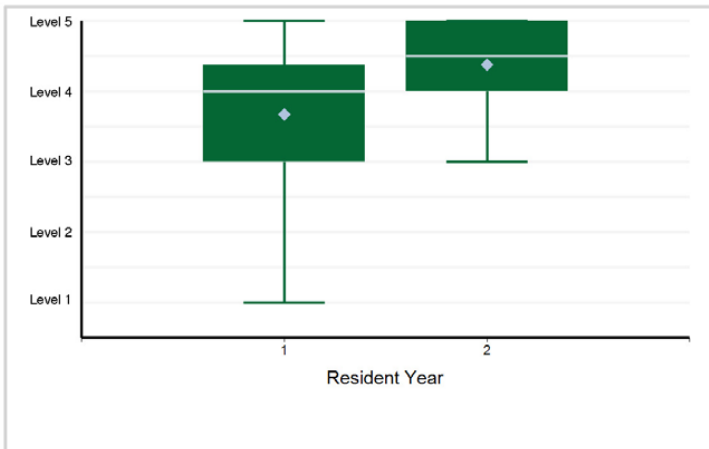

15. Professionalism - Professionalism 3: Well-Being and Resiliency

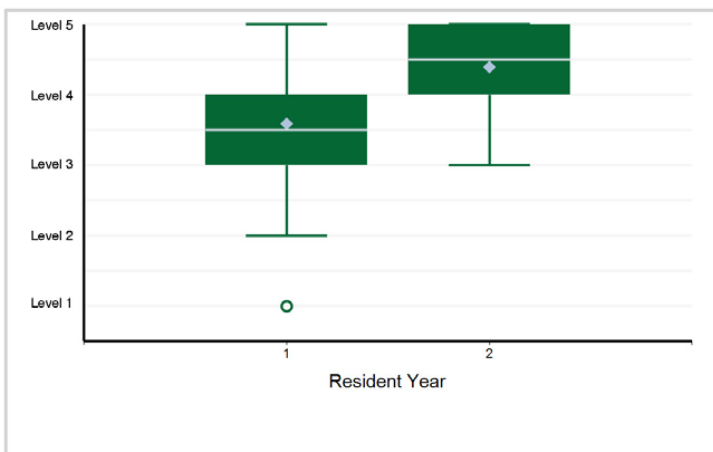

16. Interpersonal and Communication Skills - Interpersonal and Communication Skills 1: Patient- and Family-Centered Communication

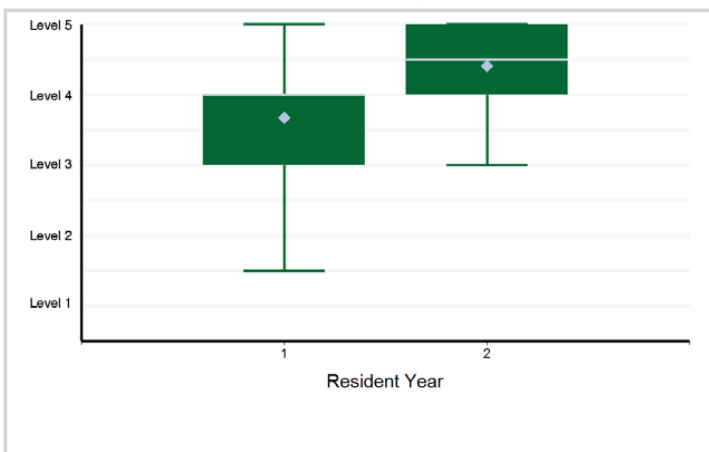

17. Interpersonal and Communication Skills - Interpersonal and Communication Skills 2: Interprofessional and Team Communication

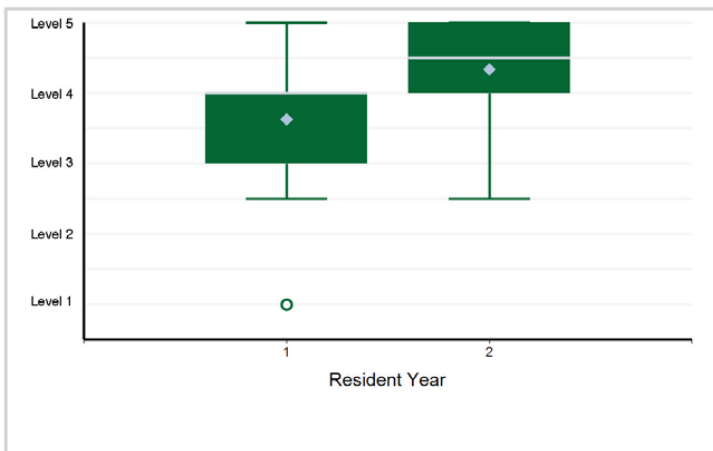

18. Interpersonal and Communication Skills - Interpersonal and Communication Skills 3: Communication within Health Care Systems

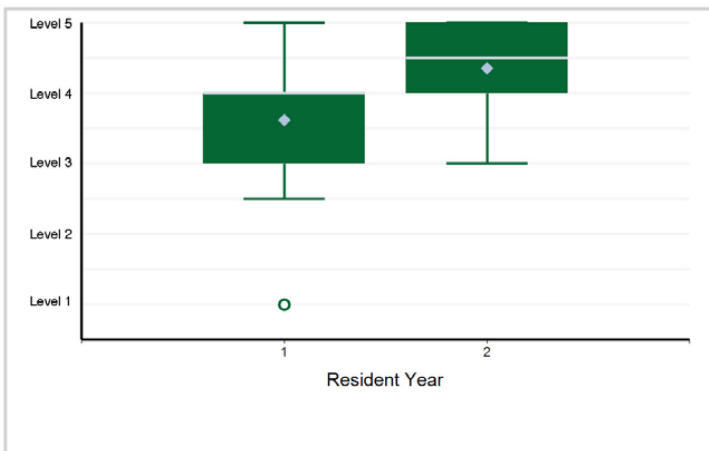

Specialty Box Plot Report - Milestone Evaluation by Resident Year: Year-End 2021-2022

SUBSPECIALTY: **Pulmonary Disease**

19. Interpersonal and Communication Skills - Interpersonal and Communication Skills 4: Complex Communication Around Serious ...

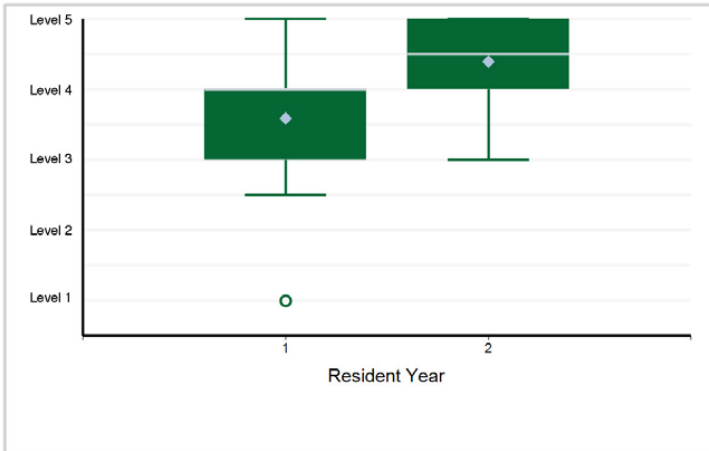

Specialty Box Plot Report - Milestone Evaluation by Resident Year: Year-End 2021-2022

TABLE 45: SUBSPECIALTY: **Pulmonary Disease and Critical Care Medicine**

Resident Year	1	2	3	Total Residents
# of Residents	796	714	667	2,177

1. Patient Care - Patient Care 1: History and Physical Examination

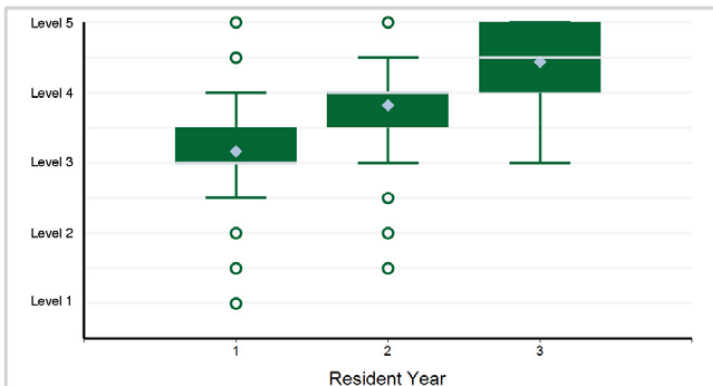

Note: 2 of 2,177 residents have a status of "Not Yet Assessable" and are not included in the analysis.

2. Patient Care - Patient Care 2: Disease Management in Critical Care

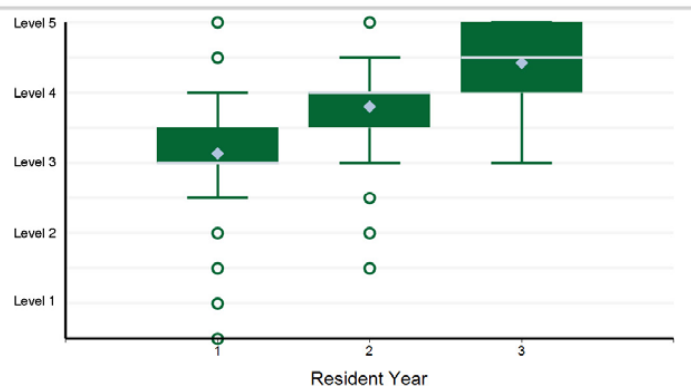

Note: 5 of 2,177 residents have a status of "Not Yet Assessable" and are not included in the analysis.

3. Patient Care - Patient Care 3: Disease Management in Pulmonary Medicine

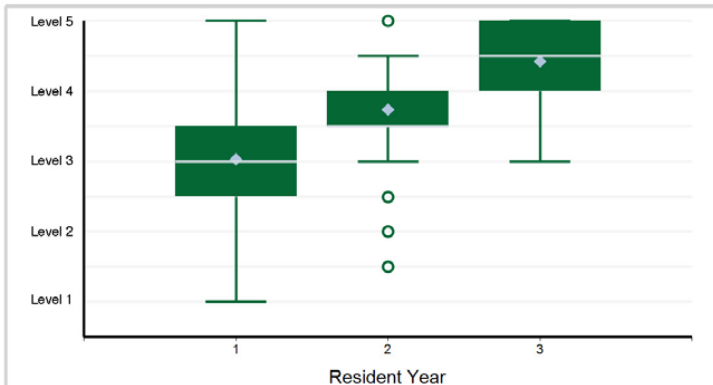

Note: 27 of 2,177 residents have a status of "Not Yet Assessable" and are not included in the analysis.

4. Patient Care - Patient Care 4: Pre-Procedure Assessment

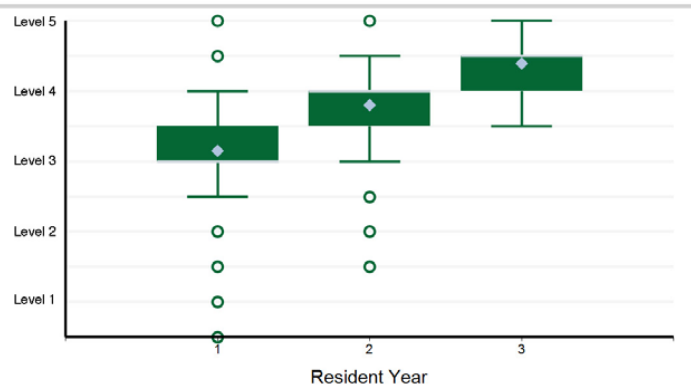

Note: 8 of 2,177 residents have a status of "Not Yet Assessable" and are not included in the analysis.

5. Patient Care - Patient Care 5: Procedures (Invasive and Non-Invasive)

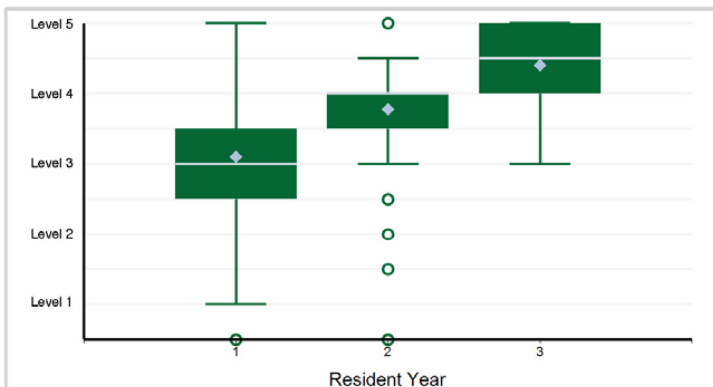

Note: 8 of 2,177 residents have a status of "Not Yet Assessable" and are not included in the analysis.

6. Medical Knowledge - Medical Knowledge 1: Clinical Reasoning

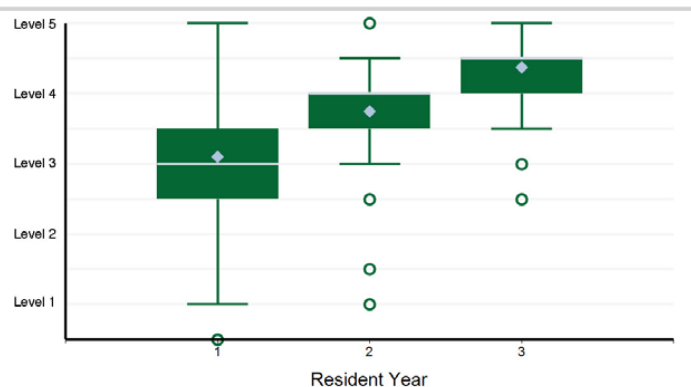

Note: 1 of 2,177 residents have a status of "Not Yet Assessable" and are not included in the analysis.

Specialty Box Plot Report - Milestone Evaluation by Resident Year: Year-End 2021-2022

SUBSPECIALTY: Pulmonary Disease and Critical Care Medicine

7. Medical Knowledge - Medical Knowledge 2: Scientific Knowledge of Disease and Therapeutics

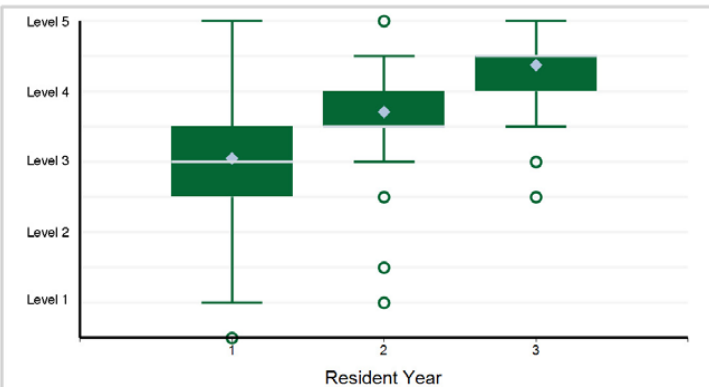

Note: 1 of 2,177 residents have a status of "Not Yet Assessable" and are not included in the analysis.

8. Systems-Based Practice - Systems-Based Practice 1: Patient Safety and Quality Improvement

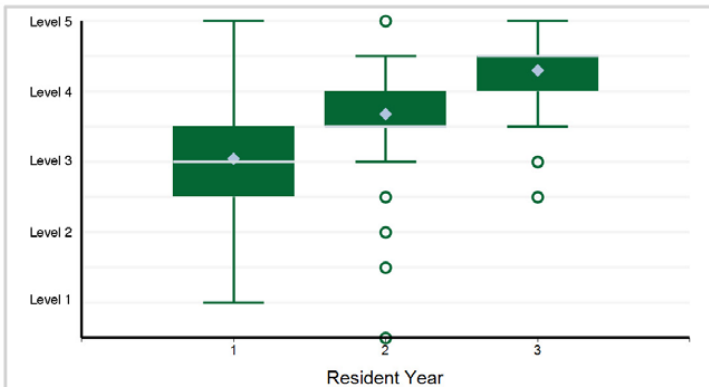

9. Systems-Based Practice - Systems-Based Practice 2: Coordination and Transition of Care

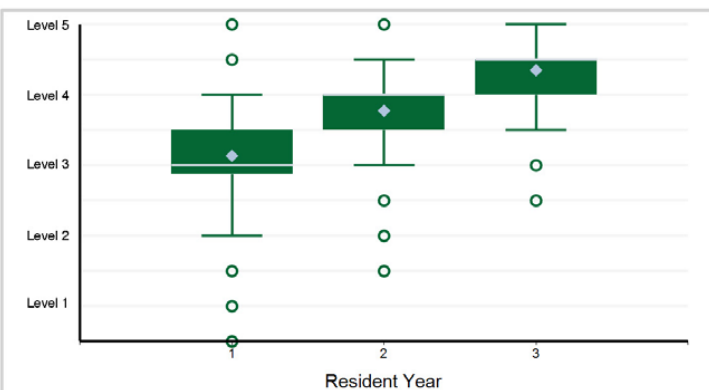

10. Systems-Based Practice - Systems-Based Practice 3: Population Health

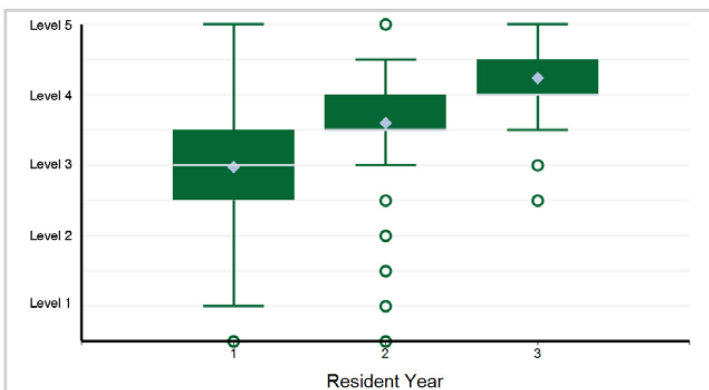

11. Systems-Based Practice - Systems-Based Practice 4: Physician Role in Health Care Systems

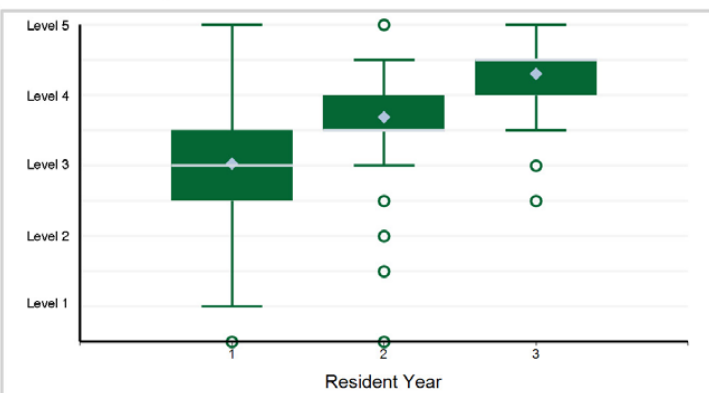

12. Practice-Based Learning and Improvement - Practice-Based Learning and Improvement 1: Evidence-Based and Informed Practice

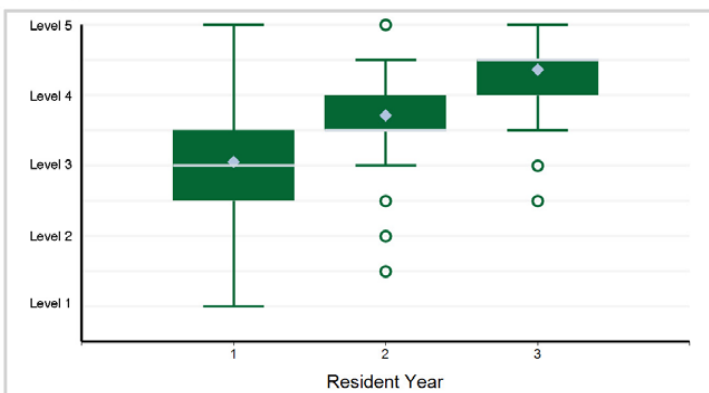

Specialty Box Plot Report - Milestone Evaluation by Resident Year: Year-End 2021-2022

SUBSPECIALTY: Pulmonary Disease and Critical Care Medicine

13. Practice-Based Learning and Improvement - Practice-Based Learning and Improvement 2: Reflective Practice and Commitment ...

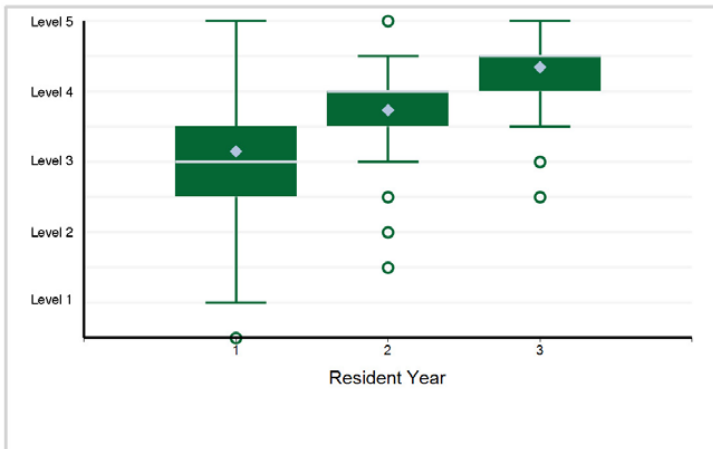

14. Professionalism - Professionalism 1: Professional Behavior and Ethical Principles

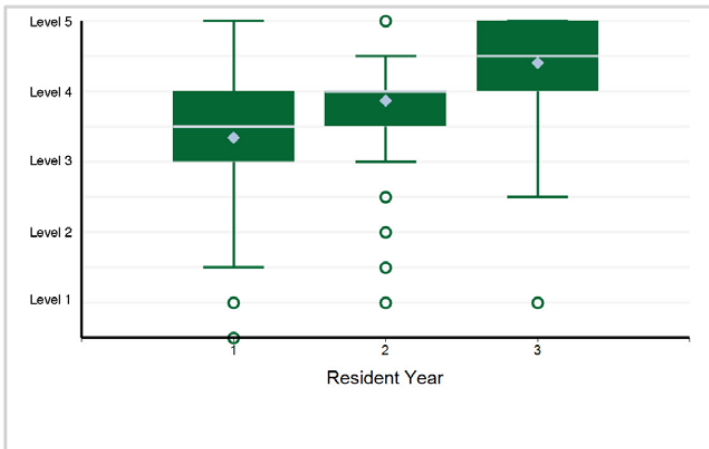

15. Professionalism - Professionalism 2: Accountability

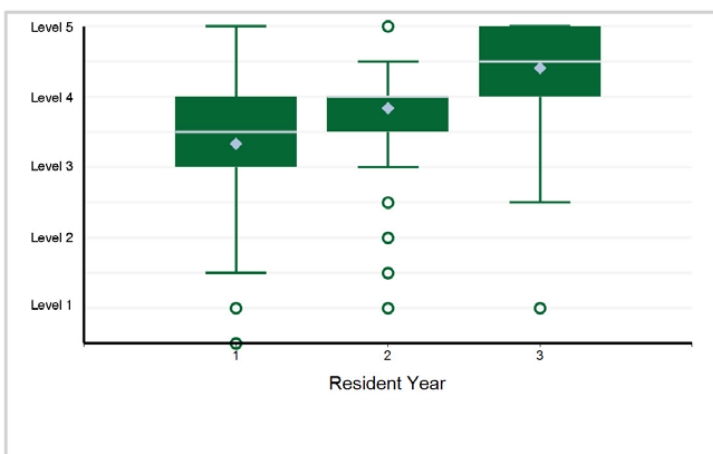

16. Professionalism - Professionalism 3: Well-Being and Resiliency

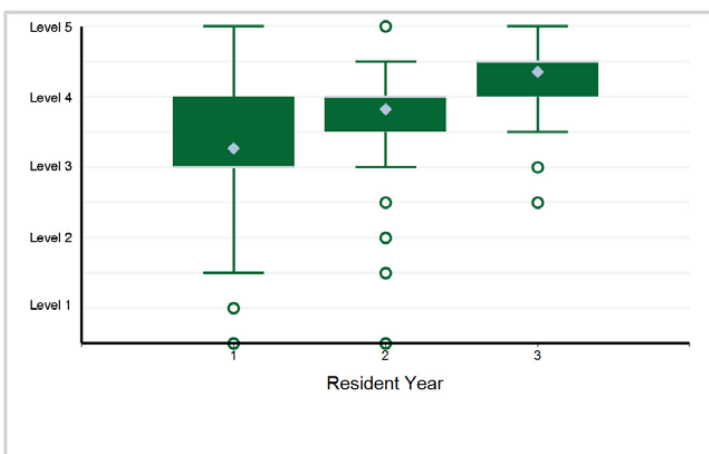

17. Interpersonal and Communication Skills - Interpersonal and Communication Skills 1: Patient- and Family-Centered Communication

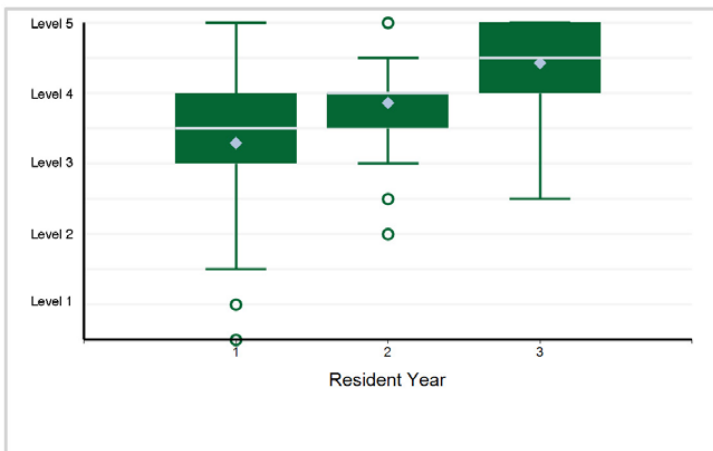

18. Interpersonal and Communication Skills - Interpersonal and Communication Skills 2: Interprofessional and Team Communication

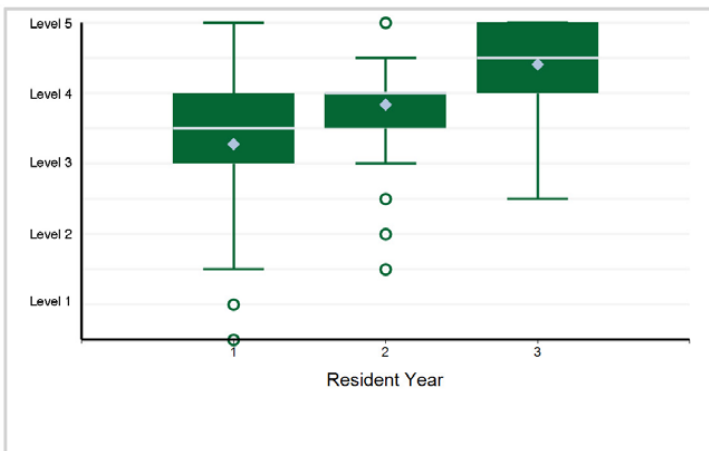

Specialty Box Plot Report - Milestone Evaluation by Resident Year: Year-End 2021-2022

SUBSPECIALTY: Pulmonary Disease and Critical Care Medicine

19. Interpersonal and Communication Skills - Interpersonal and Communication Skills 3: Communication within Health Care Systems

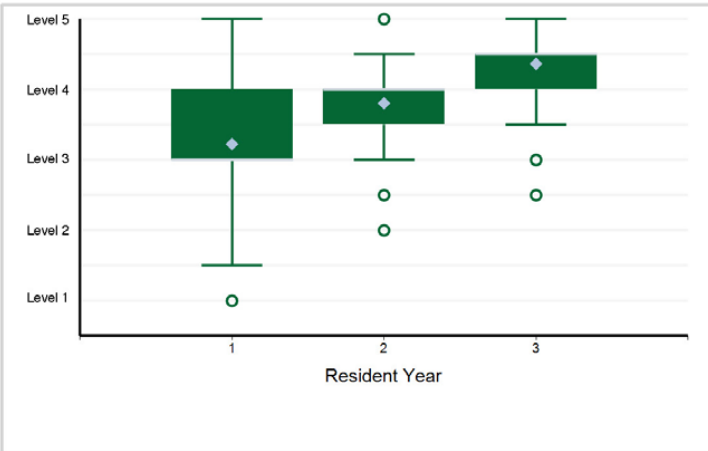

20. Interpersonal and Communication Skills - Interpersonal and Communication Skills 4: Complex Communication Around Serious ...

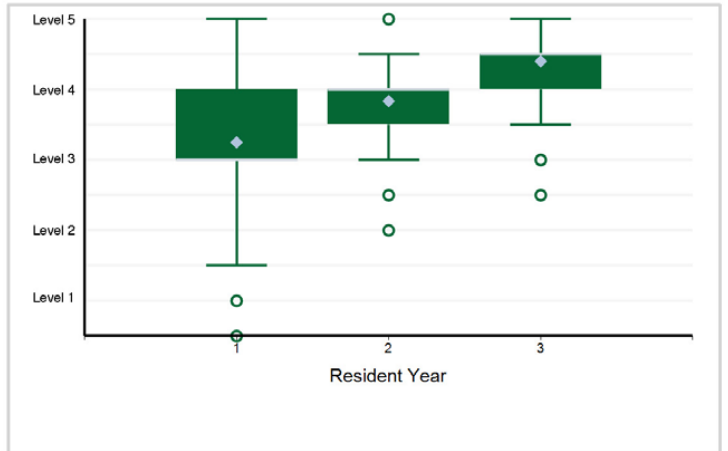

Specialty Box Plot Report - Milestone Evaluation by Resident Year: Year-End 2021-2022

TABLE 46: SUBSPECIALTY: **Rheumatology**

Resident Year	1	2	Total Residents*
# of Residents	269	266	535

*Note: There are 6 residents with an incomplete milestone evaluation that are excluded from the box plots below.

1. Patient Care - Patient Care 1: Gathers an Essential and Accurate Patient History

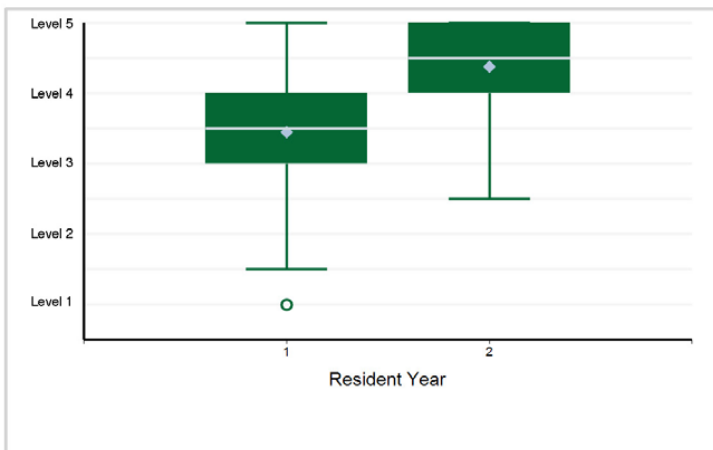

2. Patient Care - Patient Care 2: Physical Examination

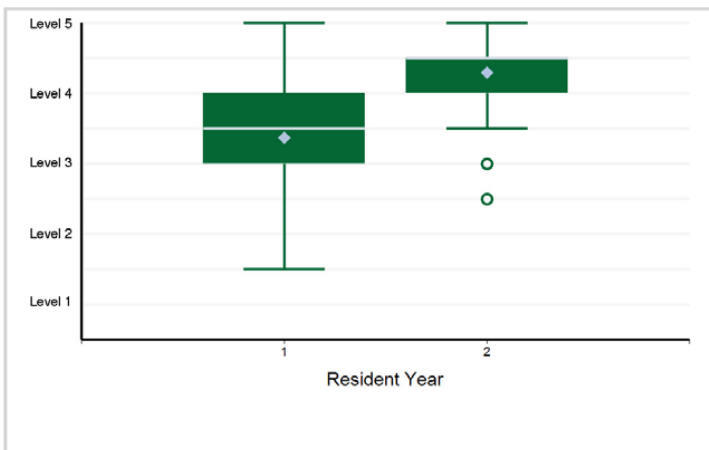

3. Patient Care - Patient Care 3: Comprehensive Management Plan Development

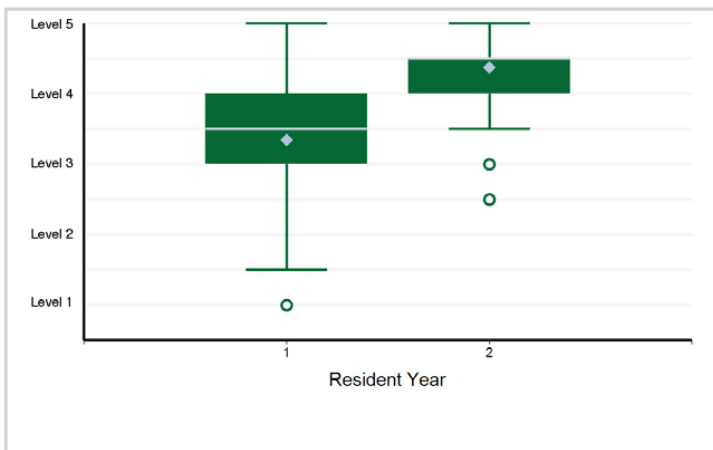

4. Patient Care - Patient Care 4: Therapeutics, including Immunomodulatory Agents

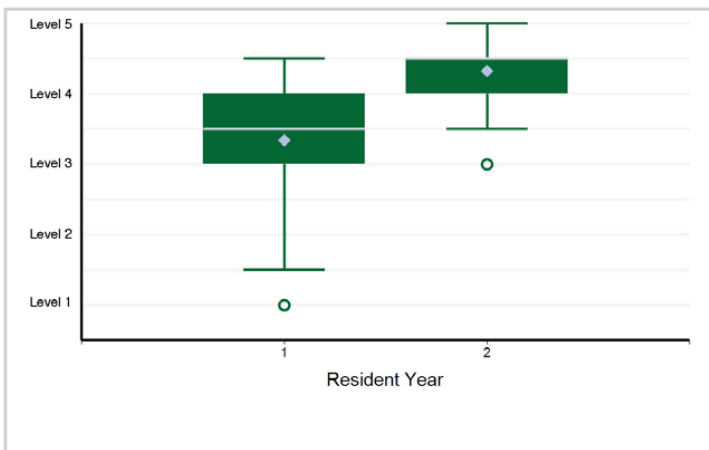

5. Patient Care - Patient Care 5: Procedures

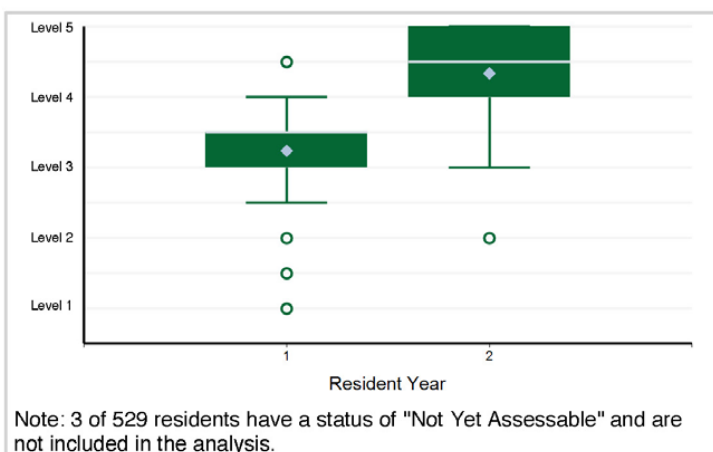

6. Patient Care - Patient Care 6: Provides Consultative Care

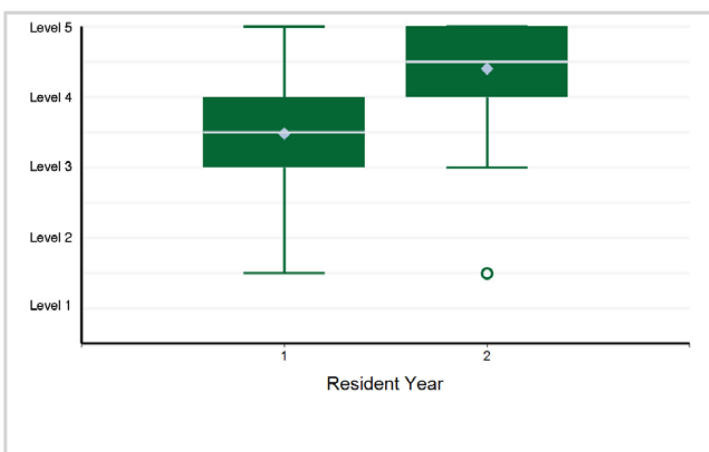

Note: 3 of 529 residents have a status of "Not Yet Assessable" and are not included in the analysis.

Specialty Box Plot Report - Milestone Evaluation by Resident Year: Year-End 2021-2022

SUBSPECIALTY: **Rheumatology**

7. Medical Knowledge - Medical Knowledge 1: Possesses Clinical Knowledge

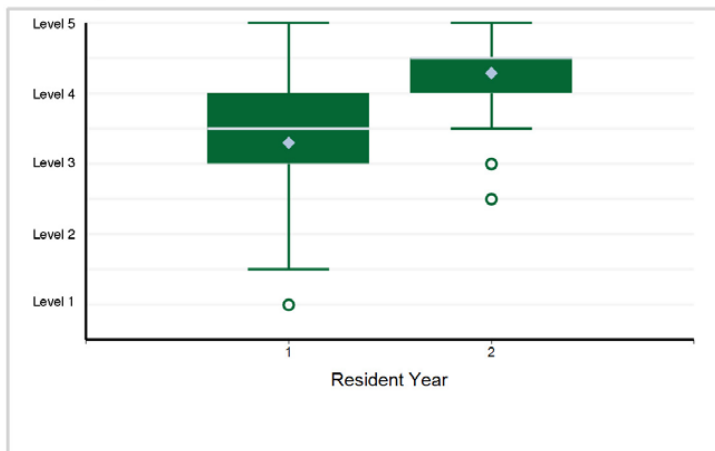

8. Medical Knowledge - Medical Knowledge 2: Knowledge of Diagnostic Testing

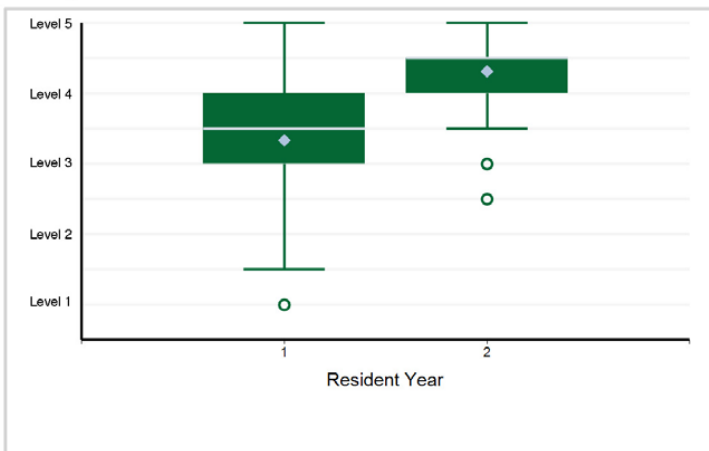

9. Medical Knowledge - Medical Knowledge 3: Scholarly Activity

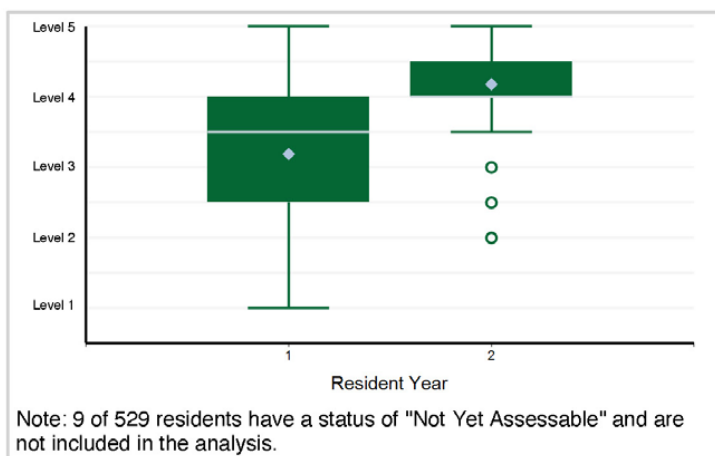

10. Systems-Based Practice - Systems-Based Practice 1: Patient Safety and Quality Improvement

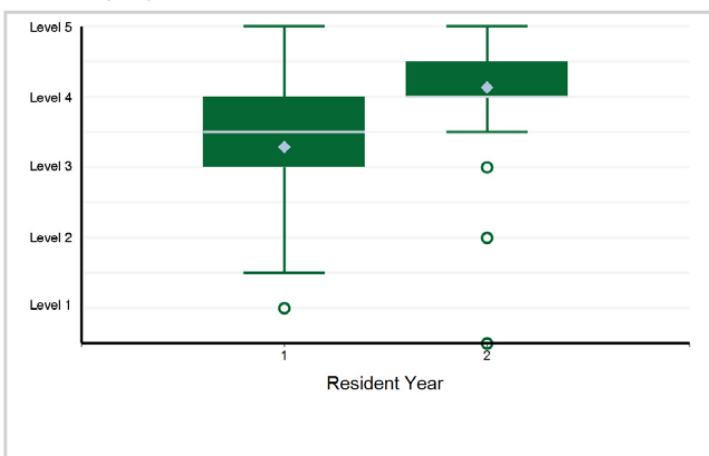

11. Systems-Based Practice - Systems-Based Practice 2: System Navigation for Patient-Centered Care

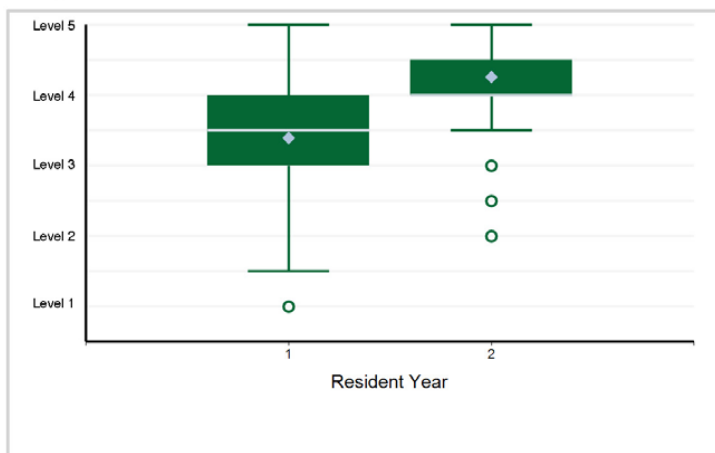

12. Systems-Based Practice - Systems-Based Practice 3: Physician Role in Health Care Systems

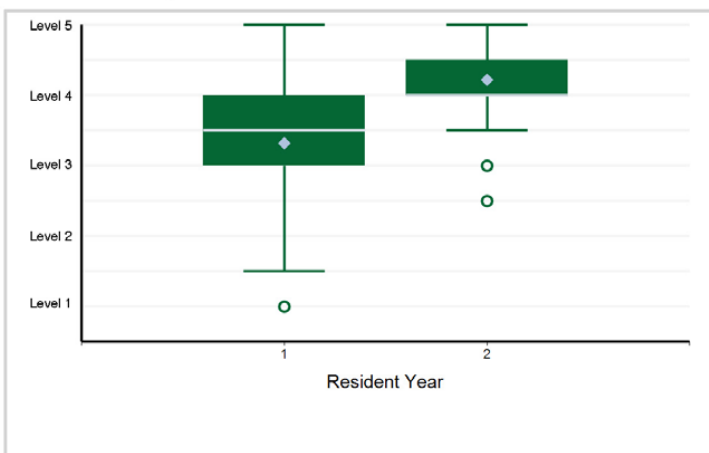

Specialty Box Plot Report - Milestone Evaluation by Resident Year: Year-End 2021-2022

SUBSPECIALTY: Rheumatology

13. Practice-Based Learning and Improvement - Practice-Based Learning and Improvement 1: Evidence-Based and Informed Practice

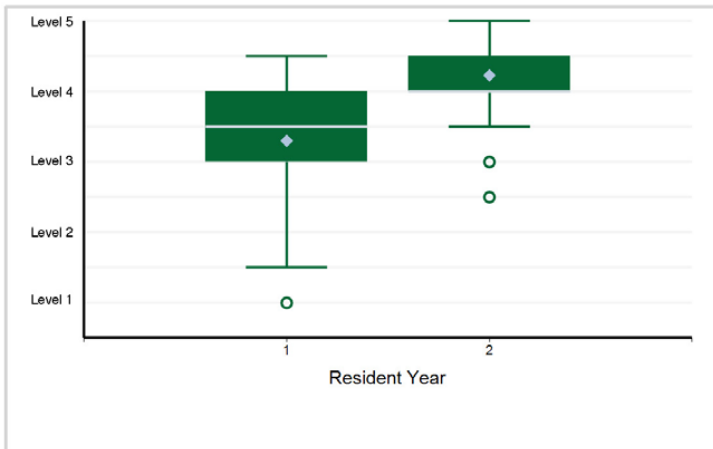

14. Practice-Based Learning and Improvement - Practice-Based Learning and Improvement 2: Commitment to Reflective ...

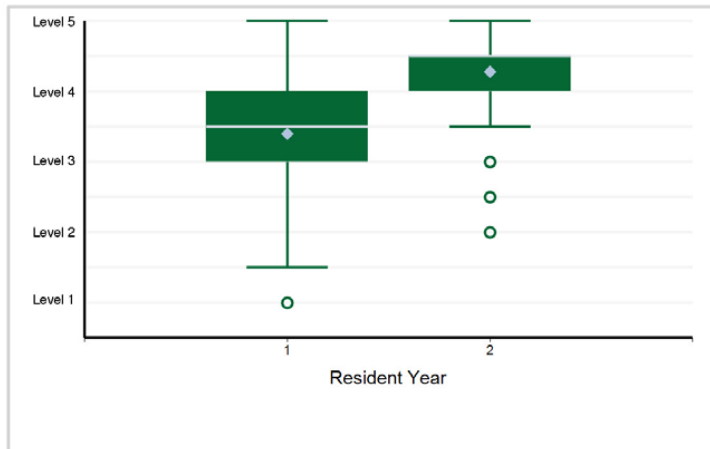

15. Professionalism - Professionalism 1: Professional Behavior

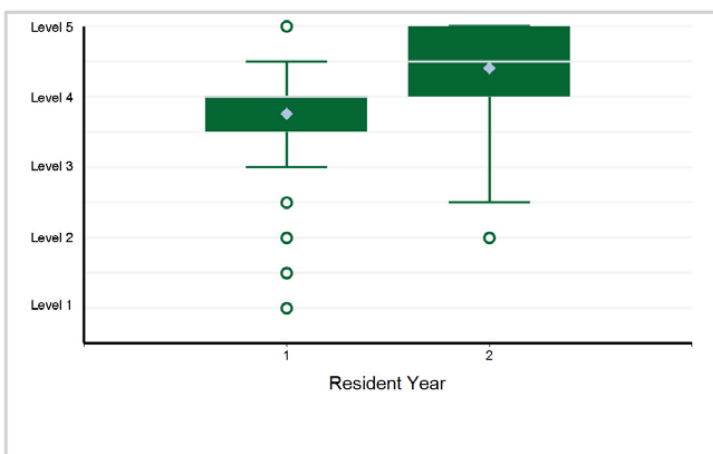

16. Professionalism - Professionalism 2: Ethical Principles

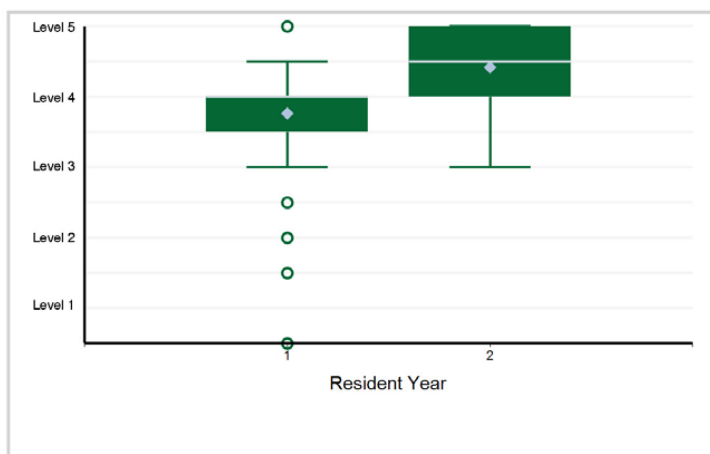

17. Professionalism - Professionalism 3: Accountability/Conscientiousness

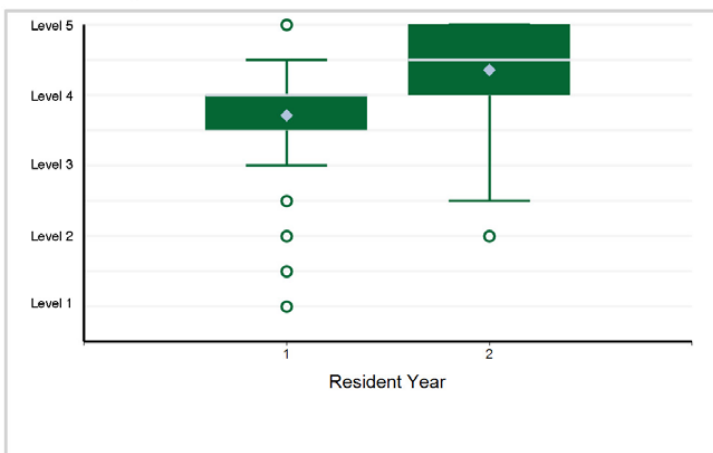

18. Professionalism - Professionalism 4: Self-Awareness and Help-Seeking

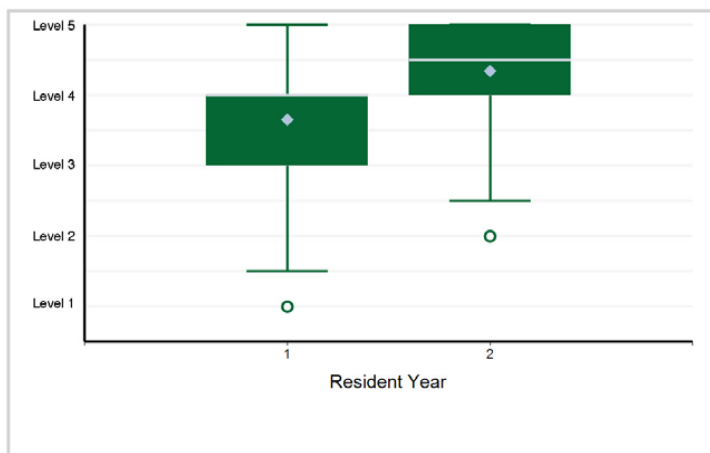

Specialty Box Plot Report - Milestone Evaluation by Resident Year: Year-End 2021-2022

SUBSPECIALTY: Rheumatology

19. Interpersonal and Communication Skills - Interpersonal and Communication Skills 1: Patient- and Family-Centered Communication

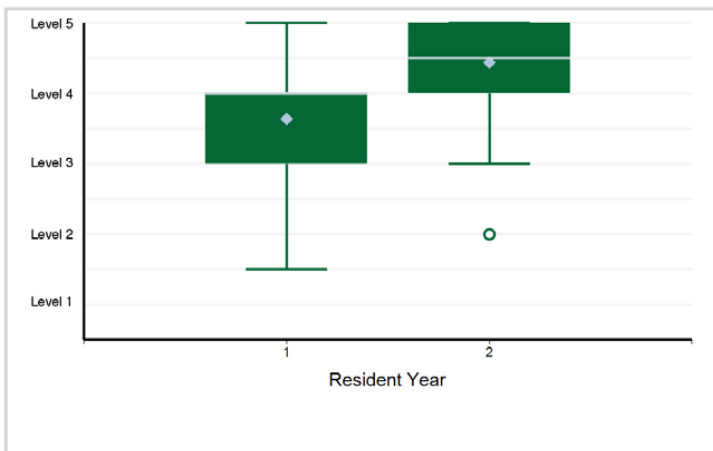

20. Interpersonal and Communication Skills - Interpersonal and Communication Skills 2: Interprofessional and Team Communication

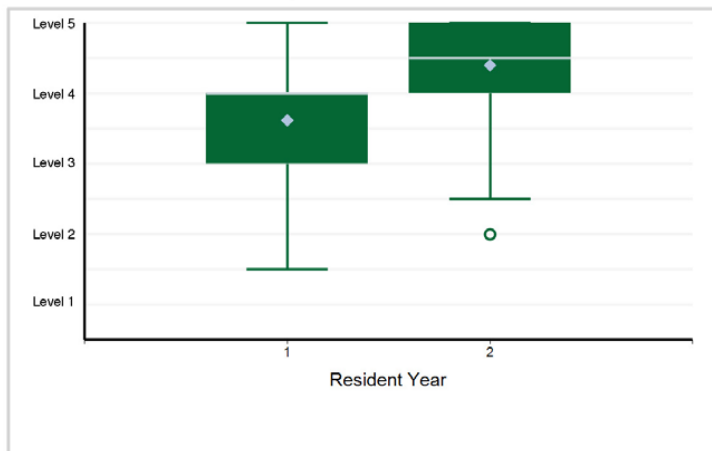

21. Interpersonal and Communication Skills - Interpersonal and Communication Skills 3: Patient-Centered ...

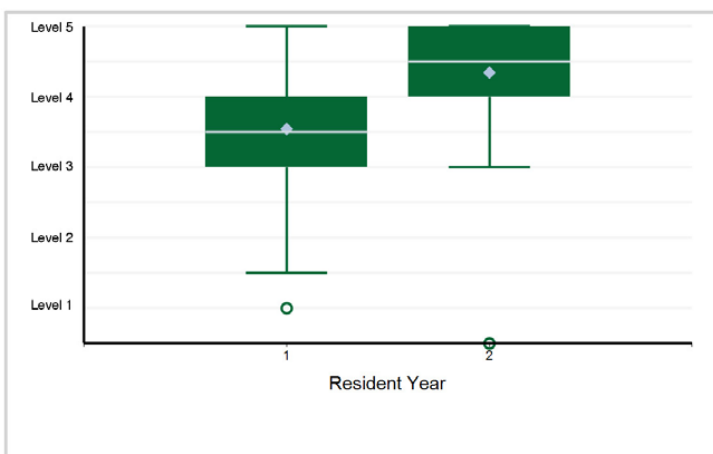

Specialty Box Plot Report - Milestone Evaluation by Resident Year: Year-End 2021-2022

TABLE 47: SUBSPECIALTY: **Sleep Medicine (multidisciplinary, Internal Medicine)**

Resident Year	1	Total Residents
# of Residents	205	205

1. Patient Care - Patient Care 1: Gather and Synthesize Information from Sleep Medicine Patients Across the Lifespan

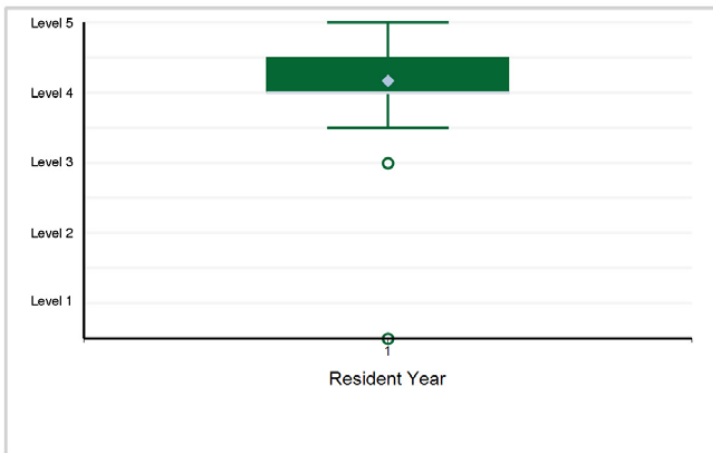

2. Patient Care - Patient Care 2: Use of Diagnostic Tools in Sleep Medicine Across the Lifespan

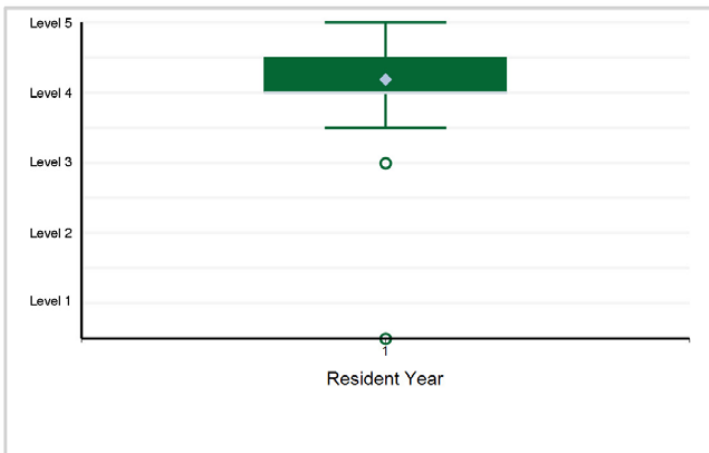

3. Patient Care - Patient Care 3: Interpretation of Physiologic Testing in Sleep Medicine Across the Lifespan

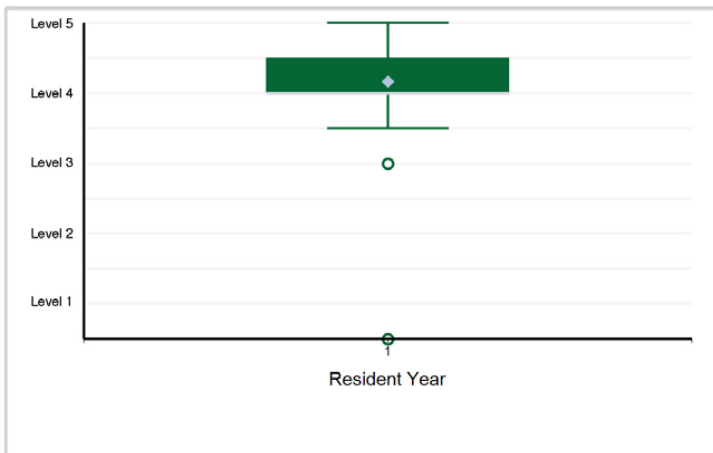

4. Patient Care - Patient Care 4: Management Plan for Sleep Medicine Patients Across the Lifespan

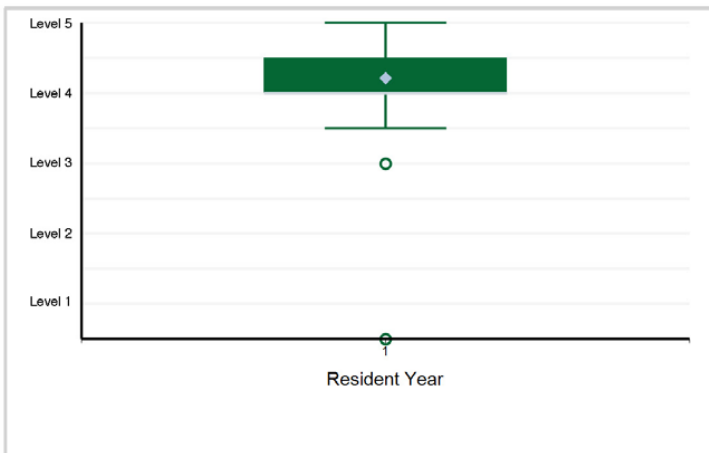

5. Medical Knowledge - Medical Knowledge 1: Sleep Medicine Clinical Science

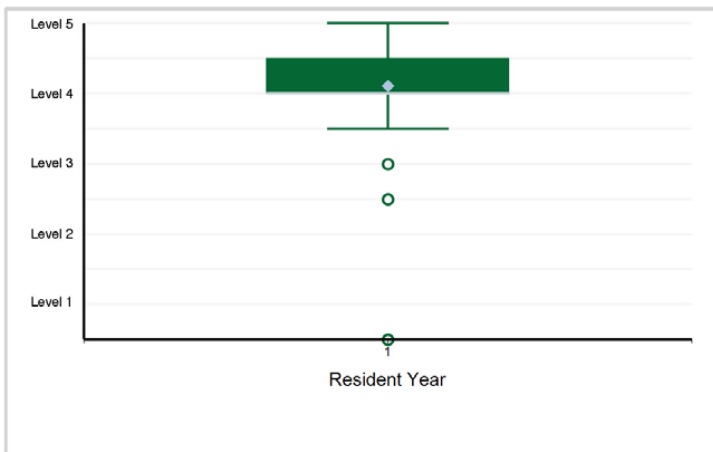

6. Medical Knowledge - Medical Knowledge 2: Therapeutic Knowledge for Sleep Disorders

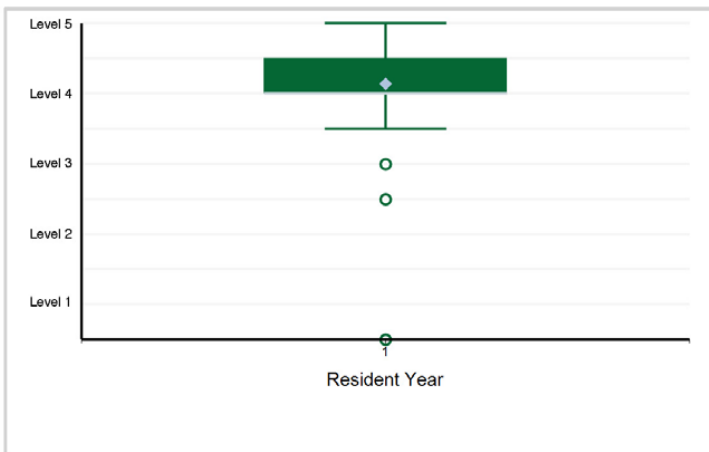

Specialty Box Plot Report - Milestone Evaluation by Resident Year: Year-End 2021-2022

SUBSPECIALTY: Sleep Medicine (multidisciplinary, Internal Medicine)

7. Systems-Based Practice - Systems-Based Practice 1: Patient Safety and Quality Improvement

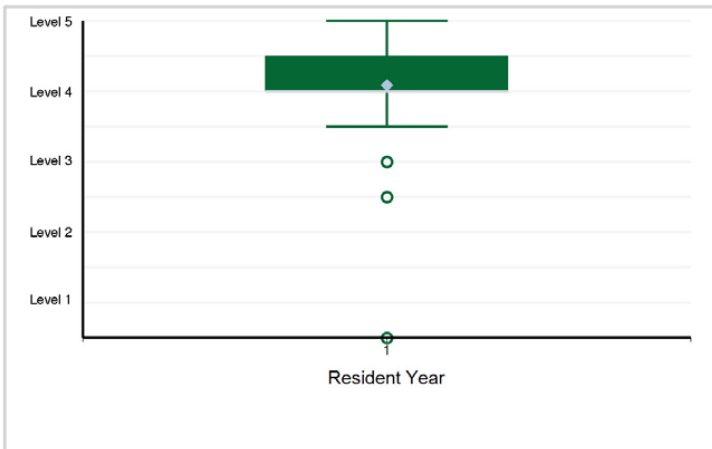

8. Systems-Based Practice - Systems-Based Practice 2: System Navigation for Patient-Centered Care

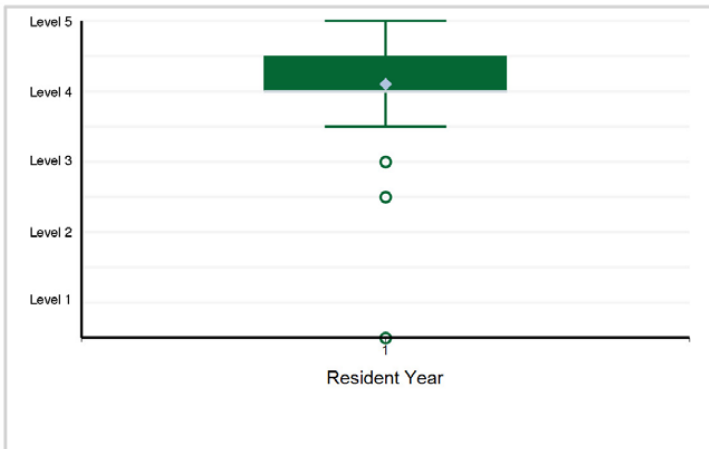

9. Systems-Based Practice - Systems-Based Practice 3: Physician Role in Health Care Systems

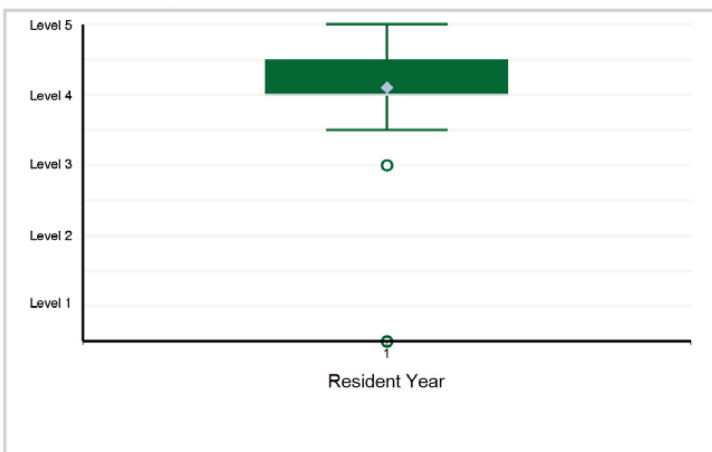

10. Practice-Based Learning and Improvement - Practice-Based Learning and Improvement 1: Evidence-Based and Informed Practice

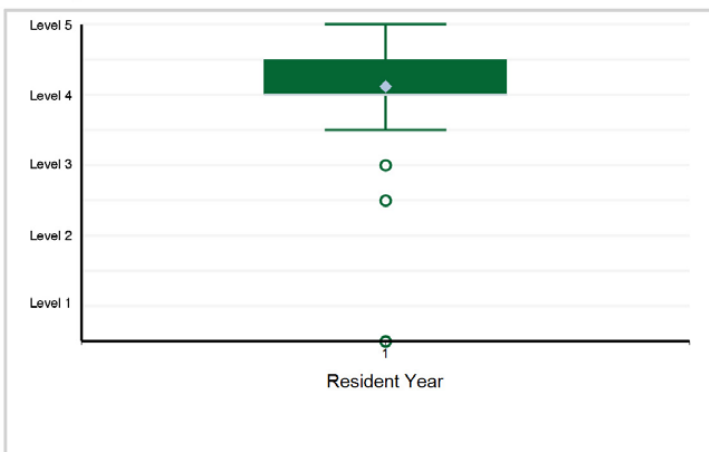

11. Practice-Based Learning and Improvement - Practice-Based Learning and Improvement 2: Reflective Practice and Commitment ...

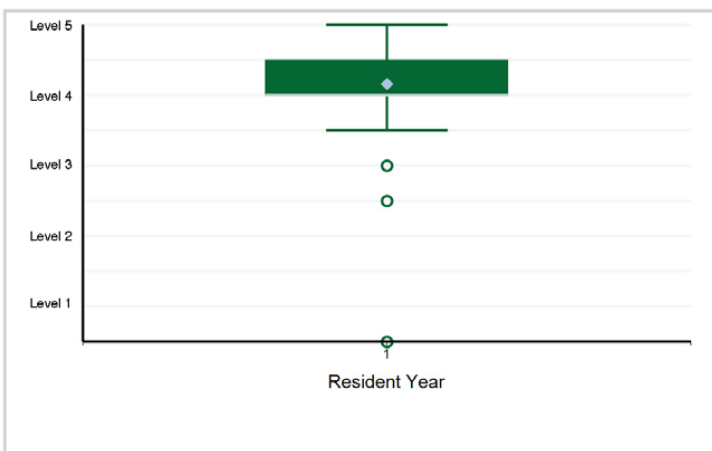

12. Professionalism - Professionalism 1: Professional Behavior and Ethical Principles

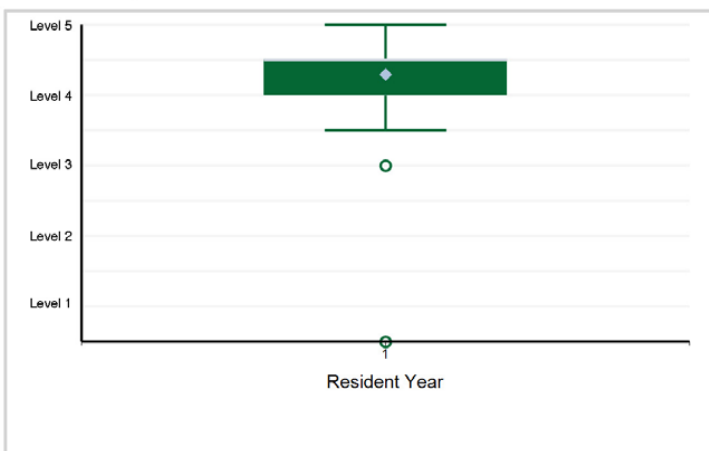

Specialty Box Plot Report - Milestone Evaluation by Resident Year: Year-End 2021-2022

SUBSPECIALTY: Sleep Medicine (multidisciplinary, Internal Medicine)

13. Professionalism - Professionalism 2: Accountability/Conscientiousness

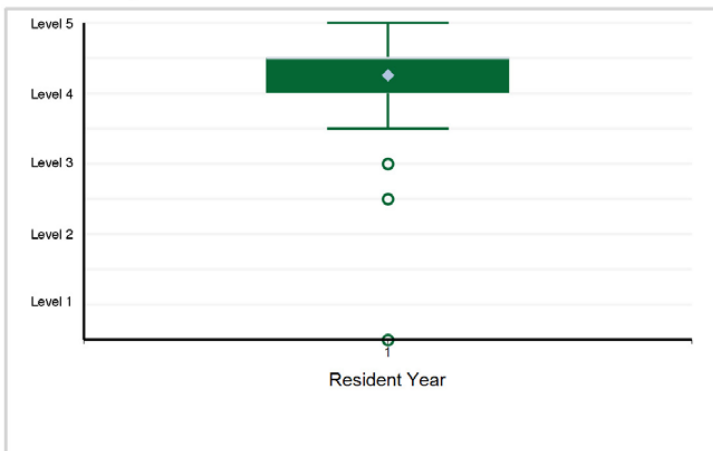

14. Professionalism - Professionalism 3: Self-Awareness and Help-Seeking

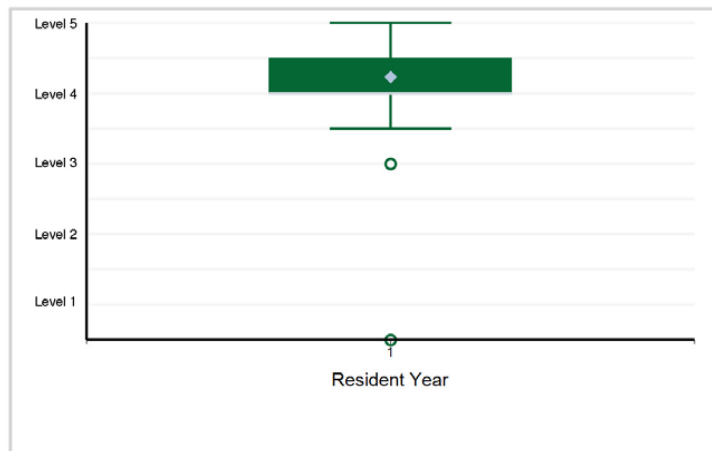

15. Interpersonal and Communication Skills - Interpersonal and Communication Skills 1: Patient- and Family-Centered Communication

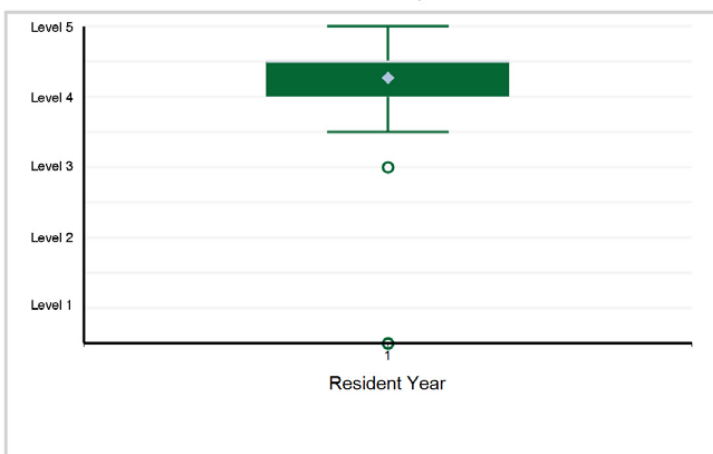

16. Interpersonal and Communication Skills - Interpersonal and Communication Skills 2: Barrier and Bias Mitigation

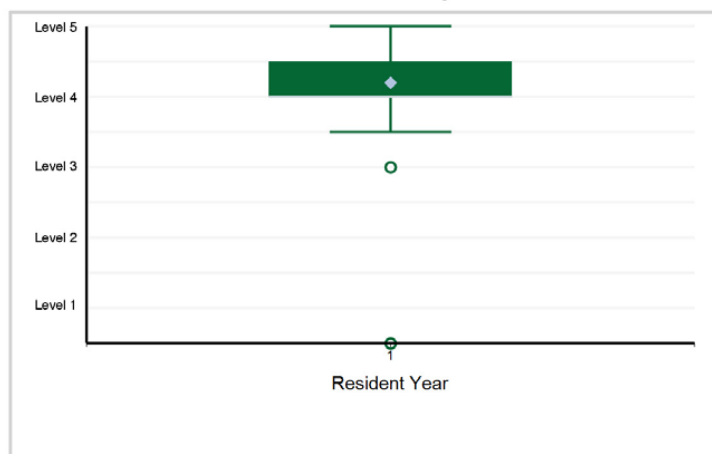

17. Interpersonal and Communication Skills - Interpersonal and Communication Skills 3: Interprofessional and Team Communication

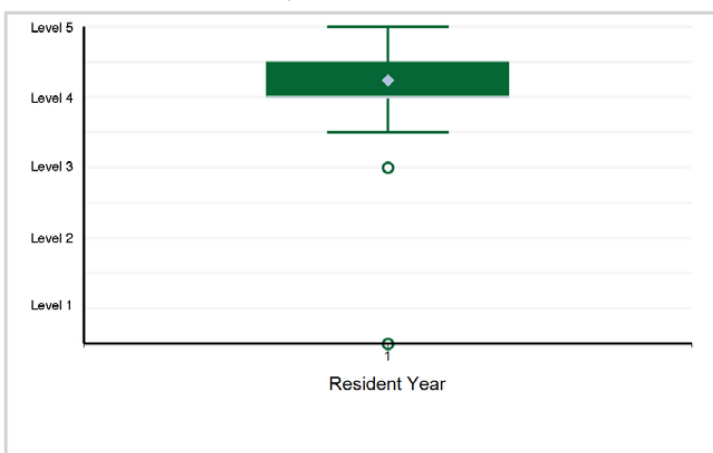

18. Interpersonal and Communication Skills - Interpersonal and Communication Skills 4: Communication within Health Care Systems

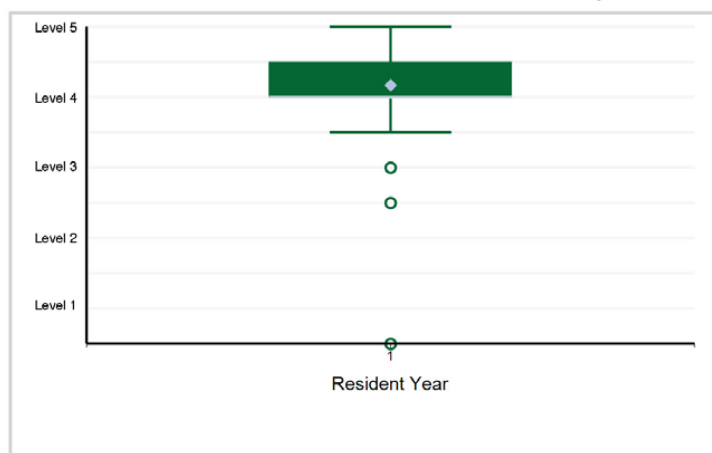

Specialty Box Plot Report - Milestone Evaluation by Resident Year: Year-End 2021-2022

TABLE 48: SUBSPECIALTY: **Transplant Hepatology**

Resident Year	1	Total Residents
# of Residents	48	48

1. Patient Care - Patient Care 1: Data Gathering and Non-Procedural Diagnostic Testing

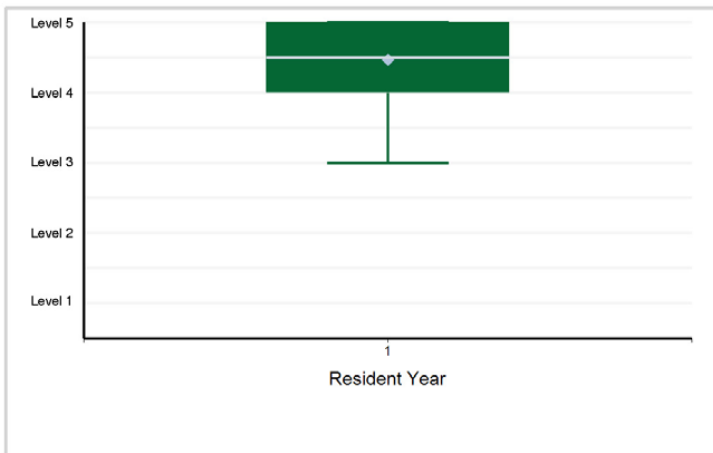

2. Patient Care - Patient Care 2: Patient Management in Gastrointestinal and Liver Disease

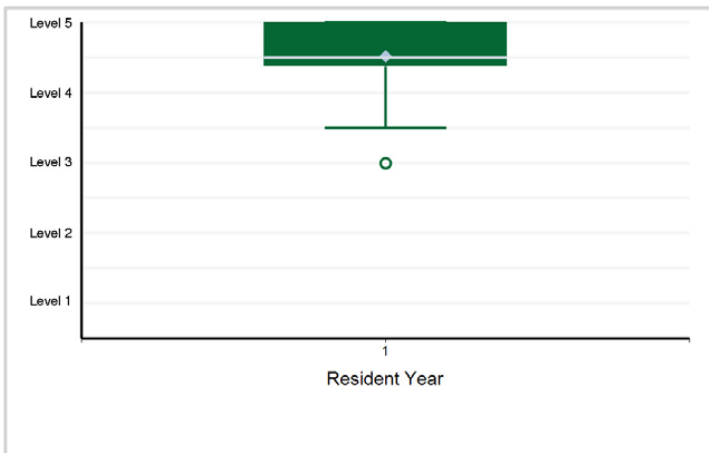

3. Patient Care - Patient Care 3: Technical Procedures – Liver Biopsy

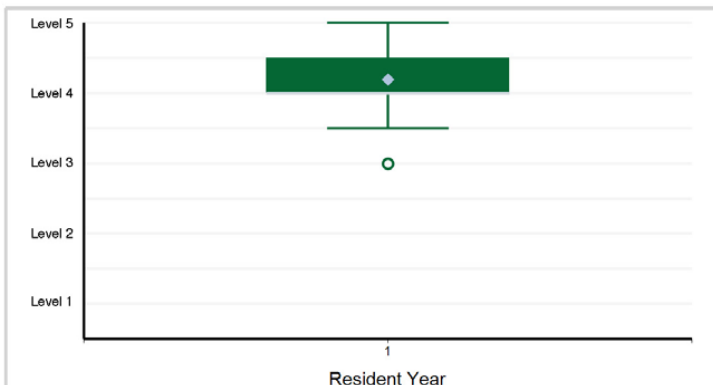

4. Medical Knowledge - Medical Knowledge 1: Clinical Knowledge of Gastrointestinal and Liver Diseases (Non-Procedural)

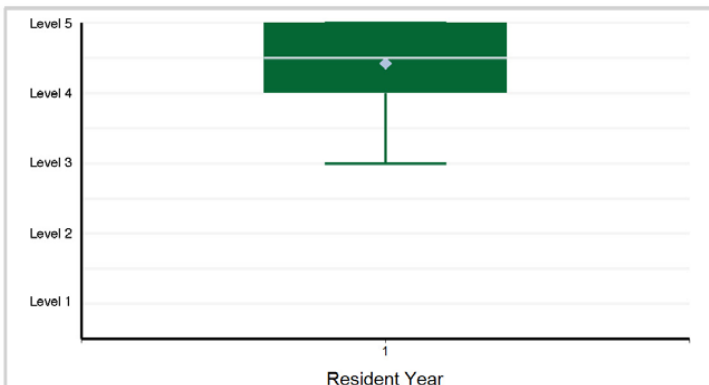

Note: 2 of 48 residents have a status of "Not Yet Assessable" and are not included in the analysis.

5. Medical Knowledge - Medical Knowledge 2: Clinical Reasoning

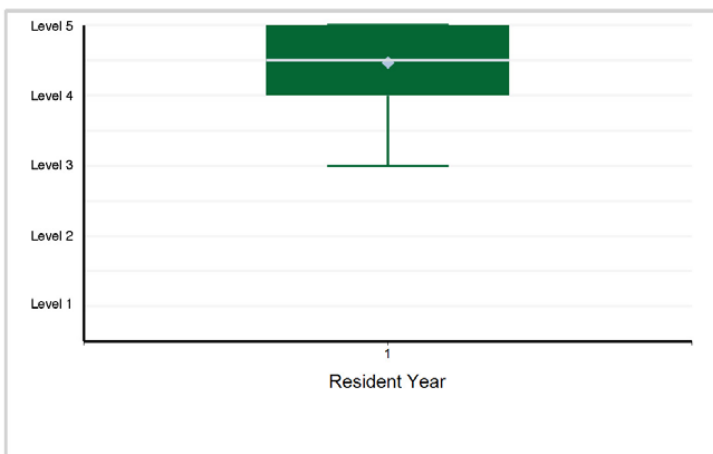

6. Systems-Based Practice - Systems-Based Practice 1: Patient Safety and Quality Improvement



Specialty Box Plot Report - Milestone Evaluation by Resident Year: Year-End 2021-2022

SUBSPECIALTY: Transplant Hepatology

7. Systems-Based Practice - Systems-Based Practice 2: System Navigation for Patient-Centered Care

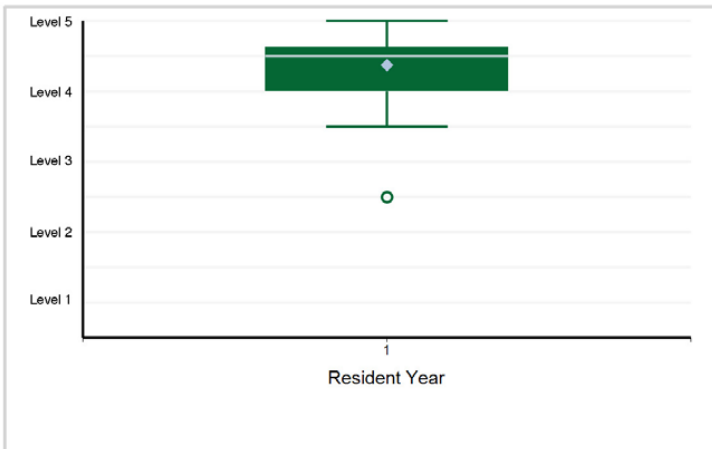

8. Systems-Based Practice - Systems-Based Practice 3: Physician Role in Health Care Systems

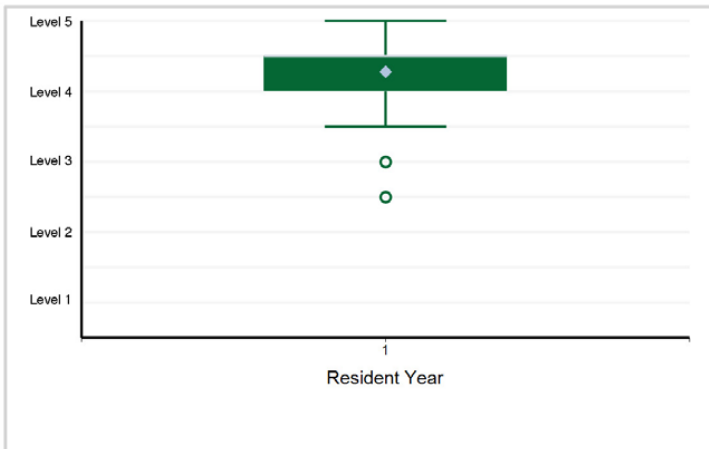

9. Practice-Based Learning and Improvement - Practice-Based Learning and Improvement 1: Evidence-Based and Informed Practice

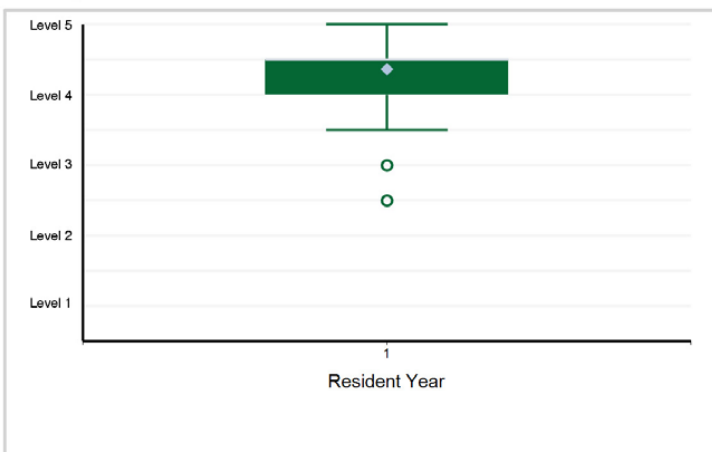

10. Practice-Based Learning and Improvement - Practice-Based Learning and Improvement 2: Reflective Practice and Commitment ...

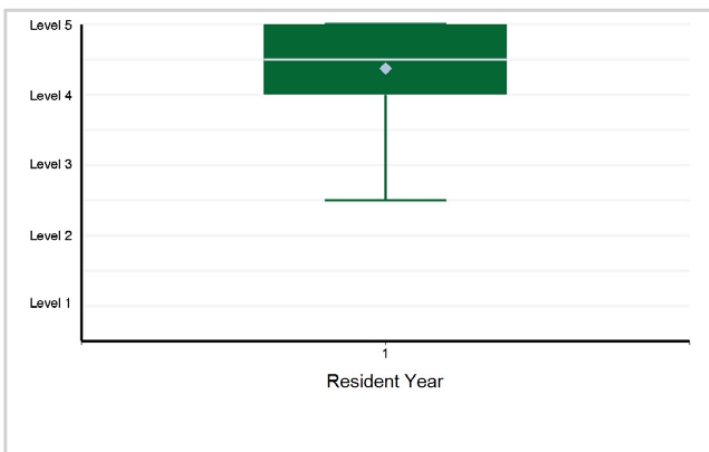

11. Professionalism - Professionalism 1: Professional Behavior and Ethical Principles

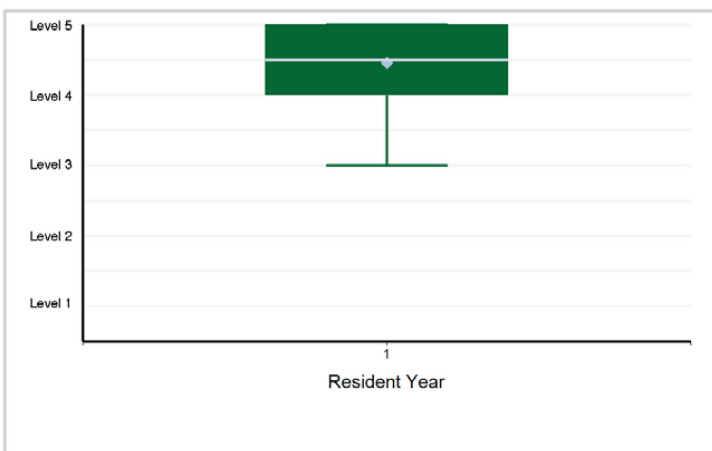

12. Professionalism - Professionalism 2: Accountability/Conscientiousness

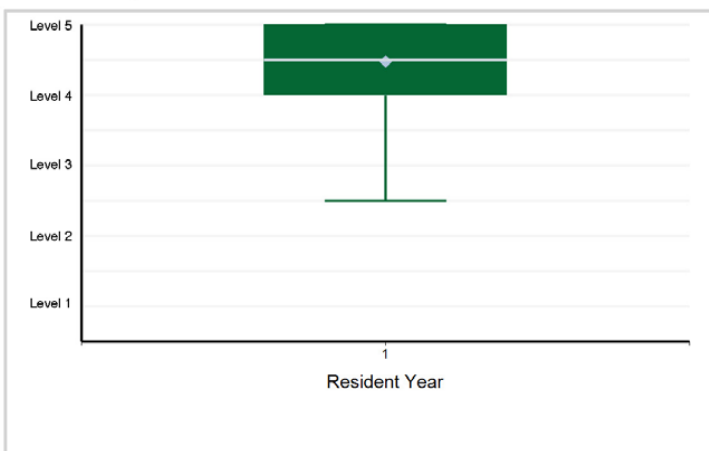

Specialty Box Plot Report - Milestone Evaluation by Resident Year: Year-End 2021-2022

SUBSPECIALTY: Transplant Hepatology

13. Professionalism - Professionalism 3: Self-Awareness and Help-Seeking

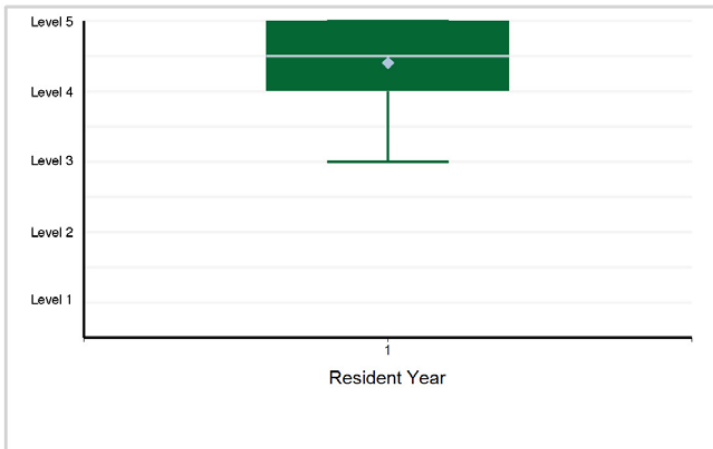

14. Interpersonal and Communication Skills - Interpersonal and Communication Skills 1: Patient- and Family-Centered Communication

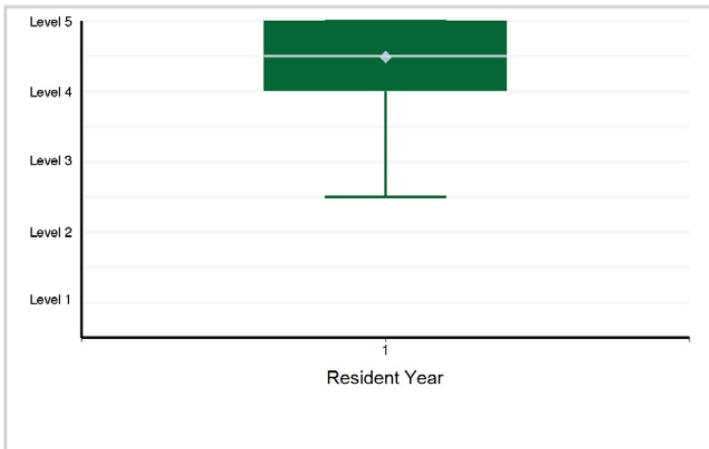

15. Interpersonal and Communication Skills - Interpersonal and Communication Skills 2: Interprofessional and Team Communication

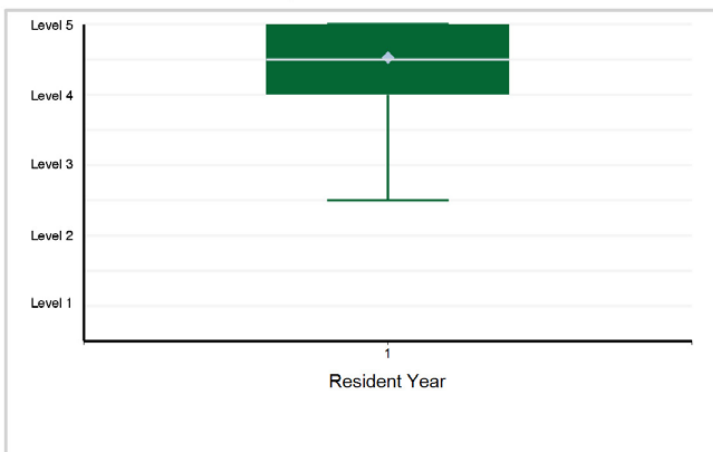

16. Interpersonal and Communication Skills - Interpersonal and Communication Skills 3: Communication within Health Care Systems

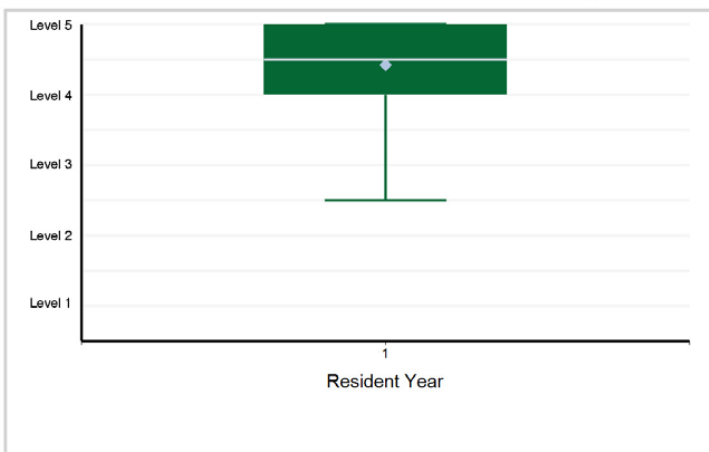

Specialty Box Plot Report - Milestone Evaluation by Resident Year: Year-End 2021-2022

TABLE 49: SPECIALTY: **Medical Genetics and Genomics**

Resident Year	1	2	Total Residents
# of Residents	41	32	73

1. Patient Care - Patient Care 1: History and Physical Examination

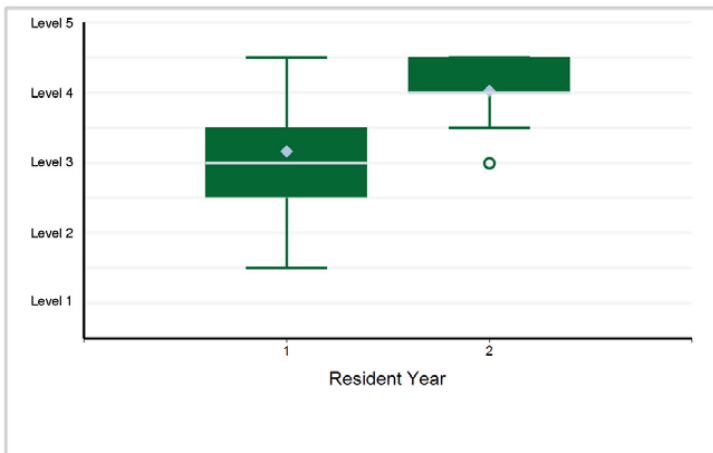

2. Patient Care - Patient Care 2: Selecting Tests, Interpreting Results, and Management of Genetic Conditions

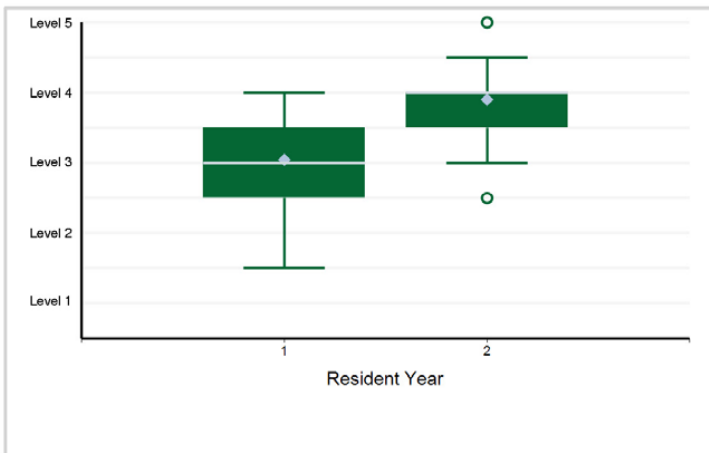

3. Patient Care - Patient Care 3: Pre- and Post-Test Genetic Counseling

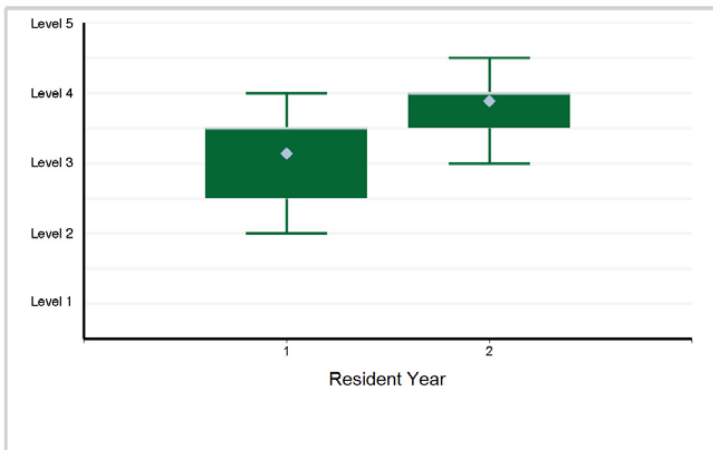

4. Medical Knowledge - Medical Knowledge 1: Foundations of Genetics and Genomics

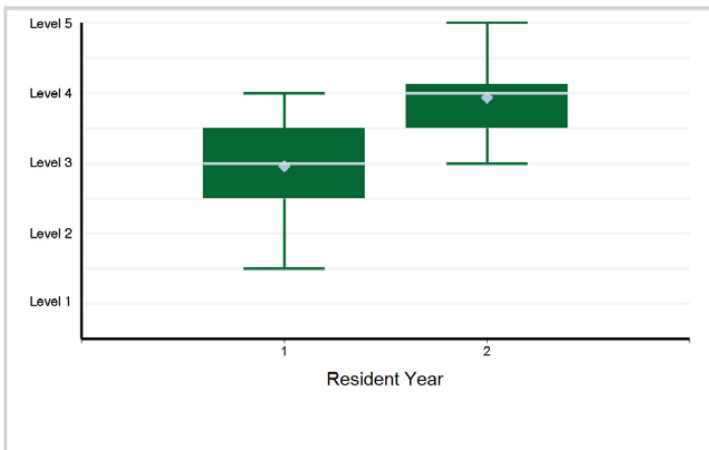

5. Medical Knowledge - Medical Knowledge 2: Clinical Genetics and Genomics

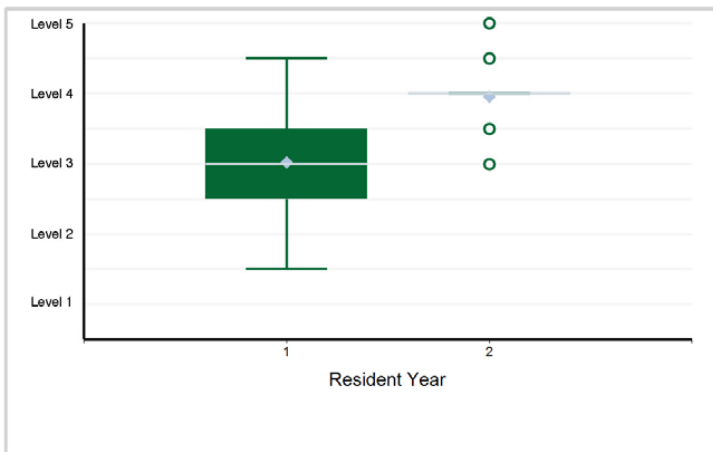

6. Medical Knowledge - Medical Knowledge 3: Clinical Reasoning

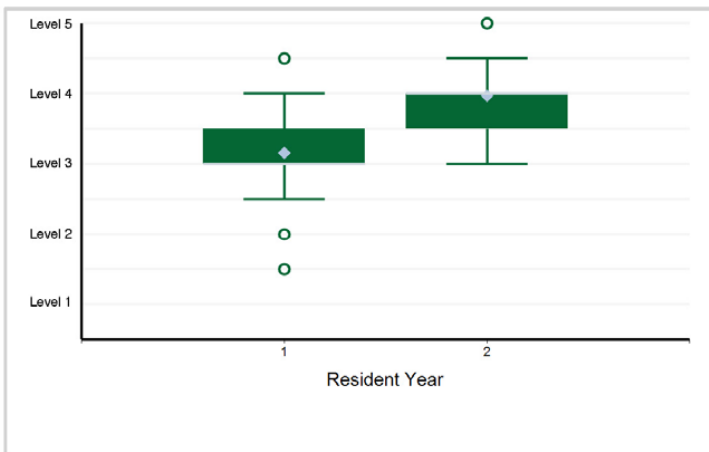

Specialty Box Plot Report - Milestone Evaluation by Resident Year: Year-End 2021-2022

SPECIALTY: Medical Genetics and Genomics

7. Systems-Based Practice - Systems-Based Practice 1: Patient Safety and Quality Improvement

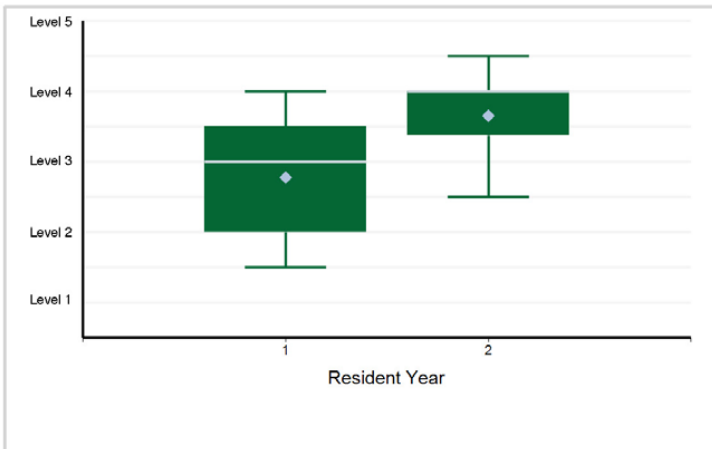

8. Systems-Based Practice - Systems-Based Practice 2: System Navigation for Patient-Centered Care

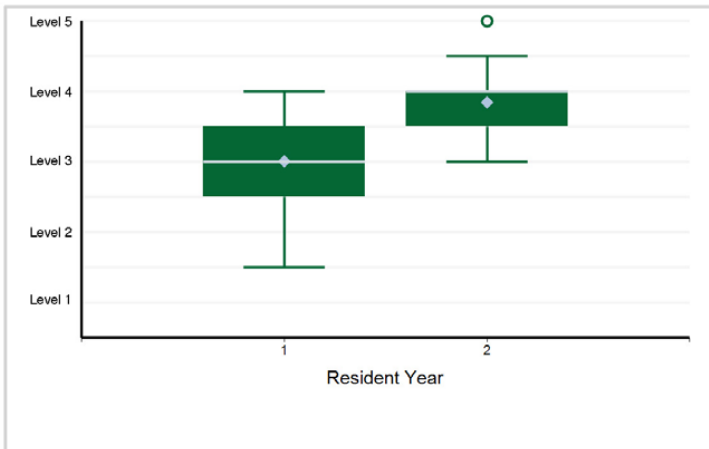

9. Systems-Based Practice - Systems-Based Practice 3: Physician Role in Health Care Systems

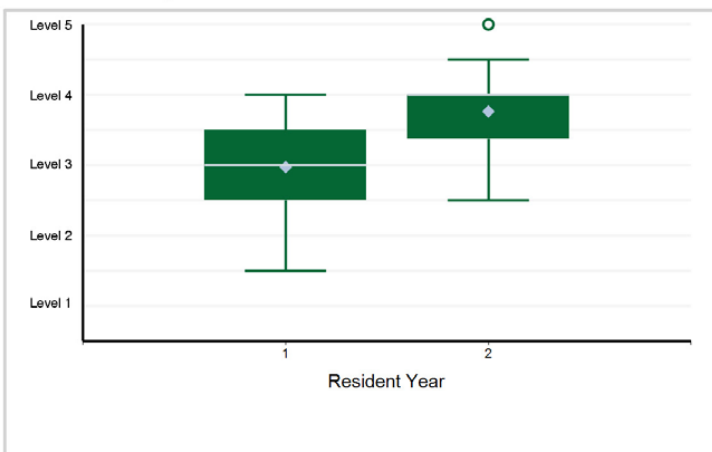

10. Practice-Based Learning and Improvement - Practice-Based Learning and Improvement 1: Evidence-Based and Informed Practice

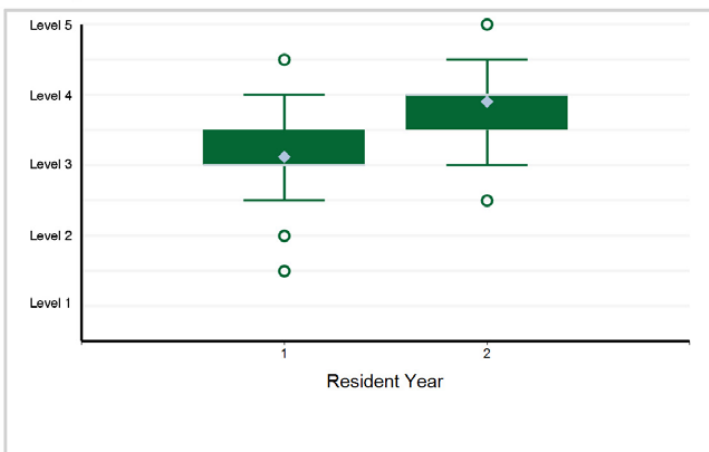

11. Practice-Based Learning and Improvement - Practice-Based Learning and Improvement 2: Reflective Practice and Commitment ...

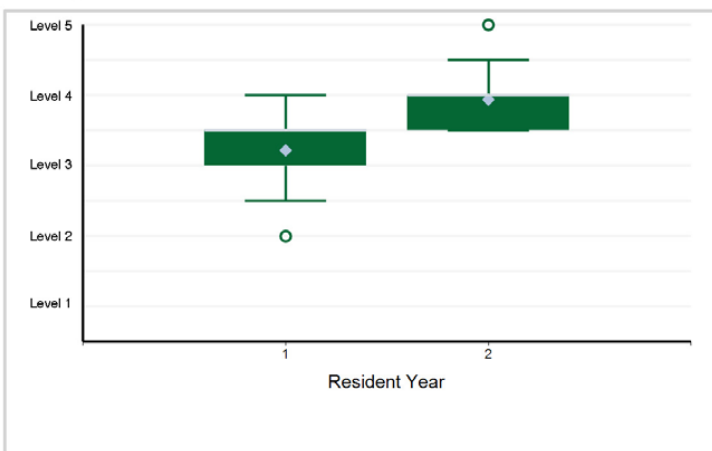

12. Professionalism - Professionalism 1: Professional Behavior and Ethical Principles

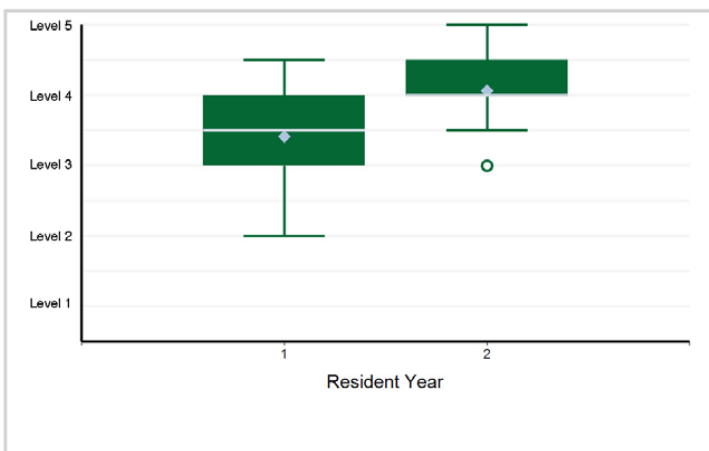

Specialty Box Plot Report - Milestone Evaluation by Resident Year: Year-End 2021-2022

SPECIALTY: Medical Genetics and Genomics

13. Professionalism - Professionalism 2: Accountability/Conscientiousness

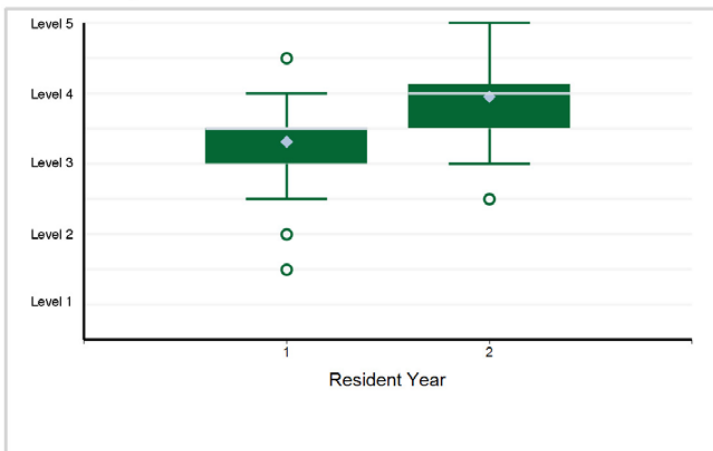

14. Professionalism - Professionalism 3: Self-Awareness and Help-Seeking

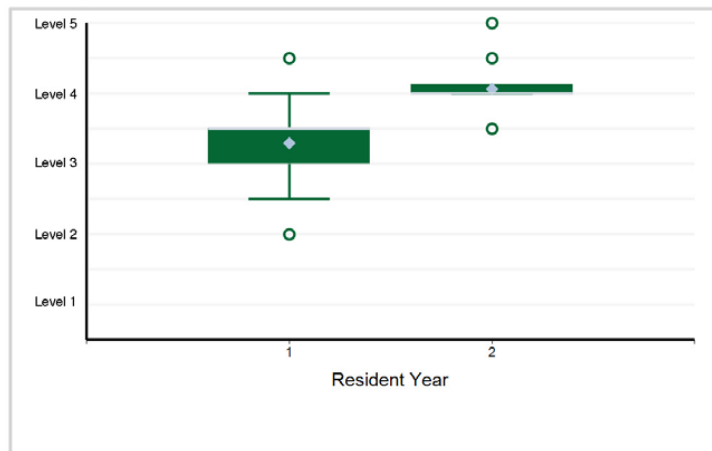

15. Interpersonal and Communication Skills - Interpersonal and Communication Skills 1: Patient and Family-Centered Communication

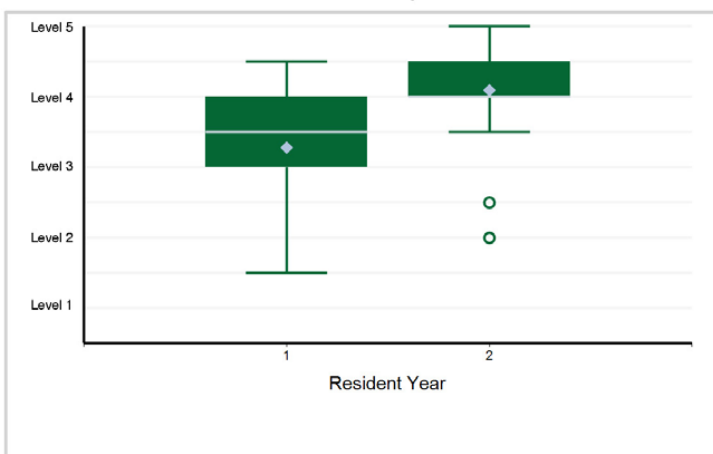

16. Interpersonal and Communication Skills - Interpersonal and Communication Skills 2: Interprofessional and Team Communication

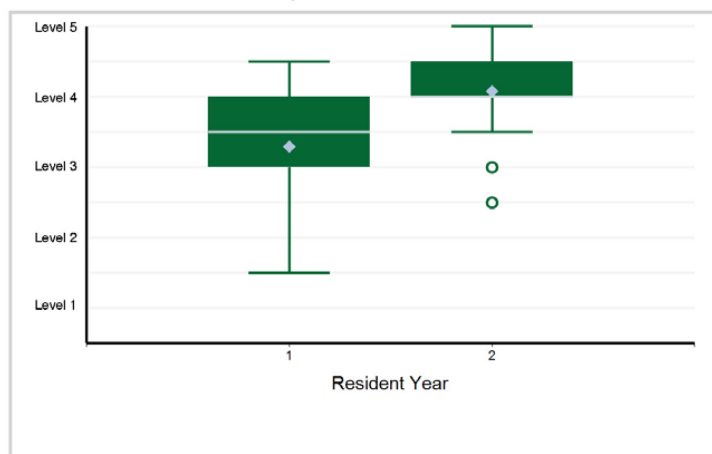

17. Interpersonal and Communication Skills - Interpersonal and Communication Skills 3: Communication within Health Care Systems

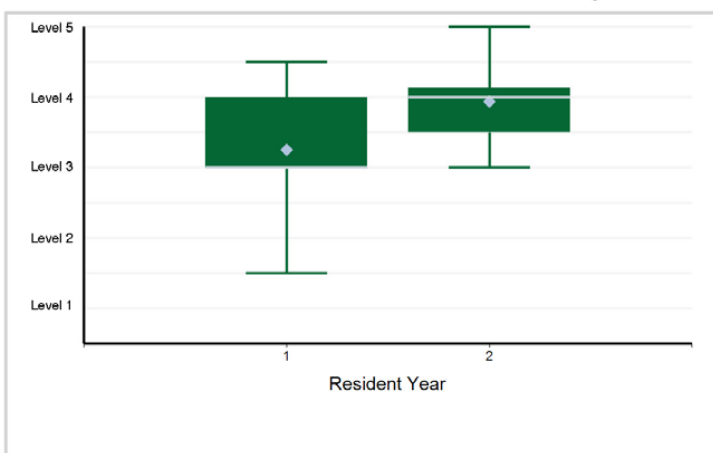

Specialty Box Plot Report - Milestone Evaluation by Resident Year: Year-End 2021-2022

TABLE 50: SPECIALTY: **Clinical Biochemical Genetics**

Resident Year	1	2	Total Residents
# of Residents	8	5	13

1. Patient Care - Patient Care 1: Pre-Analytic

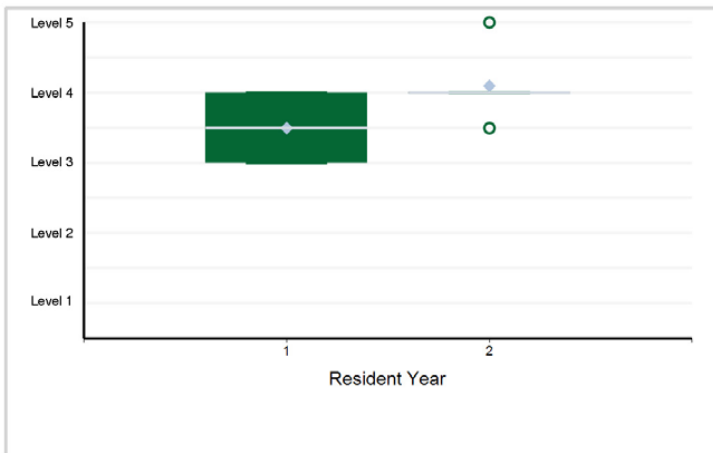

2. Patient Care - Patient Care 2: Analytic

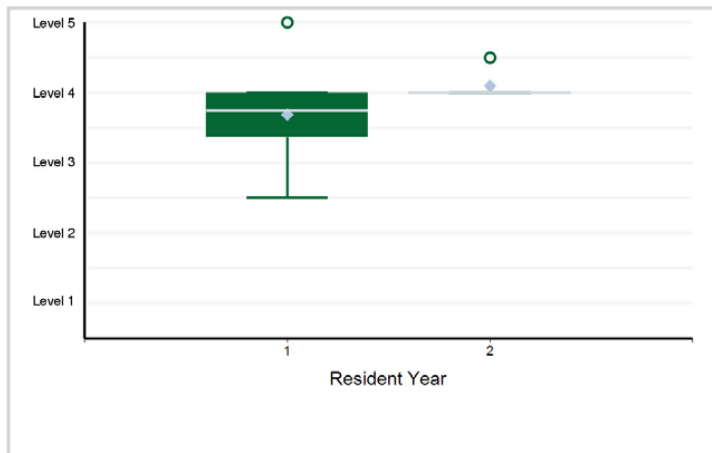

3. Patient Care - Patient Care 3: Post-Analytic Skills

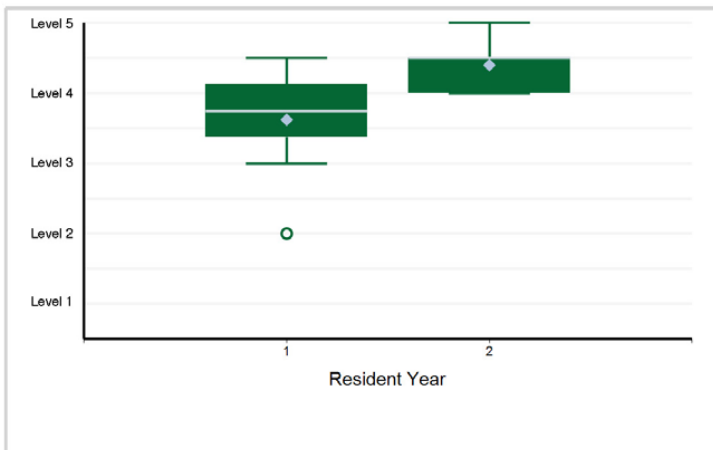

4. Patient Care - Patient Care 4: Reports

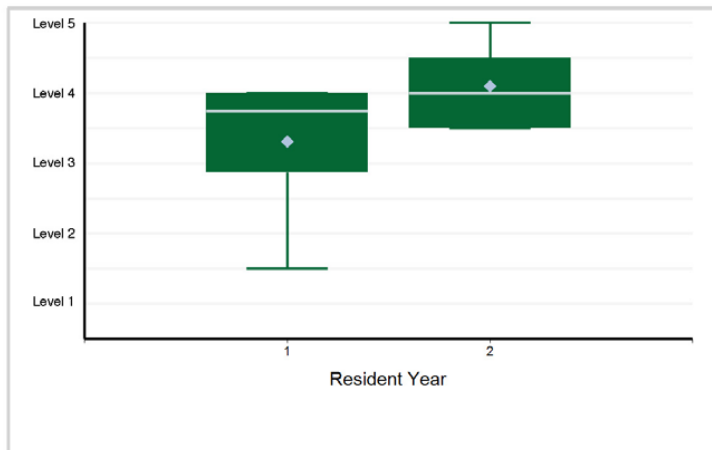

5. Medical Knowledge - Medical Knowledge 1: Foundations of Medical Genetics and Genomics

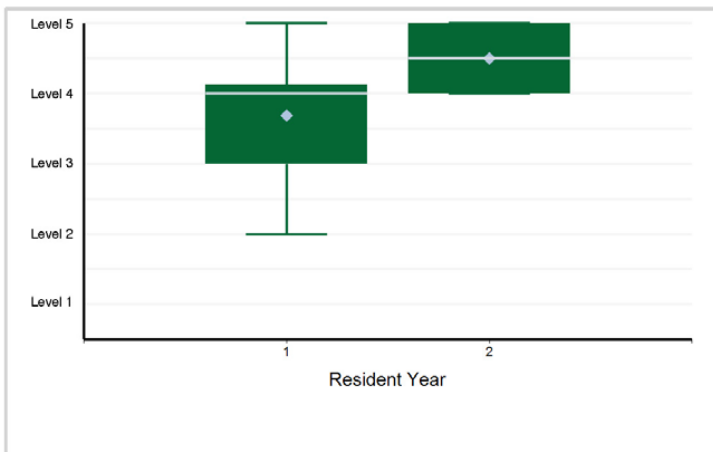

6. Medical Knowledge - Medical Knowledge 2: Testing

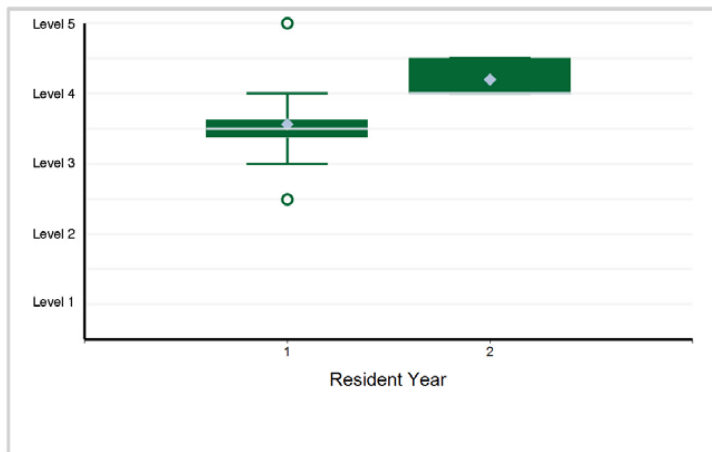

Specialty Box Plot Report - Milestone Evaluation by Resident Year: Year-End 2021-2022

SPECIALTY: Clinical Biochemical Genetics

7. Systems-Based Practice - Systems-Based Practice 1: Patient Safety and Quality Improvement (QI)

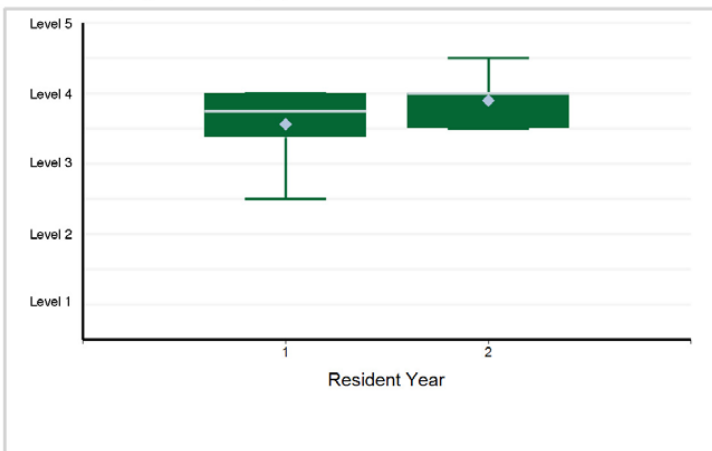

8. Systems-Based Practice - Systems-Based Practice 2: Systems Navigation for Patient-Centered Care

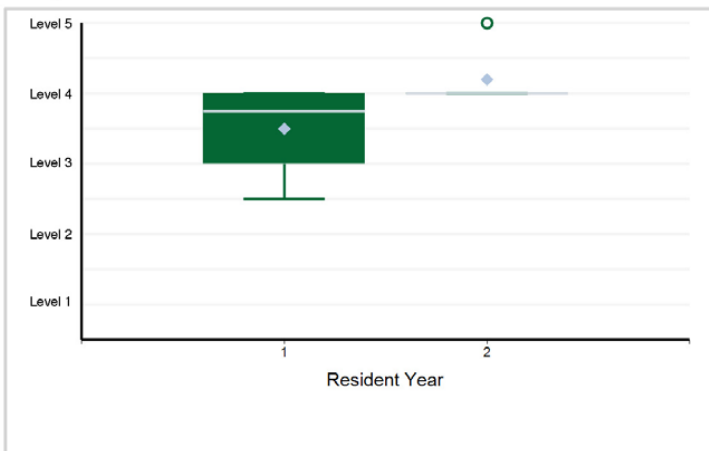

9. Systems-Based Practice - Systems-Based Practice 3: Laboratory Geneticist's Role in Health Care System

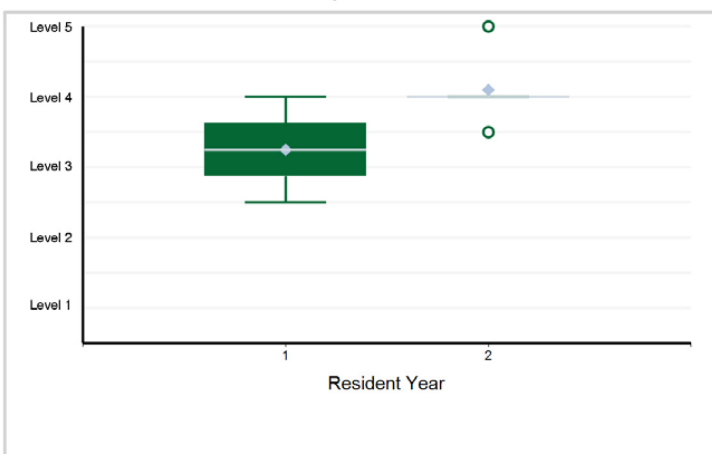

10. Systems-Based Practice - Systems-Based Practice 4: Accreditation, Compliance, and Quality Management

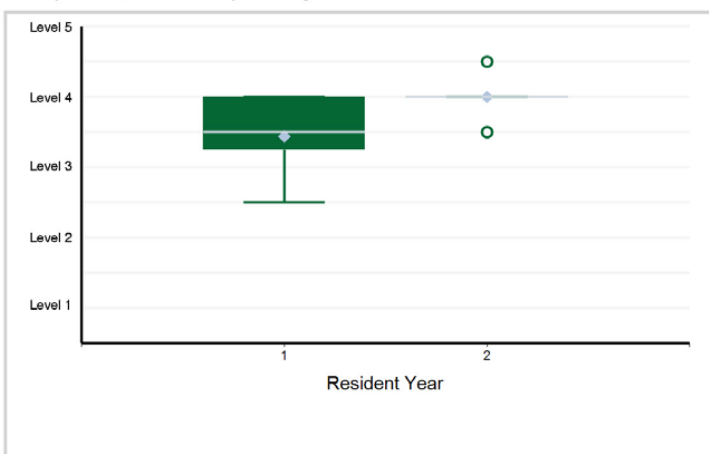

11. Systems-Based Practice - Systems-Based Practice 5: Informatics

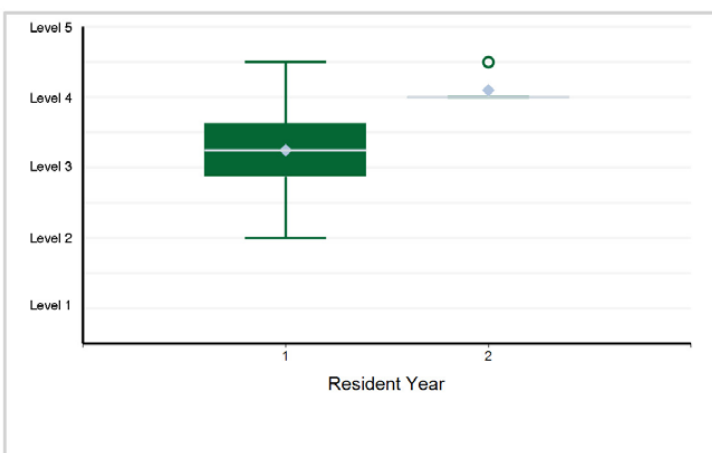

12. Practice-Based Learning and Improvement - Practice-Based Learning and Improvement 1: Evidence-Based Practice

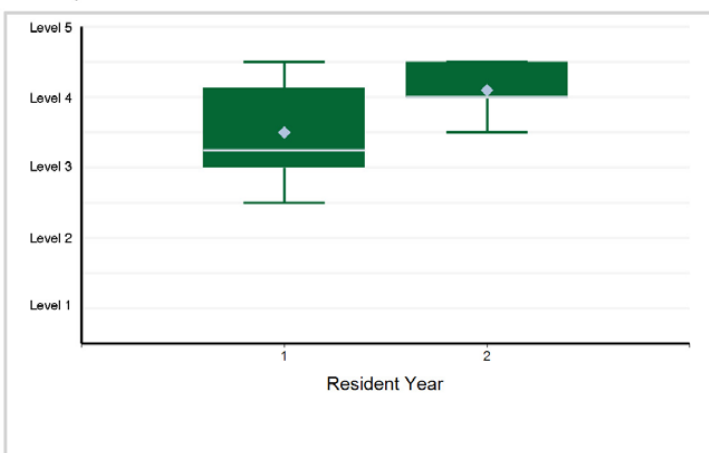

Specialty Box Plot Report - Milestone Evaluation by Resident Year: Year-End 2021-2022

SPECIALTY: Clinical Biochemical Genetics

13. Practice-Based Learning and Improvement - Practice-Based Learning and Improvement 2: Reflective Practice and Commitment ...

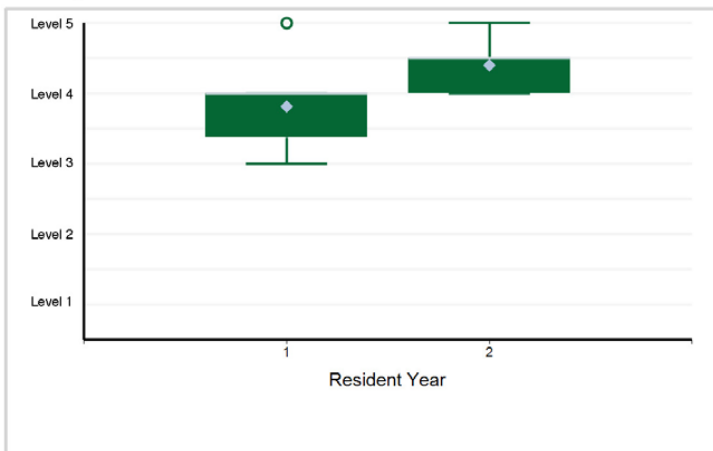

14. Professionalism - Professionalism 1: Professional Behavior and Ethical Principles

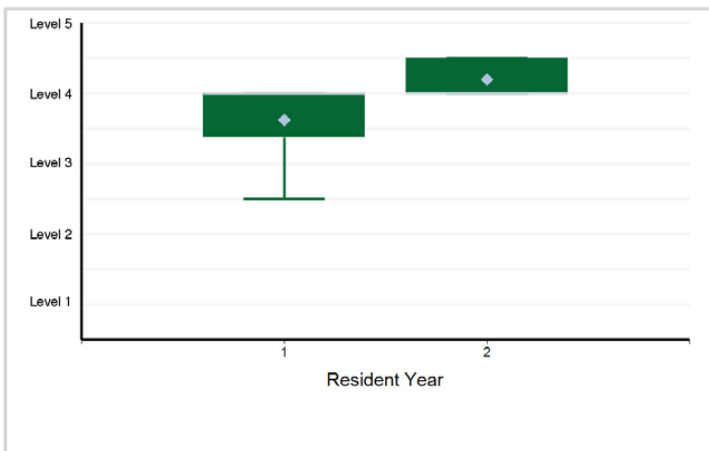

15. Professionalism - Professionalism 2: Accountability and Conscientiousness

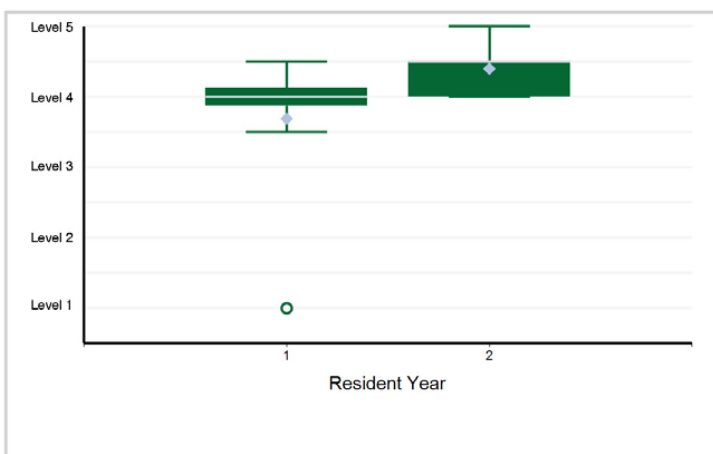

16. Professionalism - Professionalism 3: Personal and Professional Well-Being

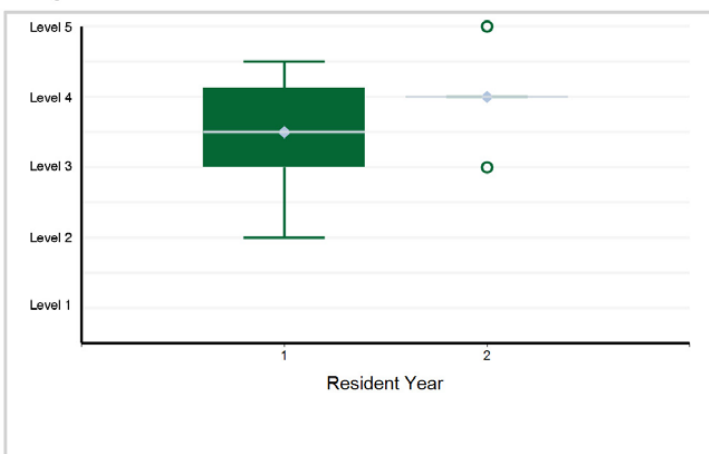

17. Interpersonal and Communication Skills - Interpersonal and Communication Skills 1: Patient- and Family-Centered Communication

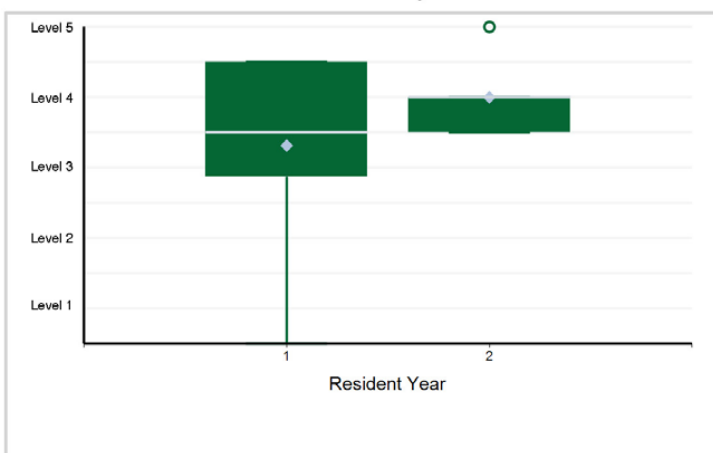

18. Interpersonal and Communication Skills - Interpersonal and Communication Skills 2: Interprofessional and Team Communication

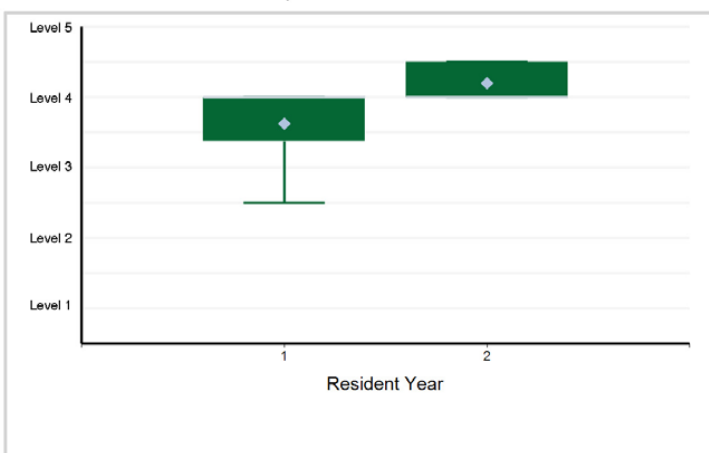

Specialty Box Plot Report - Milestone Evaluation by Resident Year: Year-End 2021-2022

SPECIALTY: Clinical Biochemical Genetics

19. Interpersonal and Communication Skills - Interpersonal and Communication Skills 3: Communication within Health Care Systems

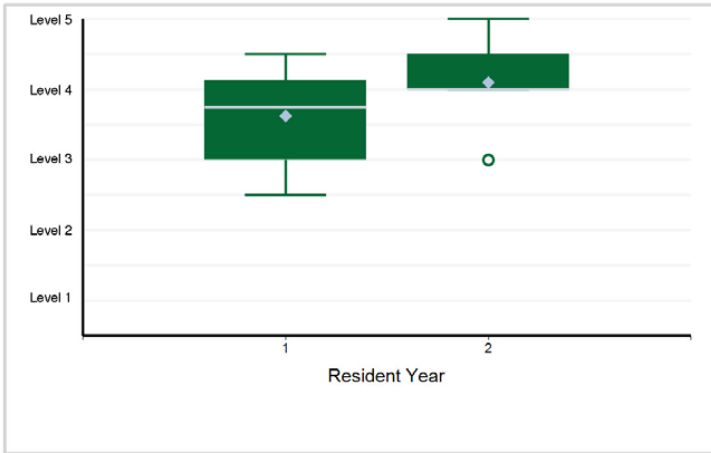

Specialty Box Plot Report - Milestone Evaluation by Resident Year: Year-End 2021-2022

TABLE 51: SPECIALTY: **Laboratory Genetics and Genomics**

Resident Year	1	2	Total Residents
# of Residents	31	35	66

1. Patient Care - Patient Care 1: Pre-Analytic

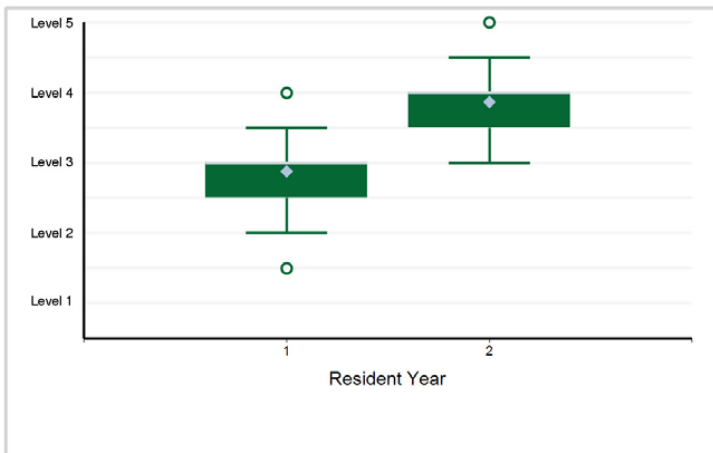

2. Patient Care - Patient Care 2: Analytic

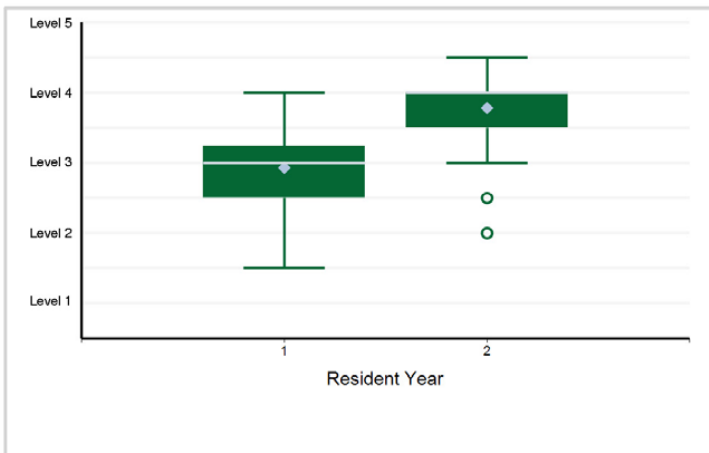

3. Patient Care - Patient Care 3: Post-Analytic Skills

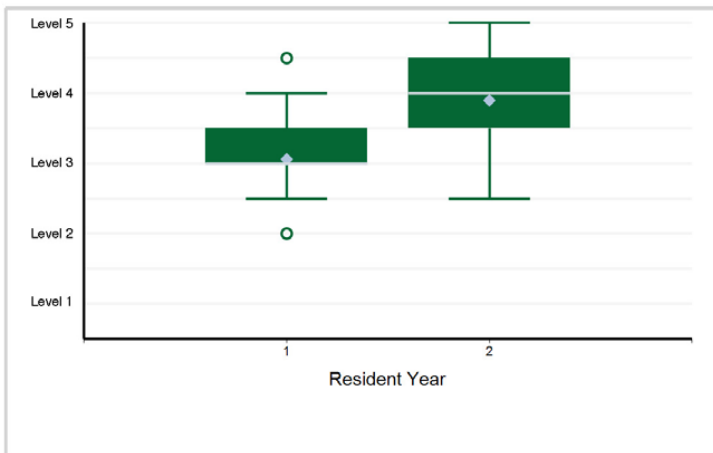

4. Patient Care - Patient Care 4: Reports

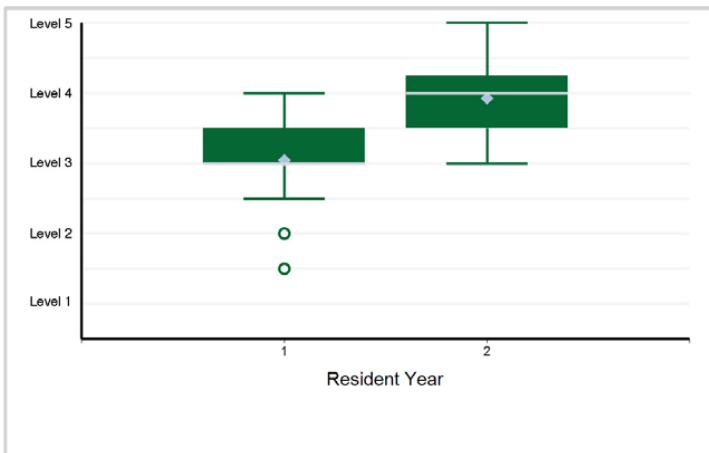

5. Medical Knowledge - Medical Knowledge 1: Foundations of Medical Genetics and Genomics

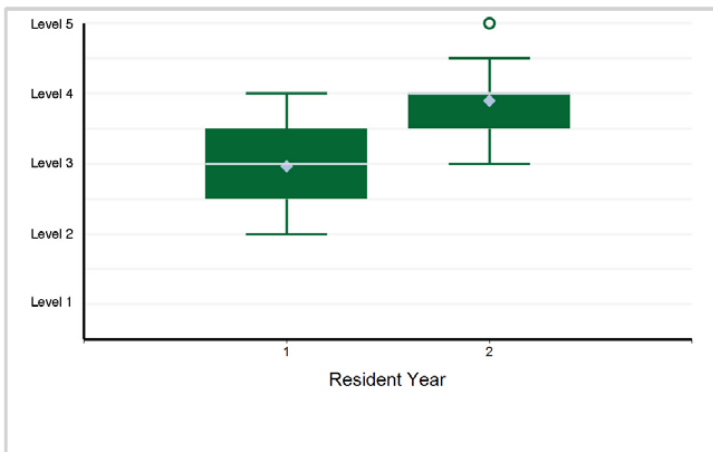

6. Medical Knowledge - Medical Knowledge 2: Testing

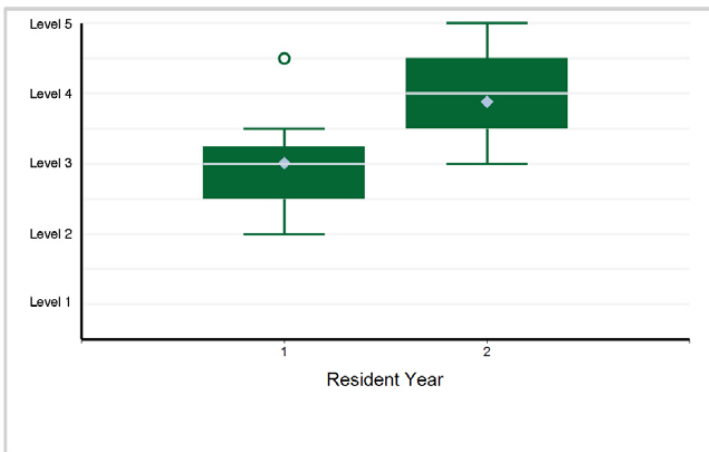

Specialty Box Plot Report - Milestone Evaluation by Resident Year: Year-End 2021-2022

SPECIALTY: Laboratory Genetics and Genomics

7. Systems-Based Practice - Systems-Based Practice 1: Patient Safety and Quality Improvement (QI)

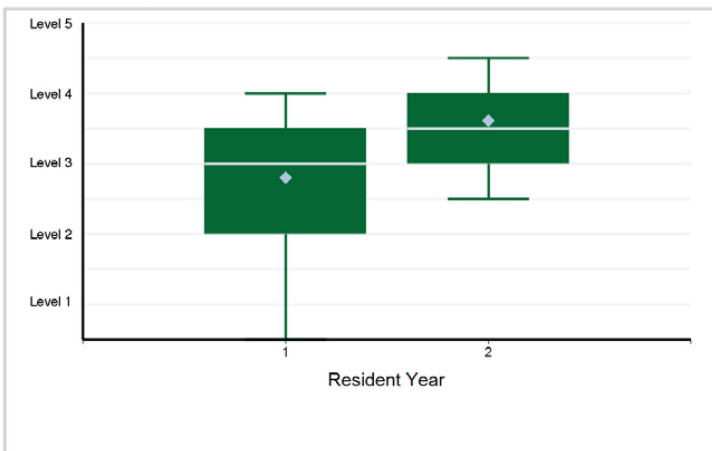

8. Systems-Based Practice - Systems-Based Practice 2: Systems Navigation for Patient-Centered Care

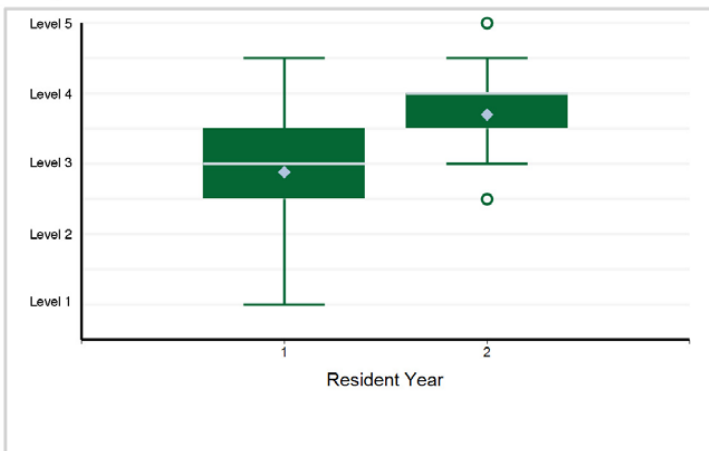

9. Systems-Based Practice - Systems-Based Practice 3: Laboratory Geneticist's Role in Health Care System

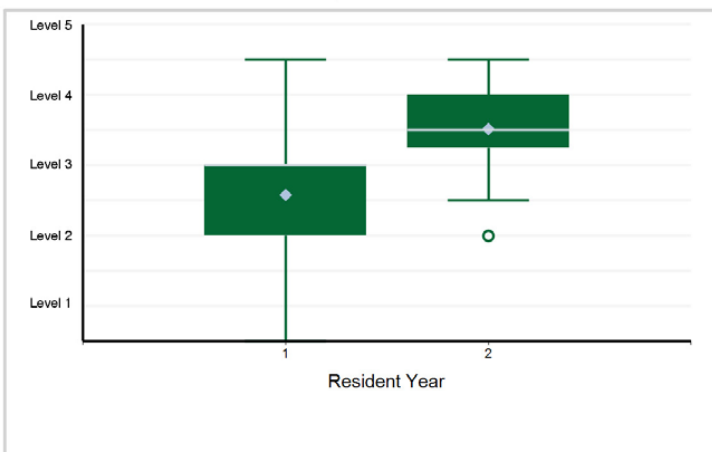

10. Systems-Based Practice - Systems-Based Practice 4: Accreditation, Compliance, and Quality Management

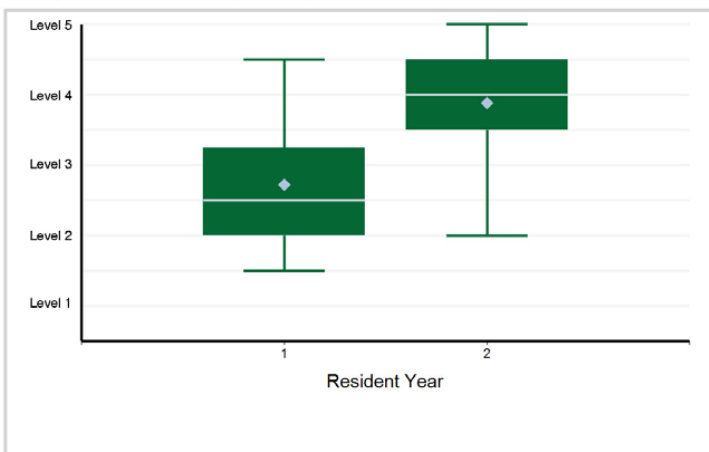

11. Systems-Based Practice - Systems-Based Practice 5: Informatics

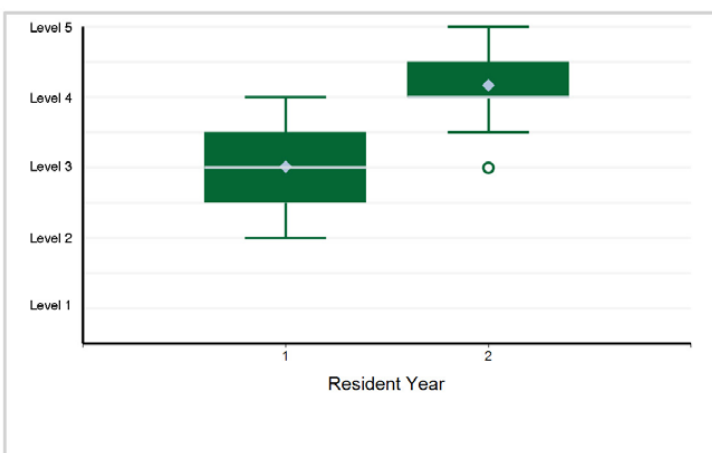

12. Practice-Based Learning and Improvement - Practice-Based Learning and Improvement 1: Evidence-Based Practice

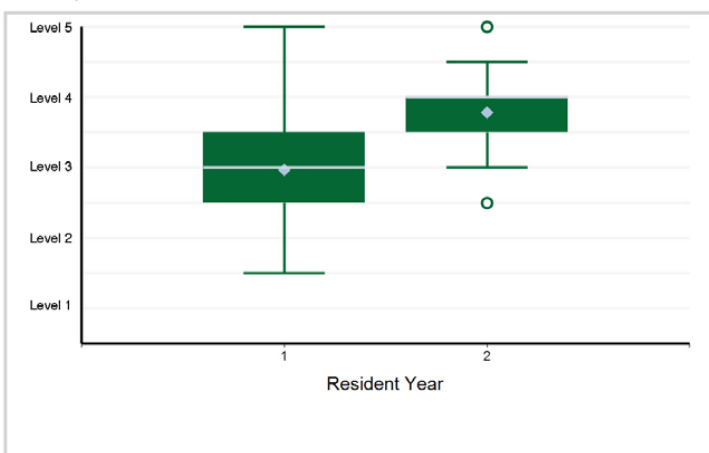

Specialty Box Plot Report - Milestone Evaluation by Resident Year: Year-End 2021-2022

SPECIALTY: Laboratory Genetics and Genomics

13. Practice-Based Learning and Improvement - Practice-Based Learning and Improvement 2: Reflective Practice and Commitment ...

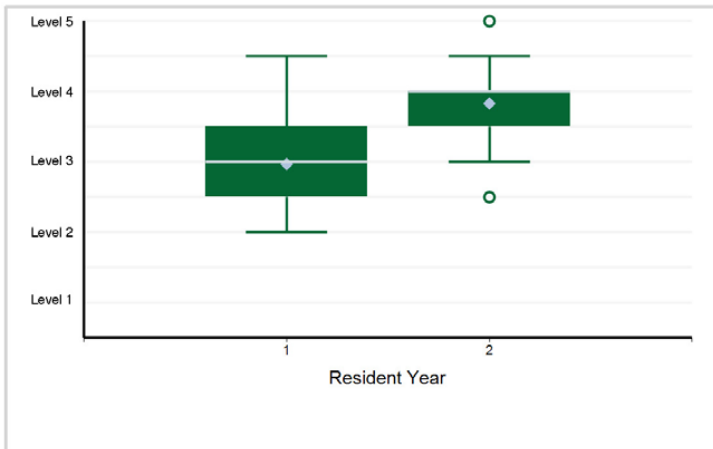

14. Professionalism - Professionalism 1: Professional Behavior and Ethical Principles

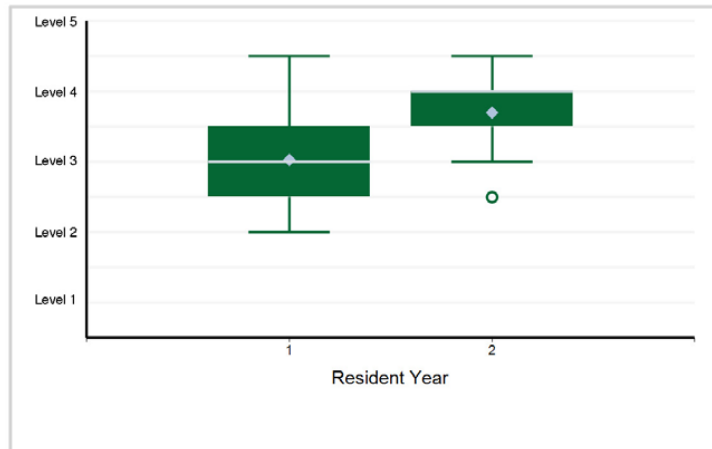

15. Professionalism - Professionalism 2: Accountability and Conscientiousness

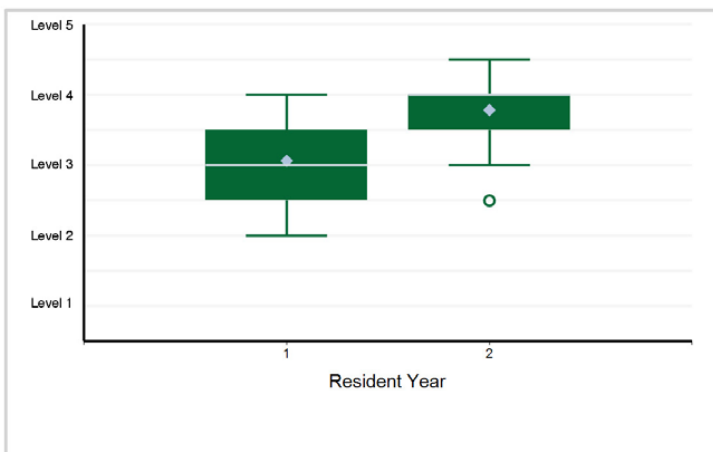

16. Professionalism - Professionalism 3: Personal and Professional Well-Being

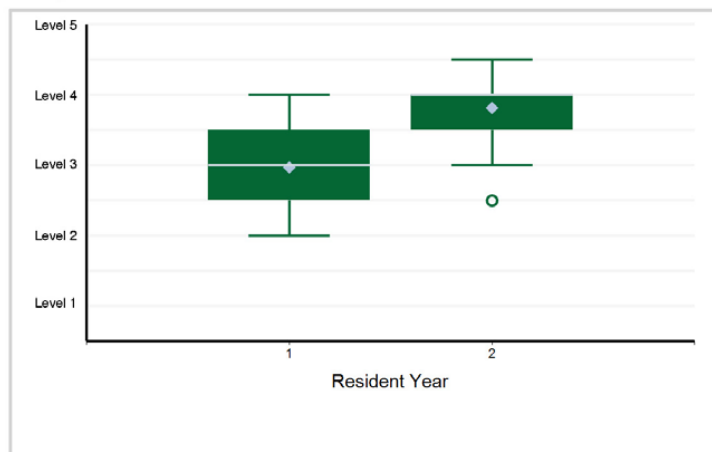

17. Interpersonal and Communication Skills - Interpersonal and Communication Skills 1: Patient and Family-Centered Communication

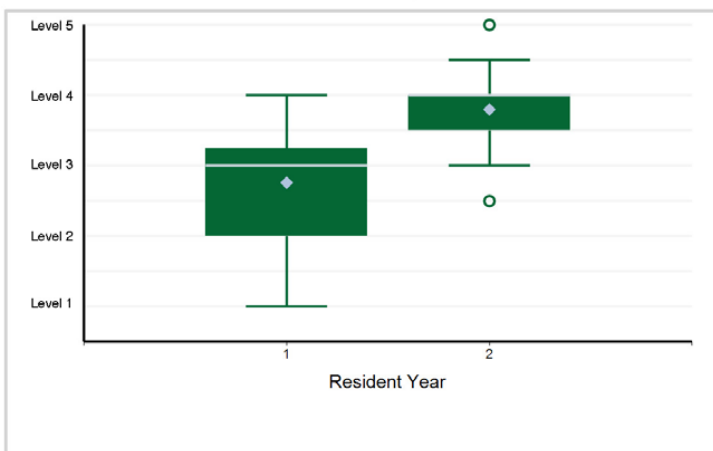

18. Interpersonal and Communication Skills - Interpersonal and Communication Skills 2: Interprofessional and Team Communication

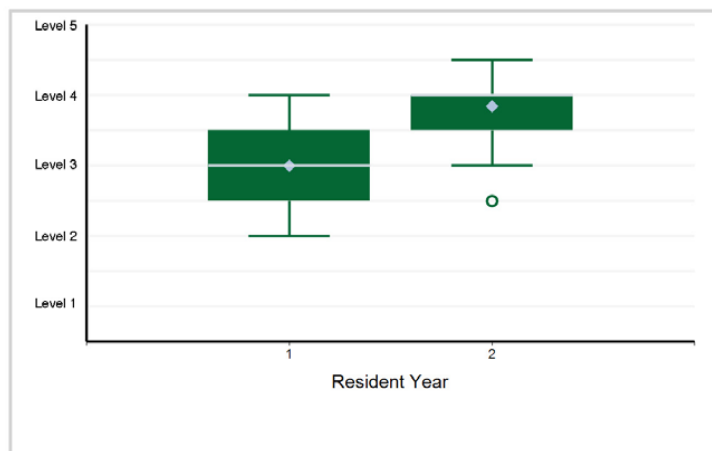

Specialty Box Plot Report - Milestone Evaluation by Resident Year: Year-End 2021-2022

SPECIALTY: **Laboratory Genetics and Genomics**

19. Interpersonal and Communication Skills - Interpersonal and Communication Skills 3: Communication within Health Care Systems

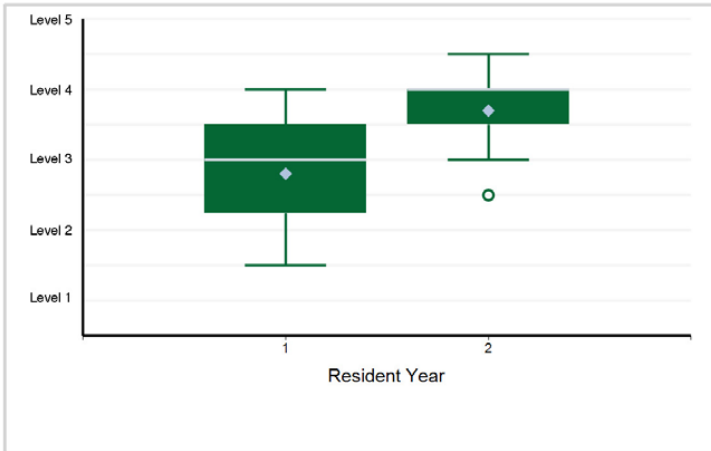

Specialty Box Plot Report - Milestone Evaluation by Resident Year: Year-End 2021-2022

TABLE 52: SUBSPECIALTY: **Medical Biochemical Genetics**

Resident Year	1	Total Residents
# of Residents	17	17

1. Patient Care - Initial or Acute Management — Patient Care 1

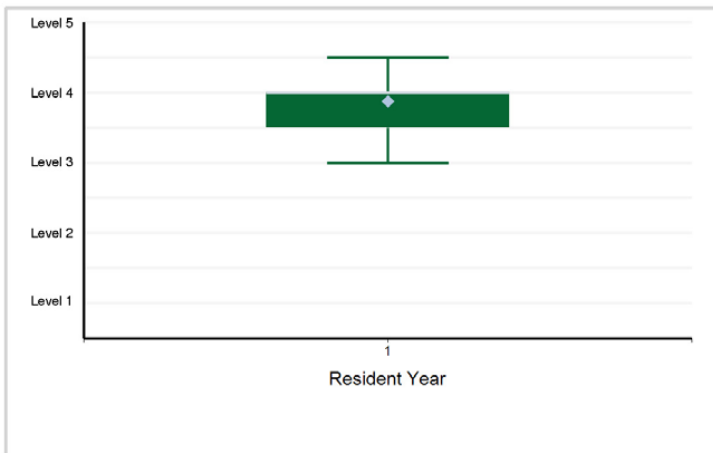

2. Patient Care - Chronic Management — Patient Care 2



3. Patient Care - Newborn Screening (NBS) — Patient Care 3

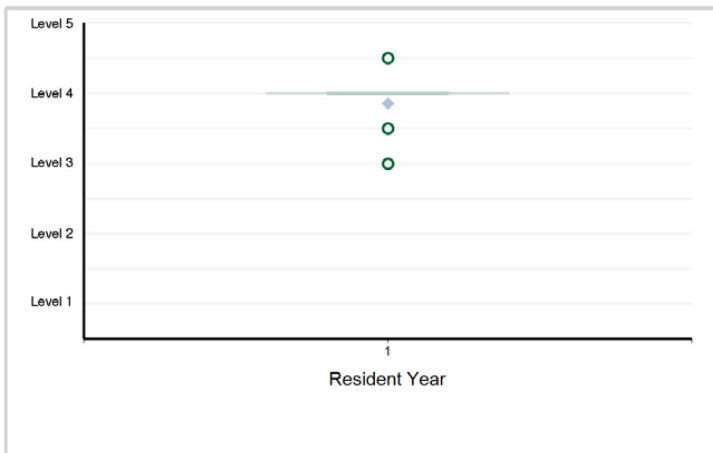

4. Medical Knowledge - Molecular and Metabolic Mechanisms — Medical Knowledge 1

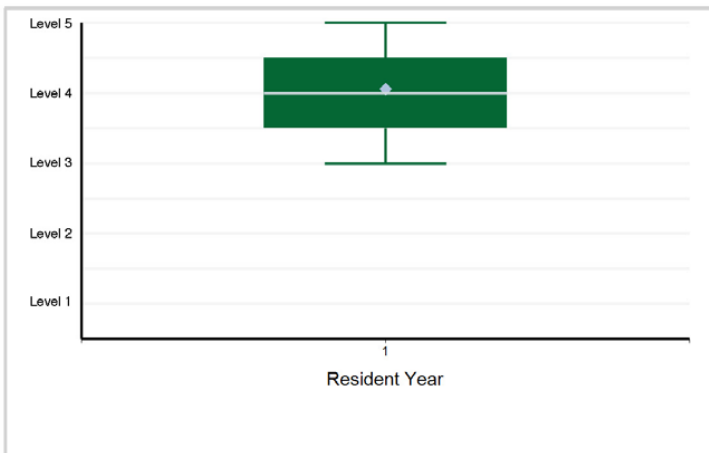

5. Medical Knowledge - Newborn Screening (NBS) — Medical Knowledge 2

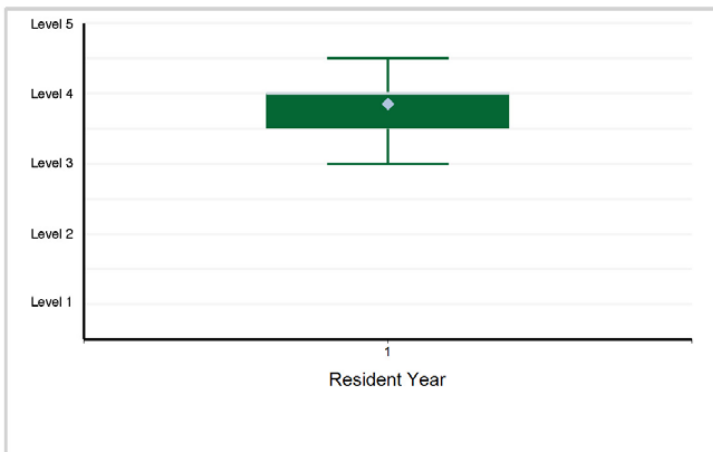

6. Medical Knowledge - Diagnostic Testing — Medical Knowledge 3

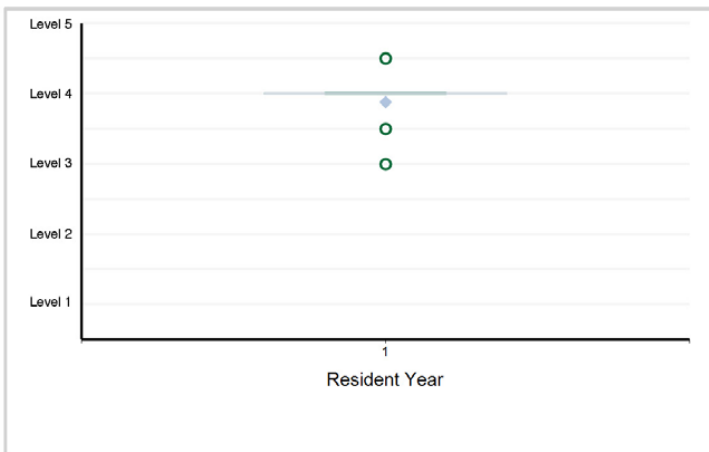

Specialty Box Plot Report - Milestone Evaluation by Resident Year: Year-End 2021-2022

SUBSPECIALTY: Medical Biochemical Genetics

7. Systems-Based Practice - Systems Approach — Systems-Based Practice 1

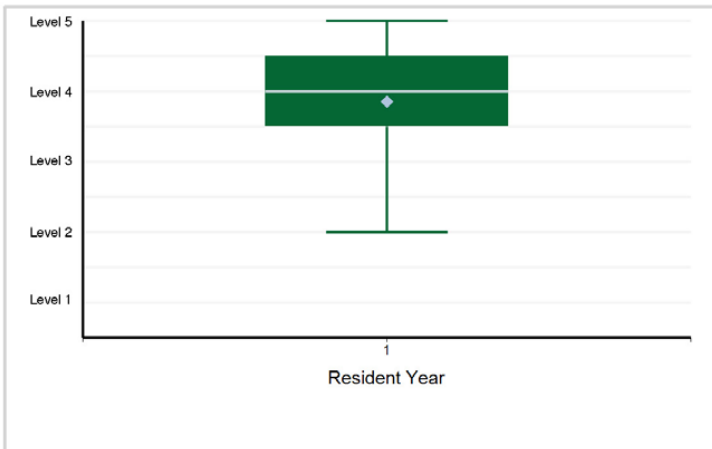

8. Systems-Based Practice - Newborn Screening Systems — Systems-Based Practice 2

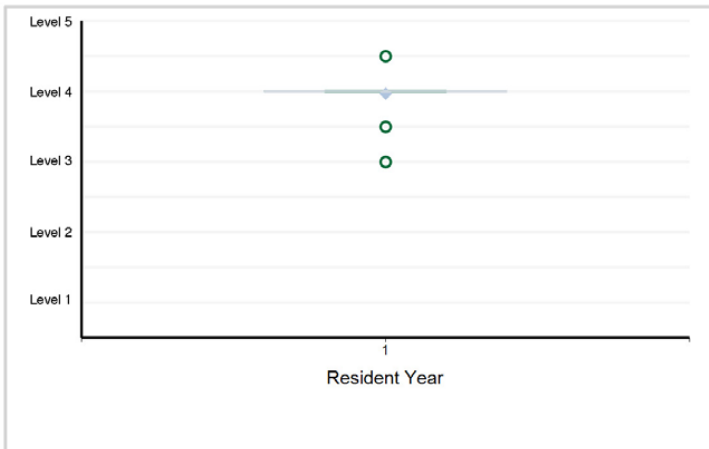

9. Systems-Based Practice - Transitions of Care — Systems-Based Practice 3

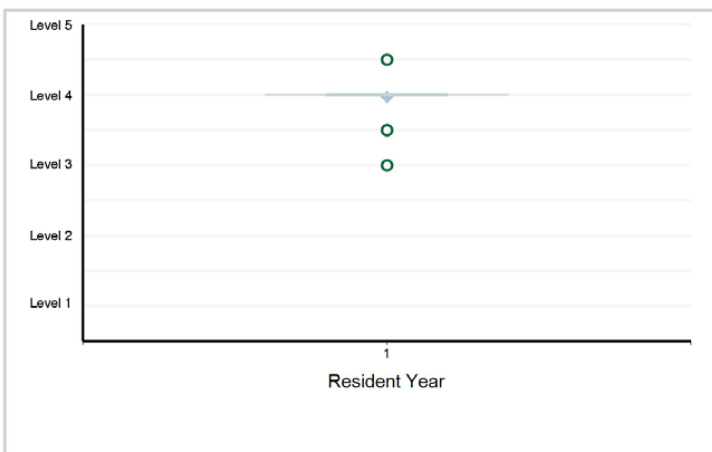

10. Practice-Based Learning and Improvement - Self-Directed Learning — Practice-Based Learning and Improvement 1

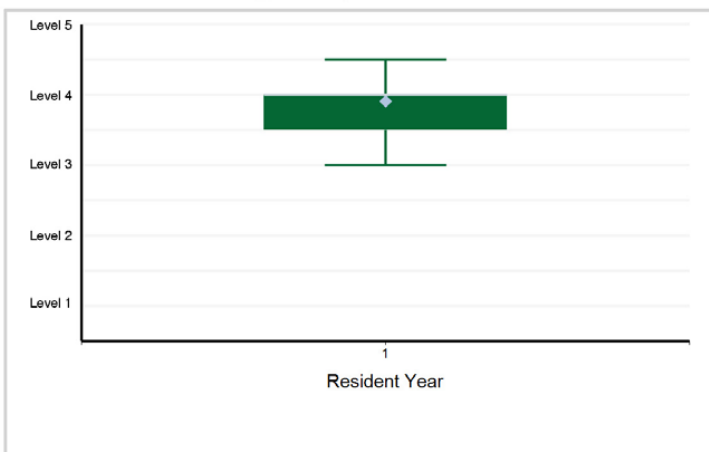

11. Practice-Based Learning and Improvement - Process Improvement and Patient Safety — Practice-Based Learning ...

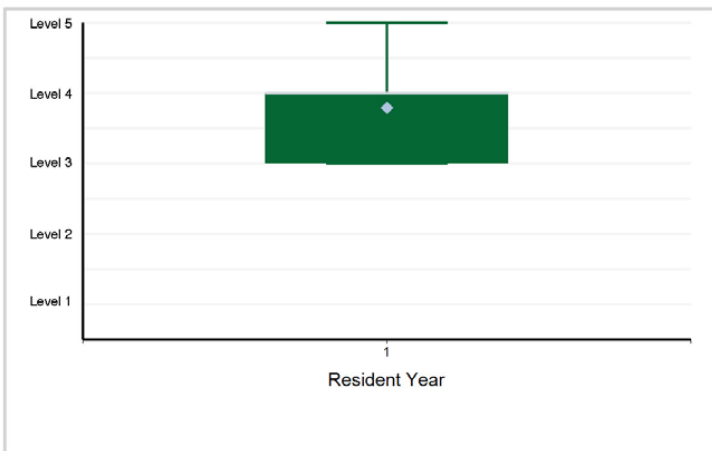

12. Professionalism - Giving and Receiving Feedback — Professionalism 1

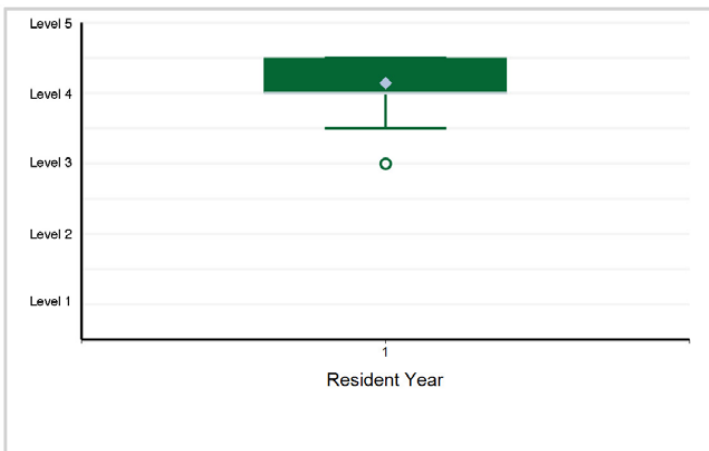

Specialty Box Plot Report - Milestone Evaluation by Resident Year: Year-End 2021-2022

SUBSPECIALTY: Medical Biochemical Genetics

13. Professionalism - Cultural Competency — Professionalism 2

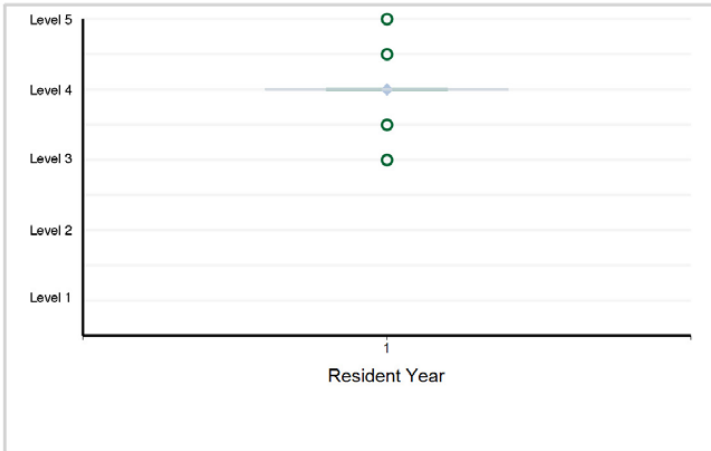

14. Professionalism - Accountability and Integrity — Professionalism 3

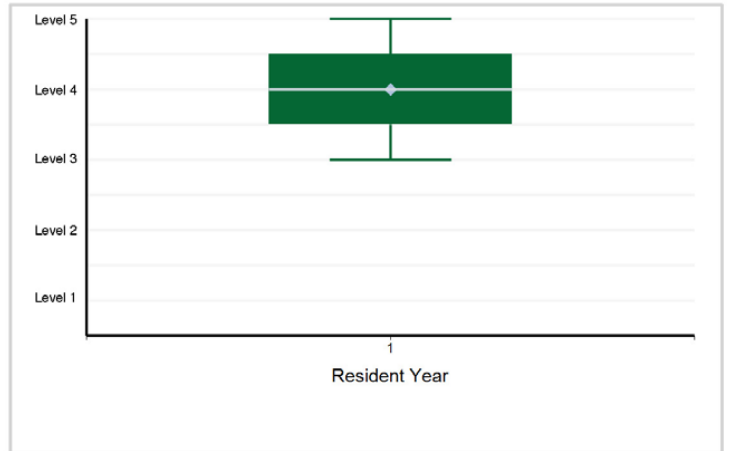

15. Interpersonal and Communication Skills - Communicates with Patients and Families — Interpersonal and ...

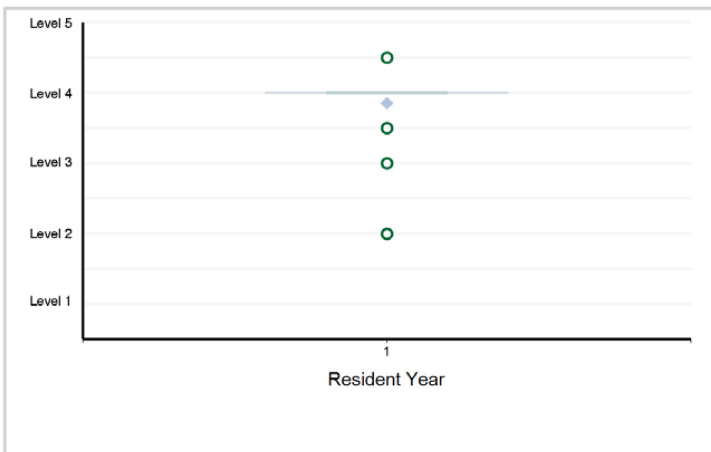

16. Interpersonal and Communication Skills - Communication and Conflict Management within the Health Care ...

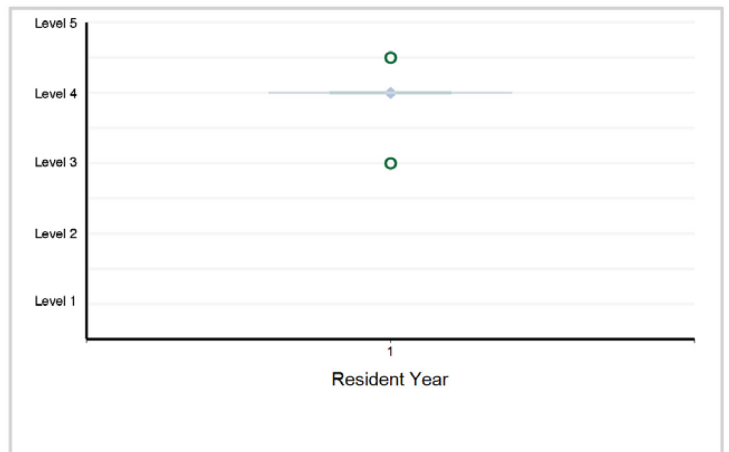

Specialty Box Plot Report - Milestone Evaluation by Resident Year: Year-End 2021-2022

TABLE 53: SUBSPECIALTY: **Molecular Genetic Pathology (multidisciplinary, Medical Genetics and Genomics)**

Resident Year	1	Total Residents
# of Residents	59	59

1. Patient Care - Patient Care 1: Quality Assurance and Quality Management

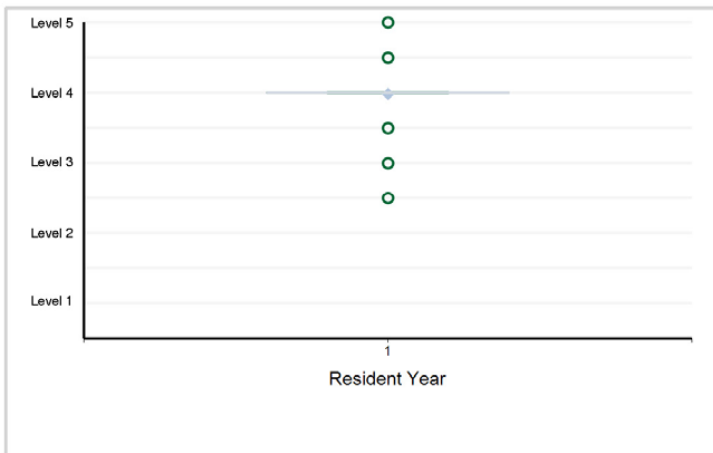

2. Patient Care - Patient Care 2: Interpretation of Molecular and Genetic Testing

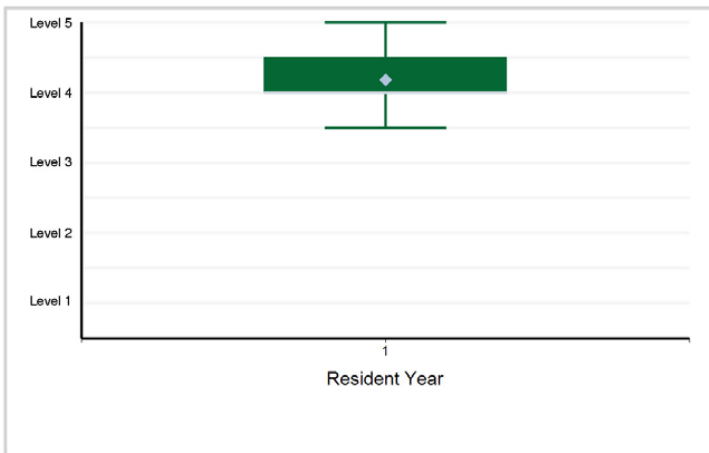

3. Patient Care - Patient Care 3: Interdisciplinary Consultation

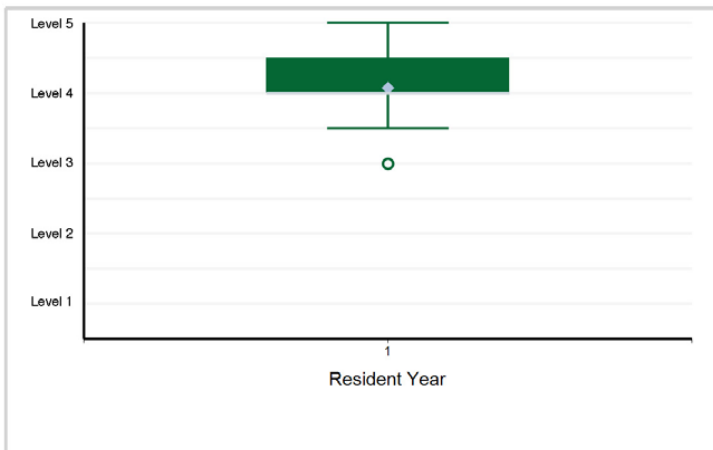

4. Medical Knowledge - Medical Knowledge 1: Molecular Testing with Various Platforms (Diagnosis, Management, Prognostication)

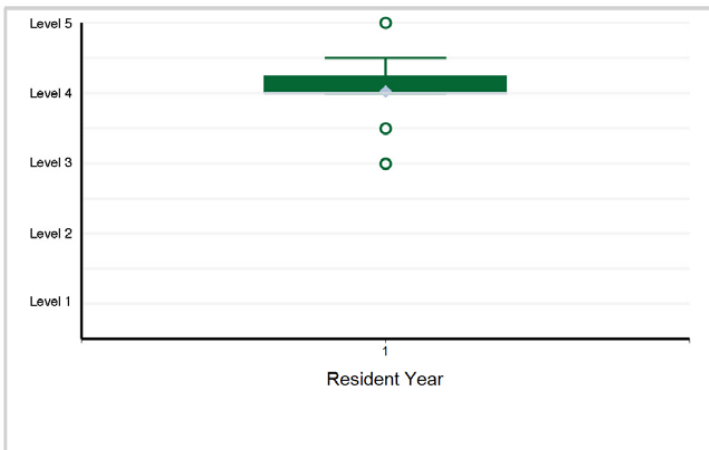

5. Medical Knowledge - Medical Knowledge 2: Genomic Testing, Genomic Databases, and Bioinformatics



6. Medical Knowledge - Medical Knowledge 3: Patient-Centered Interpretation

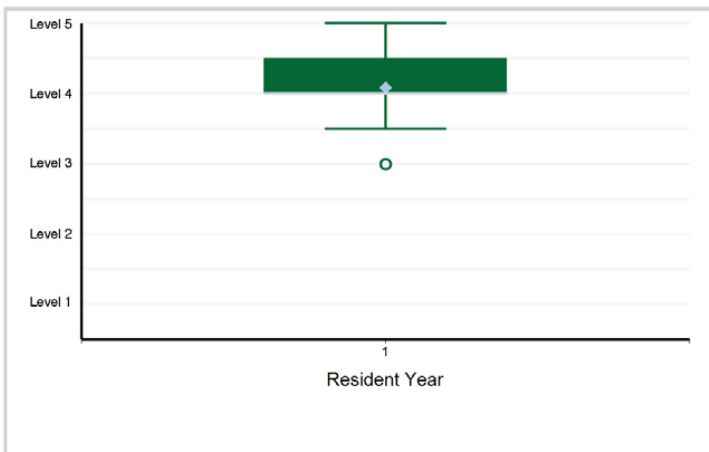

Specialty Box Plot Report - Milestone Evaluation by Resident Year: Year-End 2021-2022

SUBSPECIALTY: Molecular Genetic Pathology (multidisciplinary, Medical Genetics and Genomics)

7. Medical Knowledge - Medical Knowledge 4: Assay Design and Verification/Validation (e.g., Wet Labs, Troubleshooting)

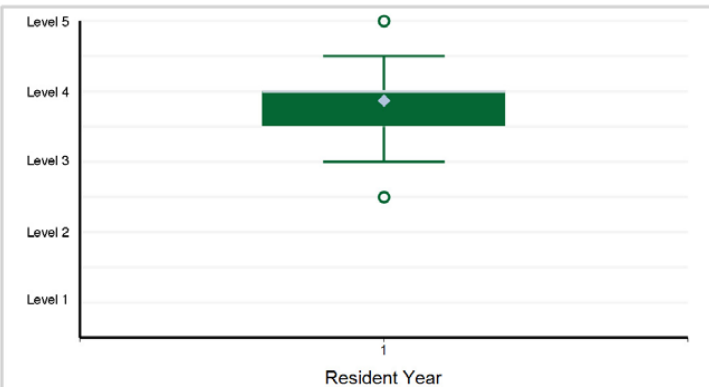

Note: 1 of 59 residents have a status of "Not Yet Rotated" and are not included in the analysis.

8. Systems-Based Practice - Systems-Based Practice 1: Patient Safety and Quality Improvement (QI)

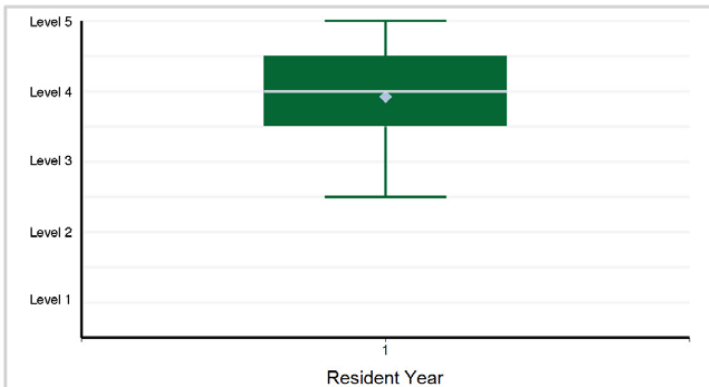

9. Systems-Based Practice - Systems-Based Practice 2: Systems Navigation for Patient-Centered Care

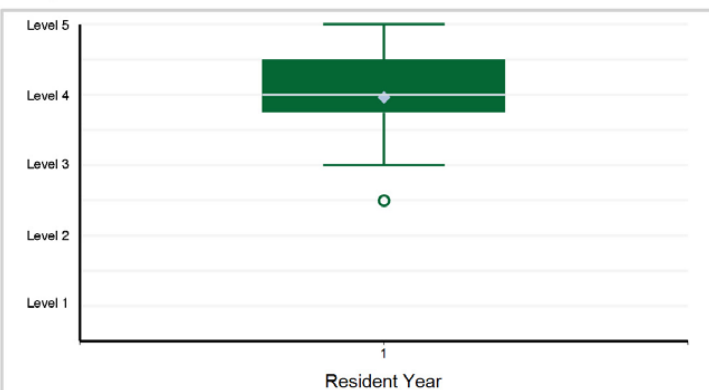

10. Systems-Based Practice - Systems-Based Practice 3: Community Health

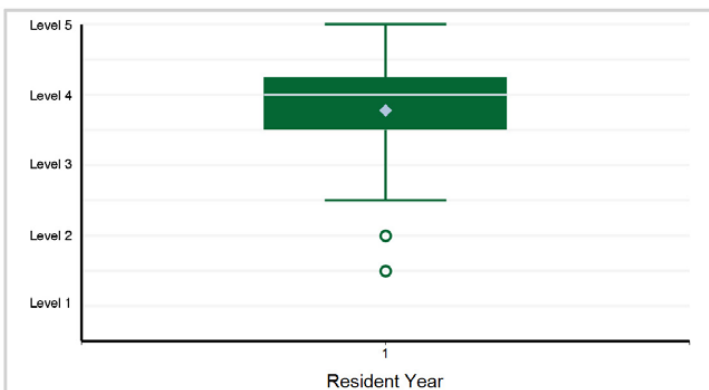

11. Systems-Based Practice - Systems-Based Practice 4: Physician Role in Health Care System

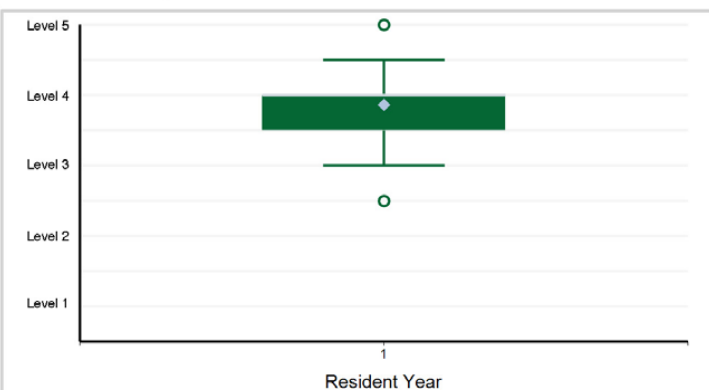

12. Systems-Based Practice - Systems-Based Practice 5: Accreditation, Compliance, and Quality

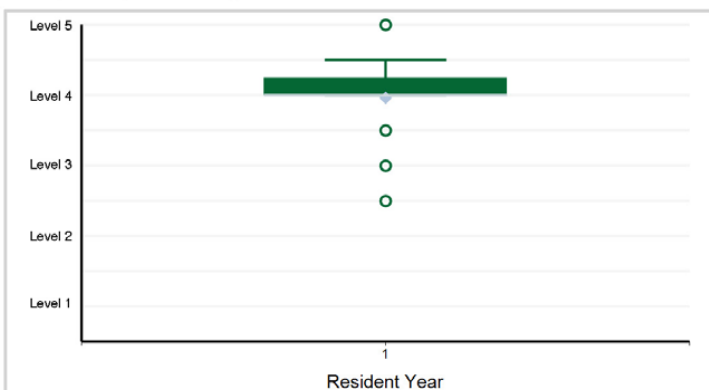

Specialty Box Plot Report - Milestone Evaluation by Resident Year: Year-End 2021-2022

SUBSPECIALTY: Molecular Genetic Pathology (multidisciplinary, Medical Genetics and Genomics)

13. Systems-Based Practice - Systems-Based Practice 6: Utilization

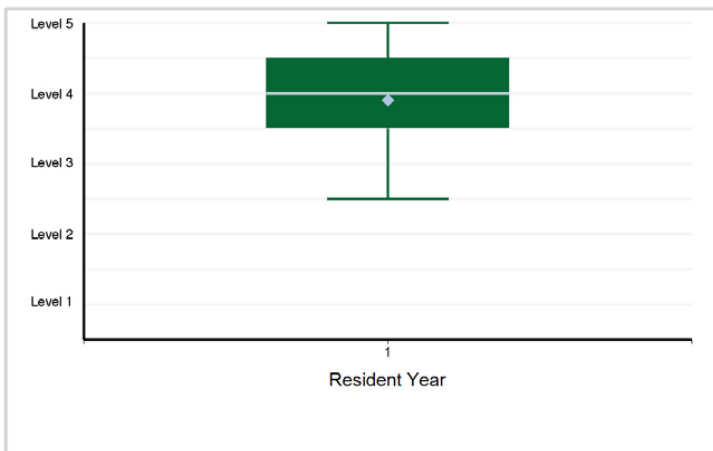

14. Practice-Based Learning and Improvement - Practice-Based Learning and Improvement 1: Evidence-Based Practice and Scholarship

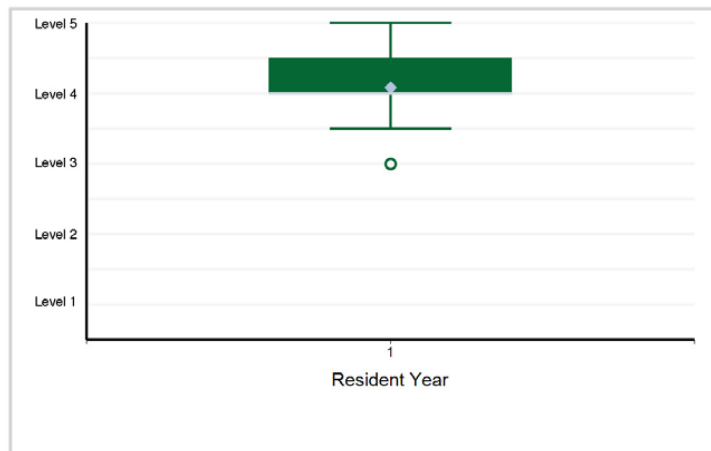

15. Practice-Based Learning and Improvement - Practice-Based Learning and Improvement 2: Research

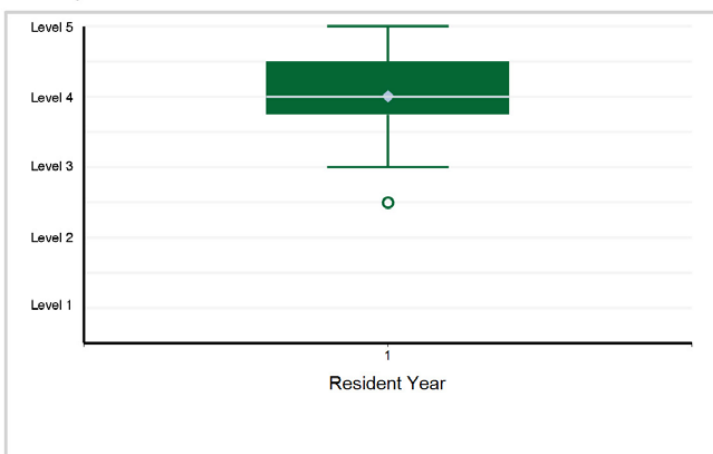

16. Practice-Based Learning and Improvement - Practice-Based Learning and Improvement 3: Reflective Practice and Commitment ...

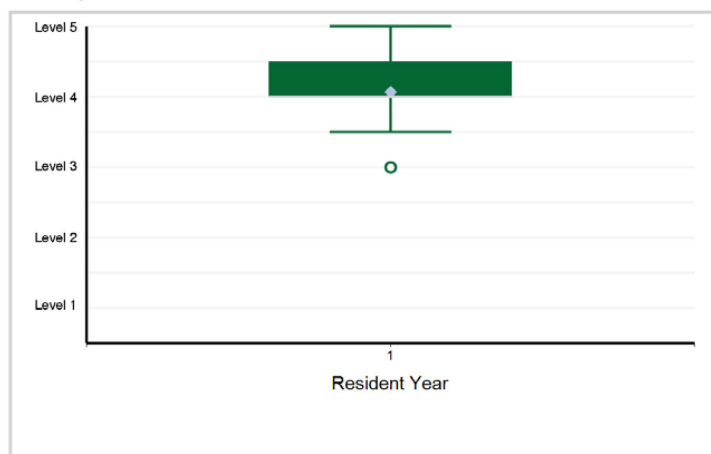

17. Professionalism - Professionalism 1: Professional Behavior and Ethical Principles

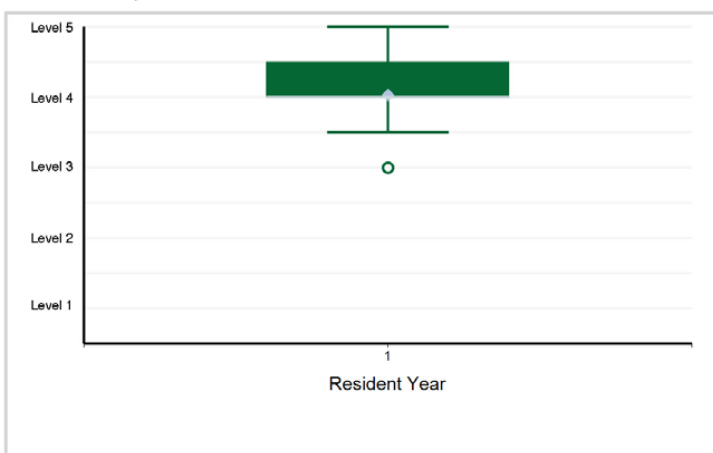

18. Professionalism - Professionalism 2: Accountability and Conscientiousness

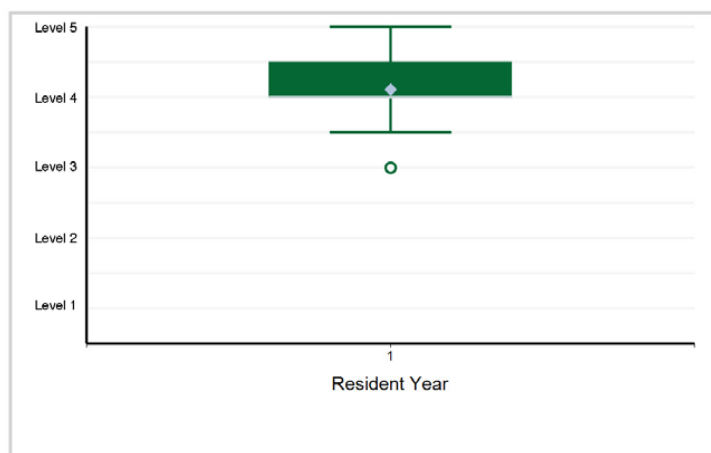

Specialty Box Plot Report - Milestone Evaluation by Resident Year: Year-End 2021-2022

SUBSPECIALTY: Molecular Genetic Pathology (multidisciplinary, Medical Genetics and Genomics)

19. Professionalism - Professionalism 3: Self-Awareness and Help-Seeking

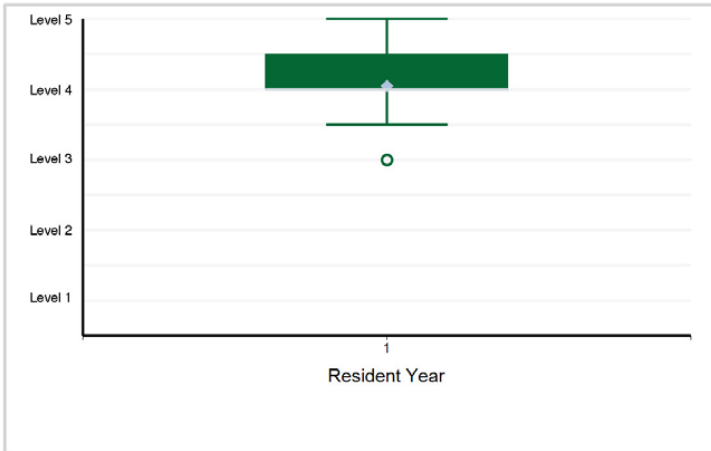

20. Interpersonal and Communication Skills - Interpersonal and Communication Skills 1: Patient- and Family-Centered Communication

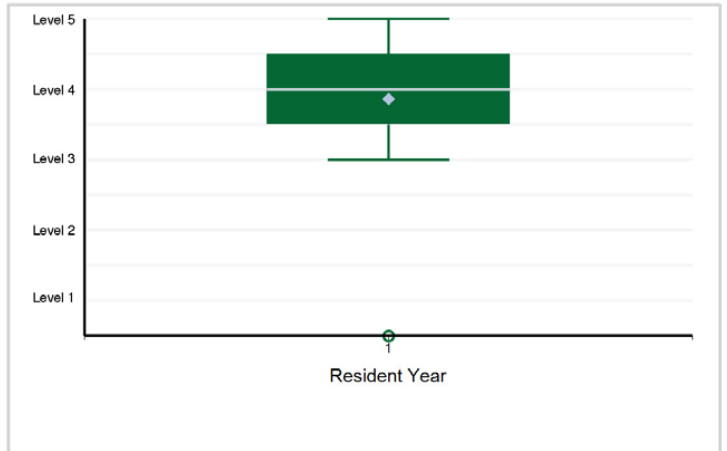

21. Interpersonal and Communication Skills - Interpersonal and Communication Skills 2: Interprofessional and Team Communication

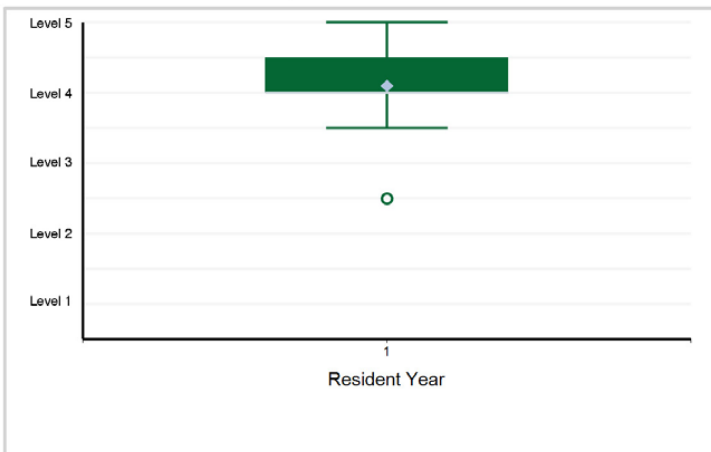

22. Interpersonal and Communication Skills - Interpersonal and Communication Skills 3: Communication within Health Care Systems

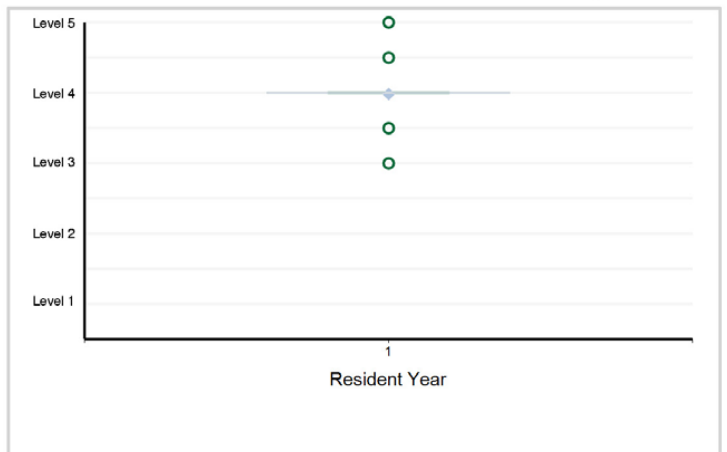

Specialty Box Plot Report - Milestone Evaluation by Resident Year: Year-End 2021-2022

TABLE 54: SPECIALTY: **Neurological Surgery**

Resident Year	1	2	3	4	5	6	7	Total Residents*
# of Residents	237	239	232	212	218	222	222	1,582

*Note: There are 1 residents with an incomplete milestone evaluation that are excluded from the box plots below.

1. Patient Care - 1: Brain Tumor

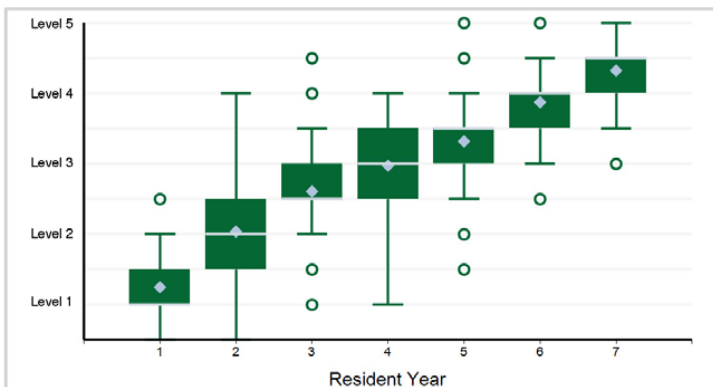

Note: 30 of 1,581 residents have a status of "Not Yet Rotated" and are not included in the analysis.

2. Patient Care - 2: Surgical Treatment of Epilepsy and Movement Disorders

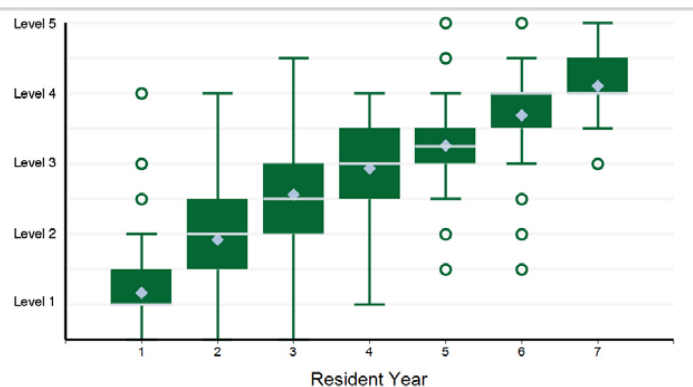

Note: 48 of 1,581 residents have a status of "Not Yet Rotated" and are not included in the analysis.

3. Patient Care - 3: Pain and Peripheral Nerve Disorders

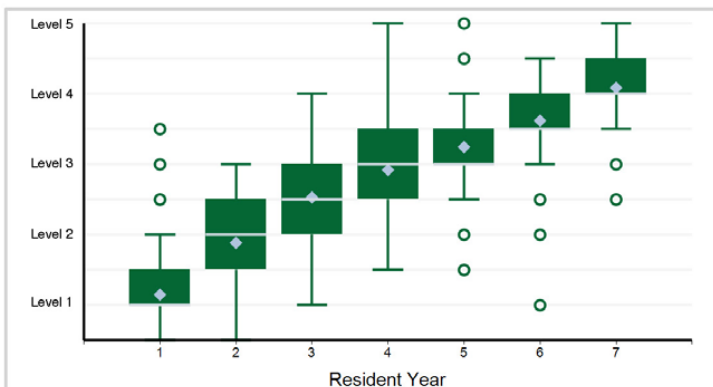

Note: 63 of 1,581 residents have a status of "Not Yet Rotated" and are not included in the analysis.

4. Patient Care - 4: Spinal Neurological Surgery

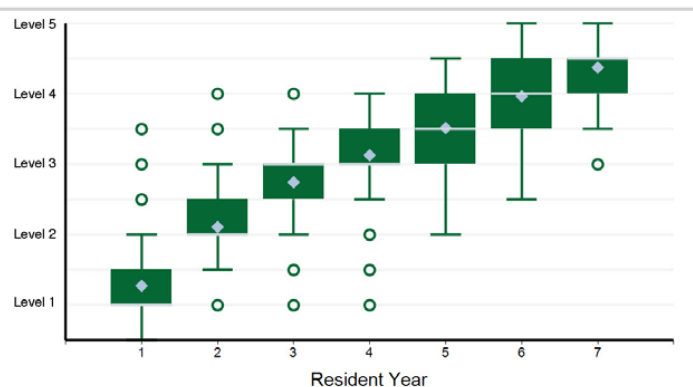

Note: 35 of 1,581 residents have a status of "Not Yet Rotated" and are not included in the analysis.

5. Patient Care - 5: Vascular Neurological Surgery

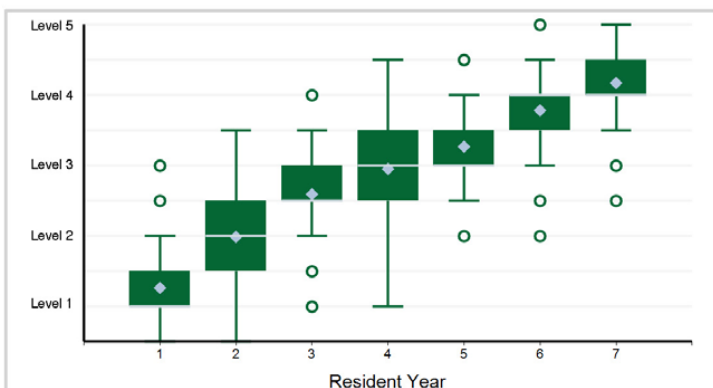

Note: 33 of 1,581 residents have a status of "Not Yet Rotated" and are not included in the analysis.

6. Patient Care - 6: Pediatric Neurological Surgery

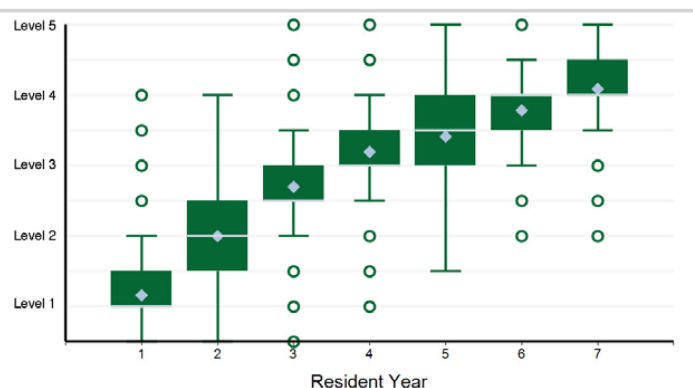

Note: 169 of 1,581 residents have a status of "Not Yet Rotated" and are not included in the analysis.

Specialty Box Plot Report - Milestone Evaluation by Resident Year: Year-End 2021-2022

SPECIALTY: Neurological Surgery

7. Patient Care - 7: Traumatic Brain Injury (TBI)

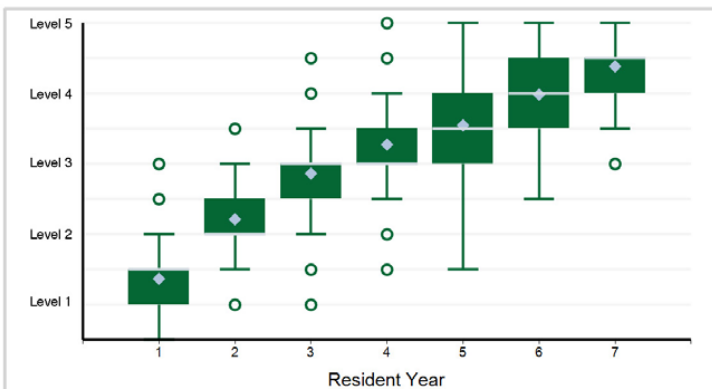

Note: 29 of 1,581 residents have a status of "Not Yet Rotated" and are not included in the analysis.

8. Patient Care - 8: Critical Care

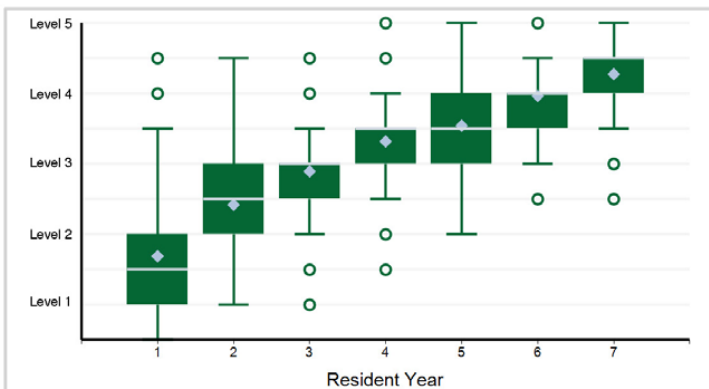

Note: 8 of 1,581 residents have a status of "Not Yet Rotated" and are not included in the analysis.

9. Medical Knowledge - 1: Information Gathering and Interpretation

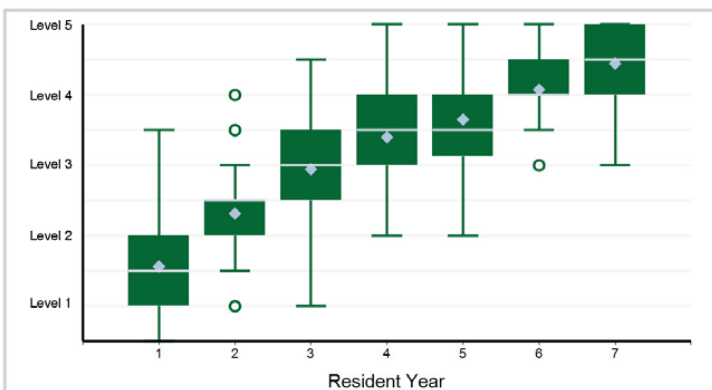

Note: 5 of 1,581 residents have a status of "Not Yet Rotated" and are not included in the analysis.

10. Medical Knowledge - 2: Critical Thinking for Diagnosis and Therapy

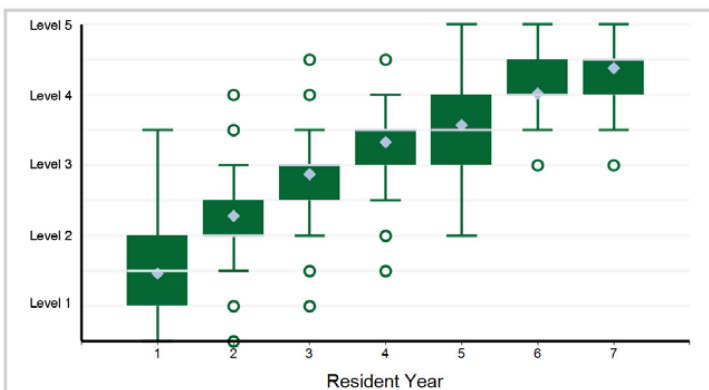

Note: 9 of 1,581 residents have a status of "Not Yet Rotated" and are not included in the analysis.

11. Systems-Based Practice - 1: Patient Safety

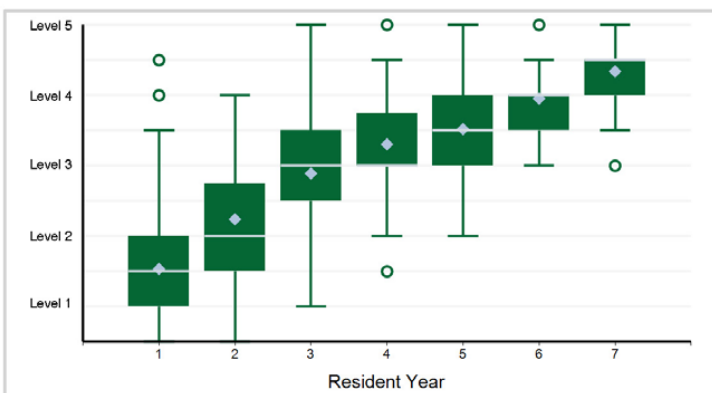

12. Systems-Based Practice - 2: Quality Improvement

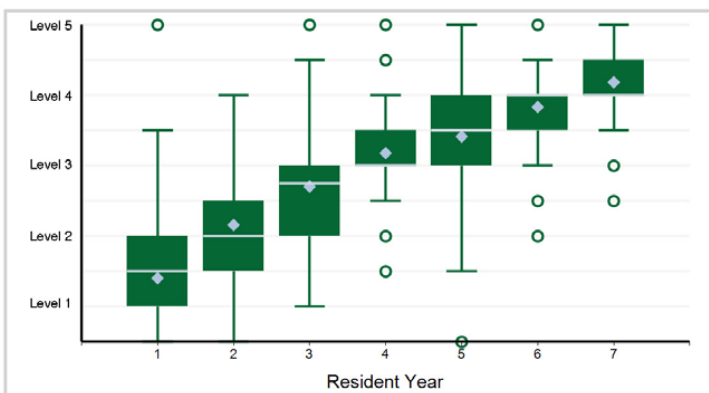

Specialty Box Plot Report - Milestone Evaluation by Resident Year: Year-End 2021-2022

SPECIALTY: Neurological Surgery

13. Systems-Based Practice - 3: Health Care Systems Awareness

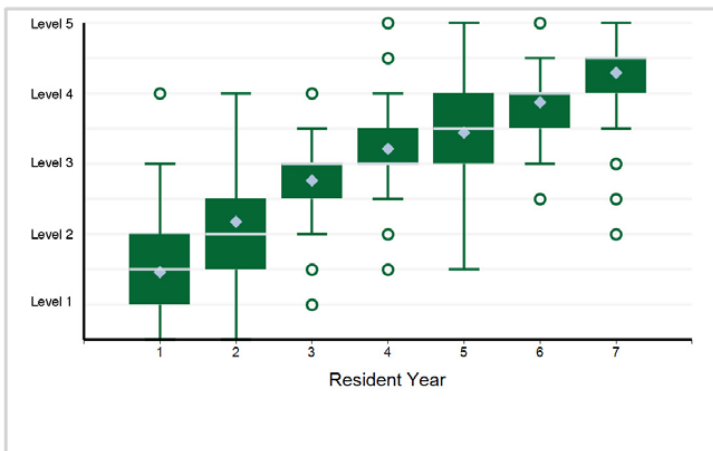

14. Practice-Based Learning and Improvement - 1: Evidence-Based Practice

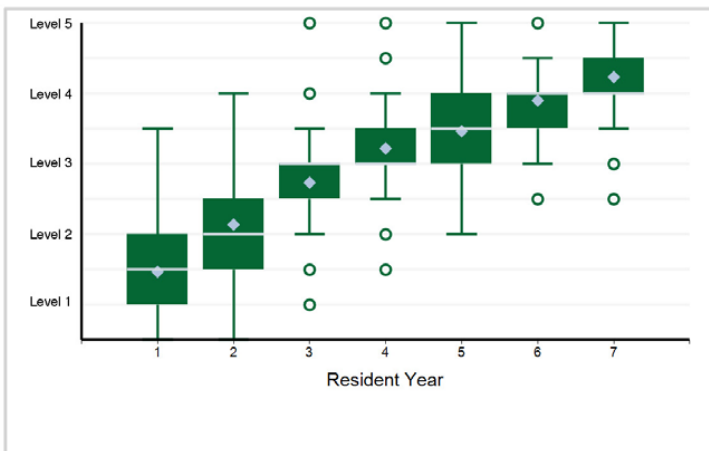

15. Practice-Based Learning and Improvement - 2: Research

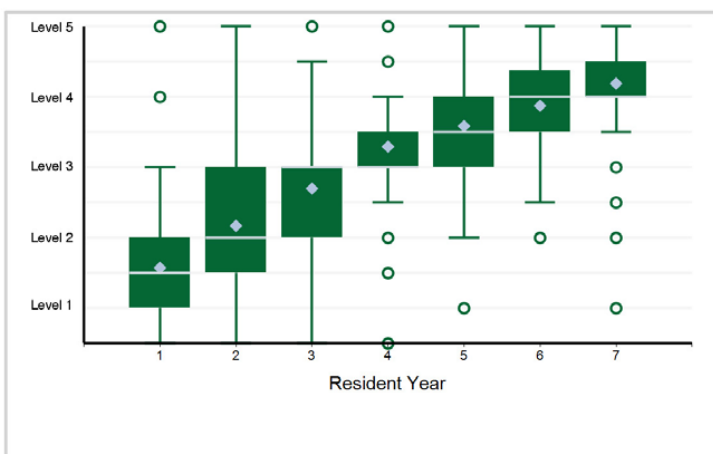

16. Practice-Based Learning and Improvement - 3: Mentorship and Teaching

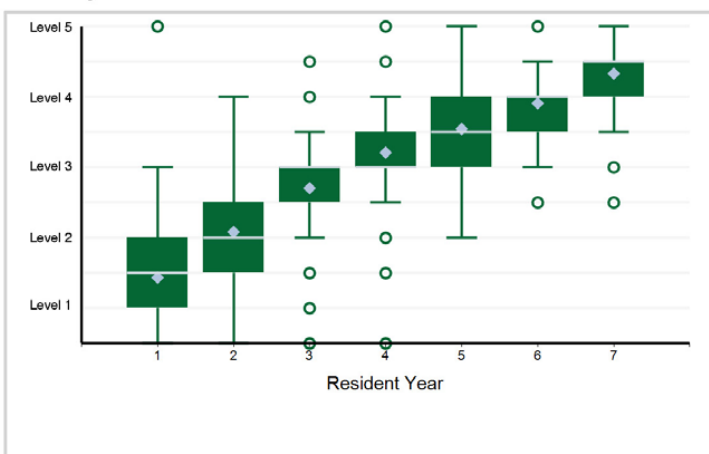

17. Professionalism - 1: Ethical Behavior

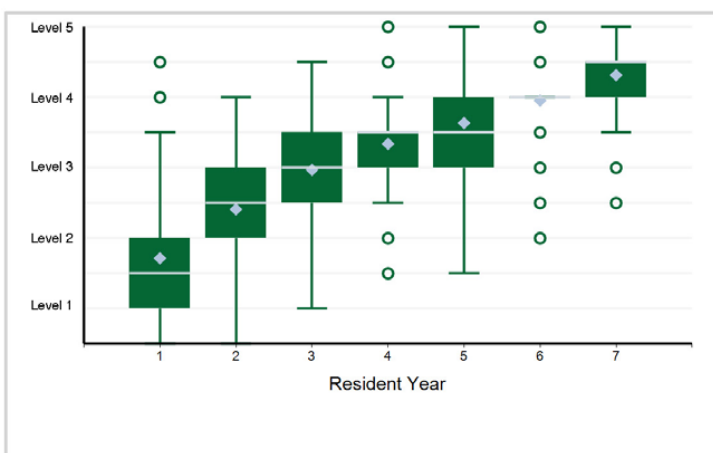

18. Professionalism - 2: Well-Being

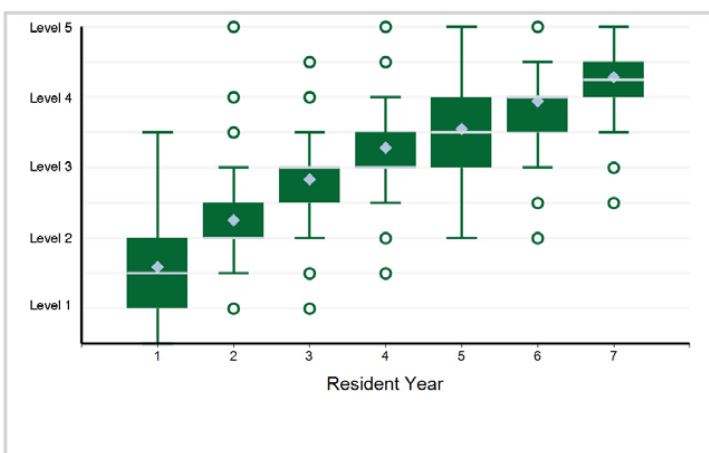

Specialty Box Plot Report - Milestone Evaluation by Resident Year: Year-End 2021-2022

SPECIALTY: Neurological Surgery

19. Interpersonal and Communication Skills - 1: Patient and Family Communication

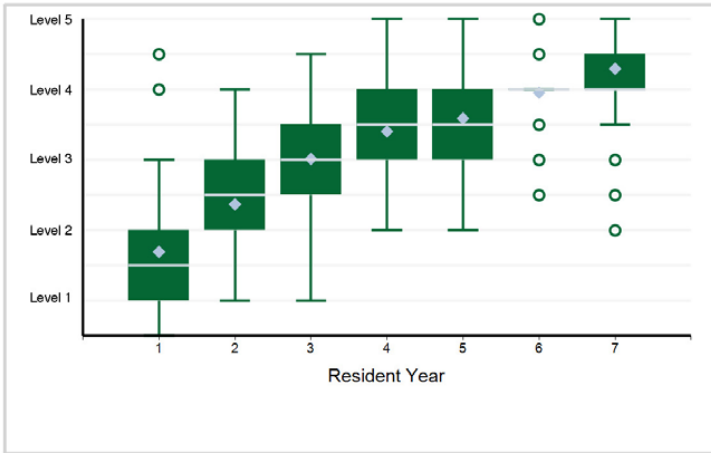

20. Interpersonal and Communication Skills - 2: Communication in Coordination of Care

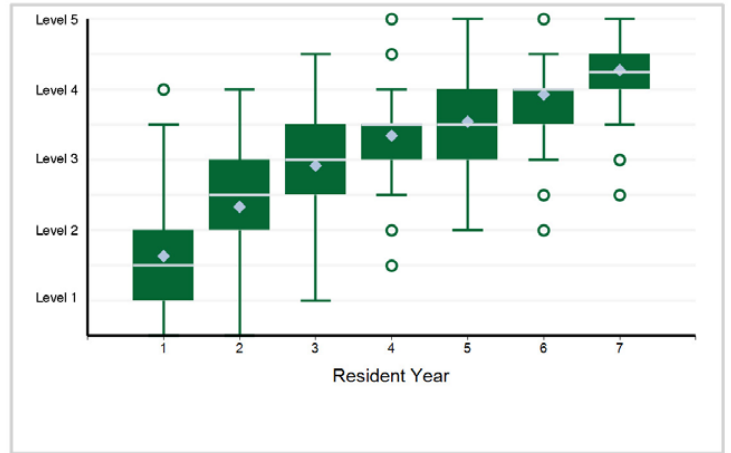

Specialty Box Plot Report - Milestone Evaluation by Resident Year: Year-End 2021-2022

TABLE 55: SPECIALTY: **Neurology**

Resident Year	1	2	3	4	Total Residents*
# of Residents	659	965	911	850	3,385

*Note: There are 5 residents with an incomplete milestone evaluation that are excluded from the box plots below.

1. Patient Care - Patient Care 1: History

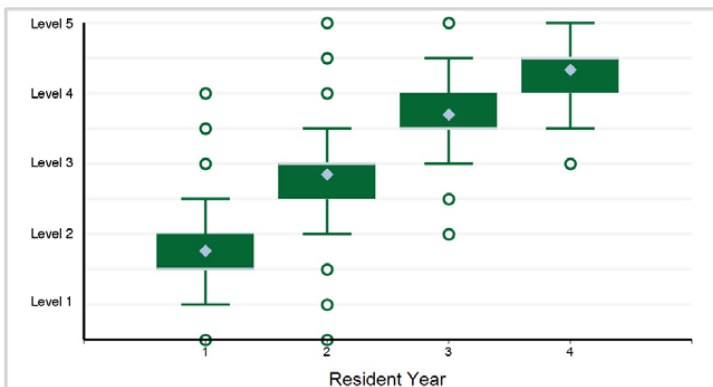

Note: 100 of 3,380 residents have a status of "Not Yet Assessable" and are not included in the analysis.

2. Patient Care - Patient Care 2: Neurologic Exam

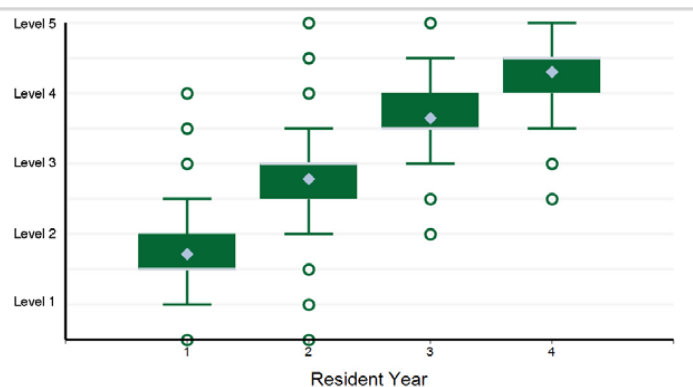

Note: 103 of 3,380 residents have a status of "Not Yet Assessable" and are not included in the analysis.

3. Patient Care - Patient Care 3: Formulation

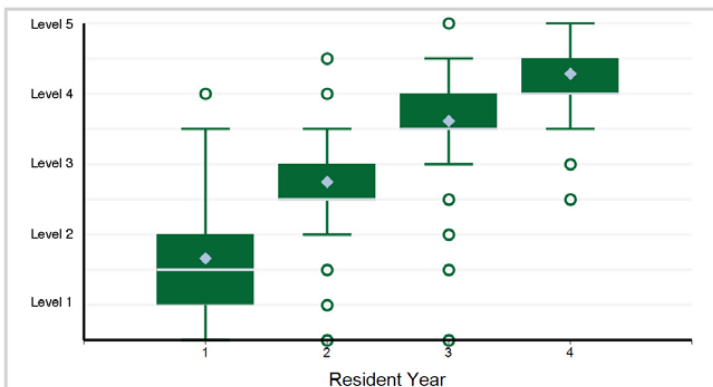

Note: 87 of 3,380 residents have a status of "Not Yet Assessable" and are not included in the analysis.

4. Patient Care - Patient Care 4: Diagnosis and Management of Neurologic Disorders in the Outpatient Setting

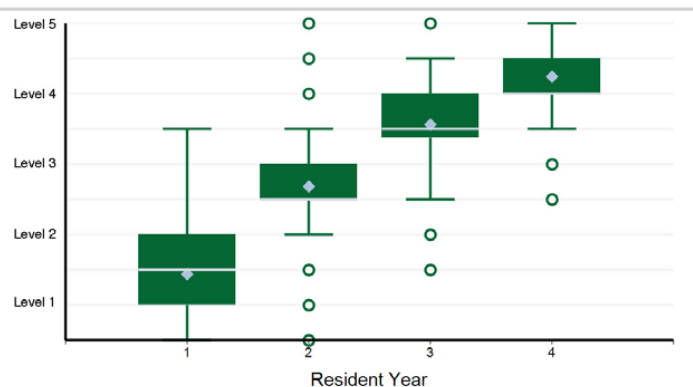

Note: 218 of 3,380 residents have a status of "Not Yet Assessable" and are not included in the analysis.

5. Patient Care - Patient Care 5: Diagnosis and Management of Neurologic Disorders in the Inpatient Setting

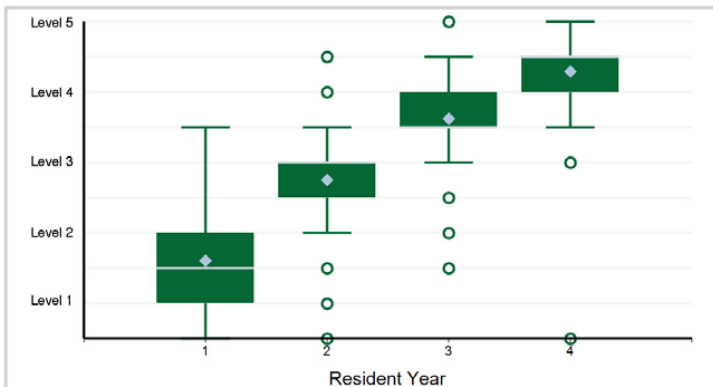

Note: 126 of 3,380 residents have a status of "Not Yet Assessable" and are not included in the analysis.

6. Patient Care - Patient Care 6: Diagnosis and Management of Neurologic Emergencies

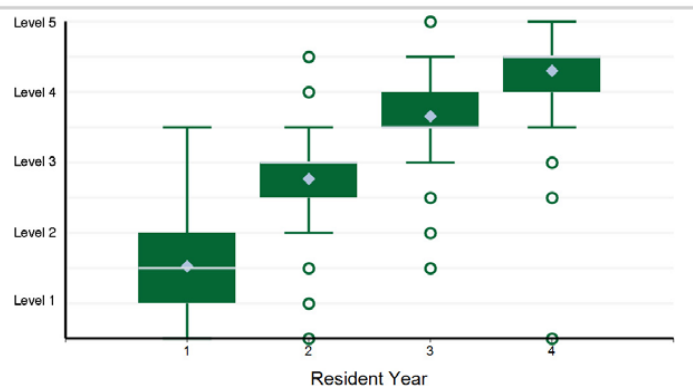

Note: 159 of 3,380 residents have a status of "Not Yet Assessable" and are not included in the analysis.

Specialty Box Plot Report - Milestone Evaluation by Resident Year: Year-End 2021-2022

SPECIALTY: Neurology

7. Patient Care - Patient Care 7: Determination of Death by Neurologic Criteria

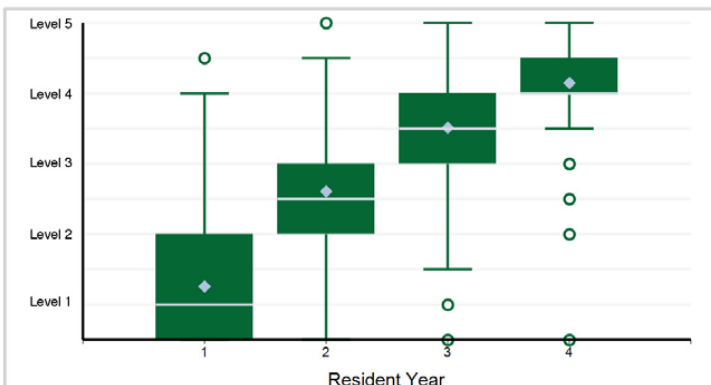

Note: 456 of 3,380 residents have a status of "Not Yet Assessable" and are not included in the analysis.

8. Patient Care - Patient Care 8: Interpretation of Neuroimaging

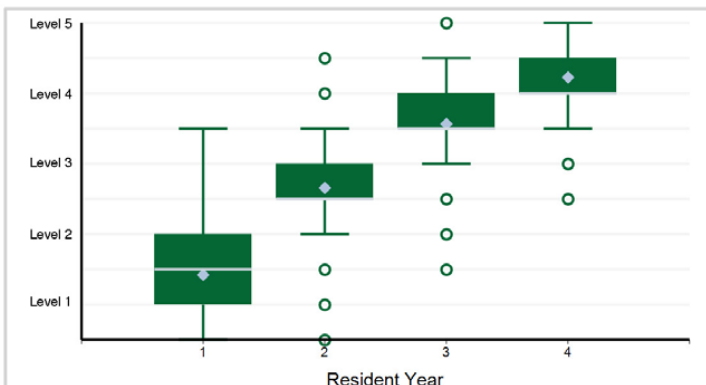

Note: 177 of 3,380 residents have a status of "Not Yet Assessable" and are not included in the analysis.

9. Patient Care - Patient Care 9: Electroencephalogram (EEG)

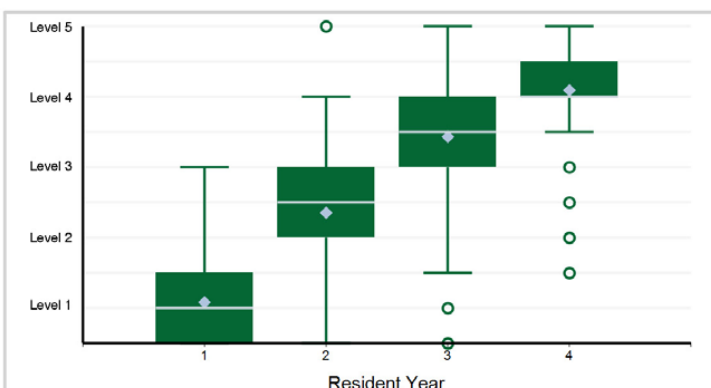

Note: 370 of 3,380 residents have a status of "Not Yet Assessable" and are not included in the analysis.

10. Patient Care - Patient Care 10: Nerve Conduction Study/Electromyogram (NCS/EMG)

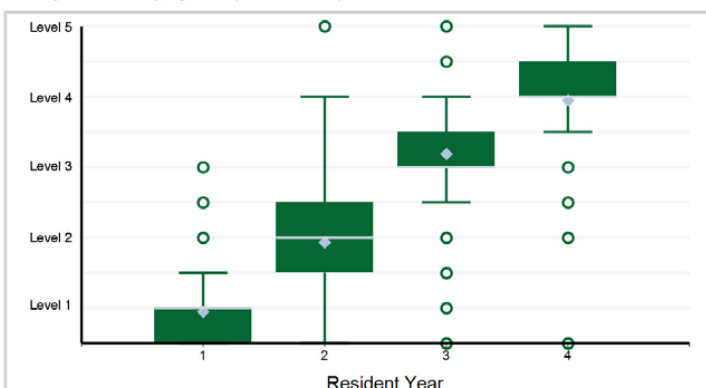

Note: 569 of 3,380 residents have a status of "Not Yet Assessable" and are not included in the analysis.

11. Patient Care - Patient Care 11: Lumbar Puncture

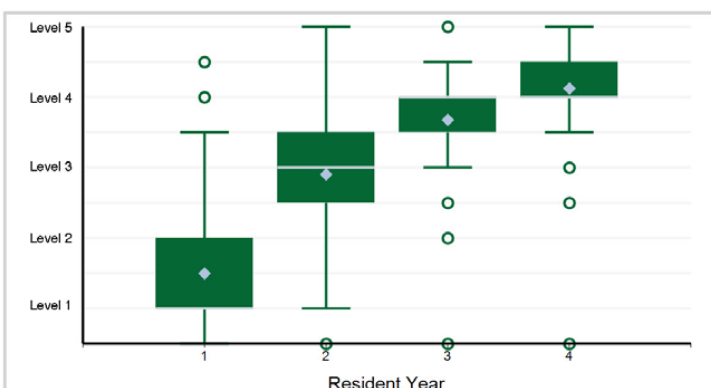

Note: 240 of 3,380 residents have a status of "Not Yet Assessable" and are not included in the analysis.

12. Patient Care - Patient Care 12: Psychiatric and Functional Aspects of Neurology

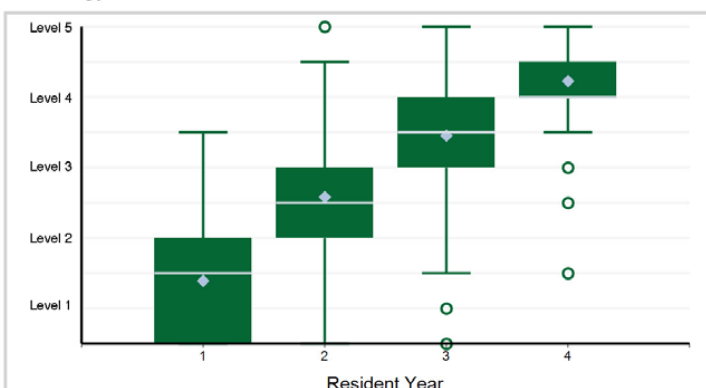

Note: 357 of 3,380 residents have a status of "Not Yet Assessable" and are not included in the analysis.

Specialty Box Plot Report - Milestone Evaluation by Resident Year: Year-End 2021-2022

SPECIALTY: **Neurology**

13. Medical Knowledge - Medical Knowledge 1: Localization

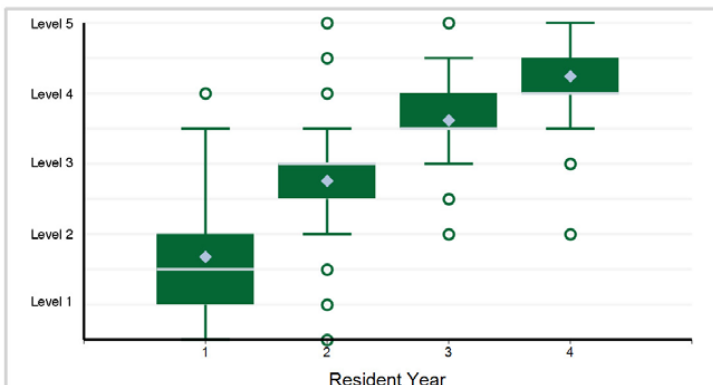

Note: 84 of 3,380 residents have a status of "Not Yet Assessable" and are not included in the analysis.

14. Medical Knowledge - Medical Knowledge 2: Diagnostic Investigation

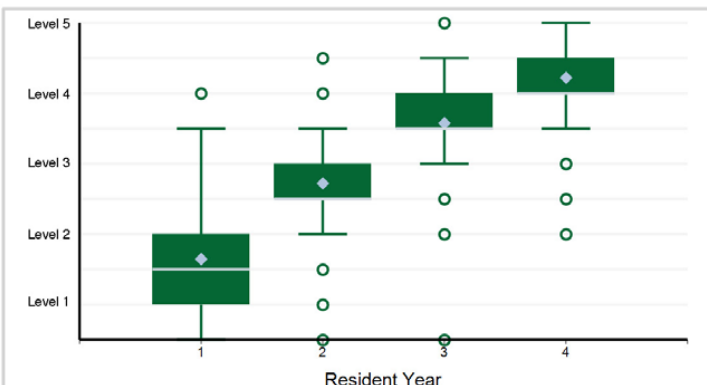

Note: 92 of 3,380 residents have a status of "Not Yet Assessable" and are not included in the analysis.

15. Systems-Based Practice - Systems-Based Practice 1: Patient Safety

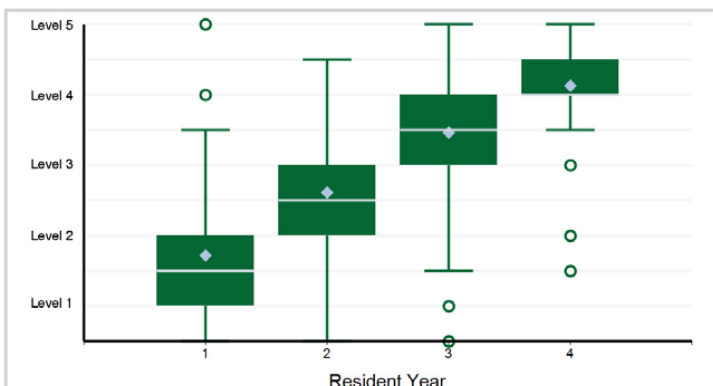

16. Systems-Based Practice - Systems-Based Practice 2: Quality Improvement

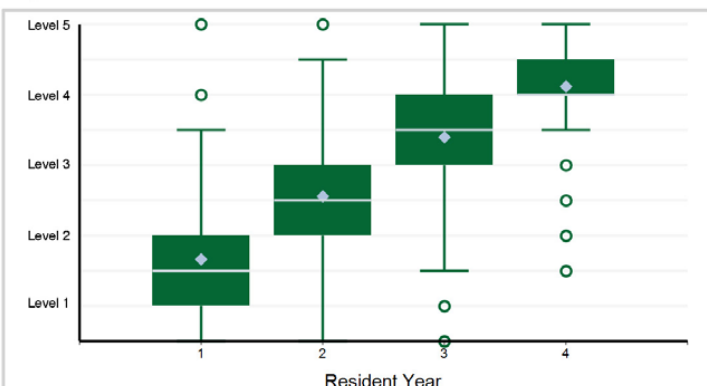

17. Systems-Based Practice - Systems-Based Practice 3: System Navigation for Patient-Centered Care

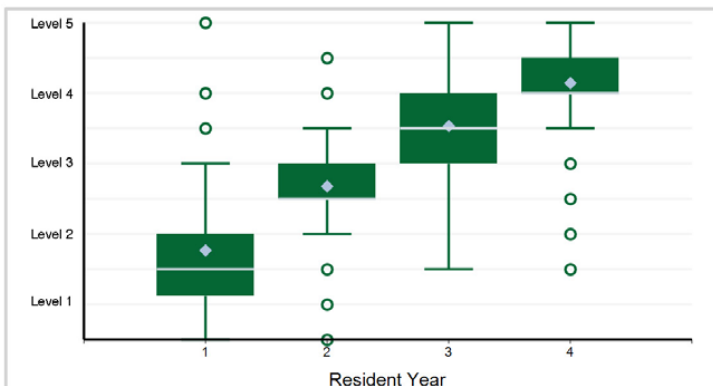

18. Systems-Based Practice - Systems-Based Practice 4: Physician Role in Health Care Systems

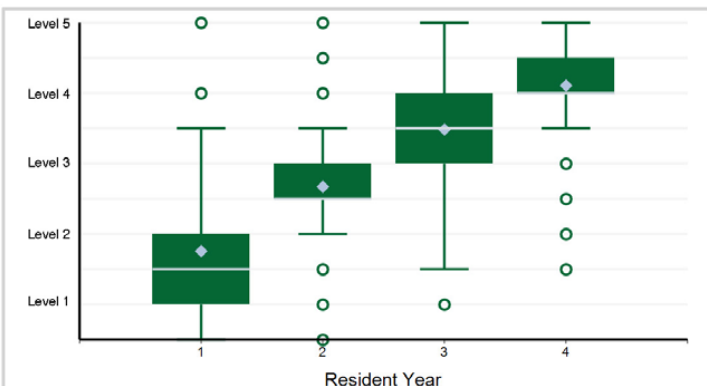

Specialty Box Plot Report - Milestone Evaluation by Resident Year: Year-End 2021-2022

SPECIALTY: Neurology

19. Practice-Based Learning and Improvement - Practice-Based Learning and Improvement 1: Evidence-Based and Informed Practice

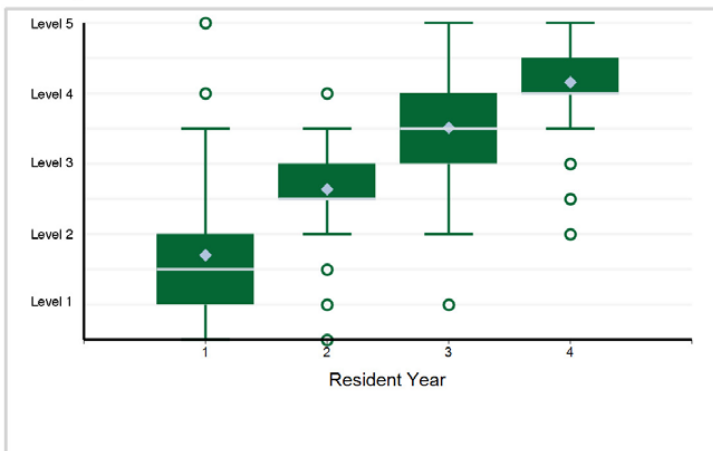

20. Practice-Based Learning and Improvement - Practice-Based Learning and Improvement 2: Reflective Practice and Commitment ...

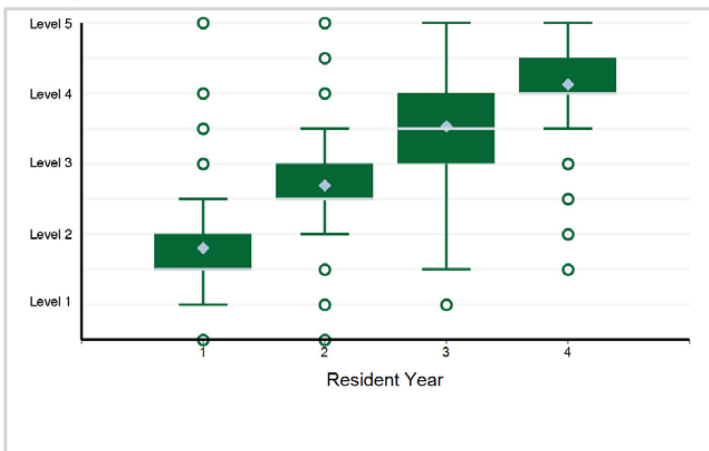

21. Professionalism - Professionalism 1: Professional Behavior and Ethical Principles

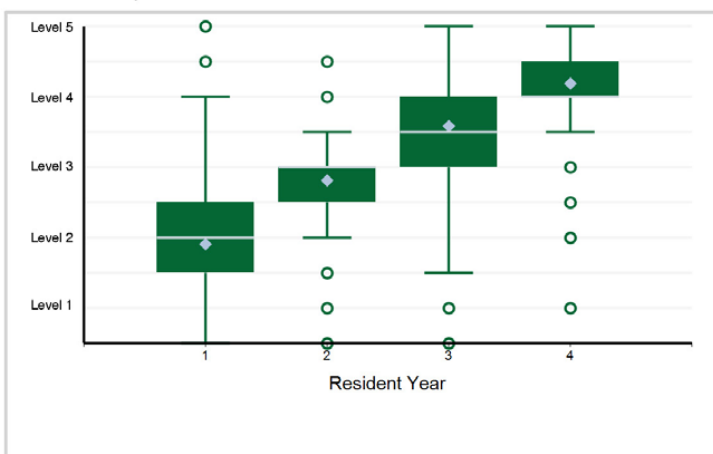

22. Professionalism - Professionalism 2: Accountability/Conscientiousness

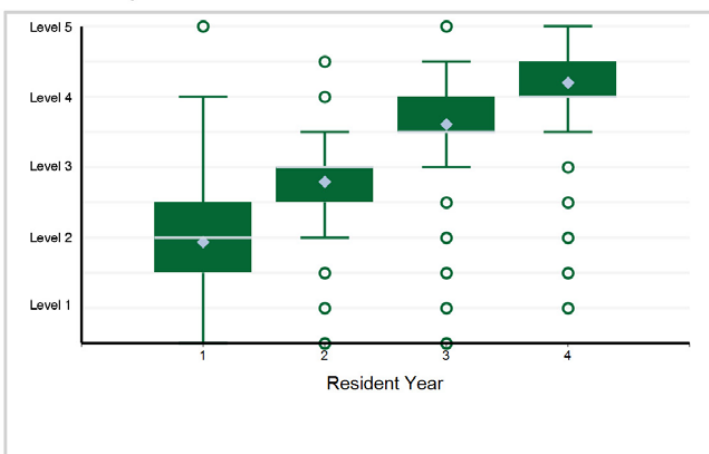

23. Professionalism - Professionalism 3: Well-Being

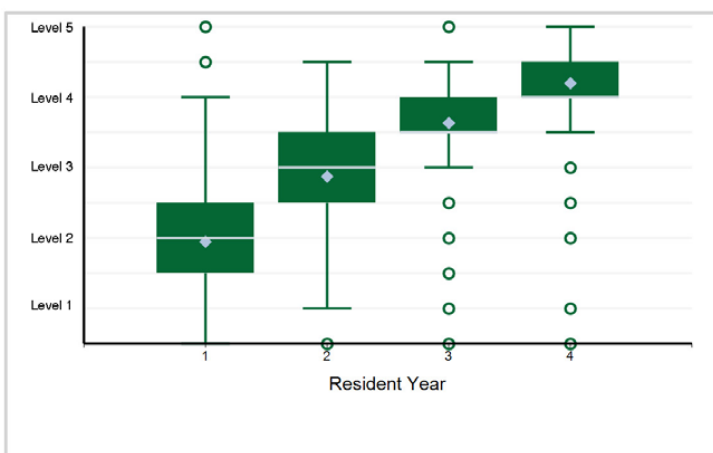

24. Interpersonal and Communication Skills - Interpersonal and Communication Skills 1: Patient- and Family-Centered Communication

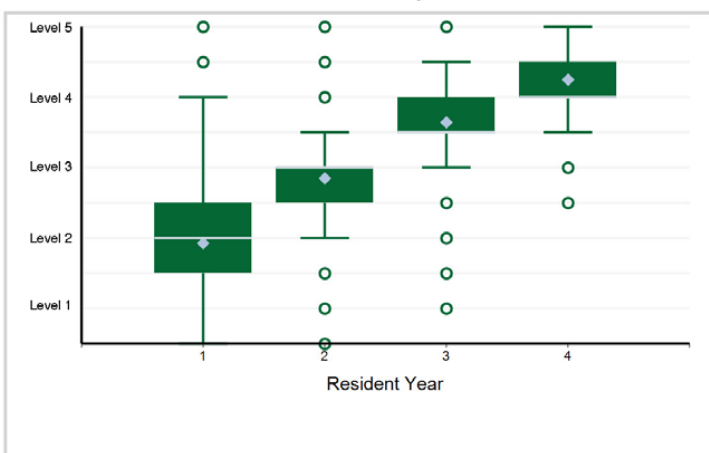

Specialty Box Plot Report - Milestone Evaluation by Resident Year: Year-End 2021-2022

SPECIALTY: **Neurology**

25. Interpersonal and Communication Skills - Interpersonal and Communication Skills 2: Barrier and Bias Mitigation

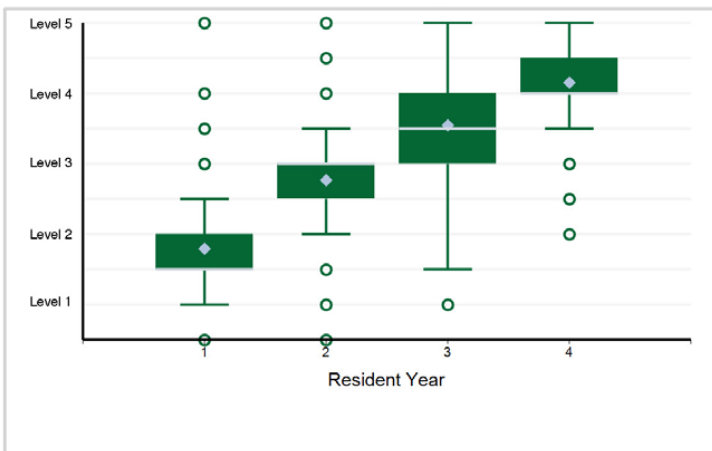

26. Interpersonal and Communication Skills - Interpersonal and Communication Skills 3: Interprofessional and Team Communication

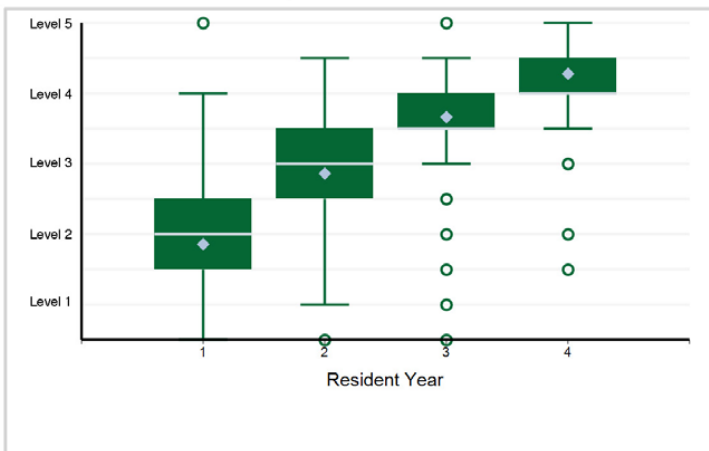

27. Interpersonal and Communication Skills - Interpersonal and Communication Skills 4: Communication within Health Care Systems

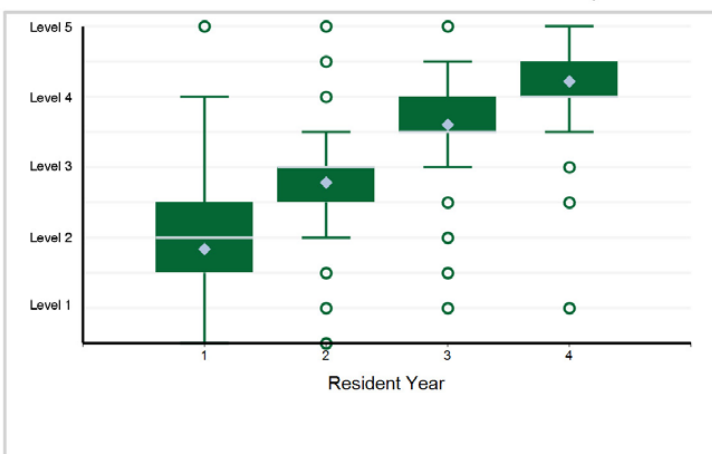

Specialty Box Plot Report - Milestone Evaluation by Resident Year: Year-End 2021-2022

TABLE 56: SUBSPECIALTY: **Clinical Neurophysiology**

Resident Year	1	Total Residents*
# of Residents	154	154

*Note: There are 1 residents with an incomplete milestone evaluation that are excluded from the box plots below.

1. Patient Care - History — Patient Care

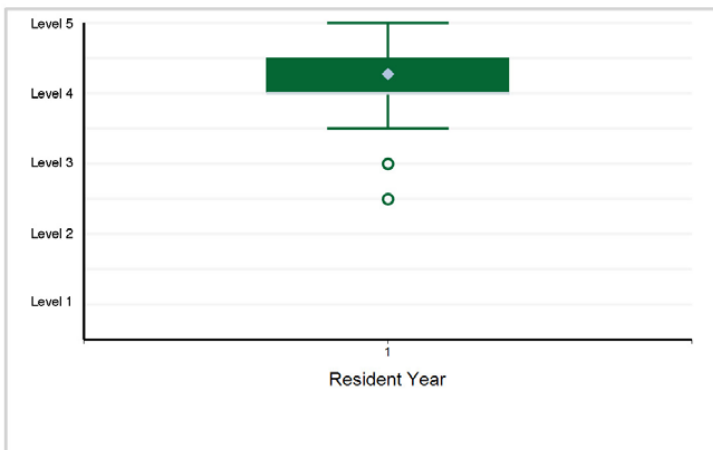

2. Patient Care - Neurological Exam — Patient Care

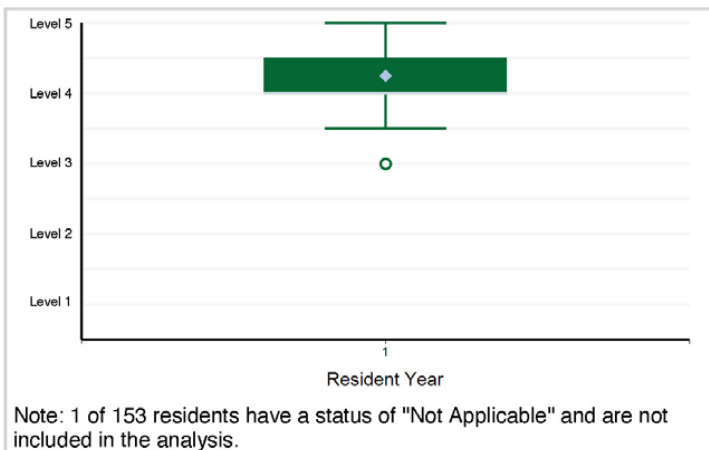

3. Patient Care - Electroencephalogram (EEG) — Patient Care

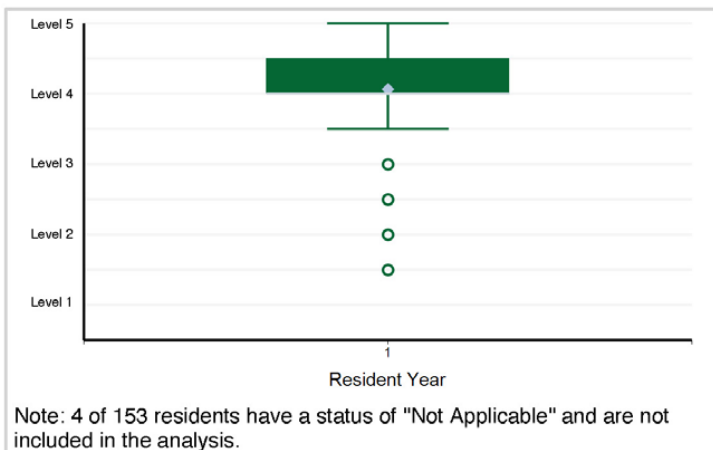

4. Patient Care - Nerve Conduction Studies (NCS) — Patient Care

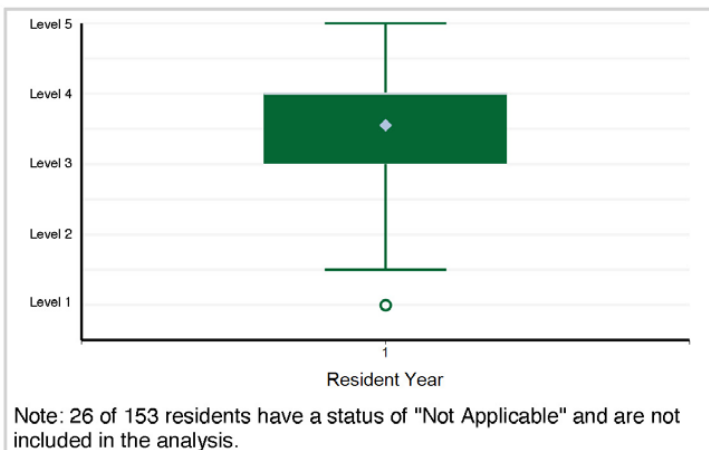

5. Patient Care - EMG — Patient Care

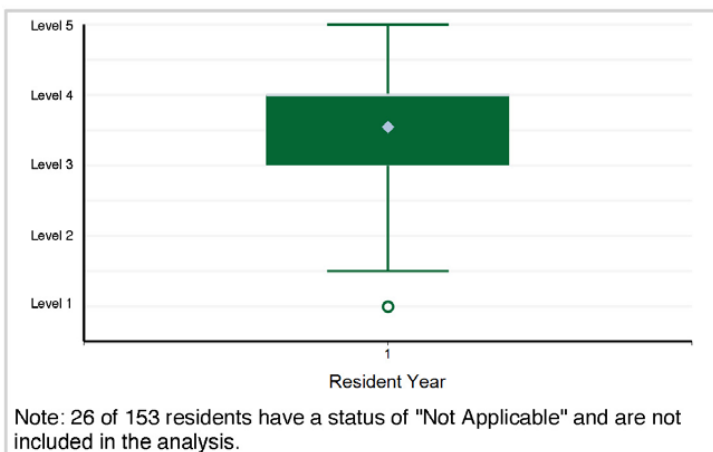

6. Patient Care - Evoked Potential (EP)/Intraoperative Monitoring (IOM) — Patient Care

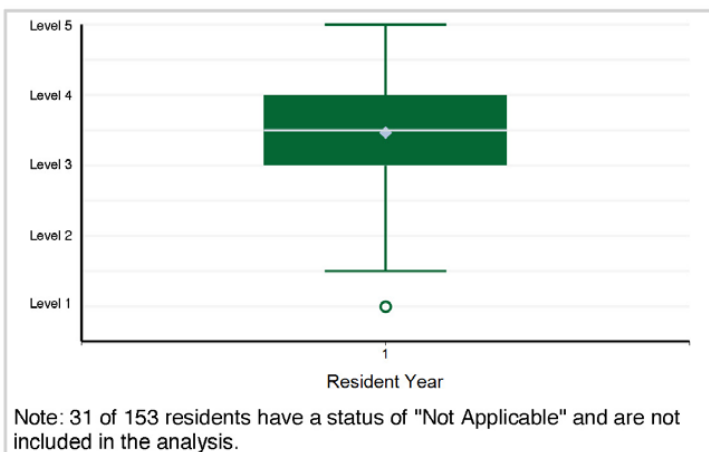

Specialty Box Plot Report - Milestone Evaluation by Resident Year: Year-End 2021-2022

SUBSPECIALTY: Clinical Neurophysiology

7. Patient Care - Sleep Disorders — Patient Care

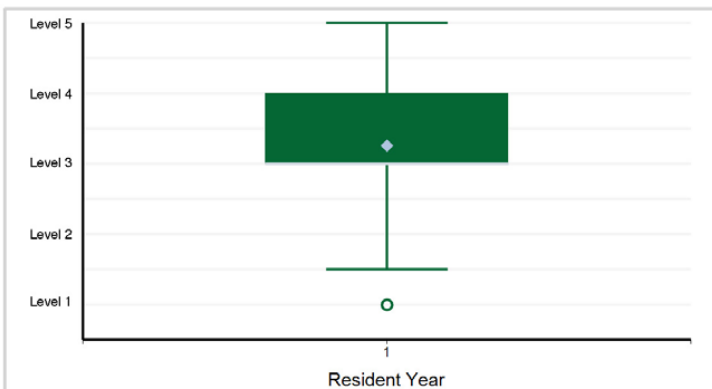

Note: 64 of 153 residents have a status of "Not Applicable" and are not included in the analysis.

8. Medical Knowledge - Localization — Medical Knowledge

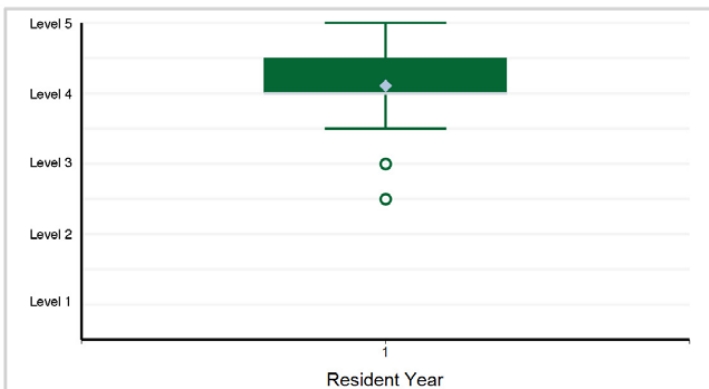

9. Medical Knowledge - Planning Neurophysiologic Testing — Medical Knowledge

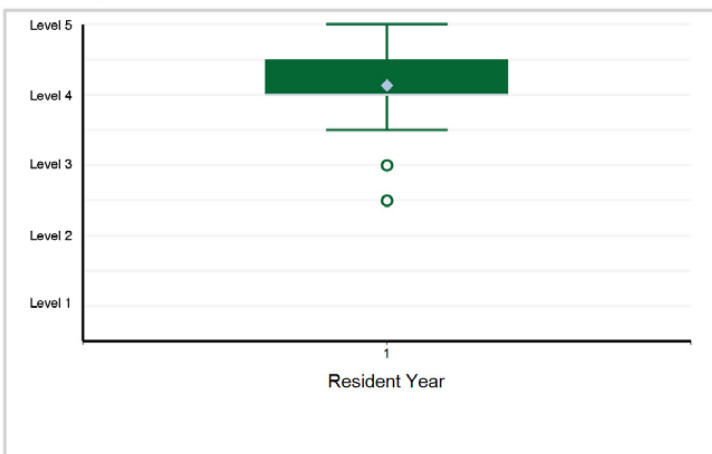

10. Medical Knowledge - Neuromuscular Disorders — Medical Knowledge

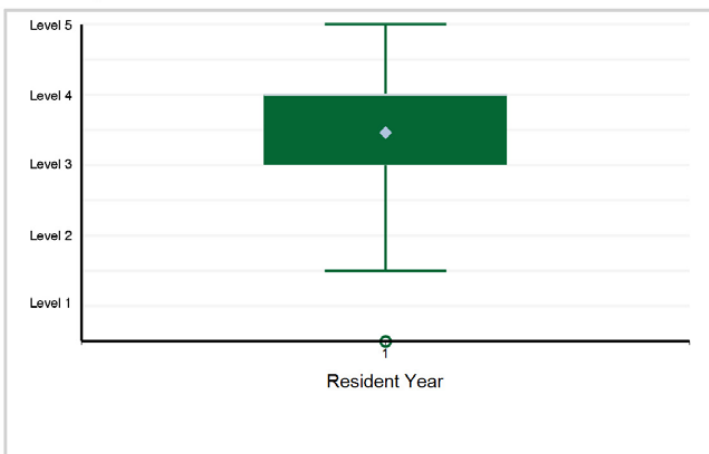

11. Medical Knowledge - Epilepsy — Medical Knowledge

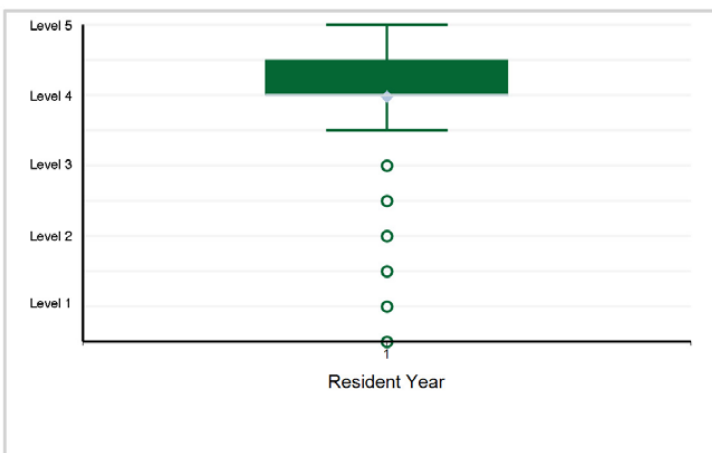

12. Medical Knowledge - Sleep Disorders — Medical Knowledge

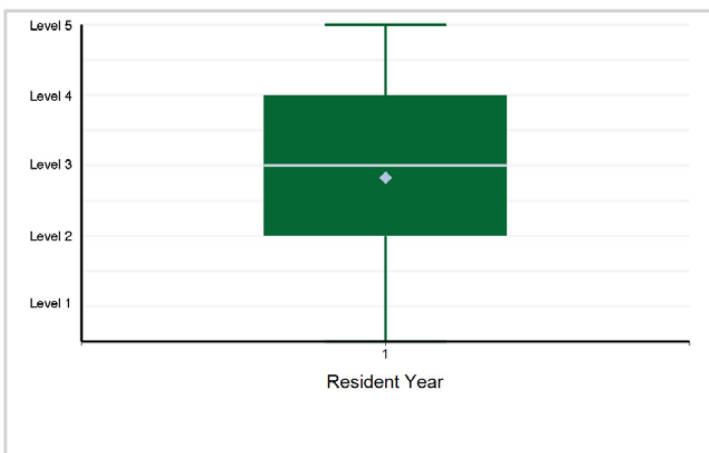

Specialty Box Plot Report - Milestone Evaluation by Resident Year: Year-End 2021-2022

SUBSPECIALTY: Clinical Neurophysiology

13. Medical Knowledge - EP/IOM — Medical Knowledge

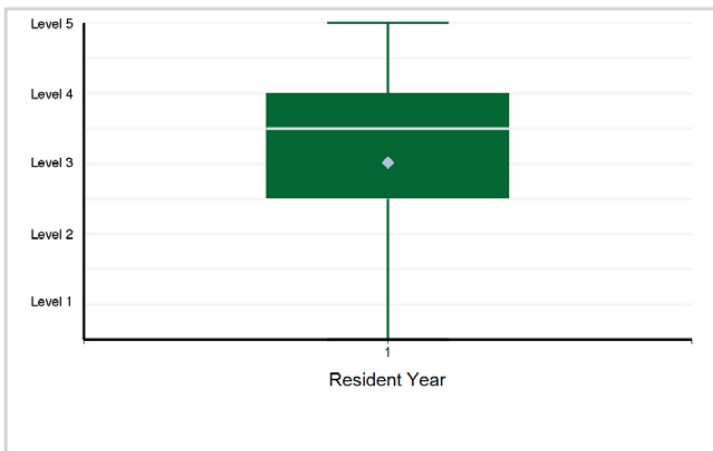

14. Systems-Based Practice - Systems thinking, including cost- and risk-effective practice — Systems-Based Practice

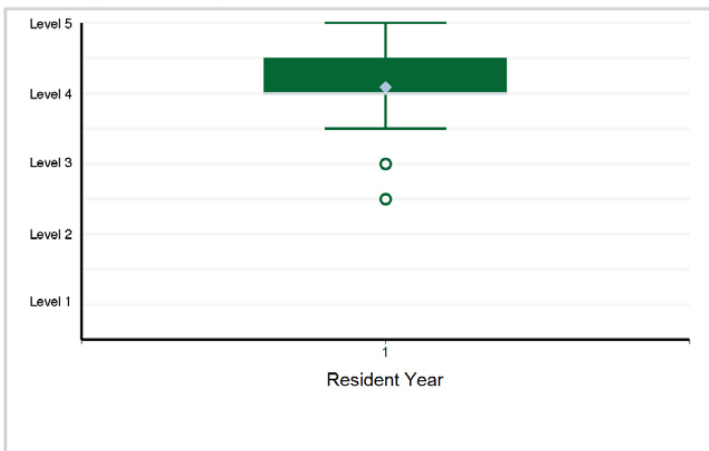

15. Systems-Based Practice - Work in interprofessional teams to enhance patient safety — Systems-Based Practice

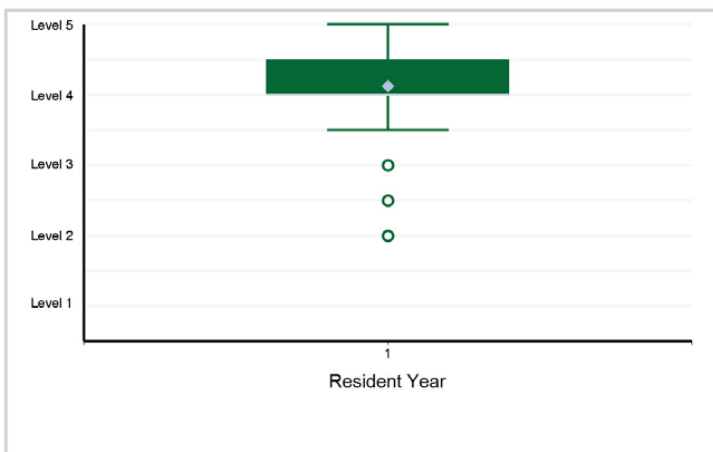

16. Practice-Based Learning and Improvement - Self-directed learning — Practice-Based Learning and Improvement • Identify ...

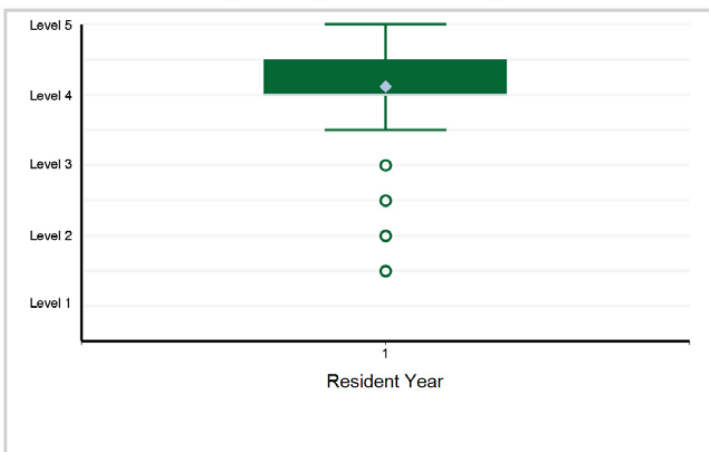

17. Practice-Based Learning and Improvement - Locate, appraise, and assimilate evidence from scientific ...

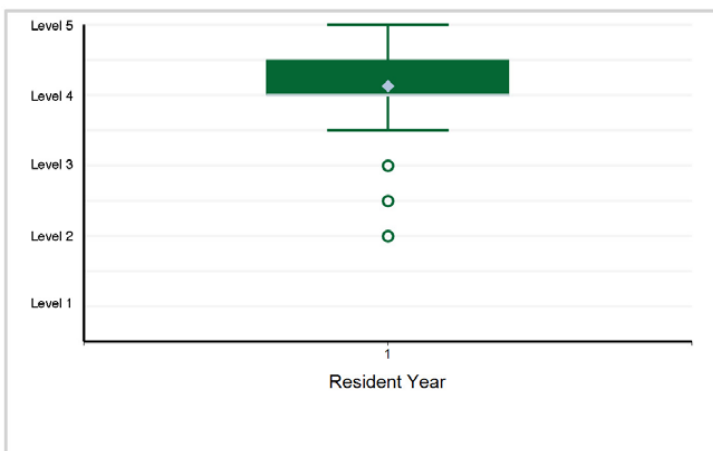

18. Professionalism - Compassion, integrity, accountability, and respect for self and others — Professionalism

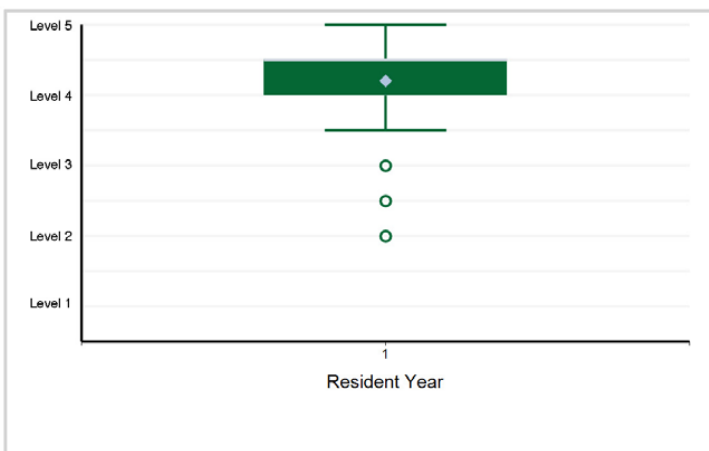

Specialty Box Plot Report - Milestone Evaluation by Resident Year: Year-End 2021-2022

SUBSPECIALTY: Clinical Neurophysiology

19. Professionalism - Knowledge about, respect for, and adherence to the ethical principles relevant to ...

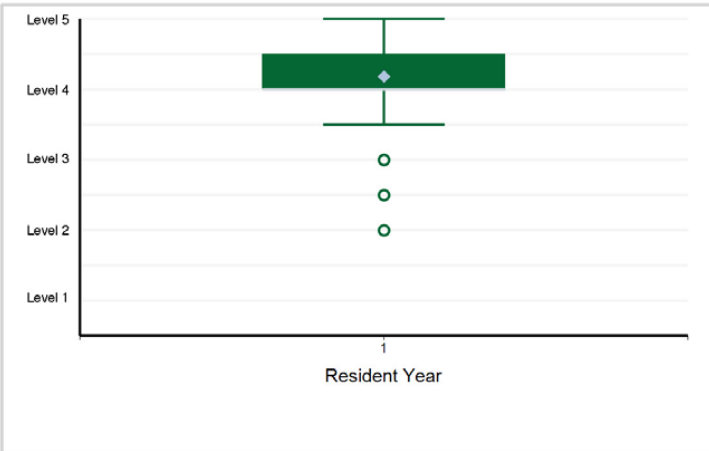

20. Interpersonal and Communication Skills - Relationship development, teamwork, and managing conflict — ...

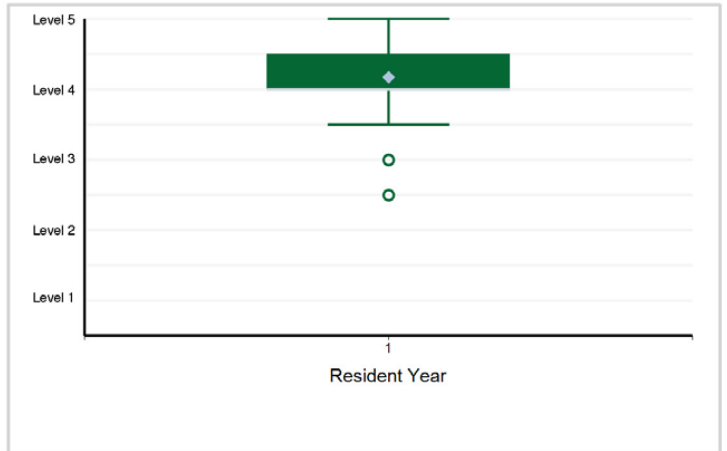

21. Interpersonal and Communication Skills - Information sharing, gathering, and technology — Interpersonal ...

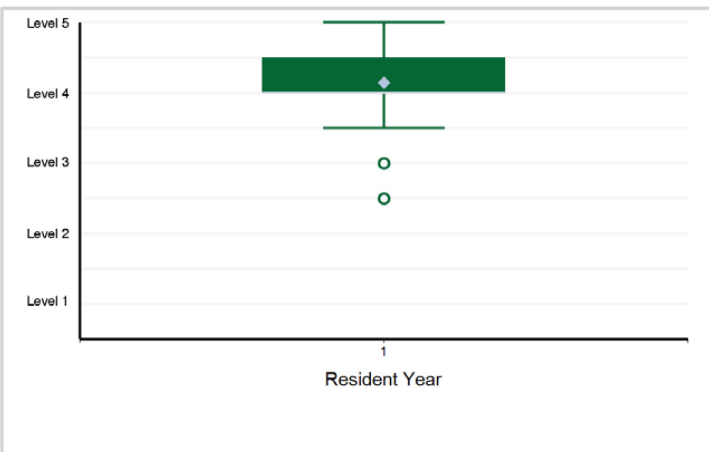

Specialty Box Plot Report - Milestone Evaluation by Resident Year: Year-End 2021-2022

TABLE 57: SUBSPECIALTY: **Epilepsy**

Resident Year	1	Total Residents
# of Residents	158	158

1. Patient Care - History — Patient Care

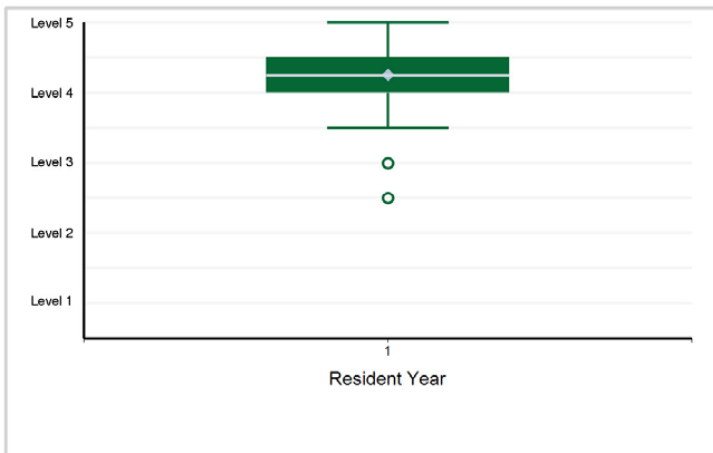

2. Patient Care - Neurological Examination — Patient Care

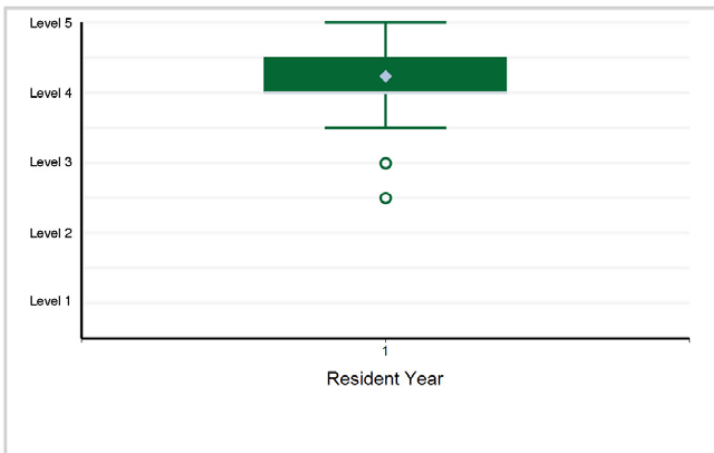

3. Patient Care - Medical Management — Patient Care

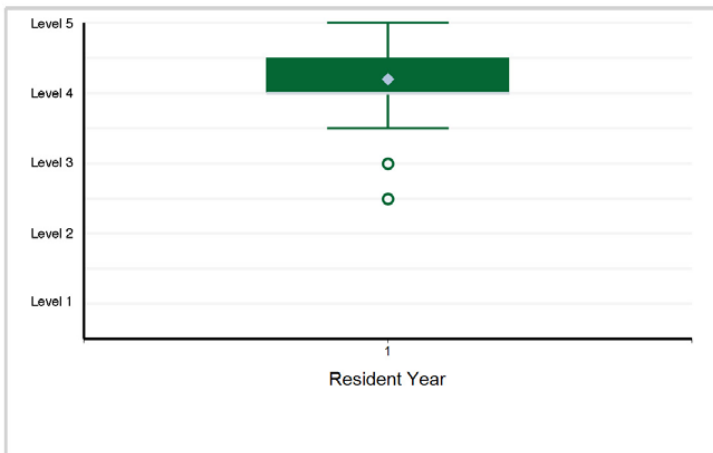

4. Patient Care - Surgical Management — Patient Care

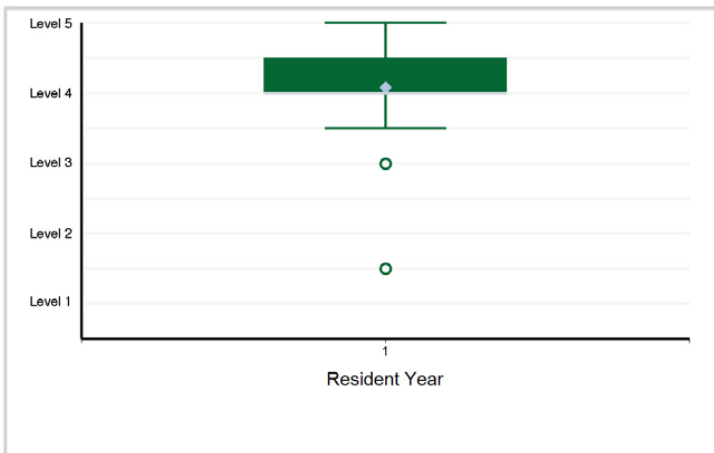

5. Patient Care - Emergent and Critical Care Management — Patient Care

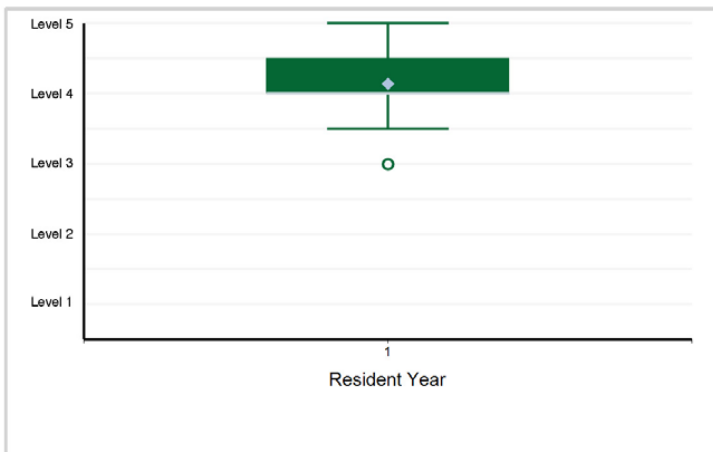

6. Patient Care - Cognitive, Behavioral, and Psychiatric Disorders Associated with Seizure Disorders — Patient Care

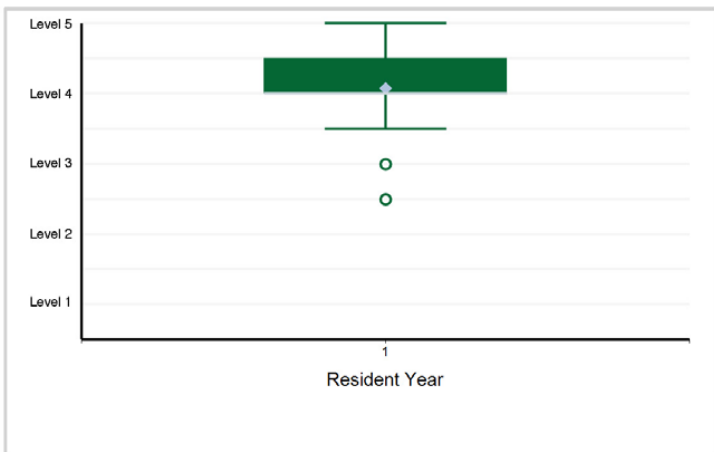

Specialty Box Plot Report - Milestone Evaluation by Resident Year: Year-End 2021-2022

SUBSPECIALTY: **Epilepsy**

7. Medical Knowledge - Epilepsy Localization — Medical Knowledge

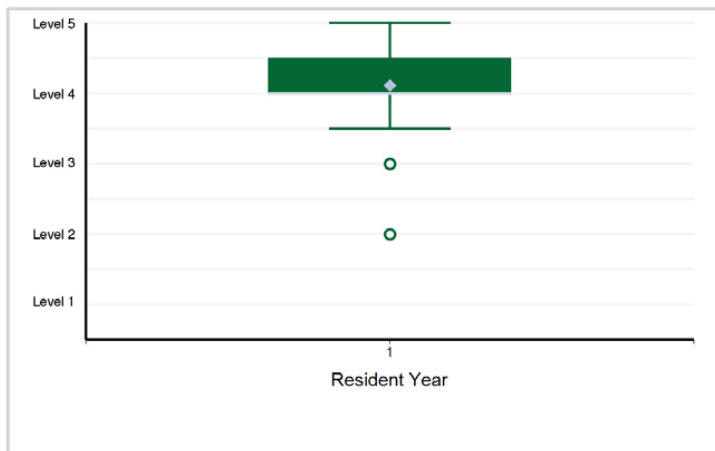

8. Medical Knowledge - Diagnostic Investigation — Medical Knowledge

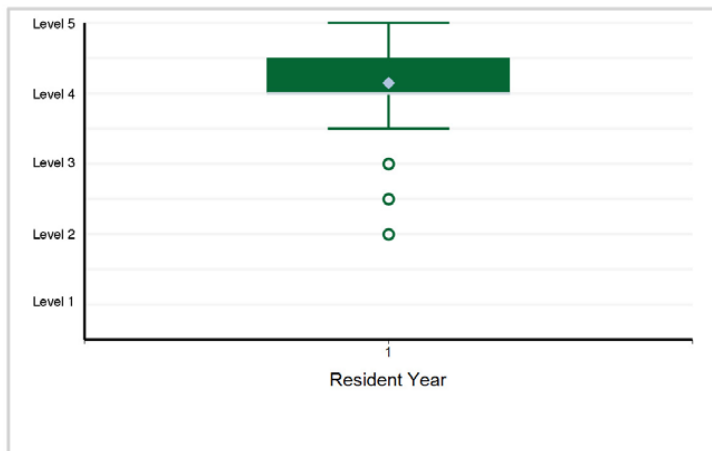

9. Medical Knowledge - Seizure and Epilepsy Classification — Medical Knowledge



10. Systems-Based Practice - Work in Interprofessional Teams to Enhance Patient Safety — Systems-Based Practice

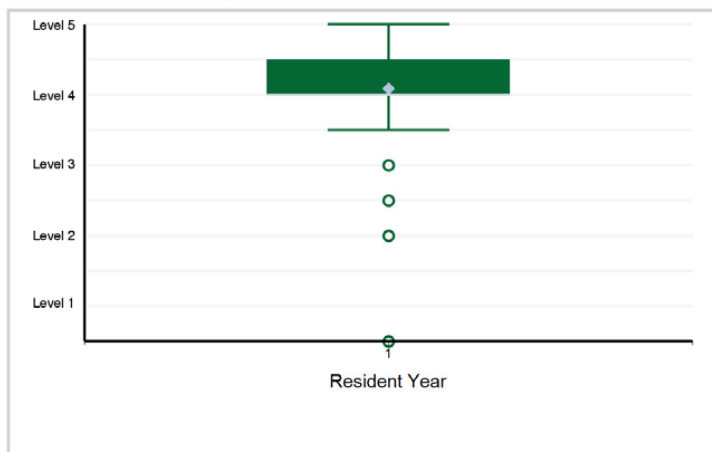

11. Systems-Based Practice - Systems Thinking, Including Cost- and Risk-Effective Practice — Systems-Based Practice

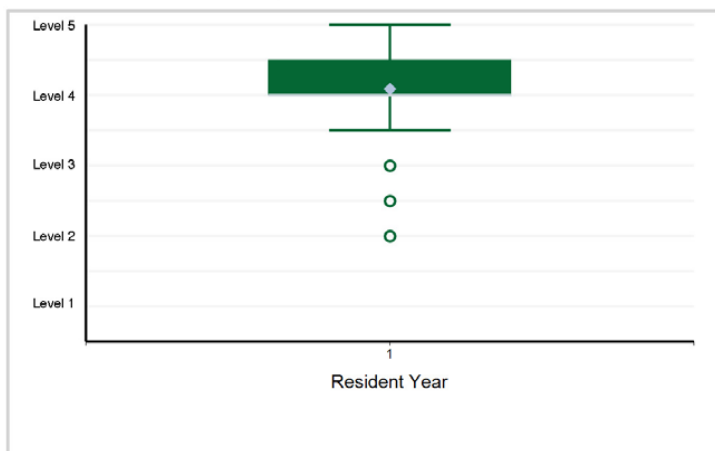

12. Systems-Based Practice - Advocacy, Continuum of Care, and Community Resources — Systems-Based Practice

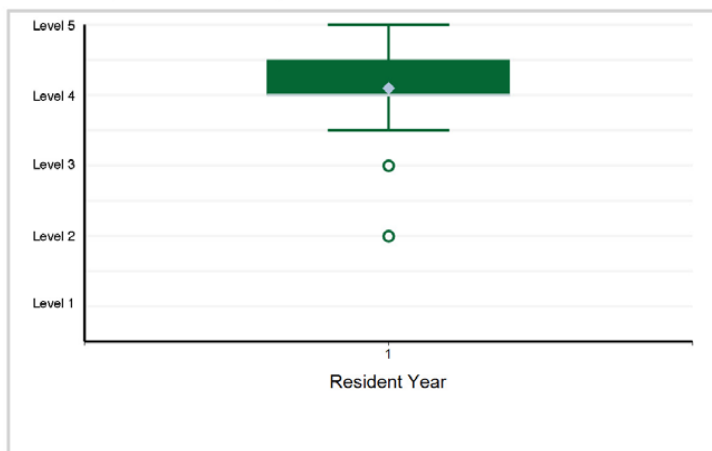

Specialty Box Plot Report - Milestone Evaluation by Resident Year: Year-End 2021-2022

SUBSPECIALTY: Epilepsy

13. Practice-Based Learning and Improvement - Self-directed learning — Practice-Based Learning and Improvement ...

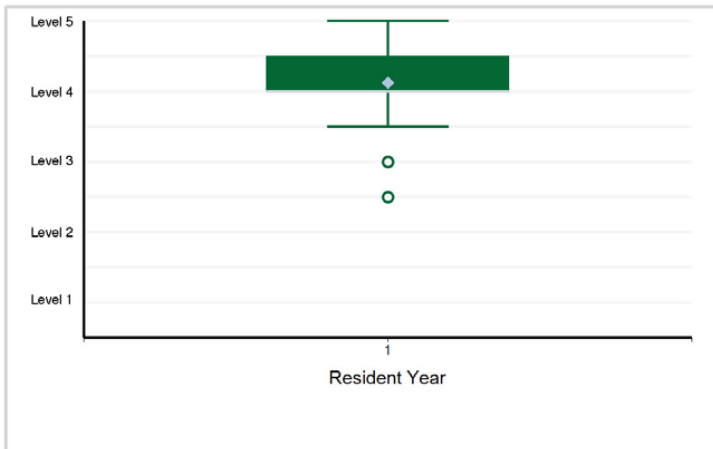

14. Practice-Based Learning and Improvement - Locate, Appraise, and Assimilate Evidence from Scientific ...

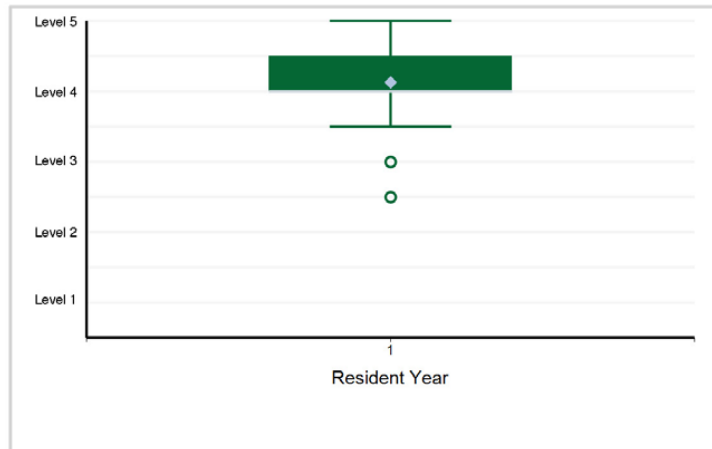

15. Professionalism - Compassion, Integrity, Accountability, and Respect for Self and Others — Professionalism

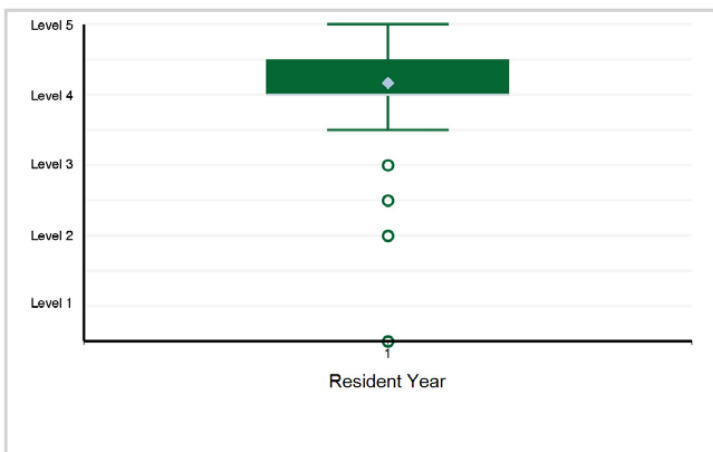

16. Professionalism - Knowledge about, Respect for, and Adherence to the Ethical Principles Relevant to ...

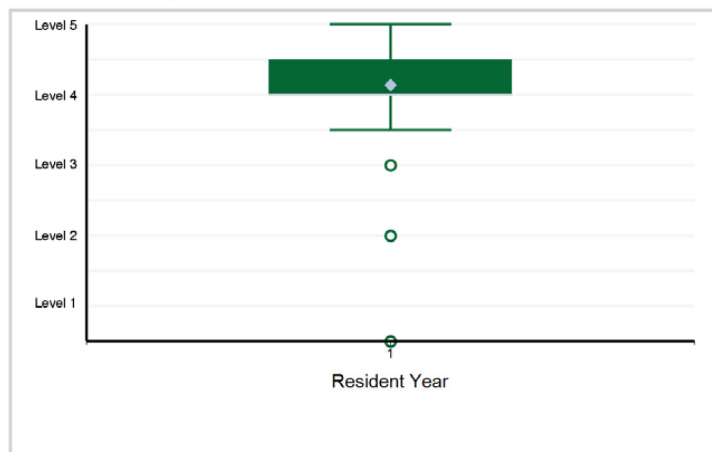

17. Interpersonal and Communication Skills - Relationship Development, Teamwork, and Managing Conflict — ...

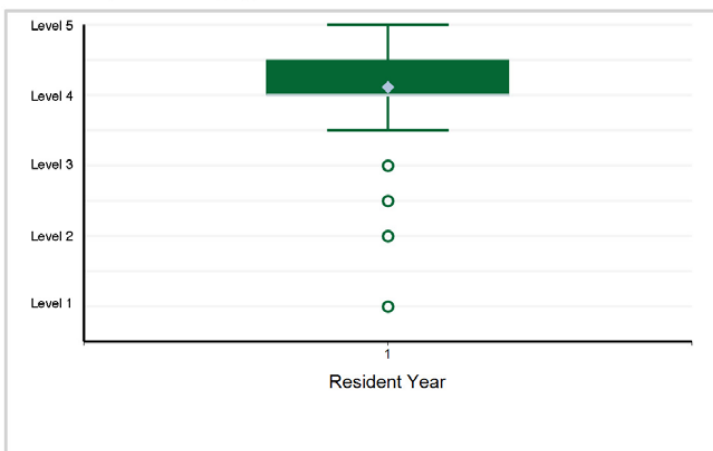

18. Interpersonal and Communication Skills - Information Sharing, Gathering, and Technology — Interpersonal ...

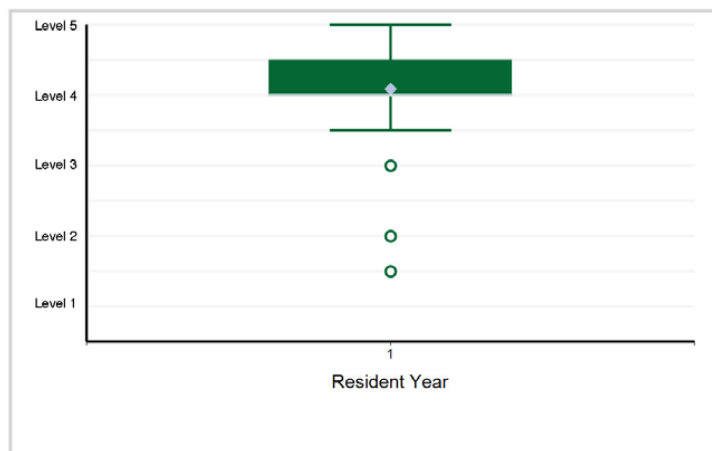

Specialty Box Plot Report - Milestone Evaluation by Resident Year: Year-End 2021-2022

TABLE 58: SUBSPECIALTY: **Neurodevelopmental Disabilities**

Resident Year	1	2	3	4	Total Residents
# of Residents	7	8	7	5	27

1. Patient Care - Patient Care 1: Neurologic and Developmental History

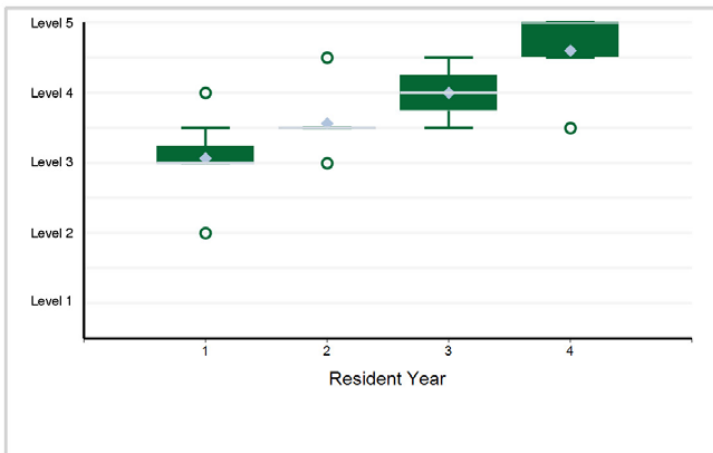

2. Patient Care - Patient Care 2: Neurodevelopmental Examination

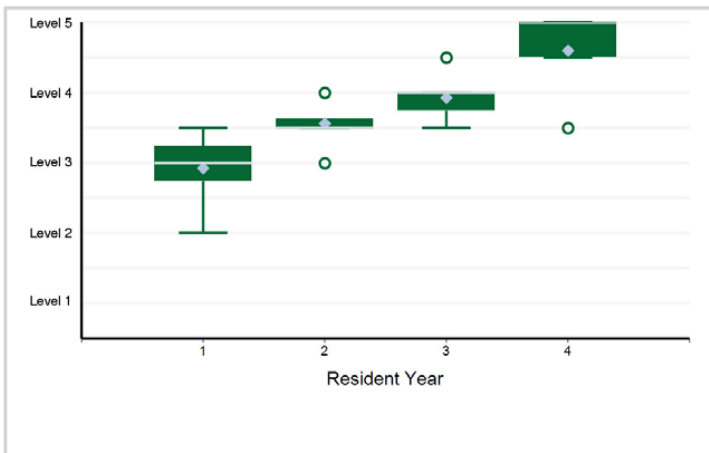

3. Patient Care - Patient Care 3: Neurodevelopmental Disabilities

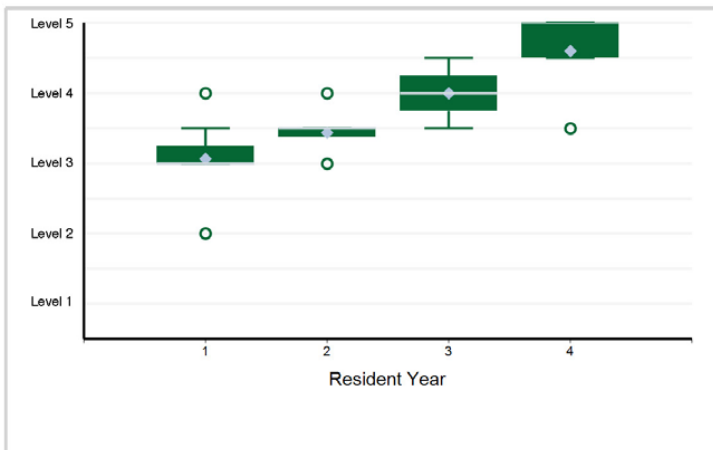

4. Patient Care - Patient Care 4: Behavioral and Psychiatric Disorders

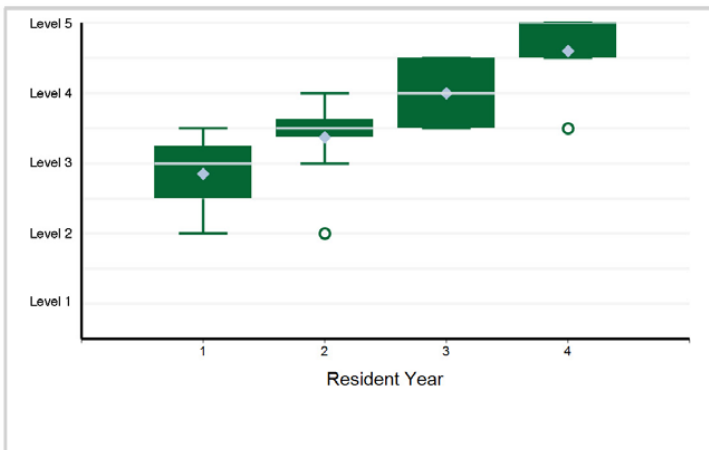

5. Patient Care - Patient Care 5: Critical Care

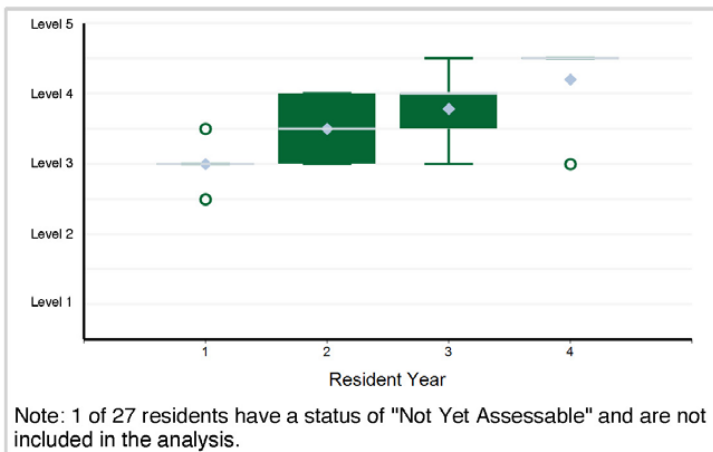

6. Patient Care - Patient Care 6: Diagnosis and Management in the Inpatient Setting

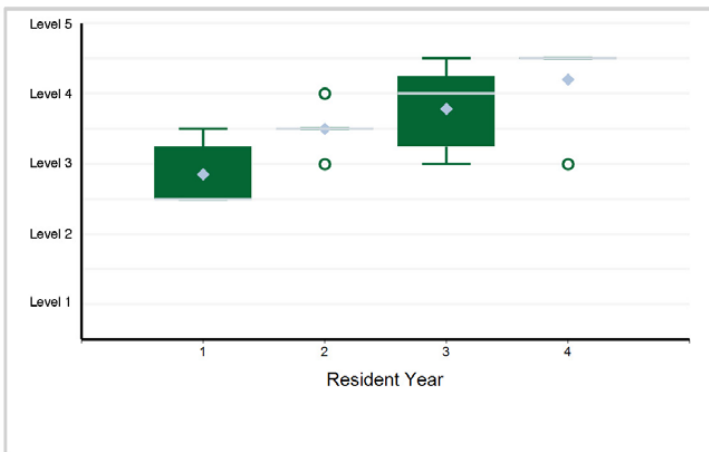

Note: 1 of 27 residents have a status of "Not Yet Assessable" and are not included in the analysis.

Specialty Box Plot Report - Milestone Evaluation by Resident Year: Year-End 2021-2022

SUBSPECIALTY: Neurodevelopmental Disabilities

7. Patient Care - Patient Care 7: Diagnosis and Management in the Outpatient Setting

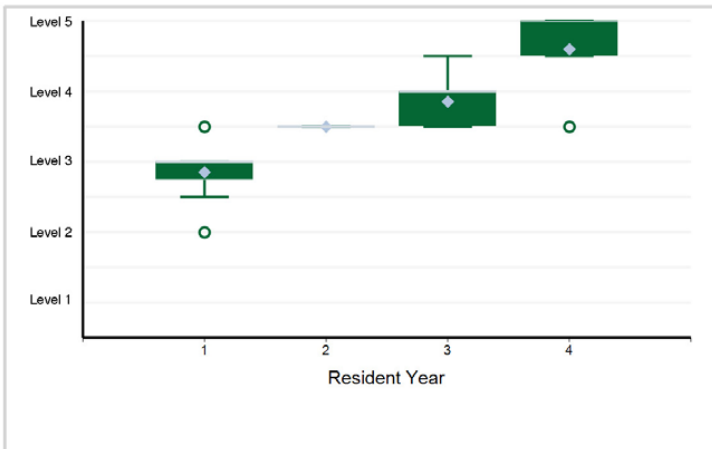

8. Patient Care - Patient Care 8: Electroencephalogram (EEG)

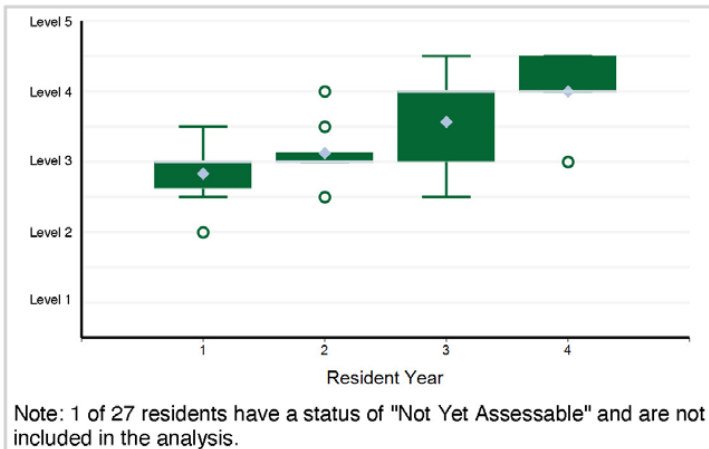

9. - Patient Care 9: Lumbar Puncture

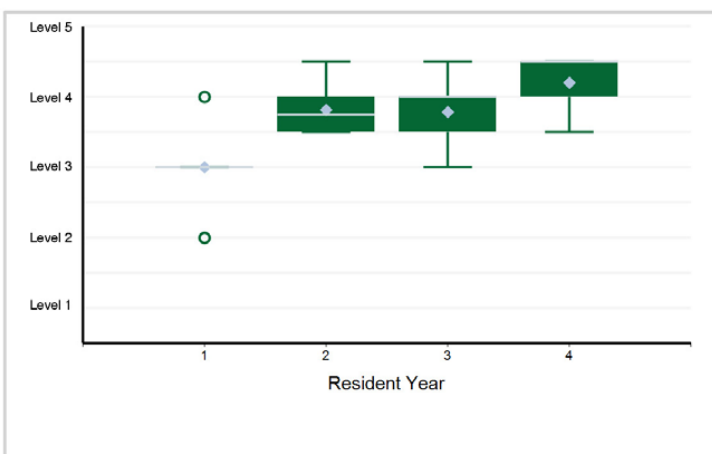

10. - Patient Care 10: Determination of Death by Neurologic Criteria

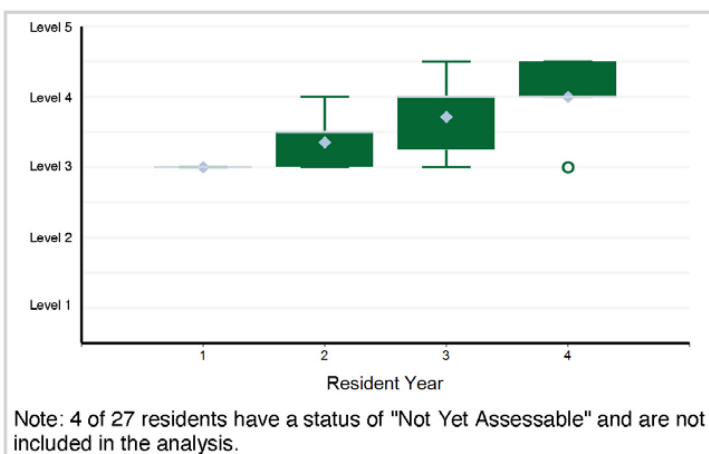

11. Medical Knowledge - Medical Knowledge 1: Development and Behavior

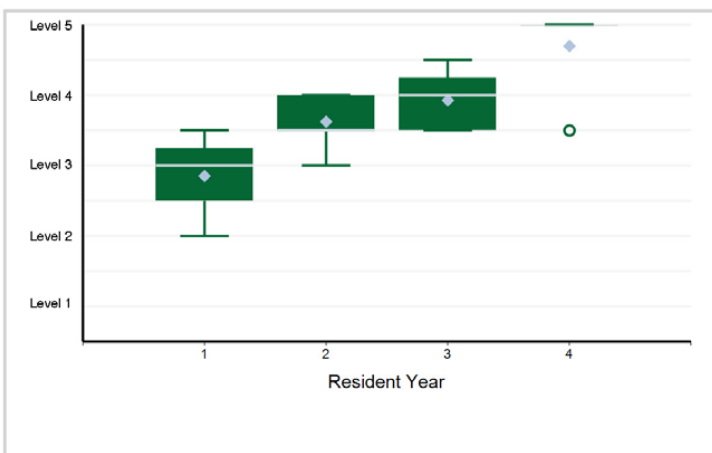

12. Medical Knowledge - Medical Knowledge 2: Localization

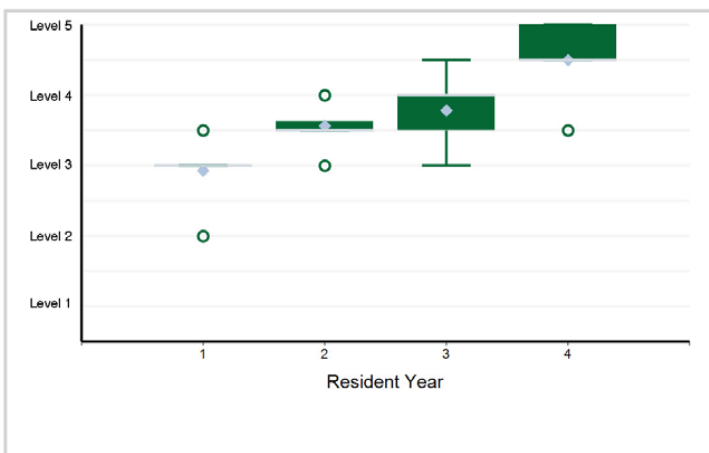

Specialty Box Plot Report - Milestone Evaluation by Resident Year: Year-End 2021-2022

SUBSPECIALTY: Neurodevelopmental Disabilities

13. Medical Knowledge - Medical Knowledge 3: Neuroimaging

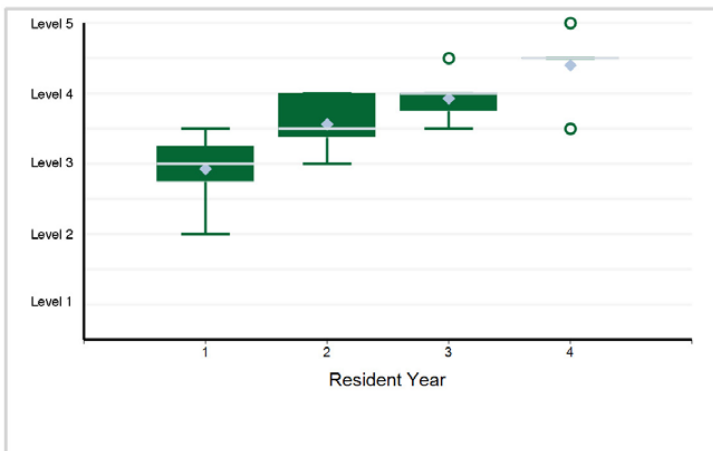

14. Medical Knowledge - Medical Knowledge 4: Electromyography

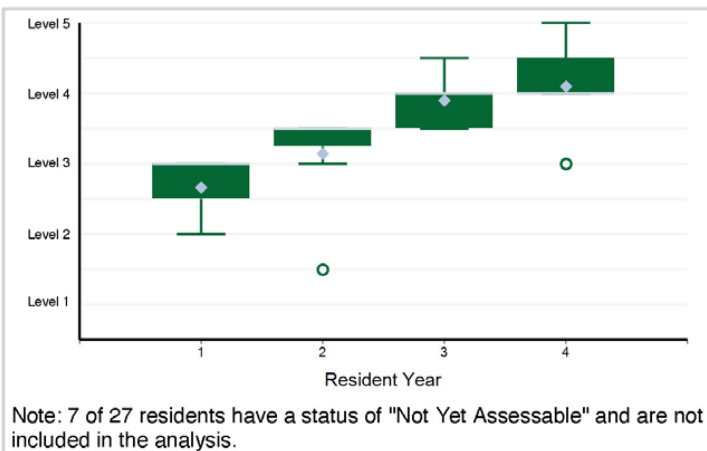

15. Medical Knowledge - Medical Knowledge 5: Diagnostic Investigation

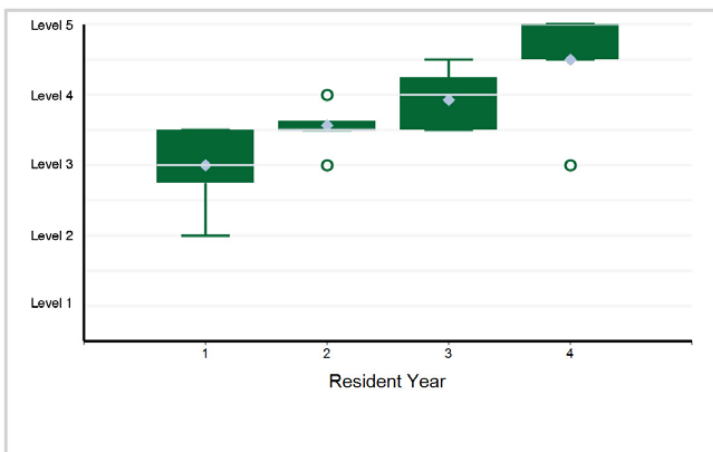

16. Systems-Based Practice - Systems-Based Practice 1: Patient Safety

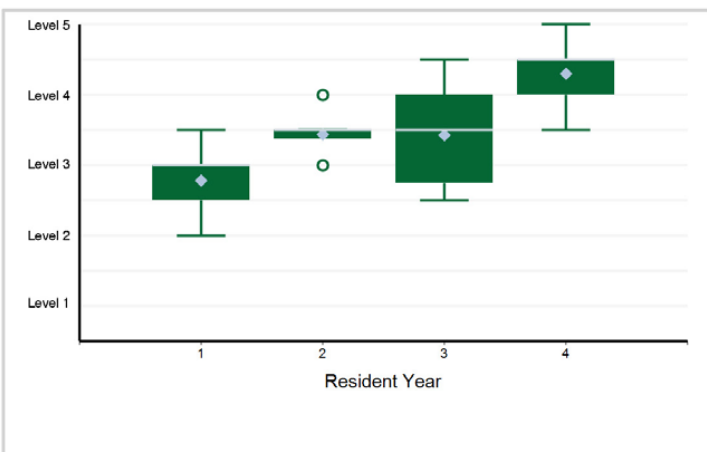

17. Systems-Based Practice - Systems-Based Practice 2: Quality Improvement

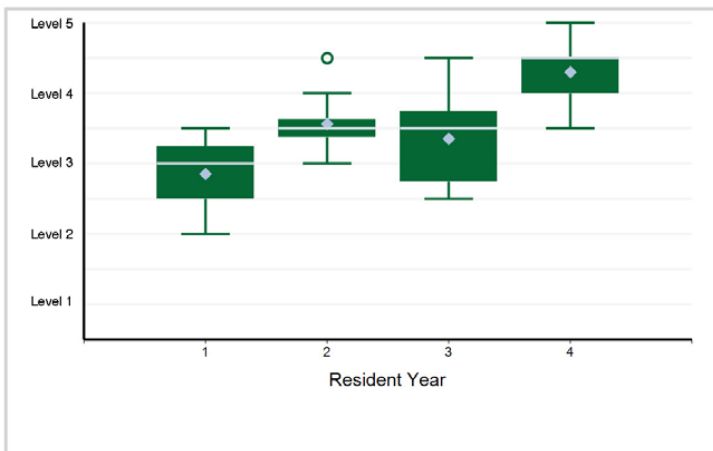

18. Systems-Based Practice - Systems-Based Practice 3: Systems of Care Delivery: Patient- and Family-Centered Care

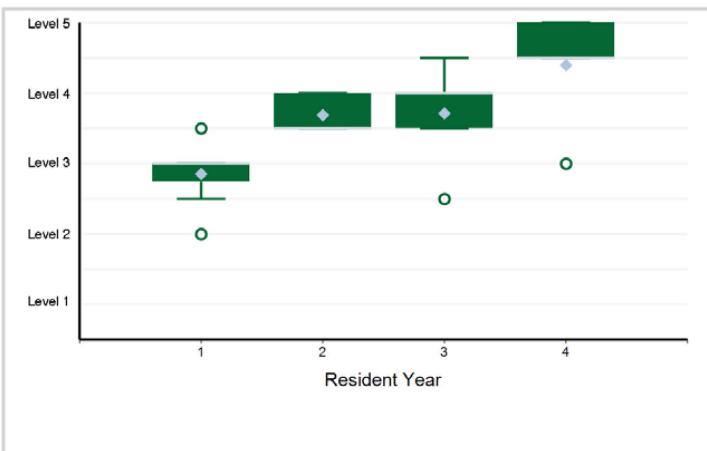

Specialty Box Plot Report - Milestone Evaluation by Resident Year: Year-End 2021-2022

SUBSPECIALTY: Neurodevelopmental Disabilities

19. Systems-Based Practice - Systems-Based Practice 4: Physician Role in Health Care Systems

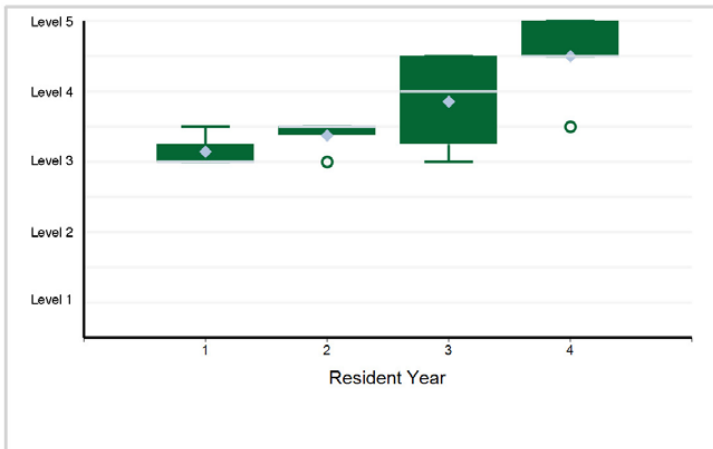

20. - Systems-Based Practice 5: Community Resources

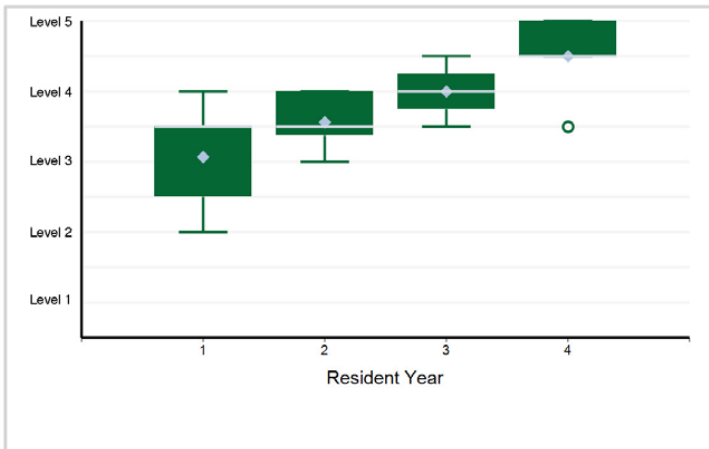

21. - Systems-Based Practice 6: Diversity and Equity that Impact Neurodevelopmental Access and Outcomes

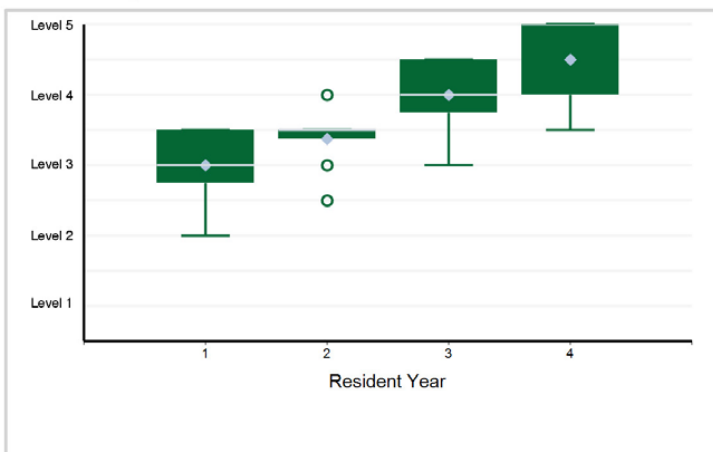

22. Practice-Based Learning and Improvement - Practice-Based Learning and Improvement 1: Evidence-Based and Informed Practice

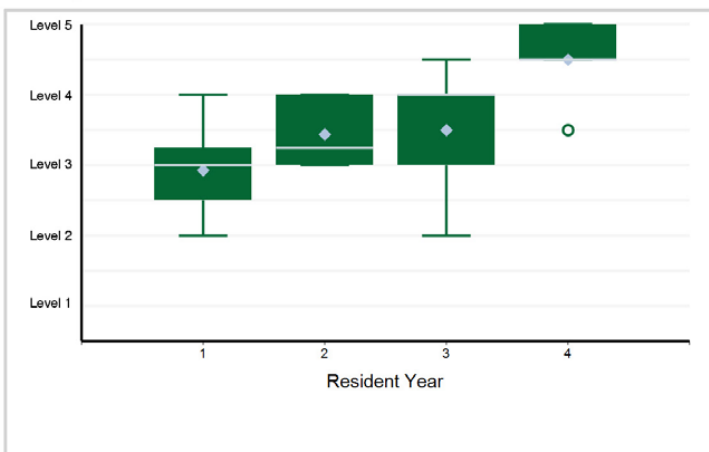

23. Practice-Based Learning and Improvement - Practice-Based Learning and Improvement 2: Reflective Practice and Commitment ...

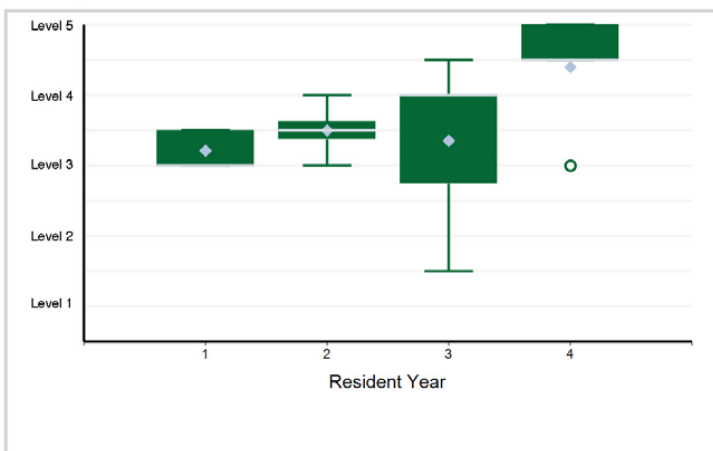

24. Professionalism - Professionalism 1: Professional Behavior

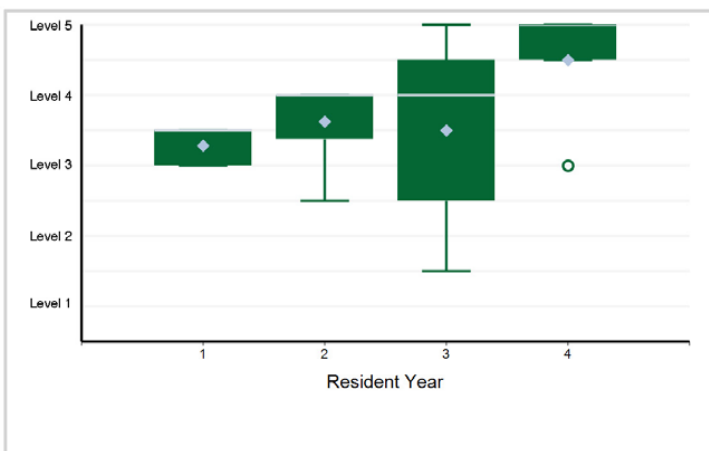

Specialty Box Plot Report - Milestone Evaluation by Resident Year: Year-End 2021-2022

SUBSPECIALTY: Neurodevelopmental Disabilities

25. Professionalism - Professionalism 2: Ethical Principles

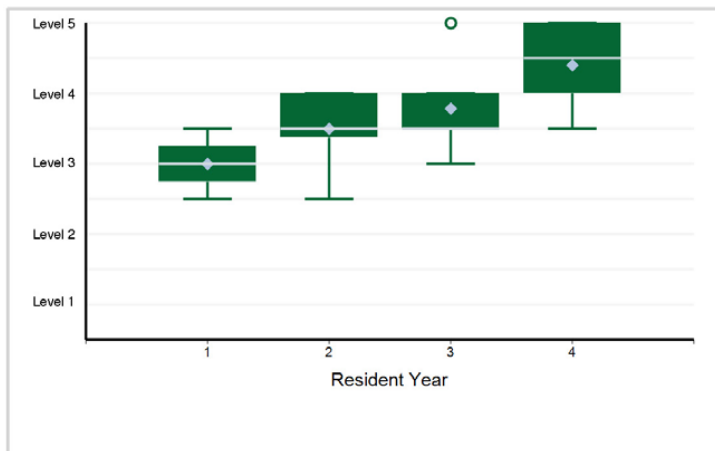

26. Professionalism - Professionalism 3: Accountability/Conscientiousness

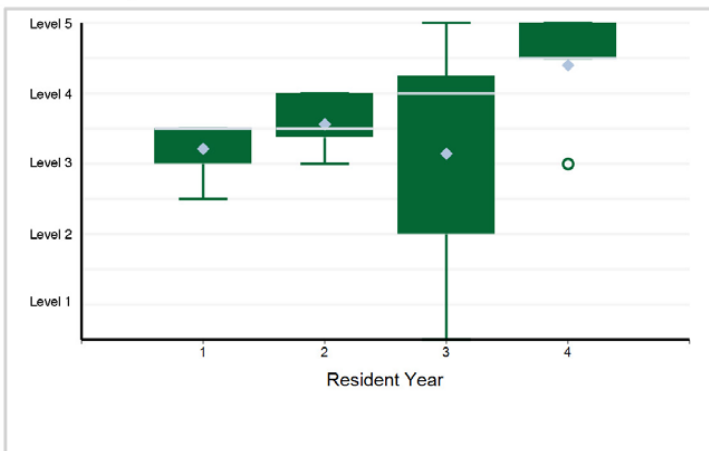

27. Professionalism - Professionalism 4: Well-Being

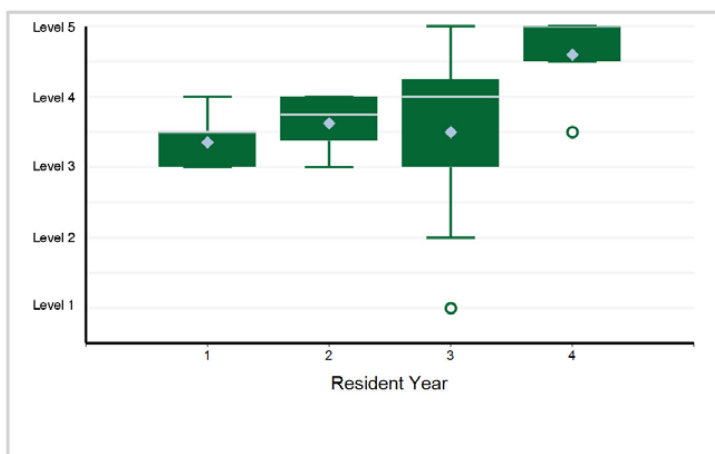

28. - Professionalism 5: Patient Care Etiquette with Patients of all Abilities

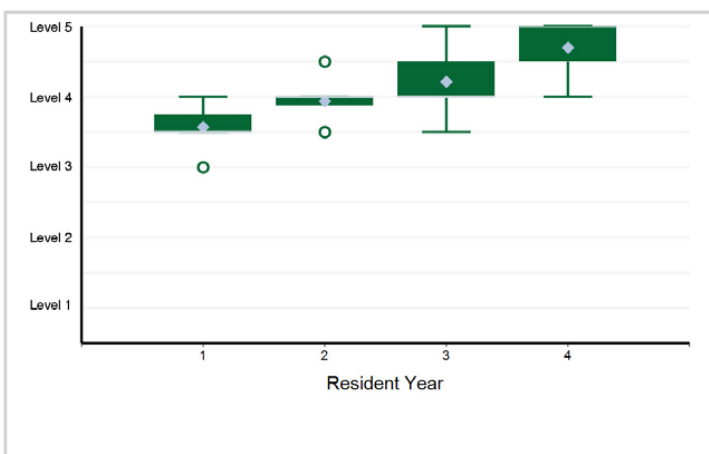

29. Interpersonal and Communication Skills - Interpersonal and Communication Skills 1: Patient- and Family-Centered Communication

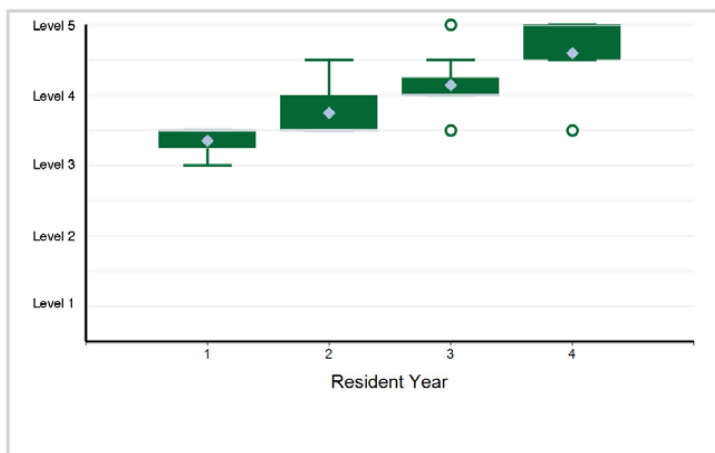

30. Interpersonal and Communication Skills - Interpersonal and Communication Skills 2: Patient and Family Education

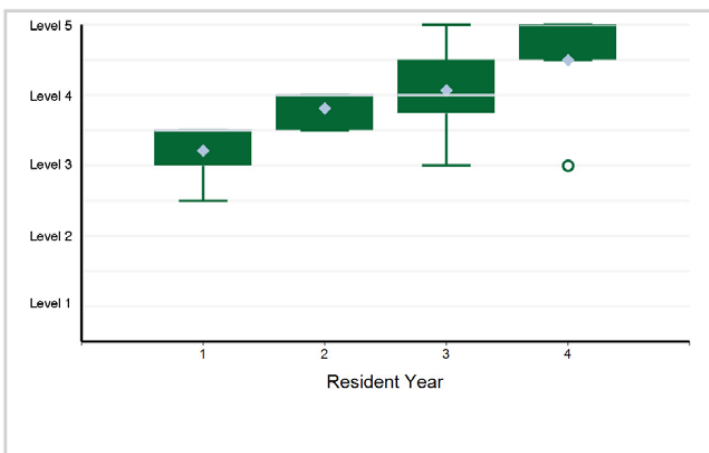

Specialty Box Plot Report - Milestone Evaluation by Resident Year: Year-End 2021-2022

SUBSPECIALTY: Neurodevelopmental Disabilities

31. Interpersonal and Communication Skills - Interpersonal and Communication Skills 3: Interprofessional and Team Communication

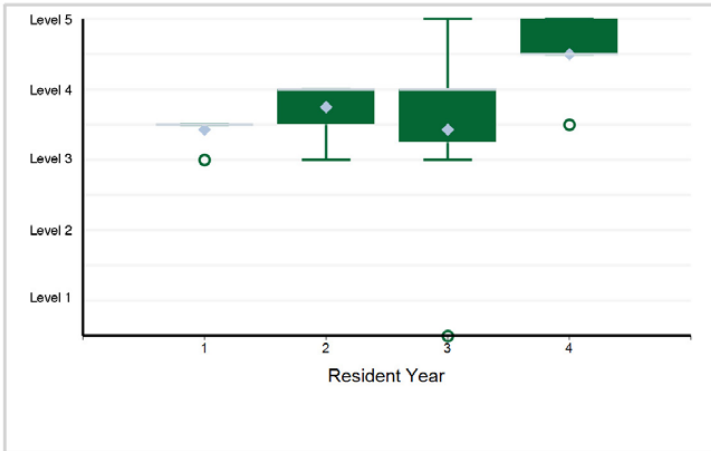

32. Interpersonal and Communication Skills - Interpersonal and Communication Skills 4: Communication within Health Care Systems

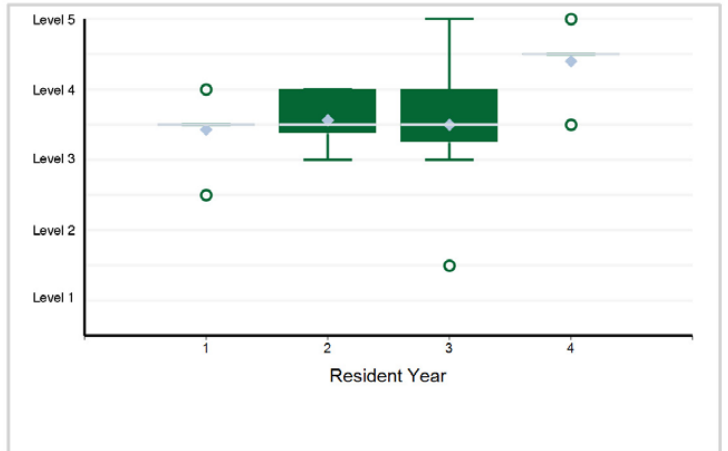

Specialty Box Plot Report - Milestone Evaluation by Resident Year: Year-End 2021-2022

TABLE 59: SUBSPECIALTY: **Neuromuscular Medicine (multidisciplinary, Neurology)**

Resident Year	1	Total Residents
# of Residents	73	73

1. Patient Care - History — Patient Care

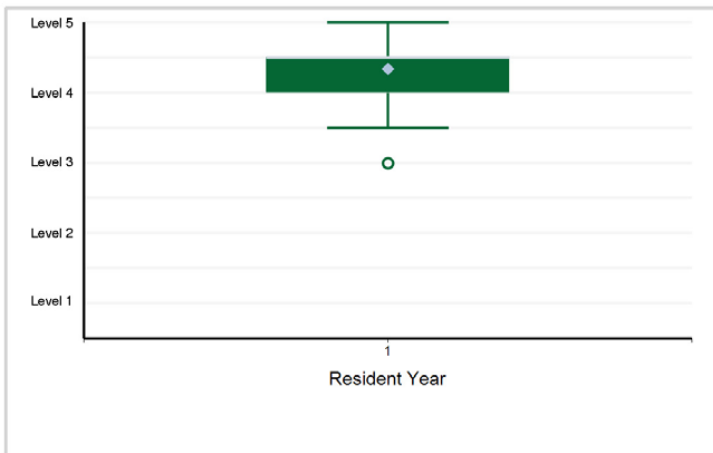

2. Patient Care - Neuromuscular Exam — Patient Care

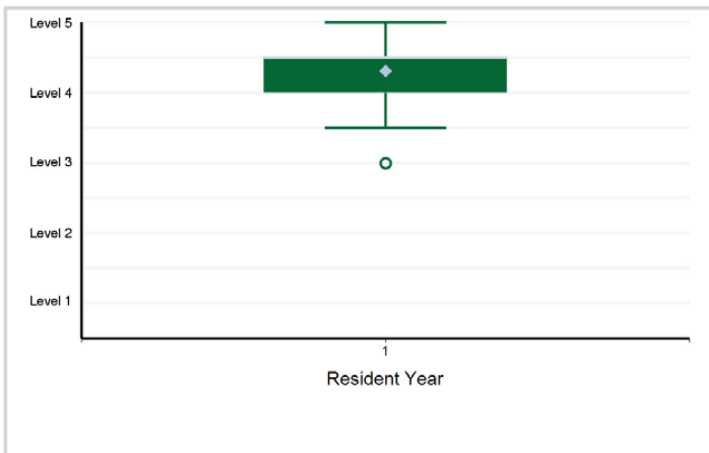

3. Patient Care - Management/Treatment — Patient Care

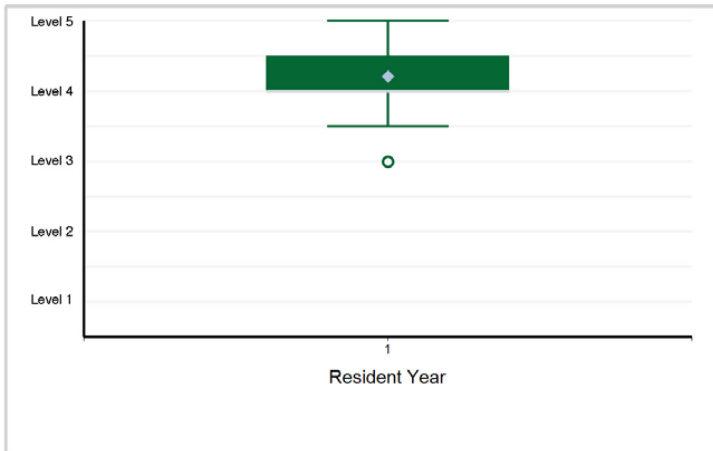

4. Patient Care - Nerve Conduction Studies (NCS) — Patient Care

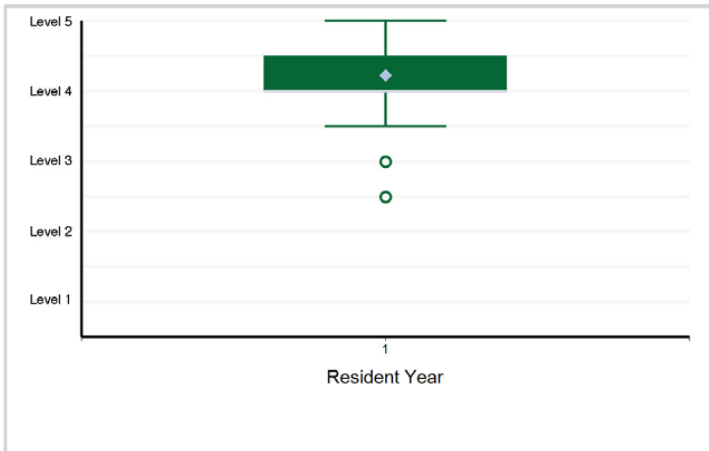

5. Patient Care - EMG — Patient Care

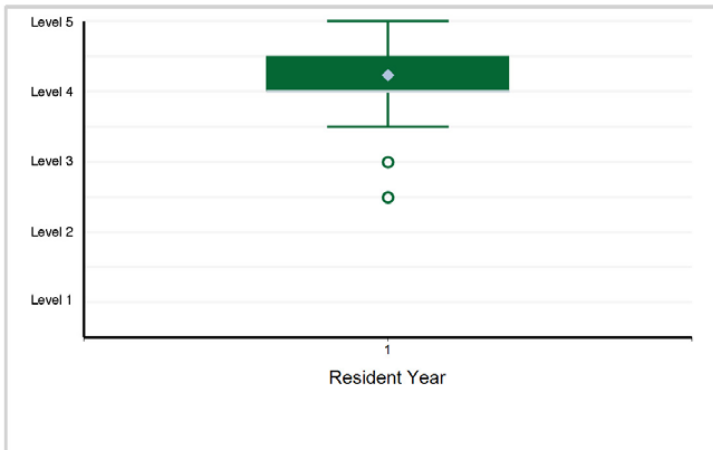

6. Patient Care - Anterior Horn Cell Disorders — Patient Care

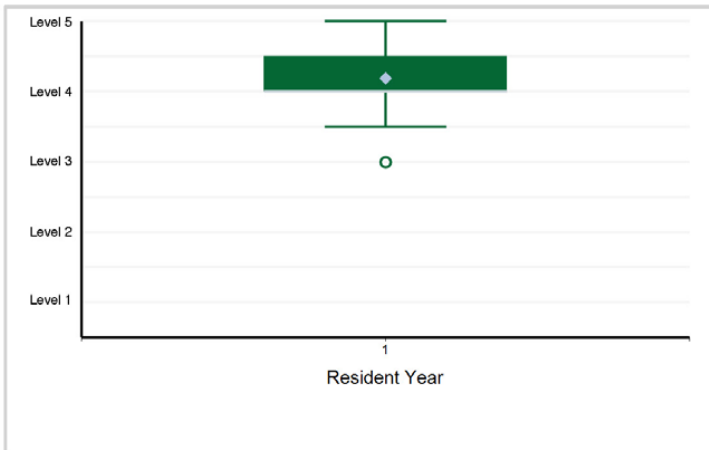

Specialty Box Plot Report - Milestone Evaluation by Resident Year: Year-End 2021-2022

SUBSPECIALTY: Neuromuscular Medicine (multidisciplinary, Neurology)

7. Patient Care - Root, Plexus, and Peripheral Nerve Disorders — Patient Care

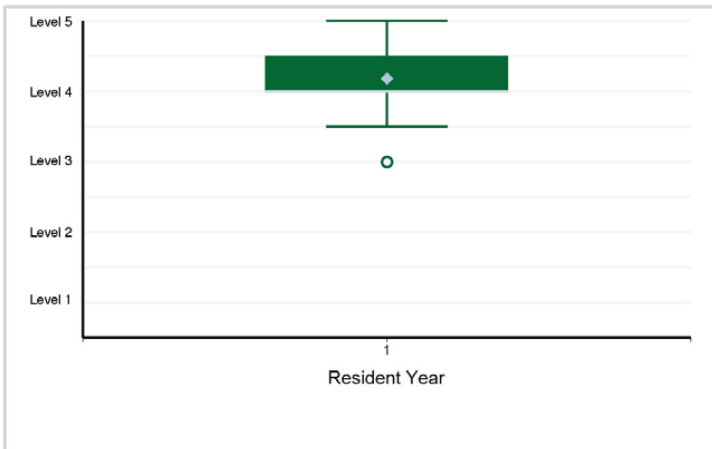

8. Patient Care - Neuromuscular Junction Disorders — Patient Care

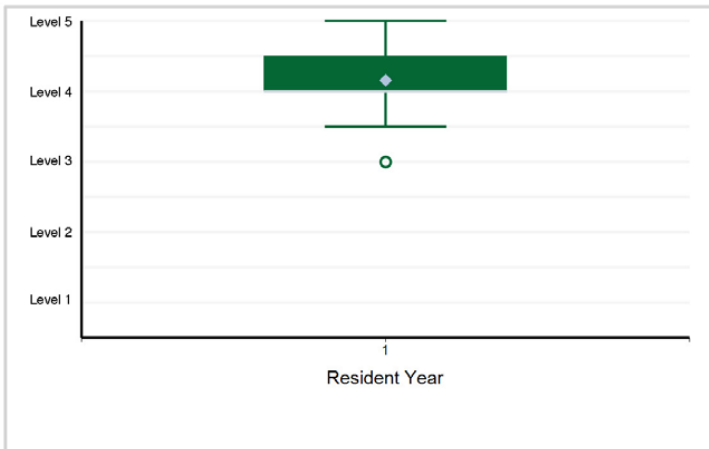

9. Patient Care - Myopathies — Patient Care

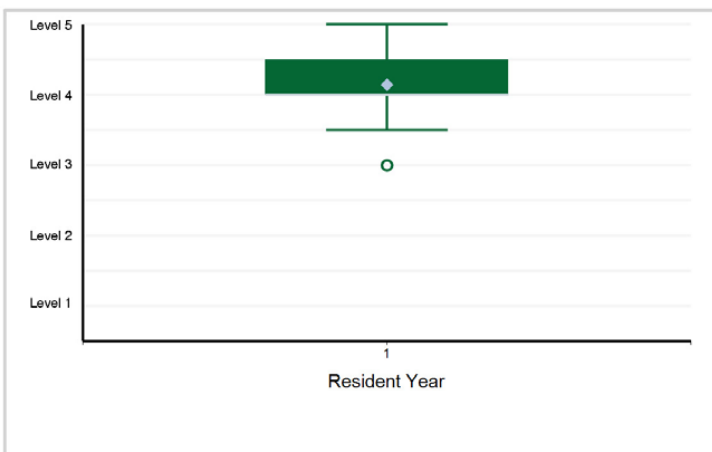

10. Medical Knowledge - Localization — Medical Knowledge

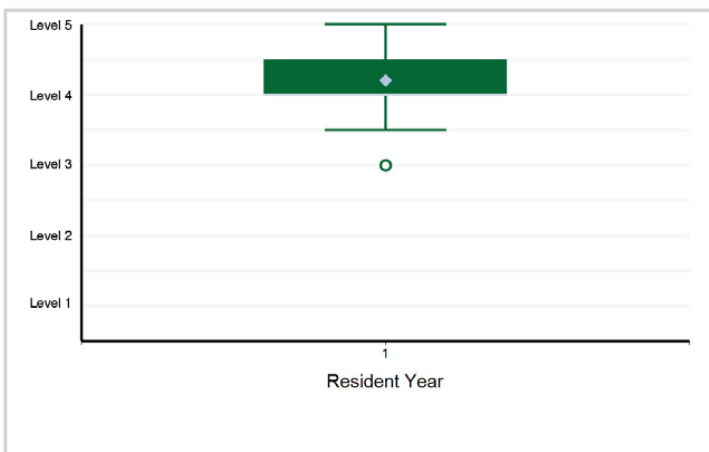

11. Medical Knowledge - Formulation — Medical Knowledge

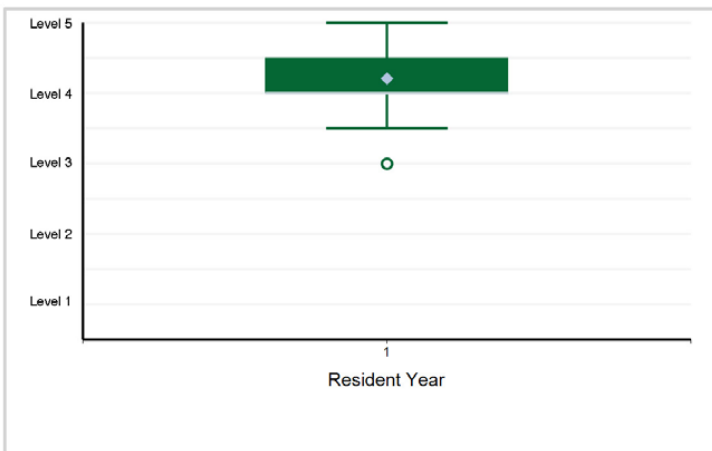

12. Medical Knowledge - Diagnostic Investigation — Medical Knowledge

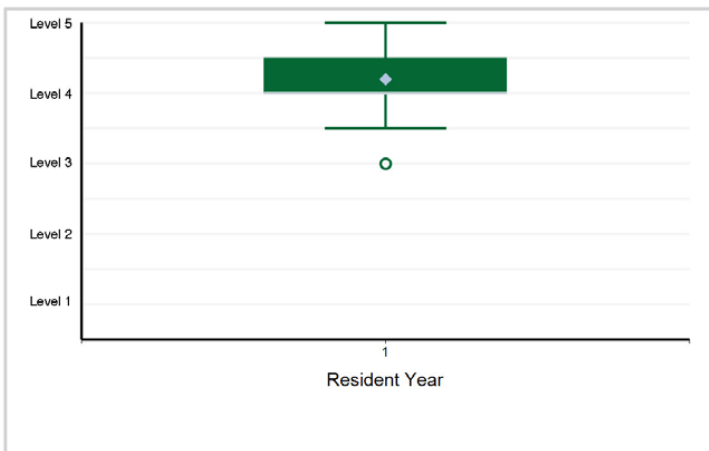

Specialty Box Plot Report - Milestone Evaluation by Resident Year: Year-End 2021-2022

SUBSPECIALTY: Neuromuscular Medicine (multidisciplinary, Neurology)

13. Medical Knowledge - Muscle and Nerve Pathology — Medical Knowledge

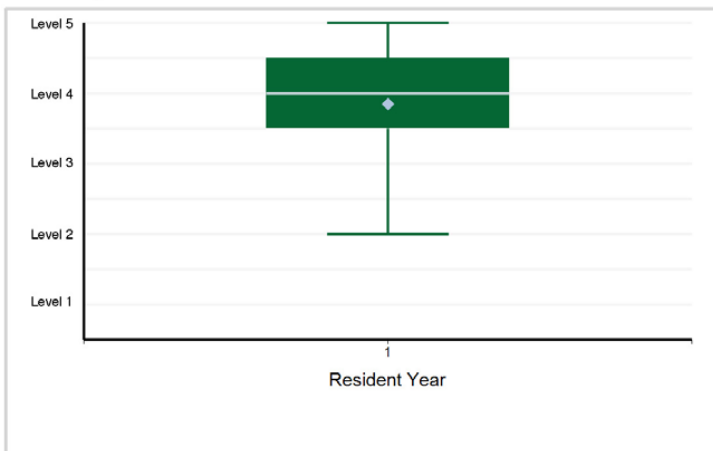

14. Systems-Based Practice - Systems Thinking, Including Cost- and Risk-effective Practice — Systems-Based Practice

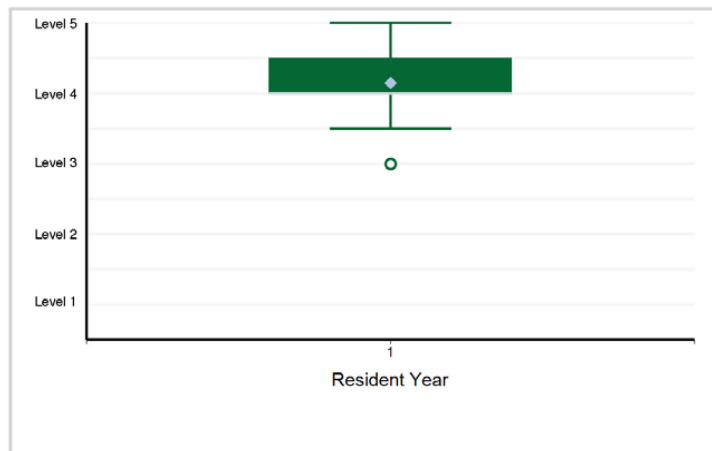

15. Systems-Based Practice - Work in Interprofessional Teams to Enhance Patient Safety and Patient Care — Systems-Based Practice

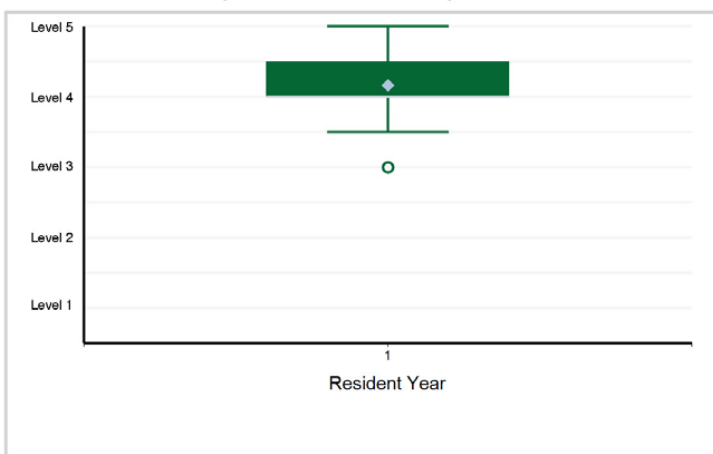

16. Practice-Based Learning and Improvement - Self-directed Learning — Practice-Based Learning and Improvement ...

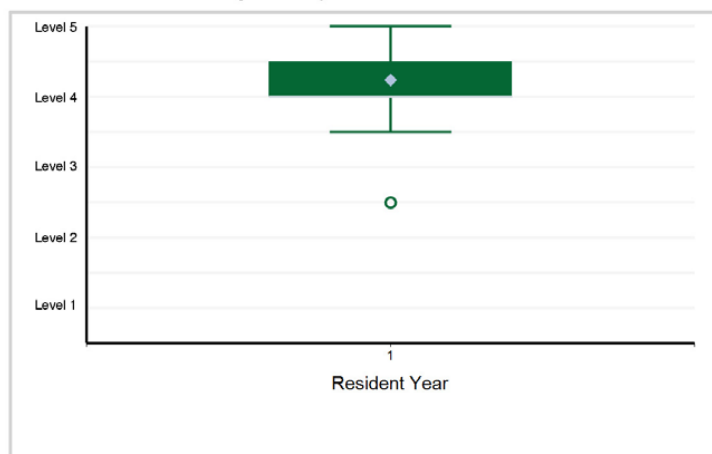

17. Practice-Based Learning and Improvement - Locate, Appraise, and Assimilate Evidence from Scientific ...

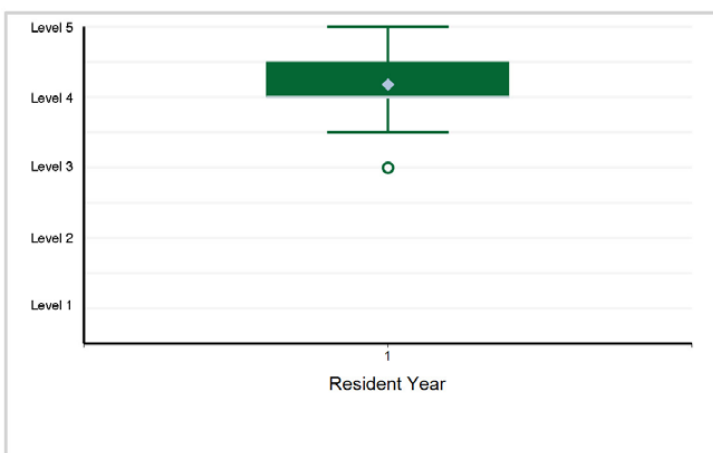

18. Professionalism - Compassion, Integrity, Accountability, and Respect for Self and Others — Professionalism

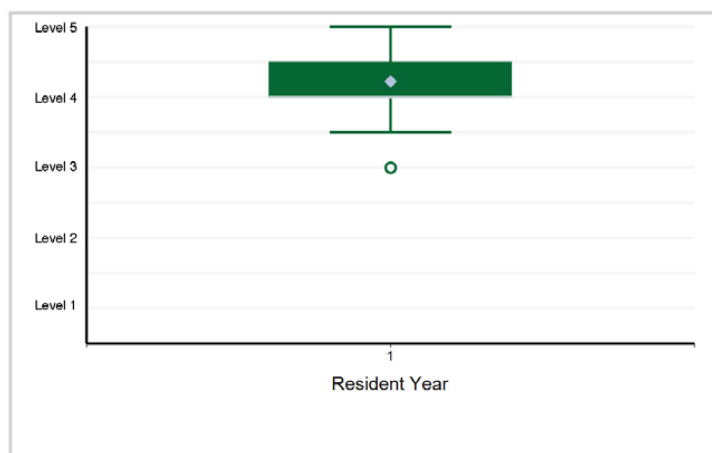

Specialty Box Plot Report - Milestone Evaluation by Resident Year: Year-End 2021-2022

SUBSPECIALTY: Neuromuscular Medicine (multidisciplinary, Neurology)

19. Professionalism - Knowledge About, Respect for, and Adherence to the Ethical Principles Relevant to ...

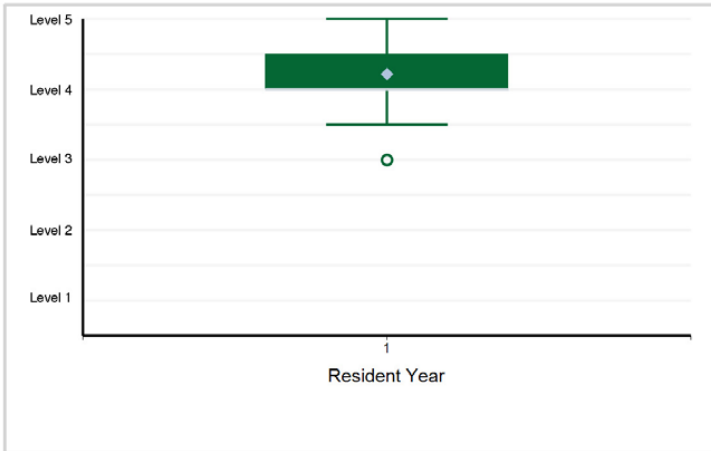

20. Interpersonal and Communication Skills - Relationship Development, Teamwork, and Managing Conflict — ...

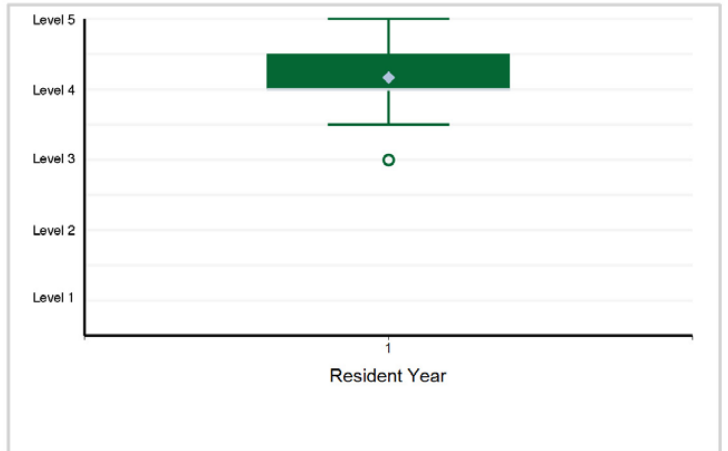

21. Interpersonal and Communication Skills - Information Sharing, Gathering, and Technology — Interpersonal ...

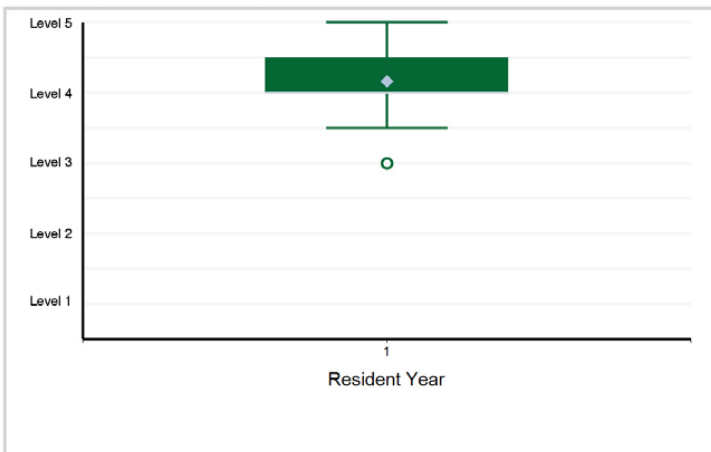

Specialty Box Plot Report - Milestone Evaluation by Resident Year: Year-End 2021-2022

TABLE 60: SUBSPECIALTY: **Vascular Neurology**

Resident Year	1	Total Residents*
# of Residents	154	154

*Note: There are 2 residents with an incomplete milestone evaluation that are excluded from the box plots below.

1. Patient Care - Patient Care 1: History

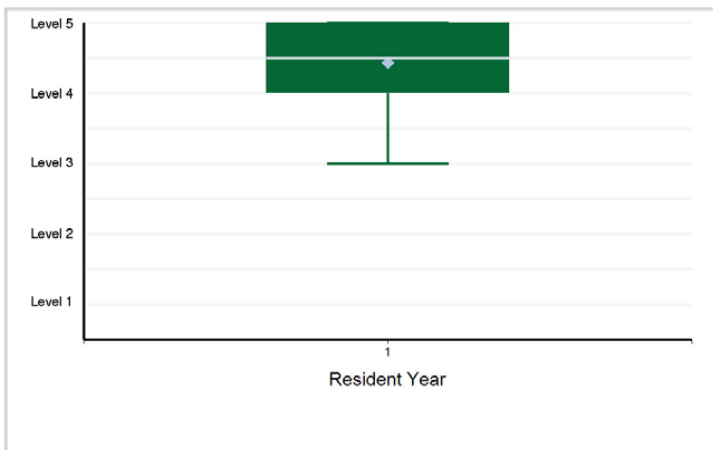

2. Patient Care - Patient Care 2: Vascular Neurological Examination

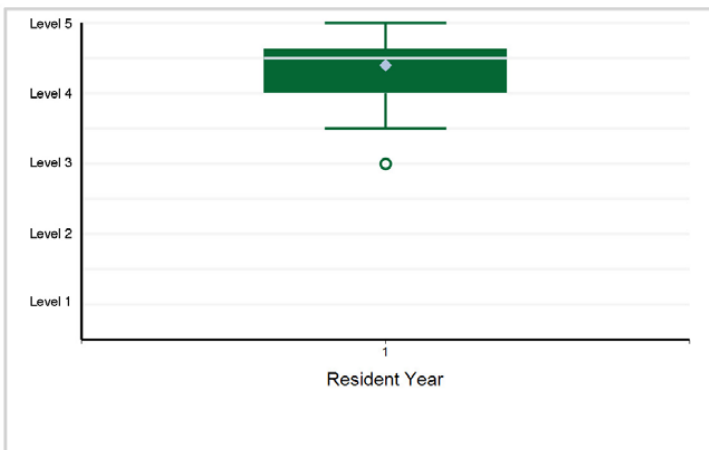

3. Patient Care - Patient Care 3: Acute Stroke Intervention and Management

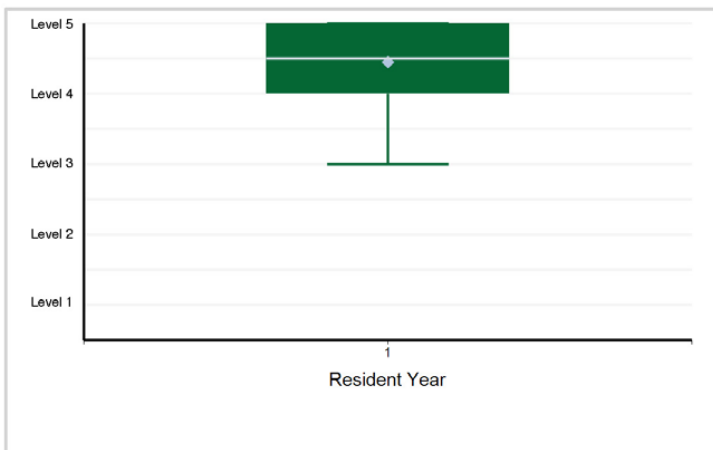

4. Patient Care - Patient Care 4: Post-Acute Care

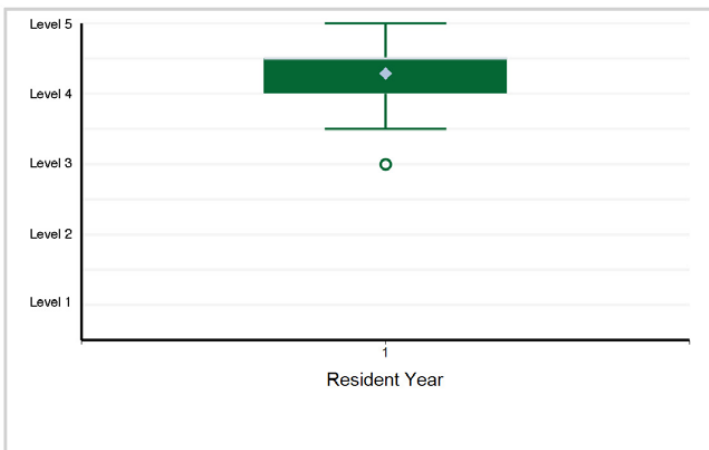

5. Patient Care - Patient Care 5: Telestroke/Remote Consultation/Consultation

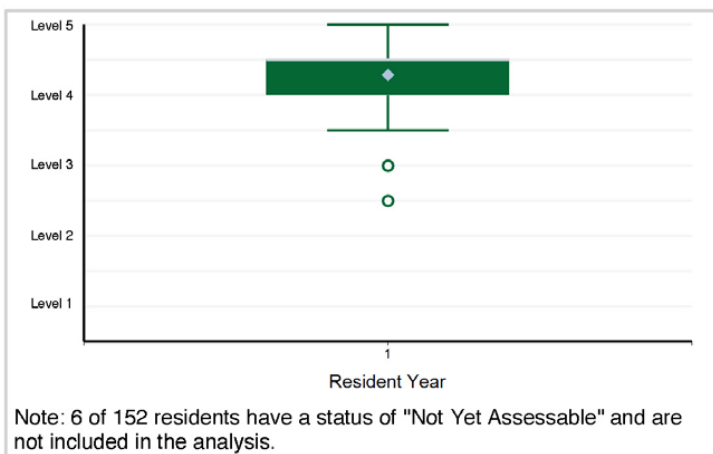

Note: 6 of 152 residents have a status of "Not Yet Assessable" and are not included in the analysis.

6. Medical Knowledge - Medical Knowledge 1: Localization

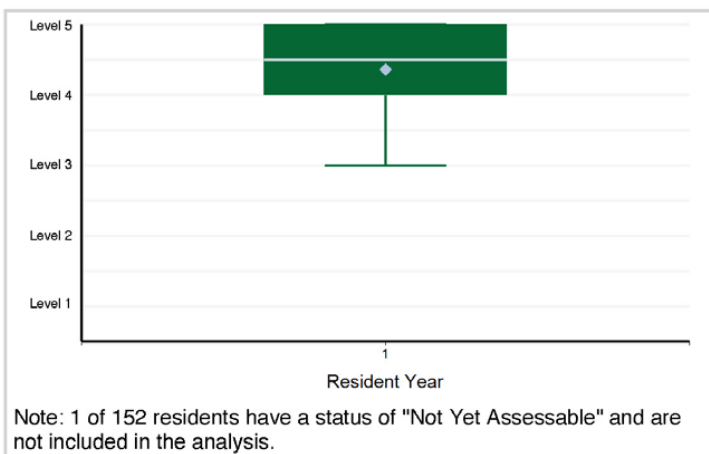

Note: 1 of 152 residents have a status of "Not Yet Assessable" and are not included in the analysis.

Specialty Box Plot Report - Milestone Evaluation by Resident Year: Year-End 2021-2022

SUBSPECIALTY: Vascular Neurology

7. Medical Knowledge - Medical Knowledge 2: Formulation

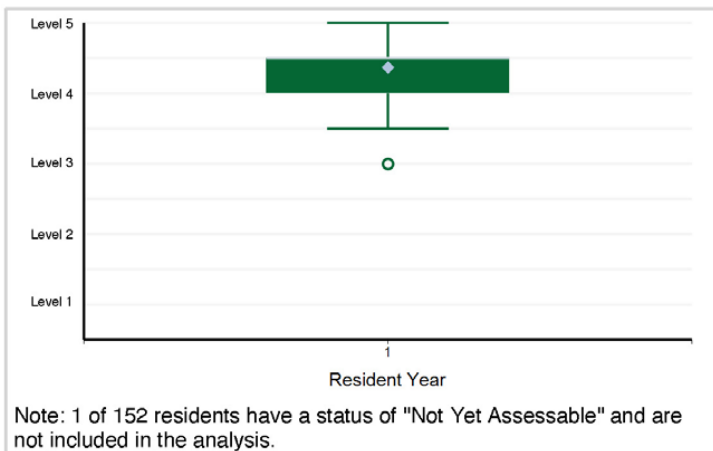

8. Medical Knowledge - Medical Knowledge 3: Multimodal Imaging in Vascular Neurology (e.g., Computed Tomography ...

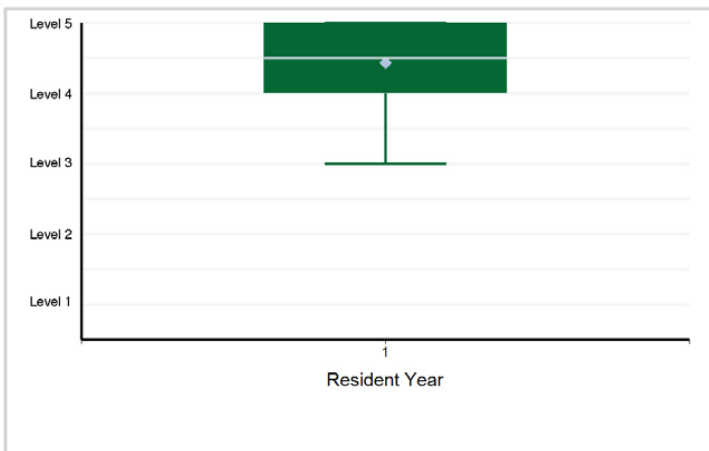

9. Medical Knowledge - Medical Knowledge 4: Diagnostic Investigation in Vascular Neurology

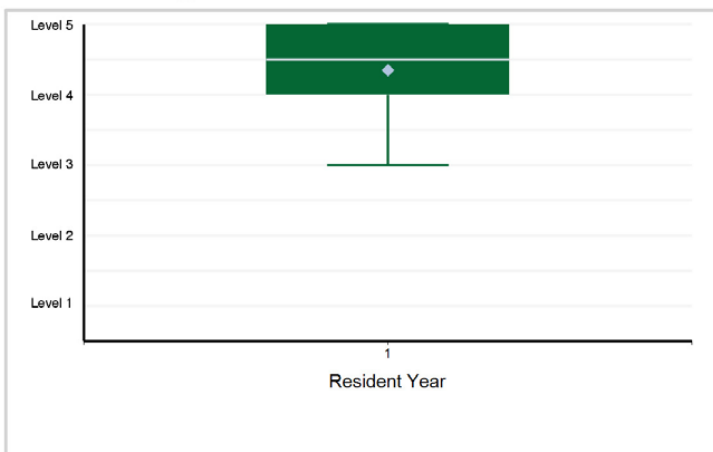

10. Medical Knowledge - Medical Knowledge 5: Ischemic Stroke

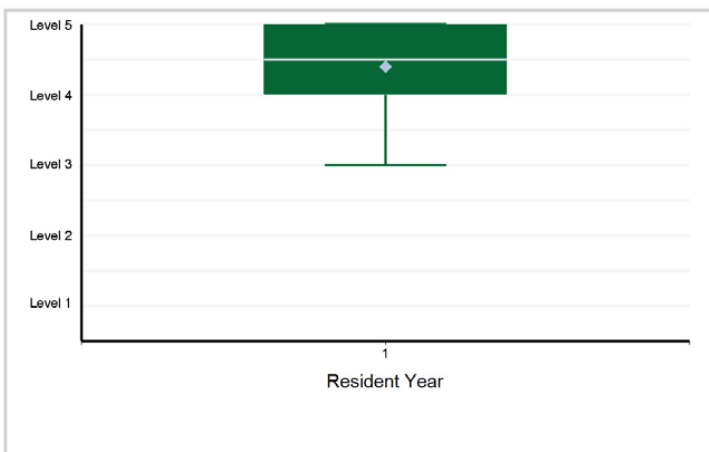

11. Medical Knowledge - Medical Knowledge 6: Intracerebral Hemorrhage

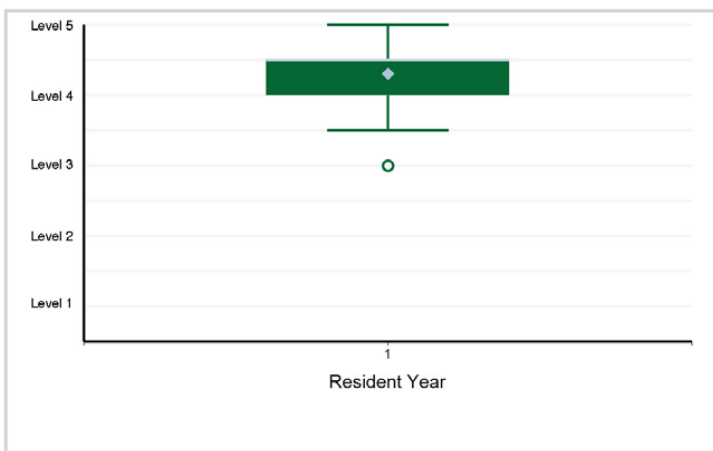

12. Medical Knowledge - Medical Knowledge 7: Subarachnoid Hemorrhage

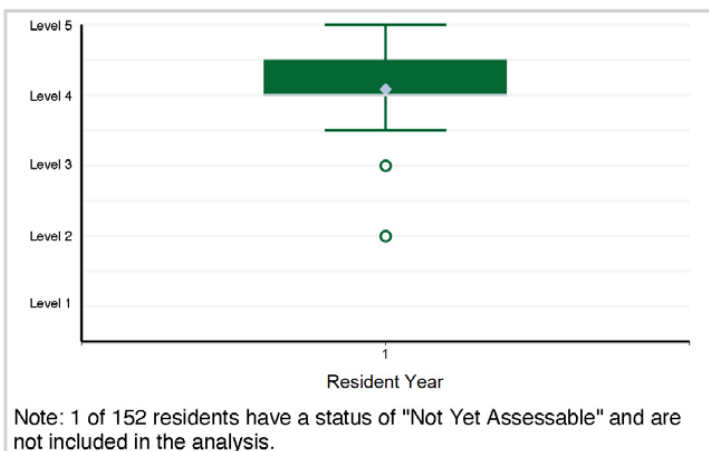

Specialty Box Plot Report - Milestone Evaluation by Resident Year: Year-End 2021-2022

SUBSPECIALTY: Vascular Neurology

13. Systems-Based Practice - Systems-Based Practice 1: Patient Safety

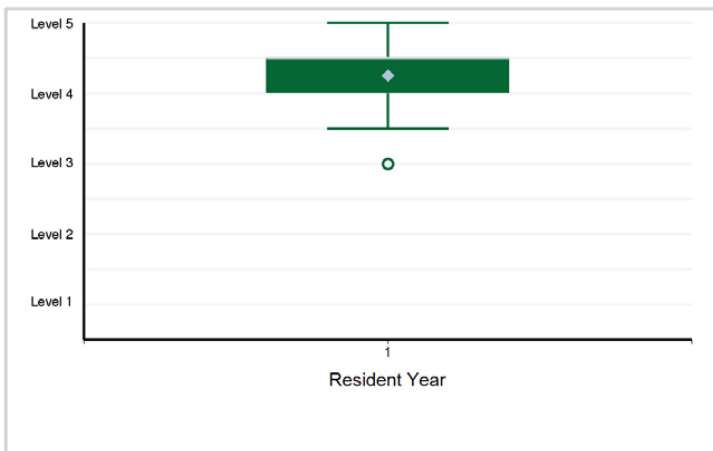

14. Systems-Based Practice - Systems-Based Practice 2: Quality Improvement in Stroke System of Care

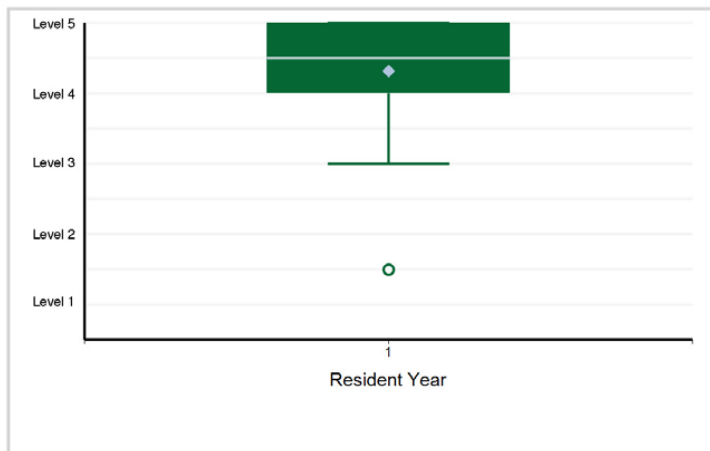

15. Systems-Based Practice - Systems-Based Practice 3: System Navigation for Patient-Centered Care

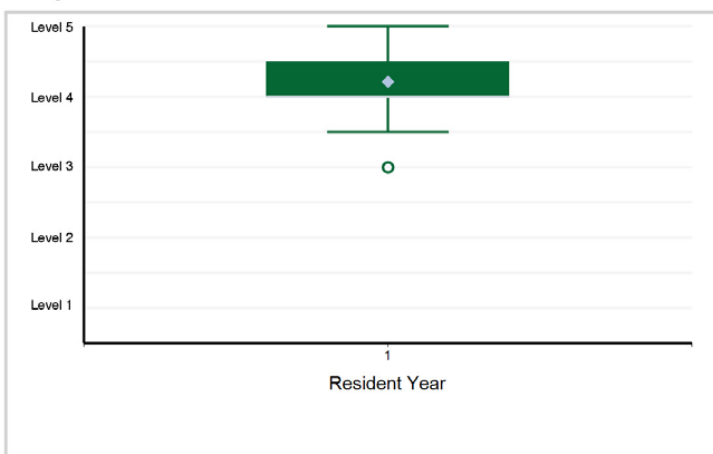

16. Systems-Based Practice - Systems-Based Practice 4: Physician Role in Health Care Systems



17. Practice-Based Learning and Improvement - Practice-Based Learning and Improvement 1: Evidence-Based and Informed Practice

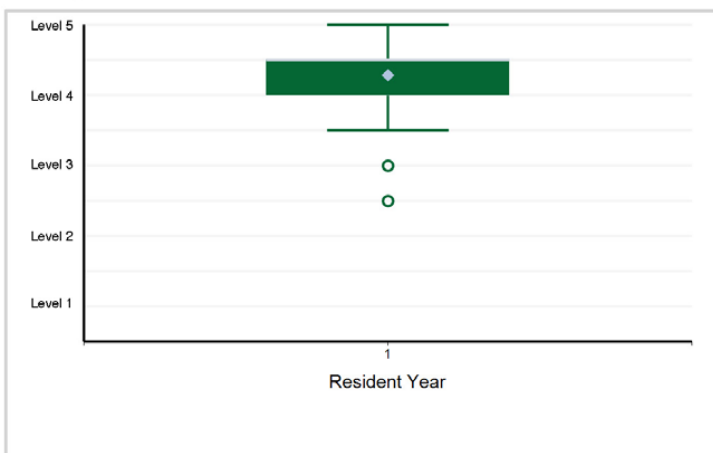

18. Practice-Based Learning and Improvement - Practice-Based Learning and Improvement 2: Reflective Practice and Commitment ...

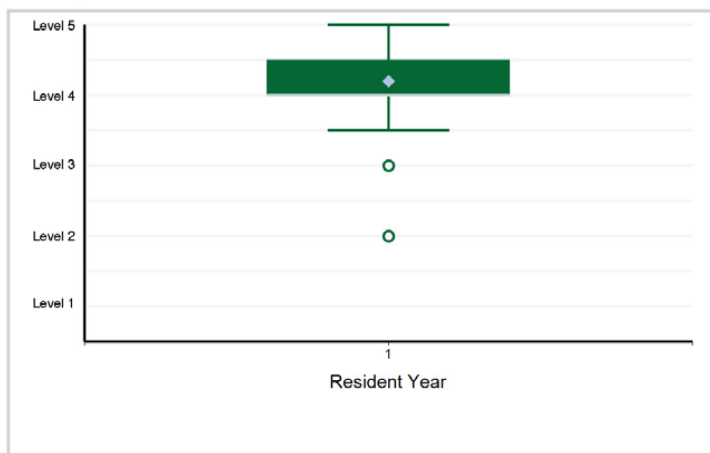

Specialty Box Plot Report - Milestone Evaluation by Resident Year: Year-End 2021-2022

SUBSPECIALTY: Vascular Neurology

19. Professionalism - Professionalism 1: Professional Behavior and Ethical Principles

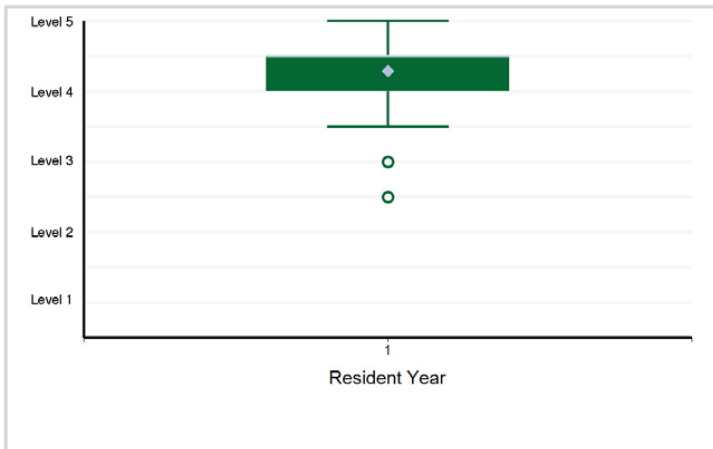

20. Professionalism - Professionalism 2: Accountability/Conscientiousness

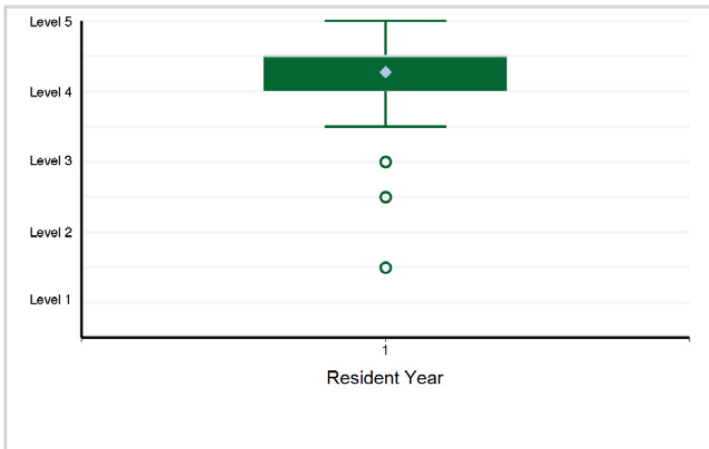

21. Professionalism - Professionalism 3: Well-Being

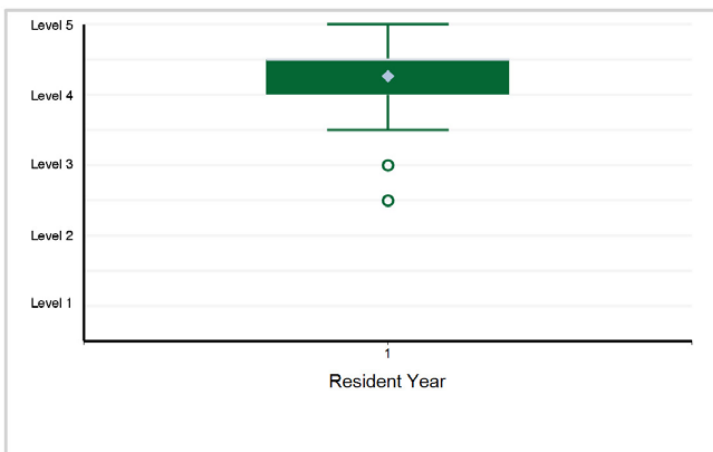

22. Interpersonal and Communication Skills - Interpersonal and Communication Skills 1: Patient- and Family-Centered Communication

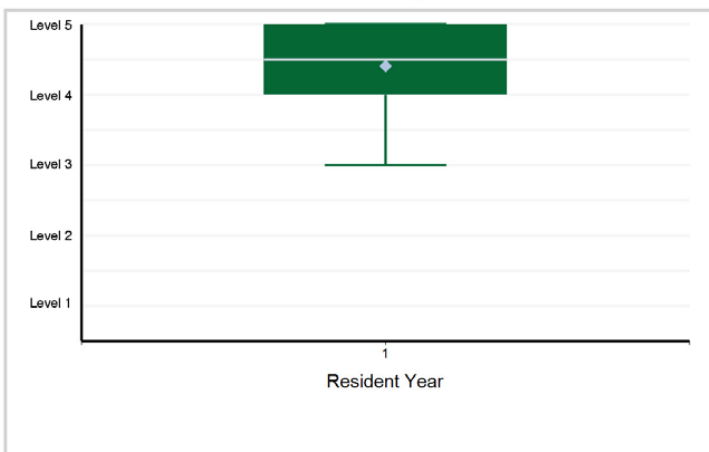

23. Interpersonal and Communication Skills - Interpersonal and Communication Skills 2: Barrier and Bias Mitigation

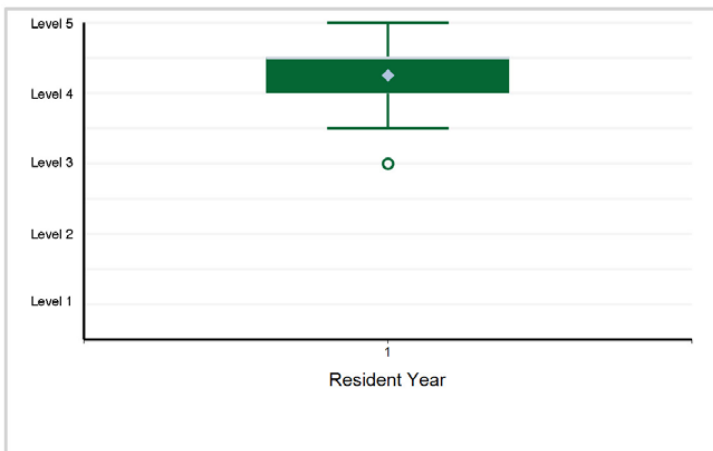

24. Interpersonal and Communication Skills - Interpersonal and Communication Skills 3: Interprofessional and Team Communication

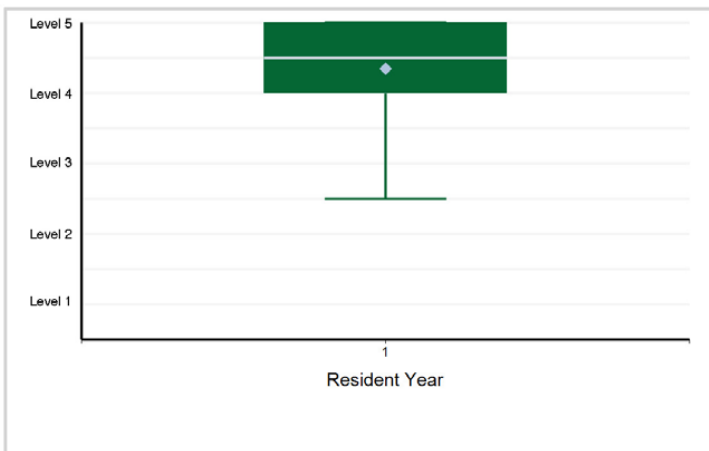

Specialty Box Plot Report - Milestone Evaluation by Resident Year: Year-End 2021-2022

SUBSPECIALTY: **Vascular Neurology**

25. Interpersonal and Communication Skills - Interpersonal and Communication Skills 4: Communication within Health Care Systems

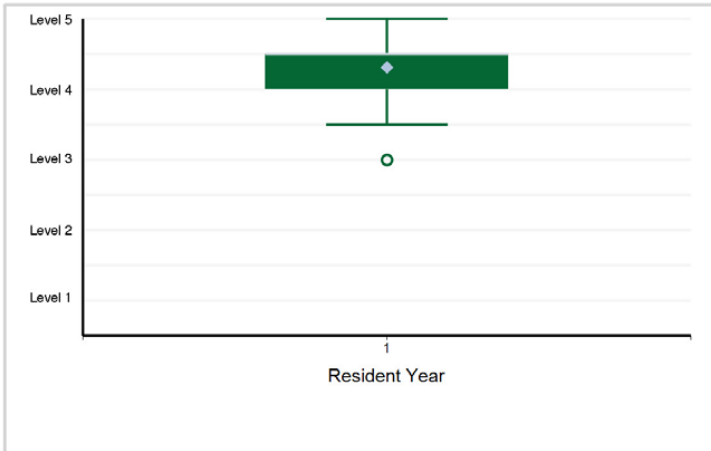

Specialty Box Plot Report - Milestone Evaluation by Resident Year: Year-End 2021-2022

TABLE 61: SPECIALTY: **Child Neurology**

Resident Year	1	2	3	Total Residents
# of Residents	174	148	142	464

1. Patient Care - Patient Care 1: Neurologic and Developmental History

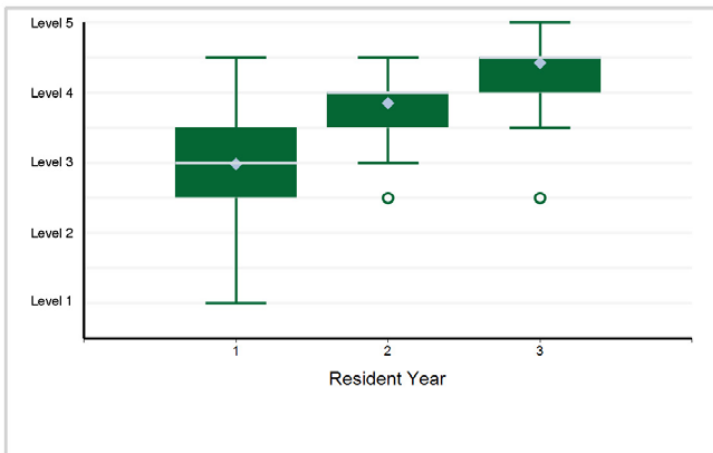

2. Patient Care - Patient Care 2: Neurologic Exam

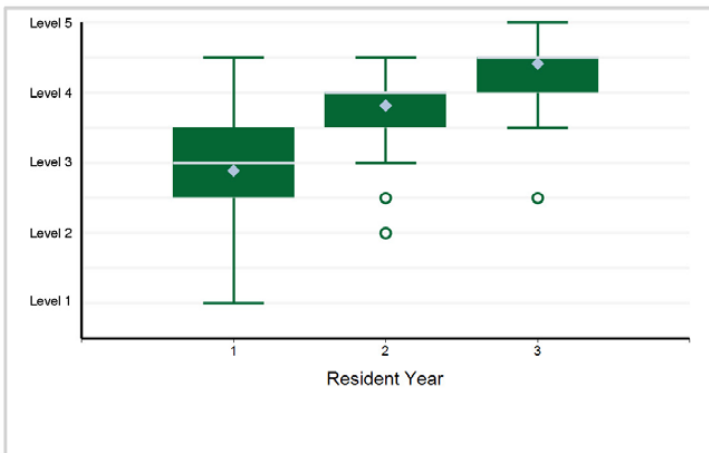

3. Patient Care - Patient Care 3: Critical Care

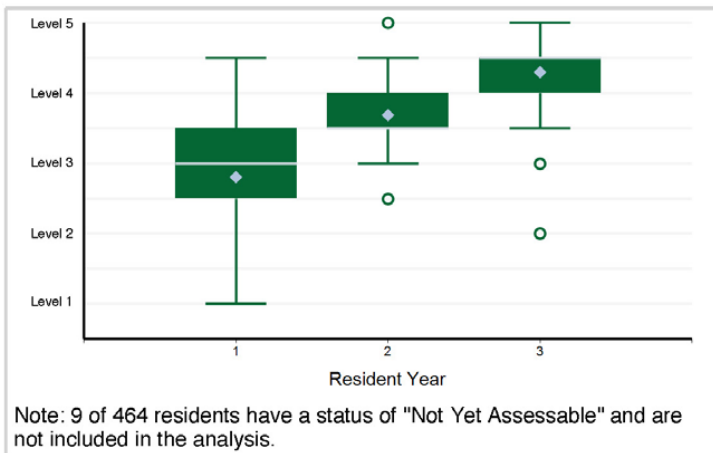

4. Patient Care - Patient Care 4: Diagnosis and Management in the Inpatient Setting

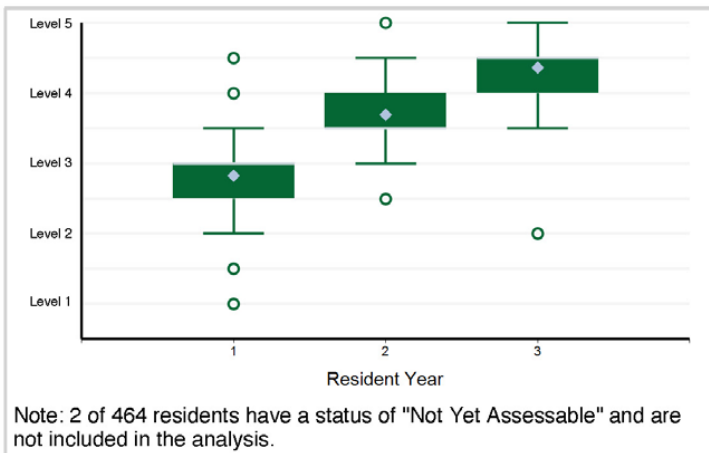

5. Patient Care - Patient Care 5: Diagnosis and Management in the Outpatient Setting

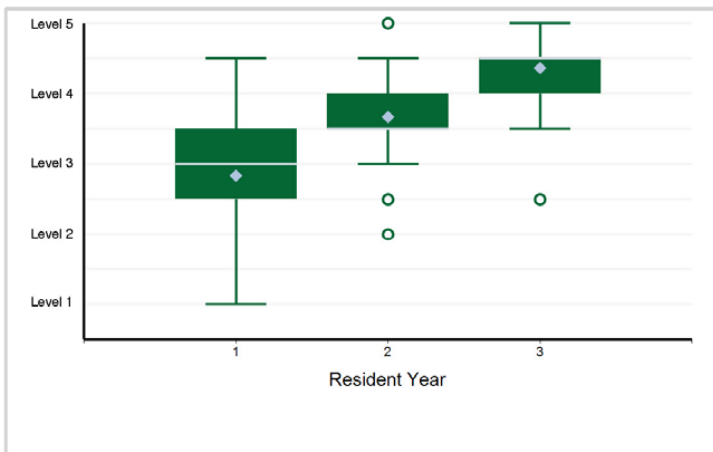

6. Patient Care - Patient Care 6: Neuroimaging

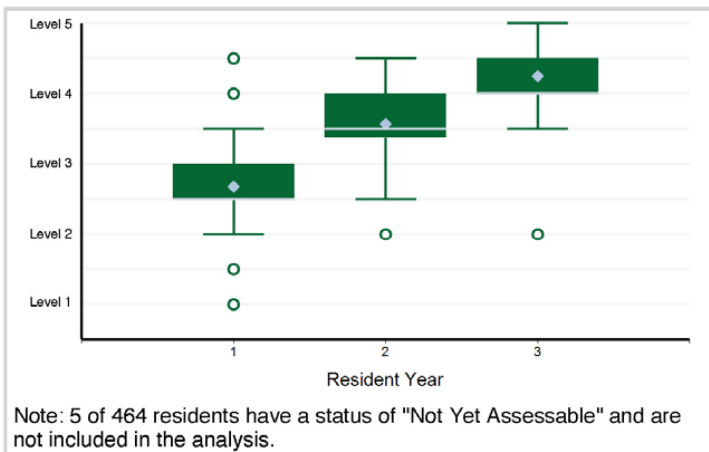

Specialty Box Plot Report - Milestone Evaluation by Resident Year: Year-End 2021-2022

SPECIALTY: Child Neurology

7. Patient Care - Patient Care 7: Electroencephalogram (EEG)

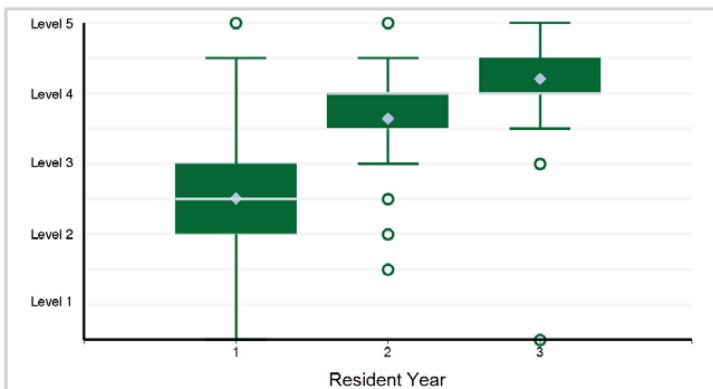

Note: 12 of 464 residents have a status of "Not Yet Assessable" and are not included in the analysis.

8. Patient Care - Patient Care 8: Lumbar Puncture

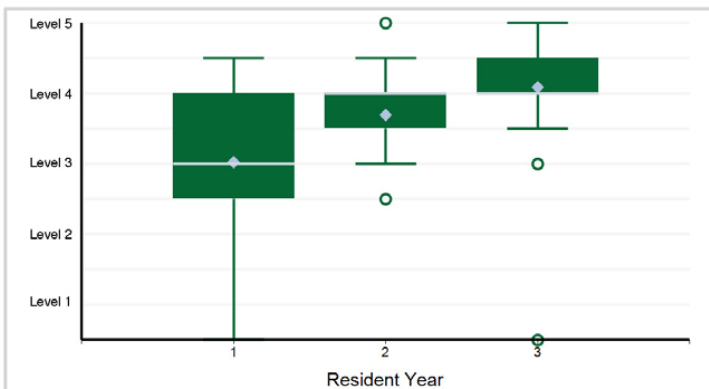

Note: 26 of 464 residents have a status of "Not Yet Assessable" and are not included in the analysis.

9. Patient Care - Patient Care 9: Electromyography

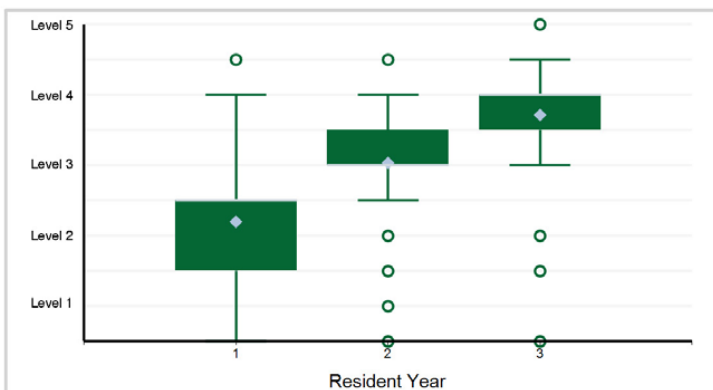

Note: 60 of 464 residents have a status of "Not Yet Assessable" and are not included in the analysis.

10. Patient Care - Patient Care 10: Determination of Death by Neurologic Criteria

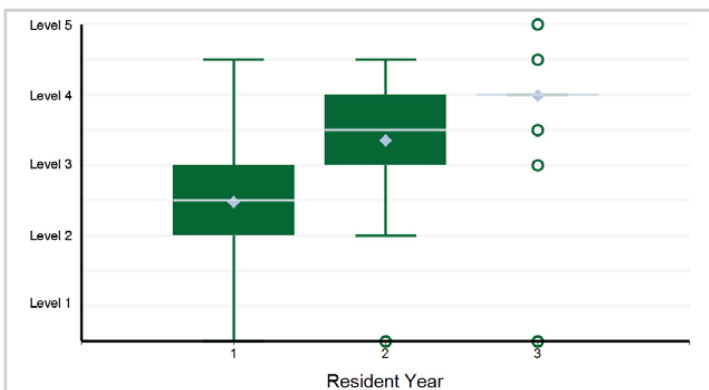

Note: 49 of 464 residents have a status of "Not Yet Assessable" and are not included in the analysis.

11. Medical Knowledge - Medical Knowledge 1: Development and Behavior

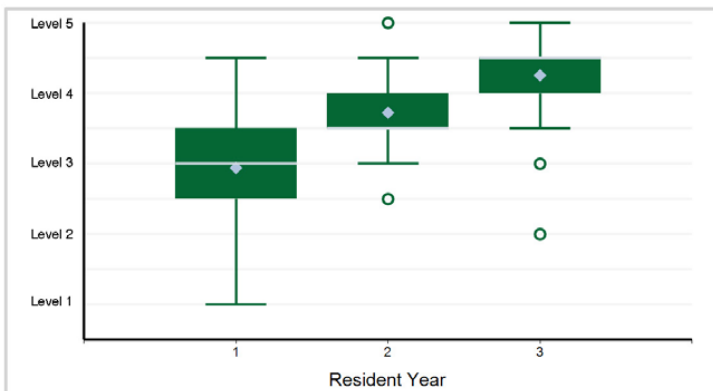

Note: 3 of 464 residents have a status of "Not Yet Assessable" and are not included in the analysis.

12. Medical Knowledge - Medical Knowledge 2: Localization

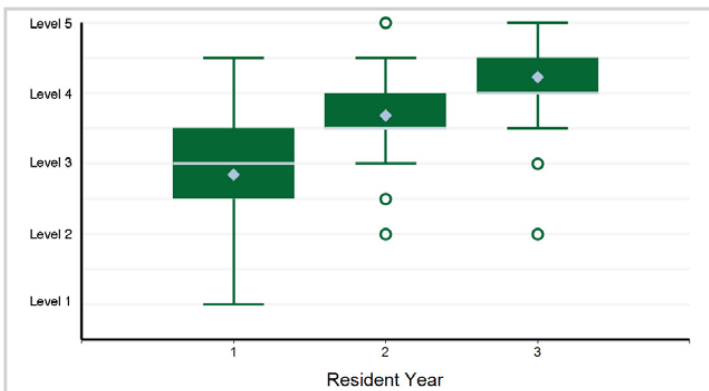

Note: 2 of 464 residents have a status of "Not Yet Assessable" and are not included in the analysis.

Specialty Box Plot Report - Milestone Evaluation by Resident Year: Year-End 2021-2022

SPECIALTY: Child Neurology

13. Medical Knowledge - Medical Knowledge 3: Clinical Reasoning and Formulation

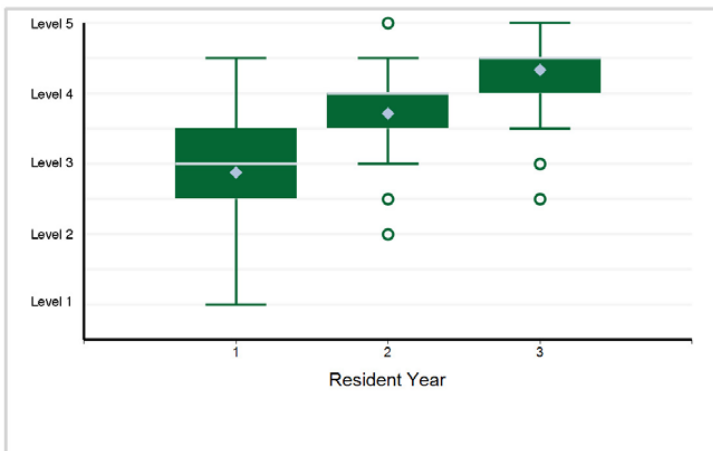

14. Medical Knowledge - Medical Knowledge 4: Diagnostic Investigation

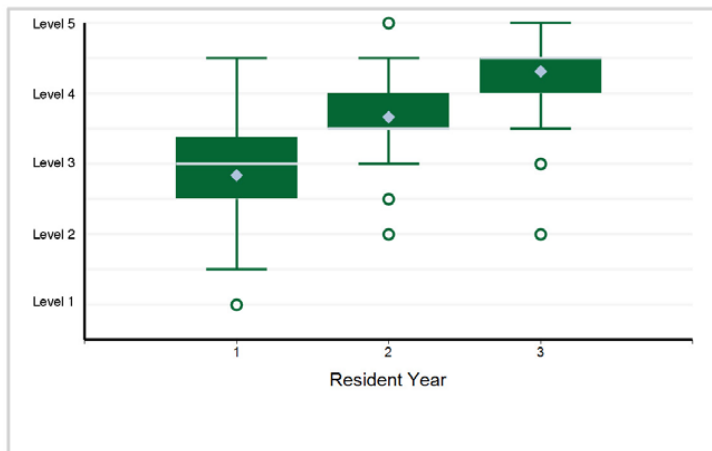

15. Systems-Based Practice - Systems-Based Practice 1: Patient Safety and Quality Improvement

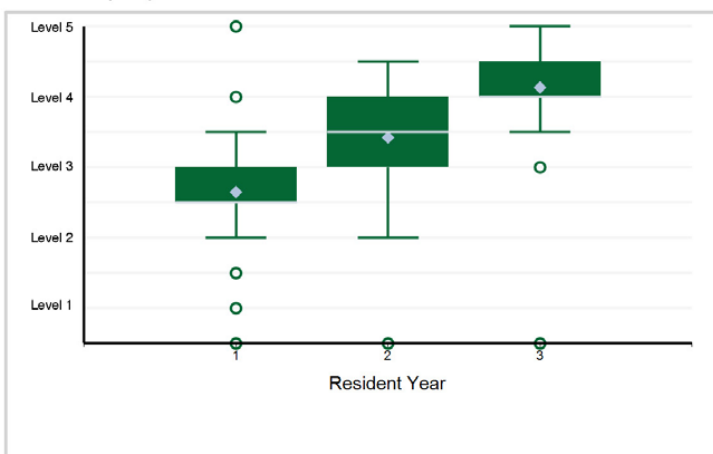

16. Systems-Based Practice - Systems-Based Practice 2: System Navigation for Patient-Centered Care

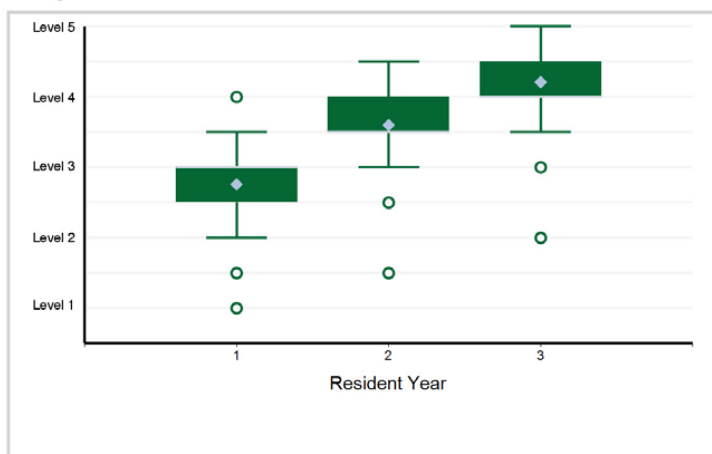

17. Systems-Based Practice - Systems-Based Practice 3: Physician Role in Health Care Systems

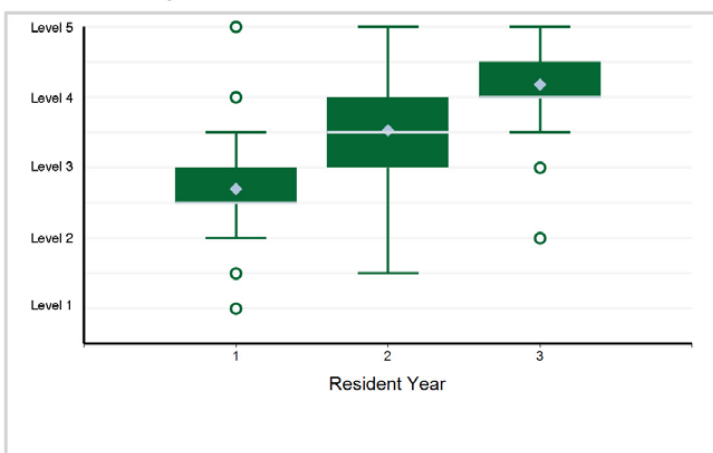

18. Practice-Based Learning and Improvement - Practice-Based Learning and Improvement 1: Evidence-Based and Informed Practice

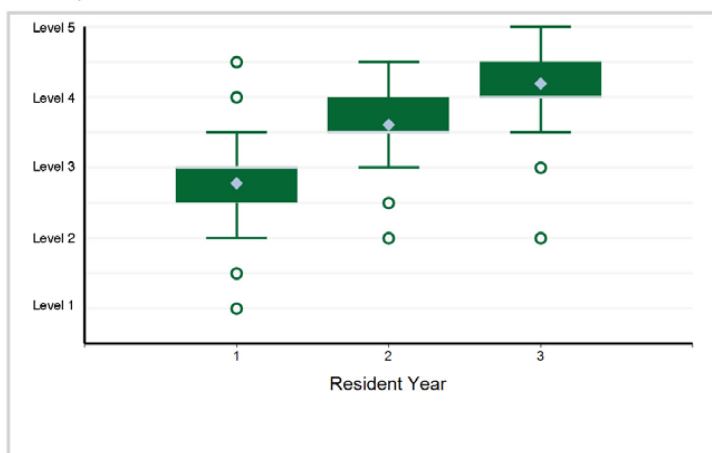

Specialty Box Plot Report - Milestone Evaluation by Resident Year: Year-End 2021-2022

SPECIALTY: Child Neurology

19. Practice-Based Learning and Improvement - Practice-Based Learning and Improvement 2: Reflective Practice and Commitment ...

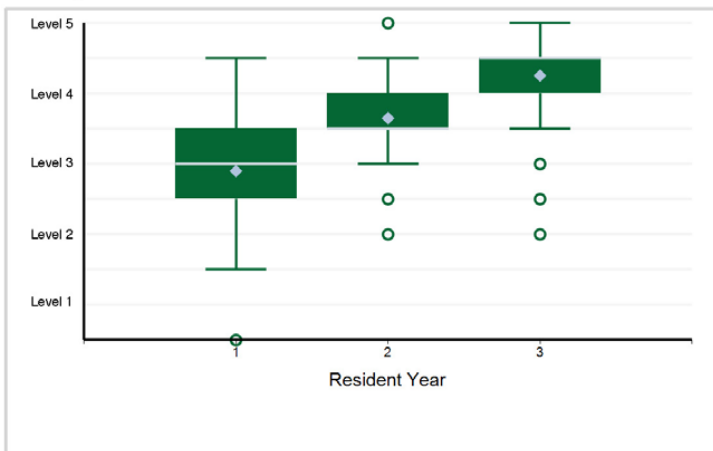

20. Professionalism - Professionalism 1: Professional Behavior and Ethical Principles

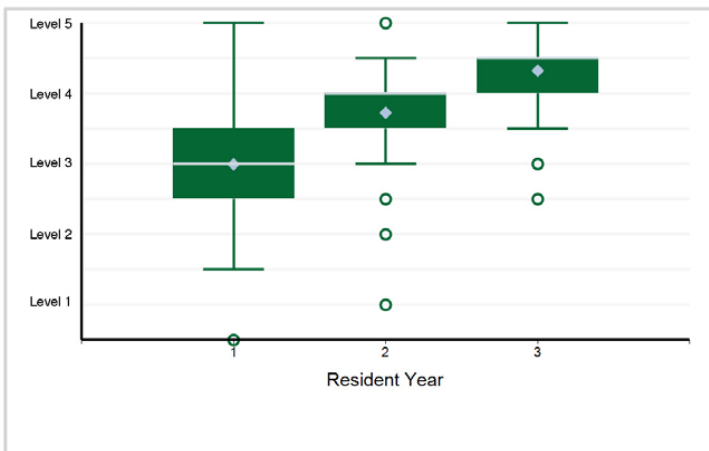

21. Professionalism - Professionalism 2: Accountability/Conscientiousness

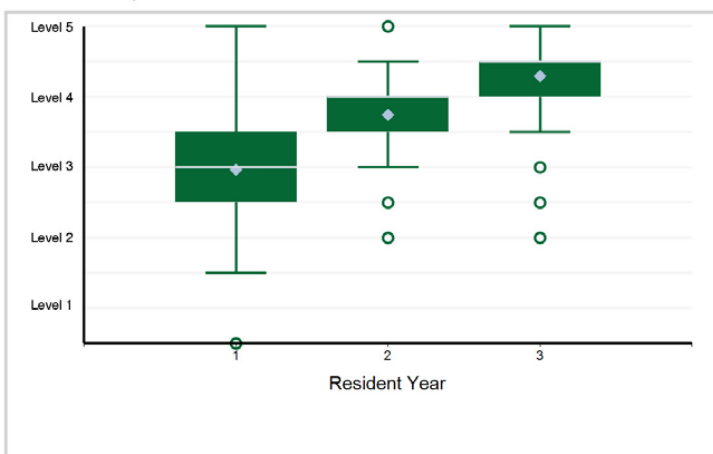

22. Professionalism - Professionalism 3: Self-Awareness and Well-Being

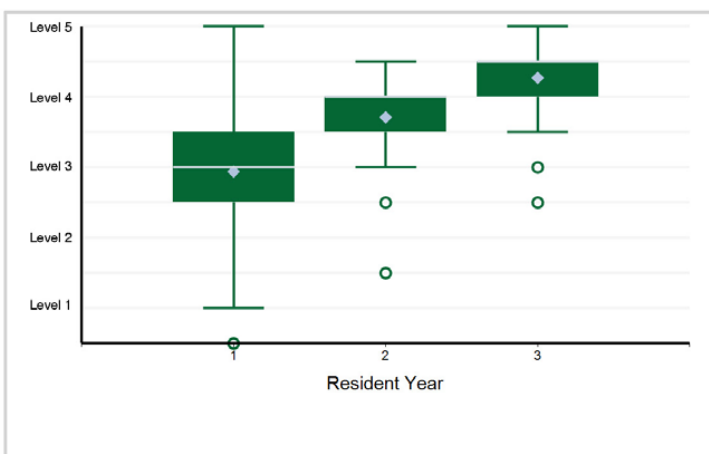

23. Interpersonal and Communication Skills - Interpersonal and Communication Skills 1: Patient- and Family-Centered Communication

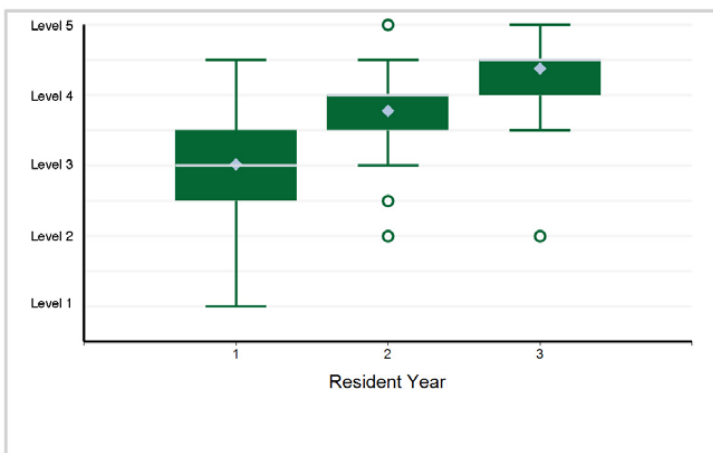

24. Interpersonal and Communication Skills - Interpersonal and Communication Skills 2: Patient and Family Education

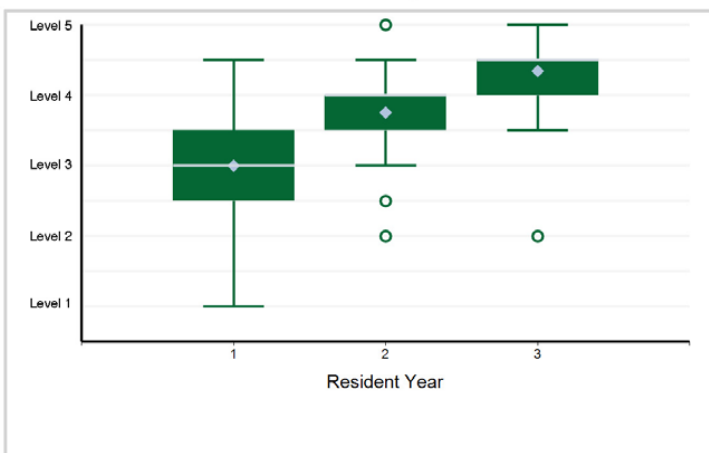

Specialty Box Plot Report - Milestone Evaluation by Resident Year: Year-End 2021-2022

SPECIALTY: Child Neurology

25. Interpersonal and Communication Skills - Interpersonal and Communication Skills 3: Interprofessional and Team Communication

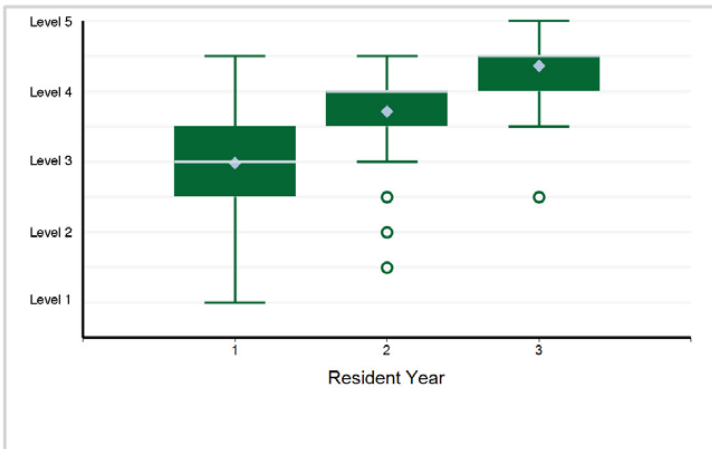

26. Interpersonal and Communication Skills - Interpersonal and Communication Skills 4: Communication within Health Care Systems

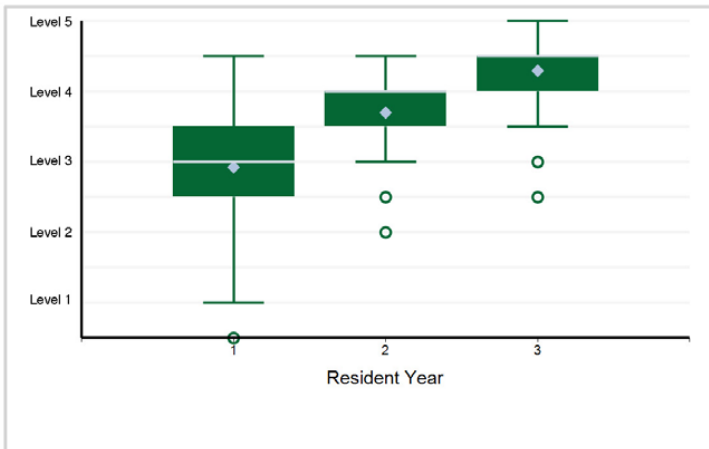

Specialty Box Plot Report - Milestone Evaluation by Resident Year: Year-End 2021-2022

TABLE 62: SPECIALTY: Nuclear Medicine

Resident Year	1	2	3	Total Residents*
# of Residents	38	20	18	76

*Note: There are 3 residents with an incomplete milestone evaluation that are excluded from the box plots below.

1. Patient Care - Diagnostic: General Nuclear Medicine, Cardiovascular, and Molecular Imaging (Patient ...

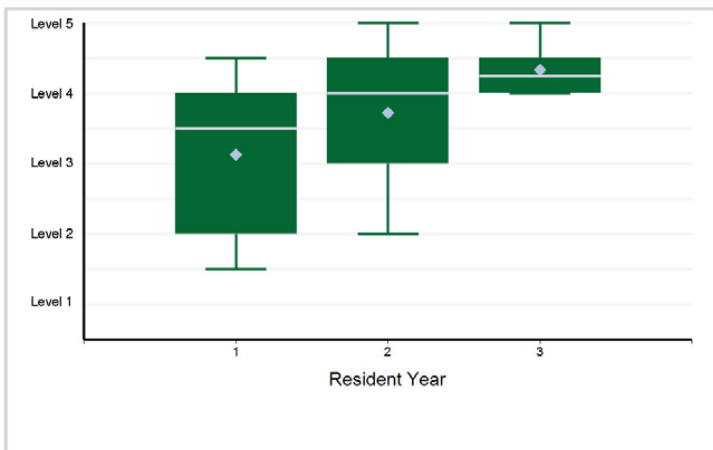

2. Patient Care - Cardiovascular Nuclear Medicine-Stress Testing: Patient Evaluation and Procedure Monitoring—Patient Care

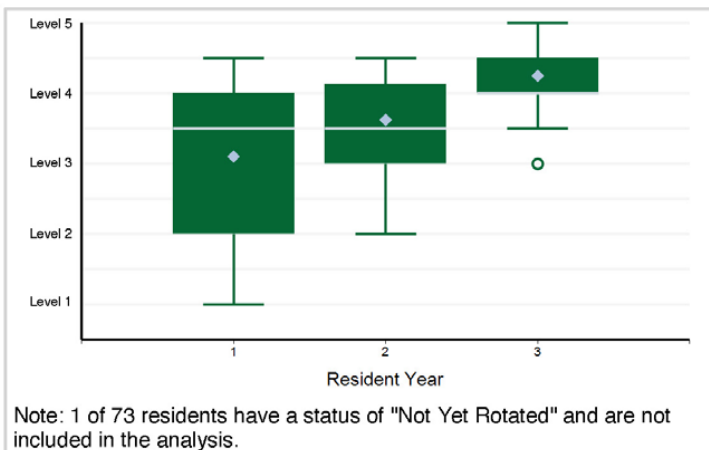

Note: 1 of 73 residents have a status of "Not Yet Rotated" and are not included in the analysis.

3. Patient Care - Therapy: Radioiodine for Benign Thyroid Disease-Patient Evaluation, Procedure Selection, ...

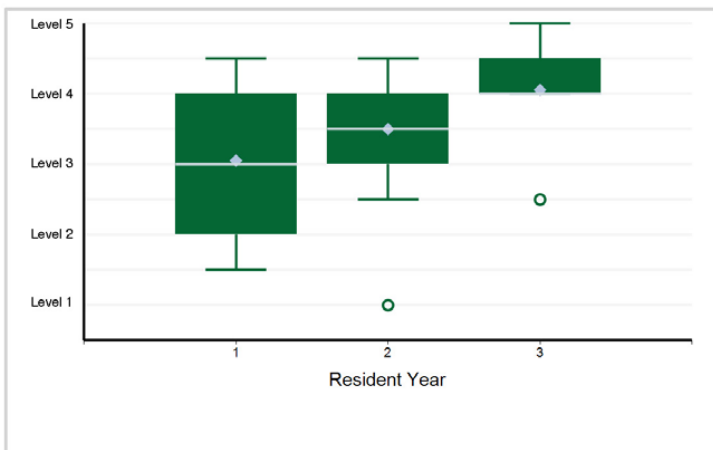

4. Patient Care - Therapy: Radioiodine for Thyroid Malignancy—Patient Evaluation, Procedure Selection, ...

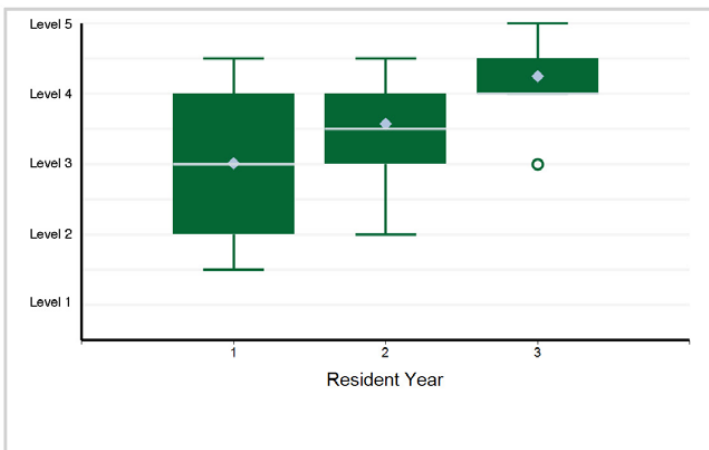

5. Patient Care - Therapy: Parenteral—Patient Evaluation, Procedure Selection, Procedure Performance, and ...

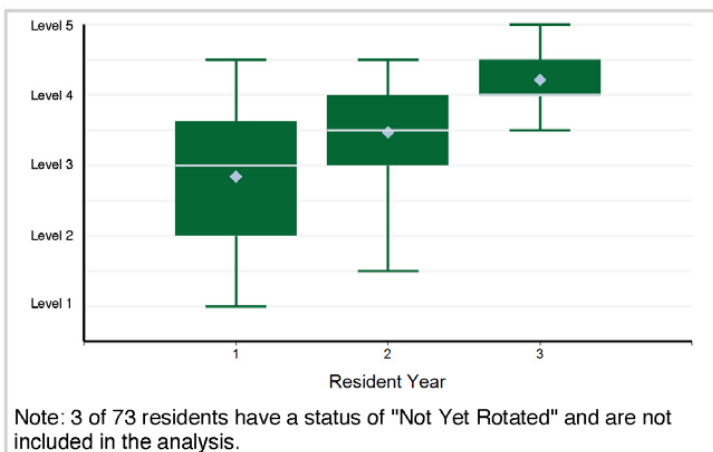

6. Medical Knowledge - Physiology and Pathophysiology—Medical Knowledge

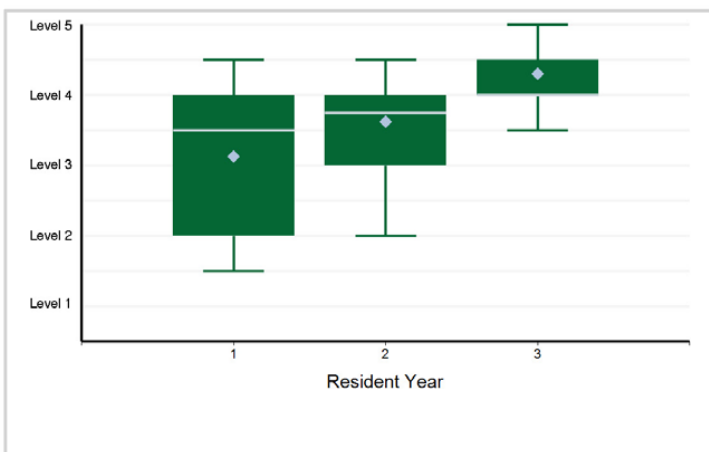

Note: 3 of 73 residents have a status of "Not Yet Rotated" and are not included in the analysis.

Specialty Box Plot Report - Milestone Evaluation by Resident Year: Year-End 2021-2022

SPECIALTY: Nuclear Medicine

7. Medical Knowledge - Anatomic Imaging—Medical Knowledge

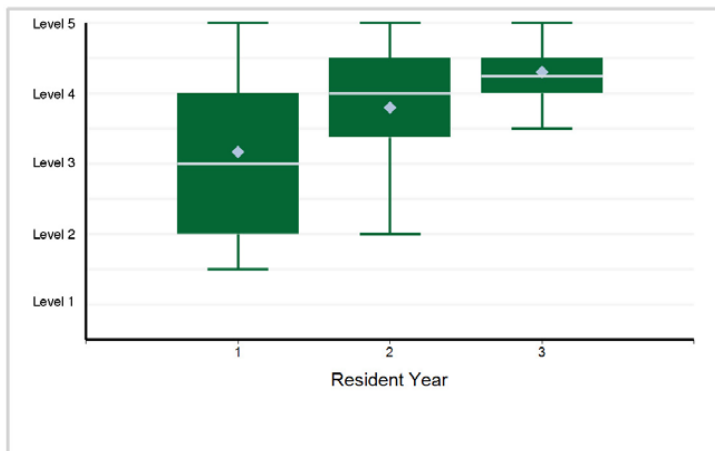

8. Medical Knowledge - Instrumentation—Medical Knowledge

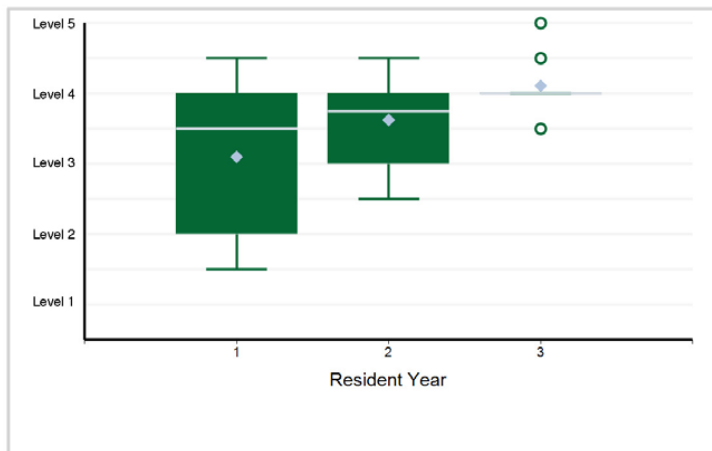

9. Medical Knowledge - Radiopharmaceuticals and molecular agents—Medical Knowledge

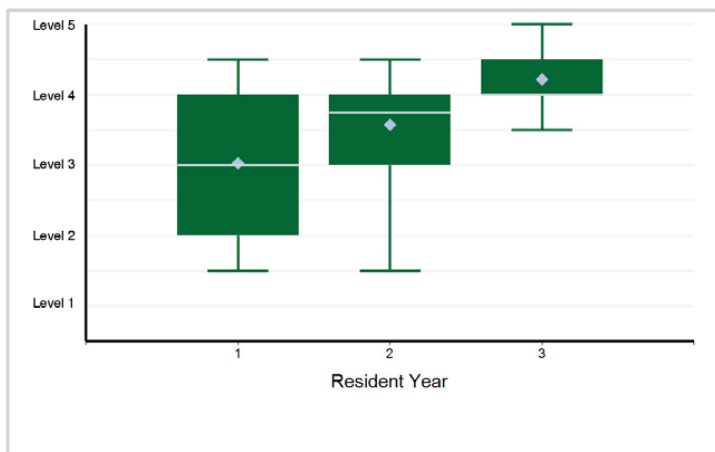

10. Medical Knowledge - Medical physics, mathematics, and radiation biology—Medical Knowledge

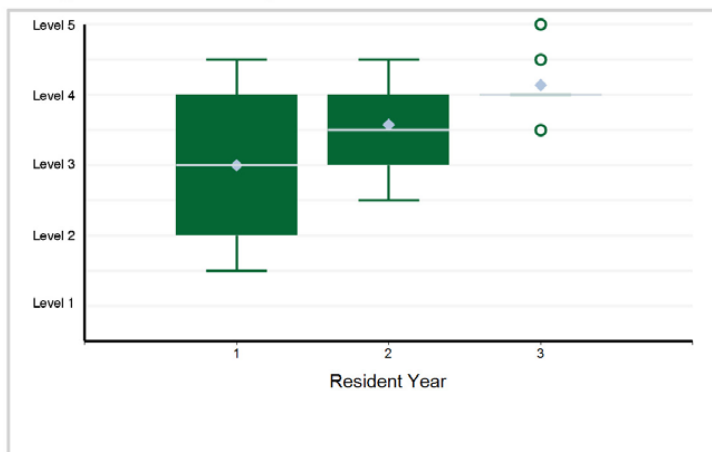

11. Medical Knowledge - Regulatory Requirements—Medical Knowledge

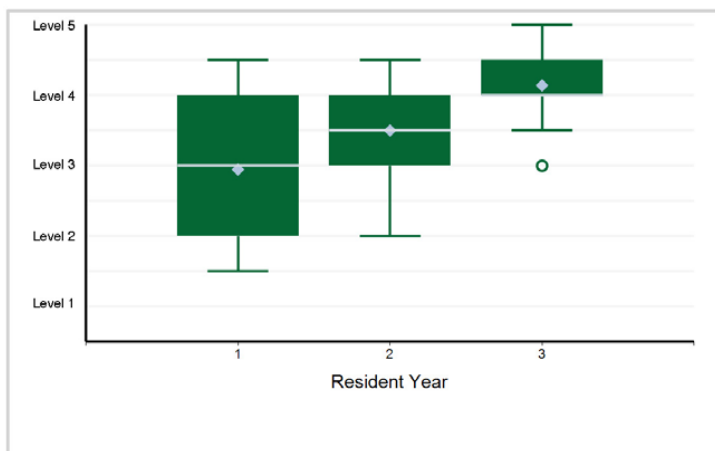

12. Medical Knowledge - Radiation Protection, Patient Safety, and Procedural Safety—Medical Knowledge

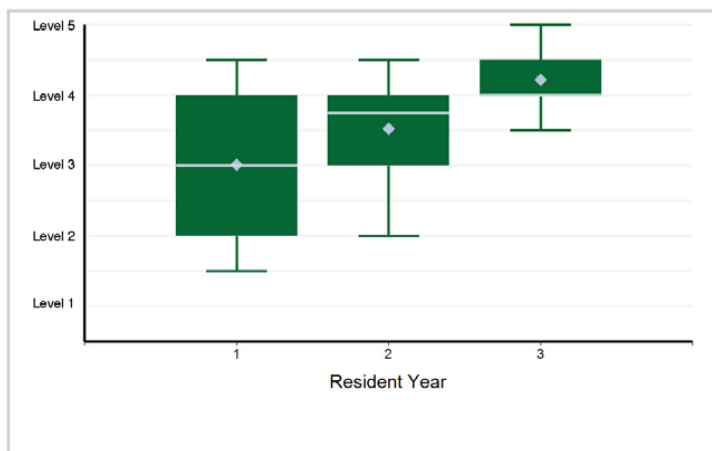

Specialty Box Plot Report - Milestone Evaluation by Resident Year: Year-End 2021-2022

SPECIALTY: Nuclear Medicine

13. Systems-Based Practice - Computer Systems—Systems-Based Practice

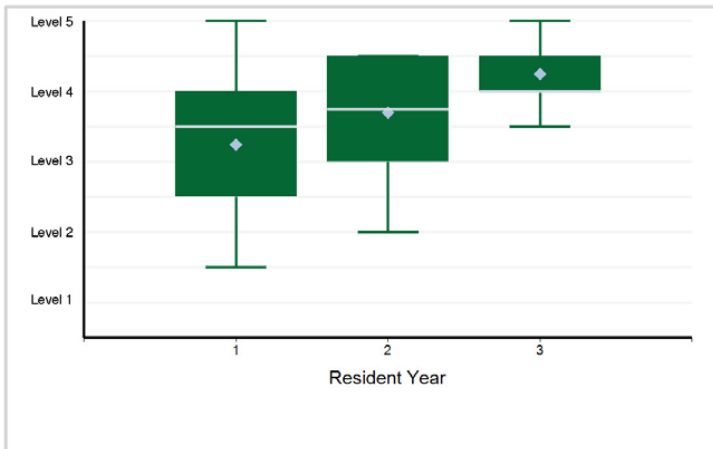

14. Systems-Based Practice - Economics—Systems-Based Practice

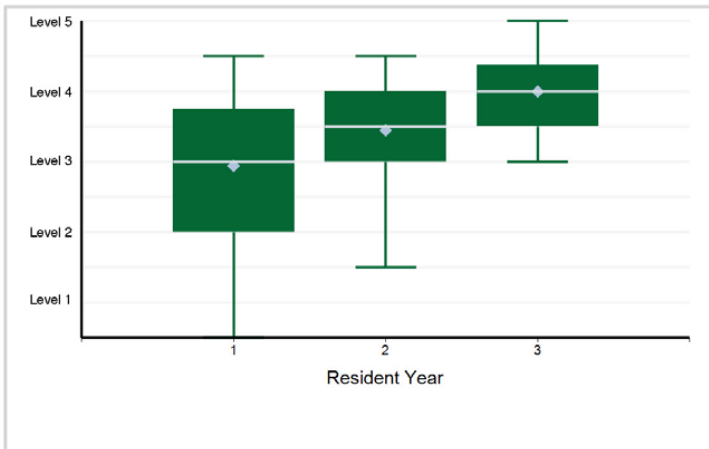

15. Practice-Based Learning and Improvement - Self-Directed Learning and Understanding Scientific Studies—Practice-Based ...

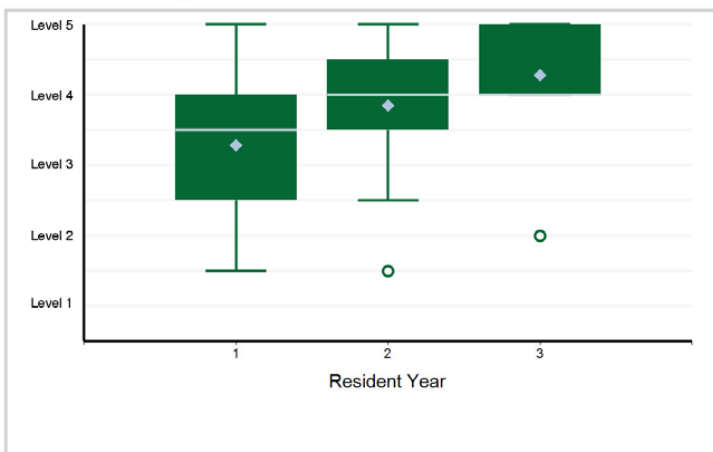

16. Practice-Based Learning and Improvement - Implements Quality Improvement Project—Practice-Based Learning and Improvement

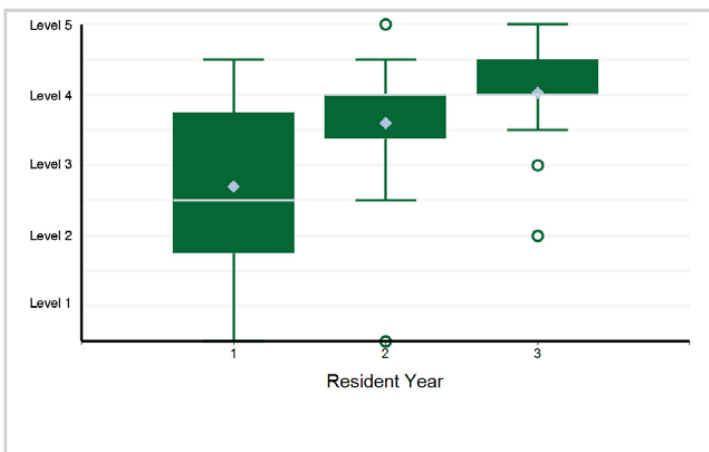

17. Professionalism - Professional Ethics and Accountability—Professionalism

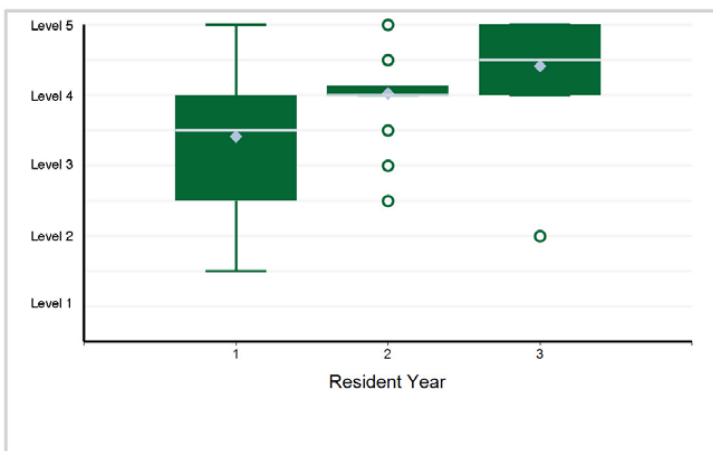

18. Interpersonal and Communication Skills - Patient Communications—Interpersonal and Communications Skills

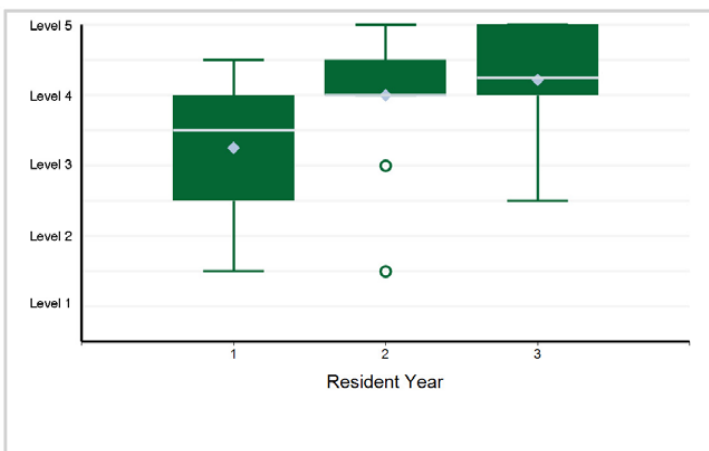

Specialty Box Plot Report - Milestone Evaluation by Resident Year: Year-End 2021-2022

SPECIALTY: **Nuclear Medicine**

19. Interpersonal and Communication Skills - Health Care Team—Interpersonal and Communications Skills

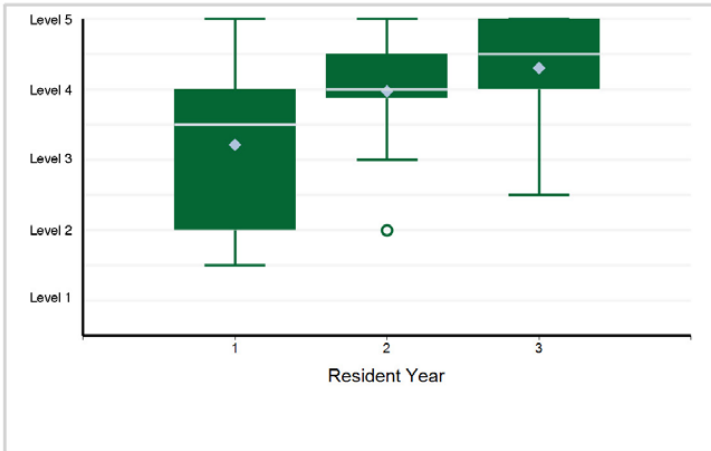

Specialty Box Plot Report - Milestone Evaluation by Resident Year: Year-End 2021-2022

TABLE 63: SPECIALTY: **Obstetrics and Gynecology**

Resident Year	1	2	3	4	Total Residents*
# of Residents	1,528	1,496	1,441	1,423	5,888

*Note: There are 1 residents with an incomplete milestone evaluation that are excluded from the box plots below.

1. Patient Care - Antepartum Care and Complications of Pregnancy—Patient Care

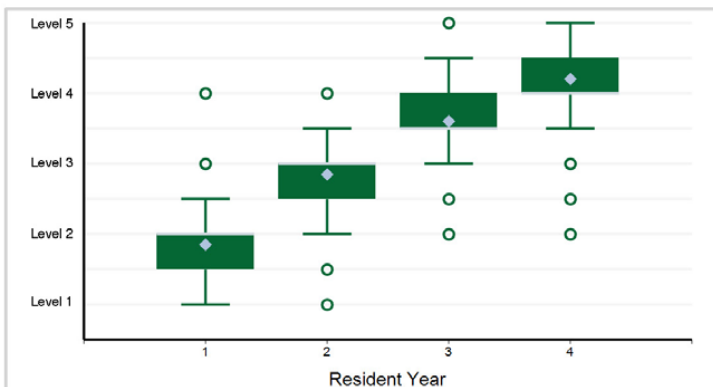

Note: 17 of 5,887 residents have a status of "Not Yet Rotated" and are not included in the analysis.

2. Patient Care - Care of Patients in the Intrapartum Period—Patient Care

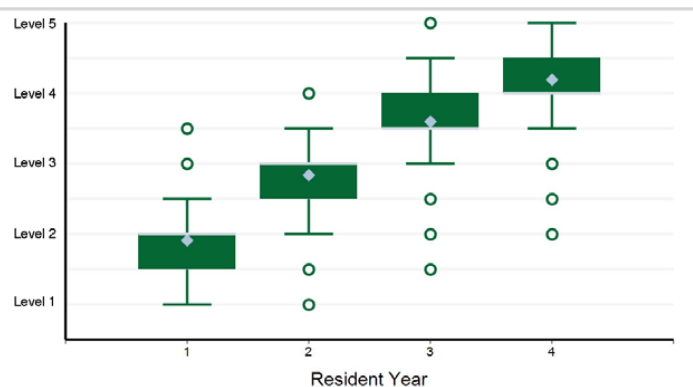

Note: 7 of 5,887 residents have a status of "Not Yet Rotated" and are not included in the analysis.

3. Patient Care - Care of Patients in the Postpartum Period—Patient Care

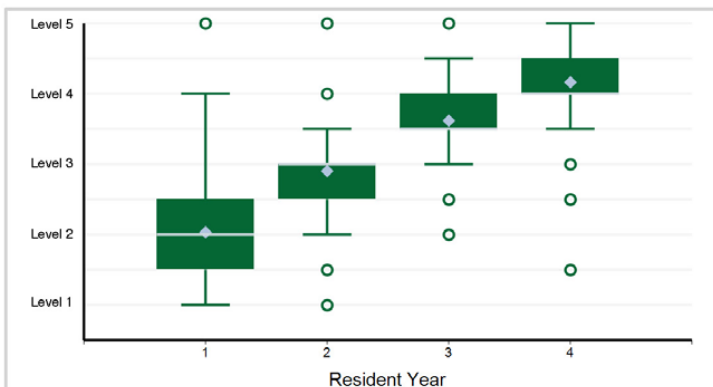

Note: 11 of 5,887 residents have a status of "Not Yet Rotated" and are not included in the analysis.

4. Patient Care - Obstetrical Technical Skills—Patient Care

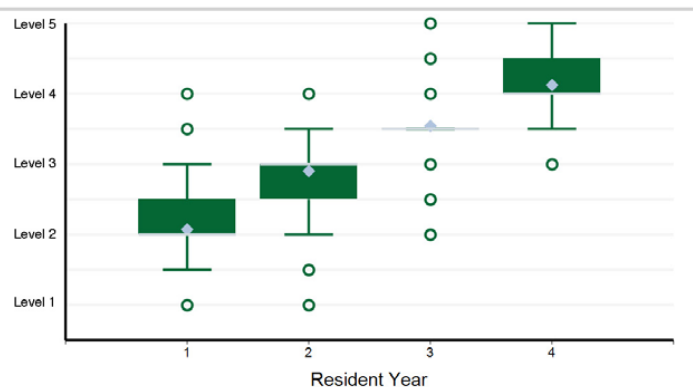

Note: 5 of 5,887 residents have a status of "Not Yet Rotated" and are not included in the analysis.

5. Patient Care - Immediate Care of the Newborn—Patient Care

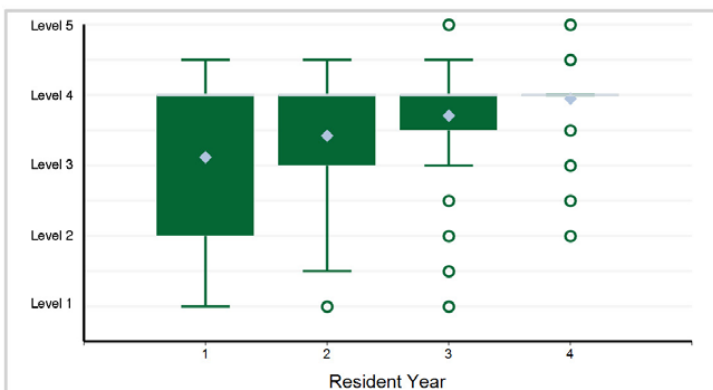

Note: 137 of 5,887 residents have a status of "Not Yet Rotated" and are not included in the analysis.

6. Patient Care - Gynecology Technical Skills: Laparotomy (e.g., Hysterectomy, Myomectomy, Adnexectomy)—Patient Care

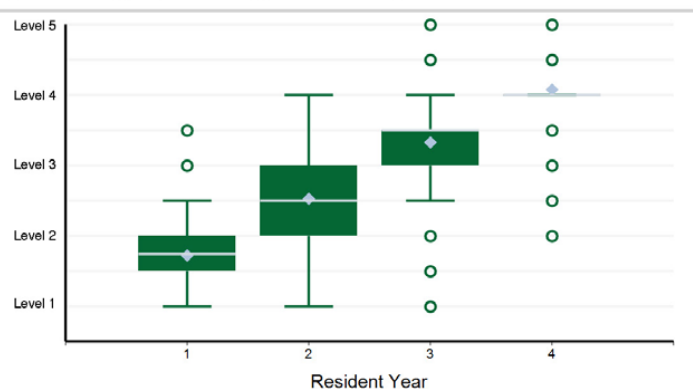

Note: 145 of 5,887 residents have a status of "Not Yet Rotated" and are not included in the analysis.

Specialty Box Plot Report - Milestone Evaluation by Resident Year: Year-End 2021-2022

SPECIALTY: Obstetrics and Gynecology

7. Patient Care - Gynecology Technical Skills: Vaginal Surgery (e.g., Vaginal Hysterectomy, Colporrhaphy, ...)

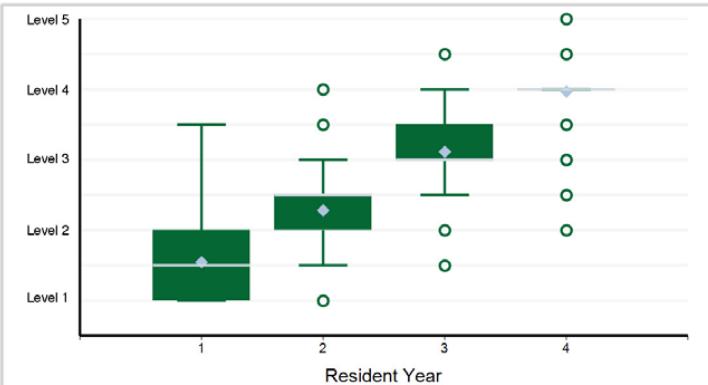

Note: 478 of 5,887 residents have a status of "Not Yet Rotated" and are not included in the analysis.

8. Patient Care - Gynecology Technical Skills: Endoscopy (Laparoscopy, Hysteroscopy, Cystoscopy)—Patient Care

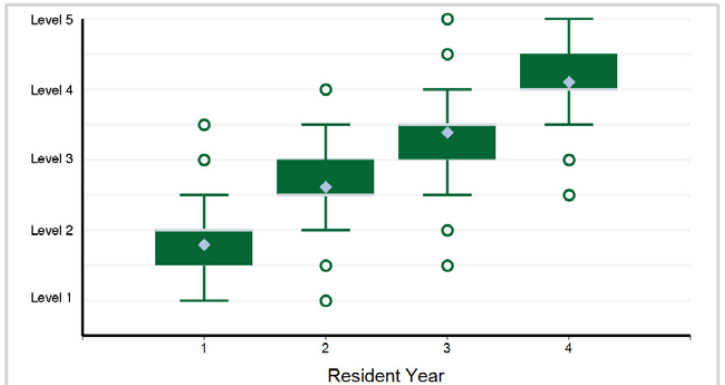

Note: 52 of 5,887 residents have a status of "Not Yet Rotated" and are not included in the analysis.

9. Patient Care - Family Planning—Patient Care

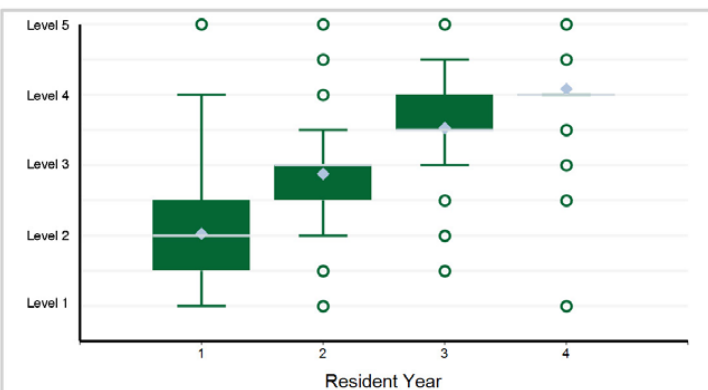

Note: 63 of 5,887 residents have a status of "Not Yet Rotated" and are not included in the analysis.

10. Patient Care - Ambulatory Gynecology—Patient Care

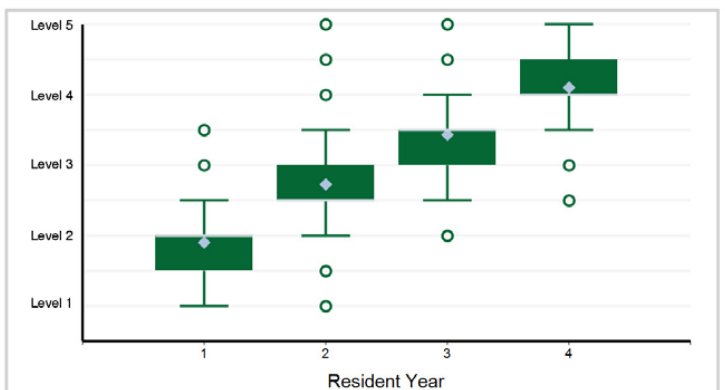

Note: 46 of 5,887 residents have a status of "Not Yet Rotated" and are not included in the analysis.

11. Patient Care - Care of the Patient with Non-Reproductive Medical Disorders—Patient Care

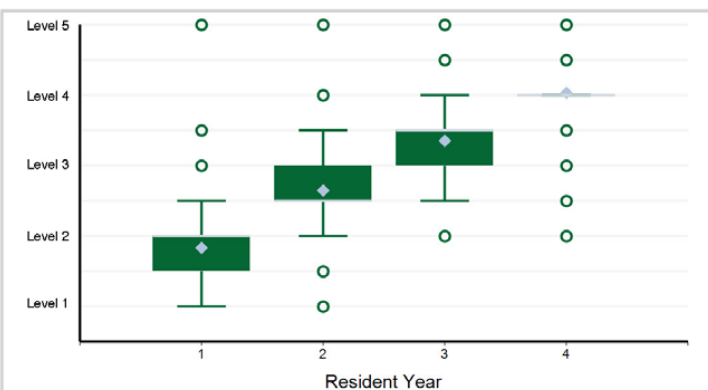

Note: 30 of 5,887 residents have a status of "Not Yet Rotated" and are not included in the analysis.

12. Medical Knowledge - Perioperative Care—Medical Knowledge

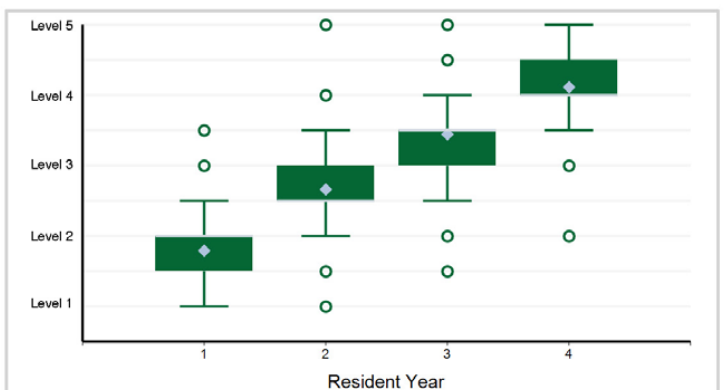

Note: 17 of 5,887 residents have a status of "Not Yet Rotated" and are not included in the analysis.

Specialty Box Plot Report - Milestone Evaluation by Resident Year: Year-End 2021-2022

SPECIALTY: Obstetrics and Gynecology

13. Medical Knowledge - Abdominal/Pelvic Pain (Acute and Chronic)—Medical Knowledge

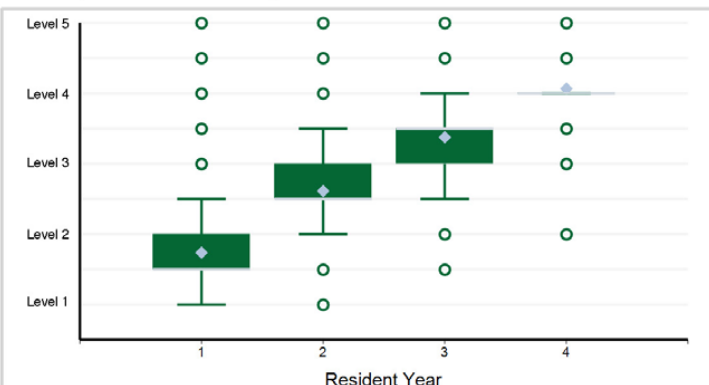

Note: 38 of 5,887 residents have a status of "Not Yet Rotated" and are not included in the analysis.

14. Medical Knowledge - Abnormal Uterine Bleeding (Acute and Chronic)—Medical Knowledge

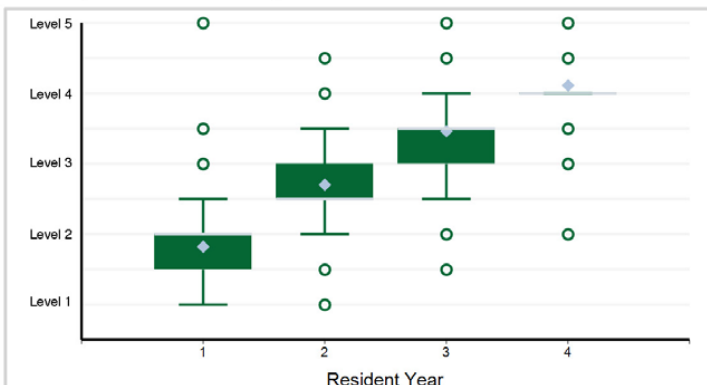

Note: 16 of 5,887 residents have a status of "Not Yet Rotated" and are not included in the analysis.

15. Medical Knowledge - Pelvic Mass—Medical Knowledge

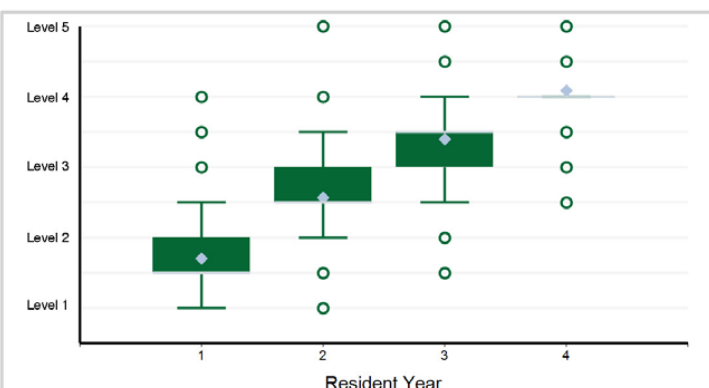

Note: 80 of 5,887 residents have a status of "Not Yet Rotated" and are not included in the analysis.

16. Medical Knowledge - Pelvic Floor Disorders (Urinary Incontinence, Pelvic Prolapse, Anal Incontinence)—Medical Knowledge

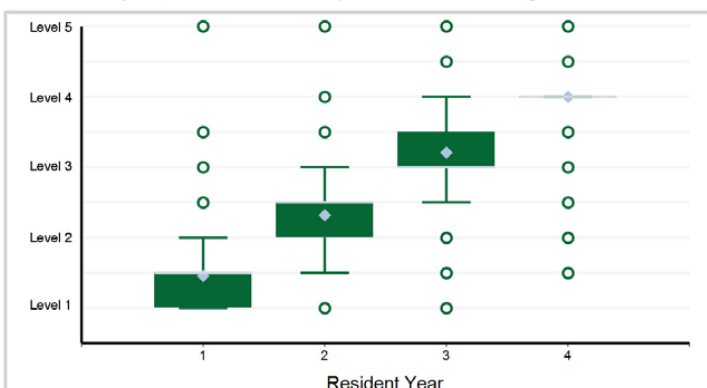

Note: 606 of 5,887 residents have a status of "Not Yet Rotated" and are not included in the analysis.

17. Medical Knowledge - First Trimester Bleeding—Medical Knowledge

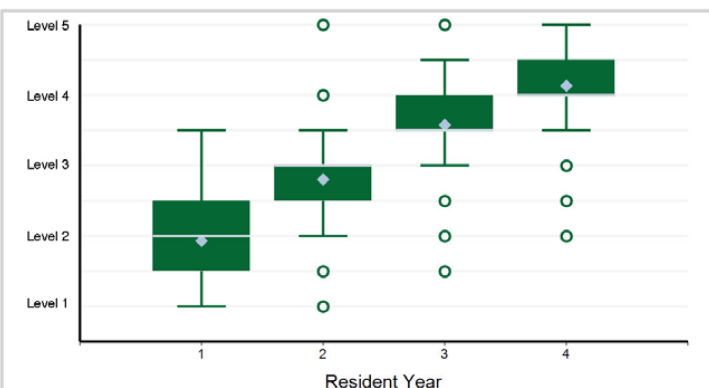

Note: 28 of 5,887 residents have a status of "Not Yet Rotated" and are not included in the analysis.

18. Medical Knowledge - Health Care Maintenance and Disease Prevention—Medical Knowledge

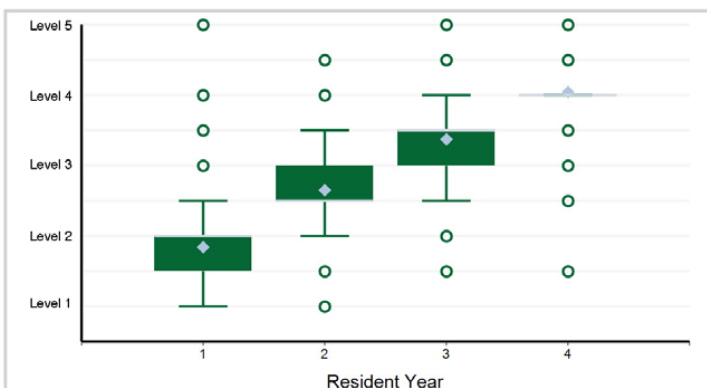

Note: 33 of 5,887 residents have a status of "Not Yet Rotated" and are not included in the analysis.

Specialty Box Plot Report - Milestone Evaluation by Resident Year: Year-End 2021-2022

SPECIALTY: Obstetrics and Gynecology

19. Systems-Based Practice - Patient Safety and Systems Approach to Medical Errors: Participate in identifying ...

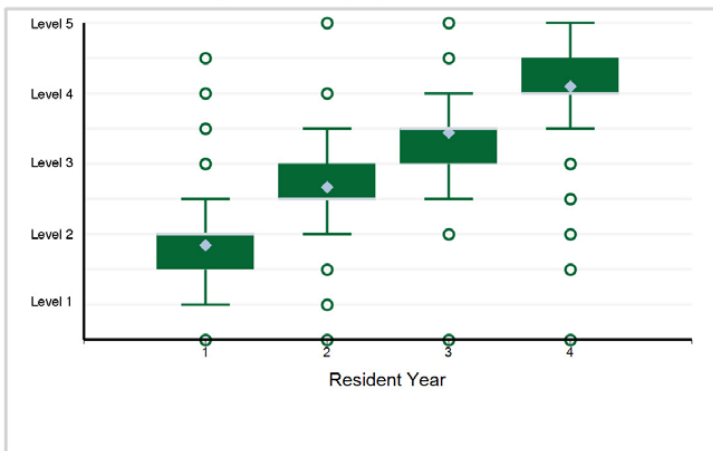

20. Systems-Based Practice - Cost-effective Care and Patient Advocacy—Systems-Based Practice

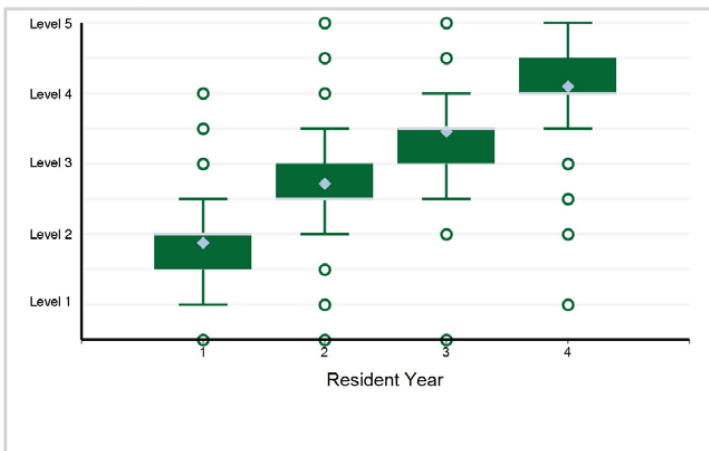

21. Practice-Based Learning and Improvement - Self-directed Learning/Critical Appraisal of Medical Literature—Practice-Based ...

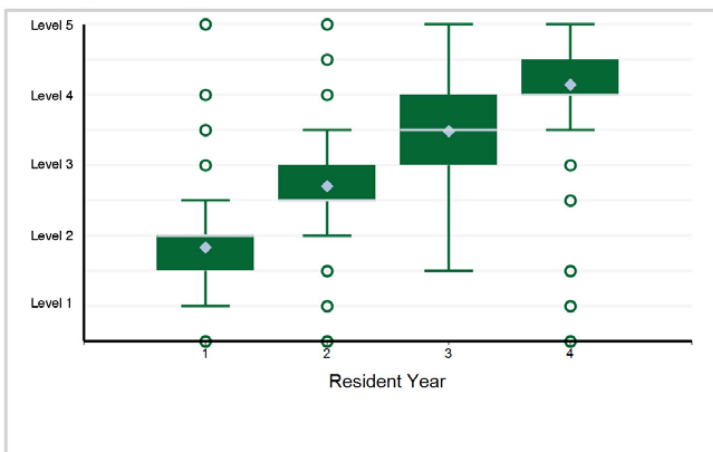

22. Practice-Based Learning and Improvement - Quality Improvement Process: Systematically analyze practice ...

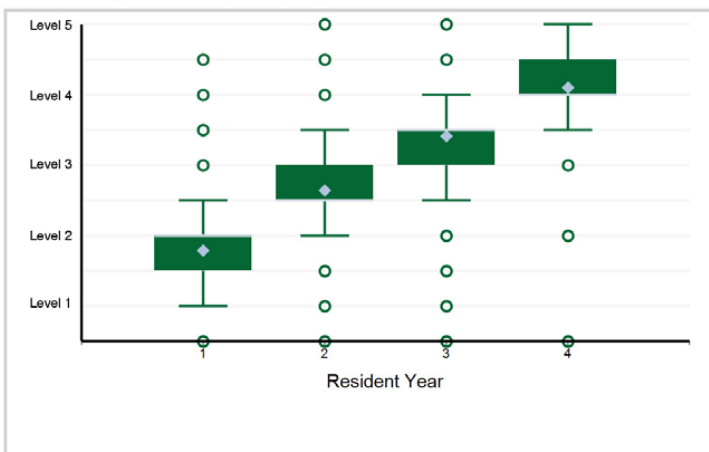

23. Professionalism - Compassion, Integrity, and Respect for Others—Professionalism

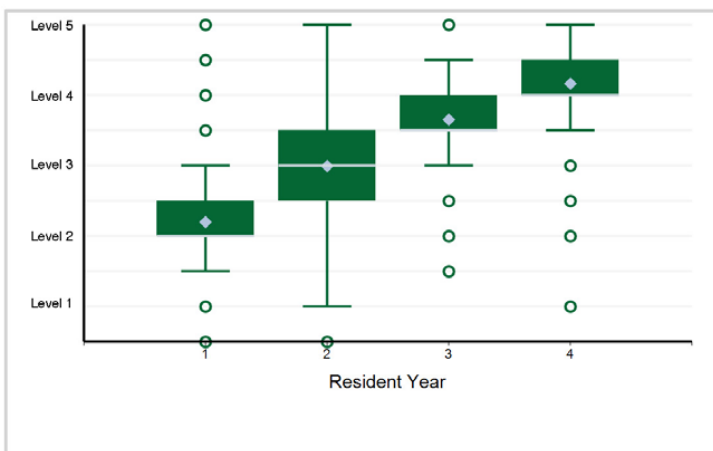

24. Professionalism - Accountability and Responsiveness to the Needs of Patients, Society, and the Profession—Professionalism

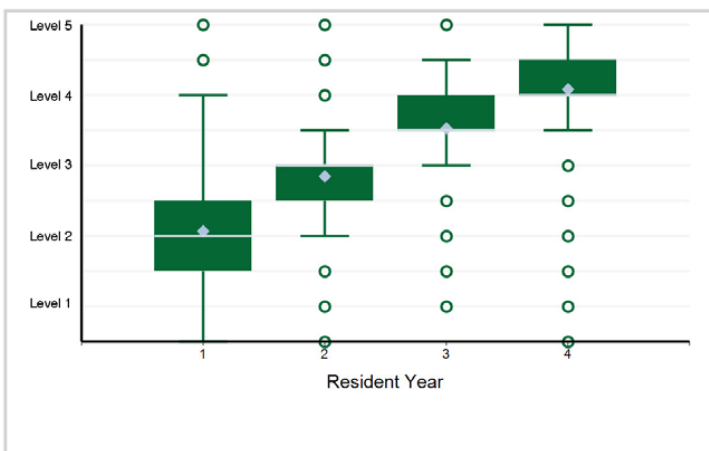

Specialty Box Plot Report - Milestone Evaluation by Resident Year: Year-End 2021-2022

SPECIALTY: Obstetrics and Gynecology

25. Professionalism - Respect for Patient Privacy, Autonomy, Patient-Physician Relationship—Professionalism

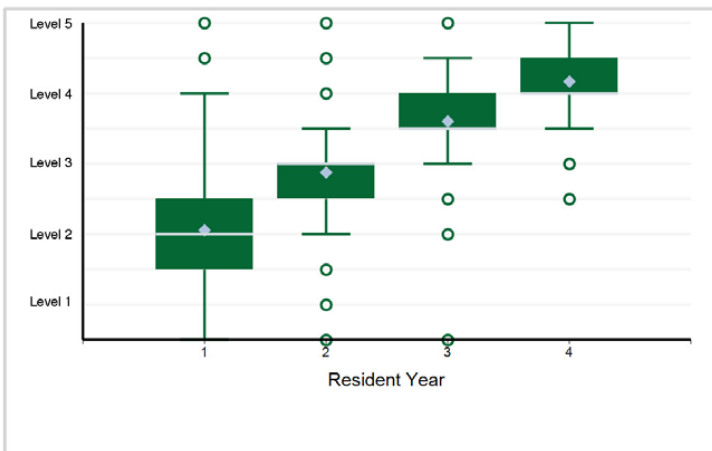

26. Interpersonal and Communication Skills - Communication with Patients and Families—Interpersonal and Communication Skills

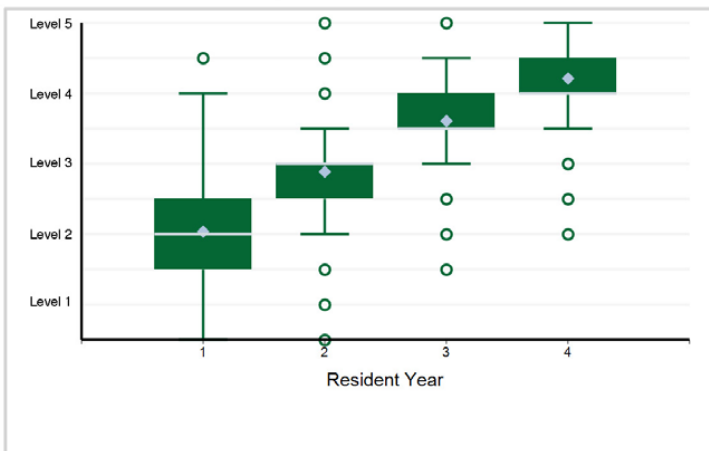

27. Interpersonal and Communication Skills - Communication with Physicians and Other Health Professionals ...

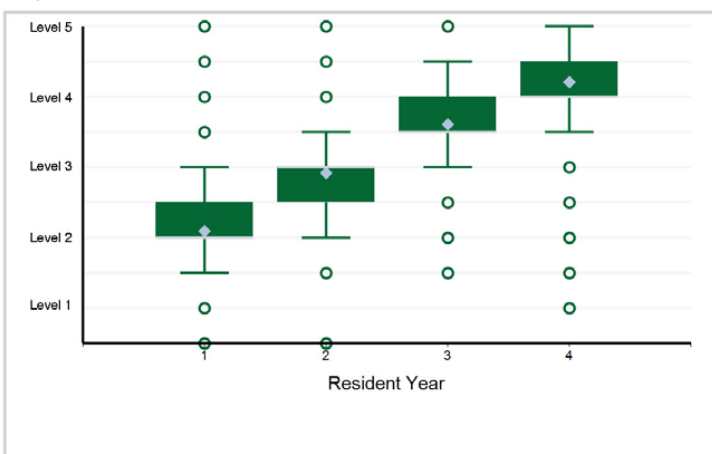

28. Interpersonal and Communication Skills - Informed Consent and Shared Decision Making—Interpersonal and Communication Skills

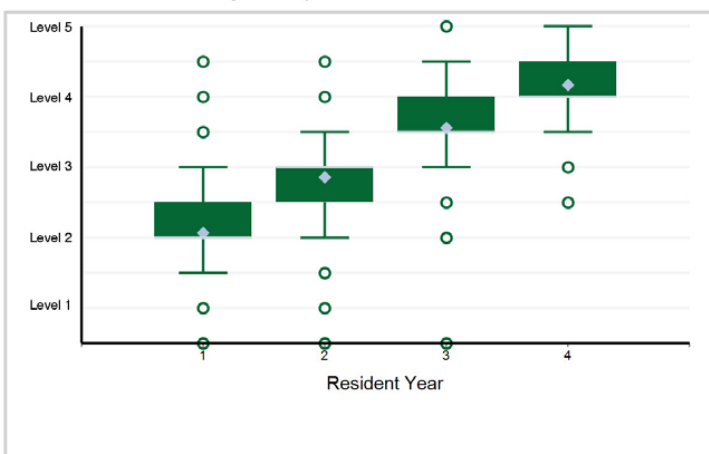

Specialty Box Plot Report - Milestone Evaluation by Resident Year: Year-End 2021-2022

TABLE 64: SUBSPECIALTY: **Female Pelvic Medicine and Reconstructive Surgery (multidisciplinary, Obstetrics and Gynecology)**

Resident Year	1	2	3	Total Residents
# of Residents	53	48	51	152

1. Patient Care - General Pelvic Floor Evaluation — Patient Care

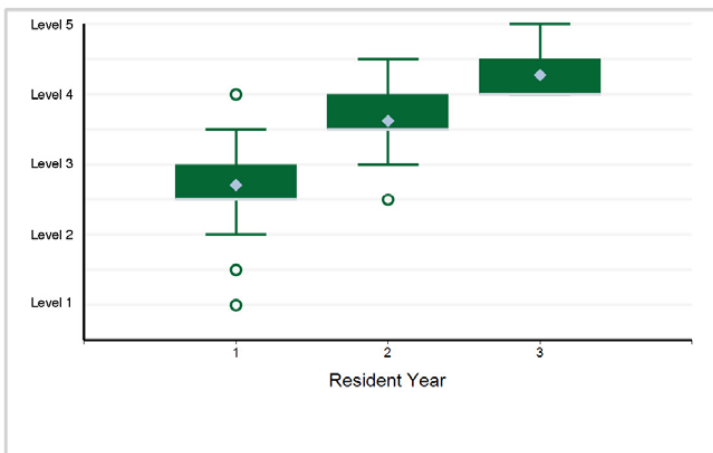

2. Patient Care - Urinary Incontinence and Overactive Bladder Treatment — Patient Care

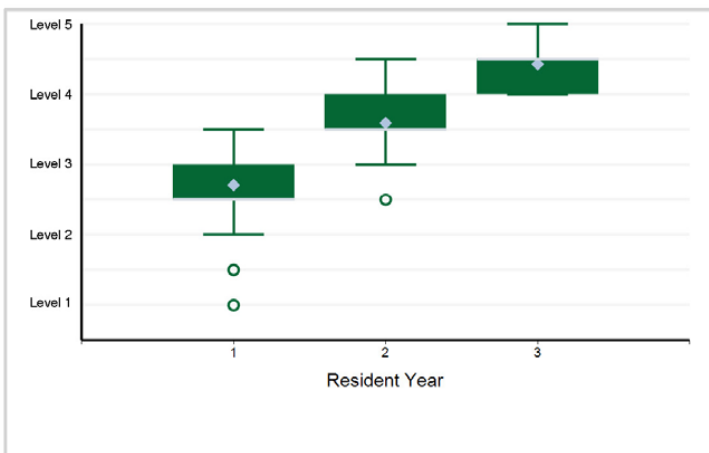

3. Patient Care - Anal Incontinence and Defecatory Dysfunction Treatment — Patient Care

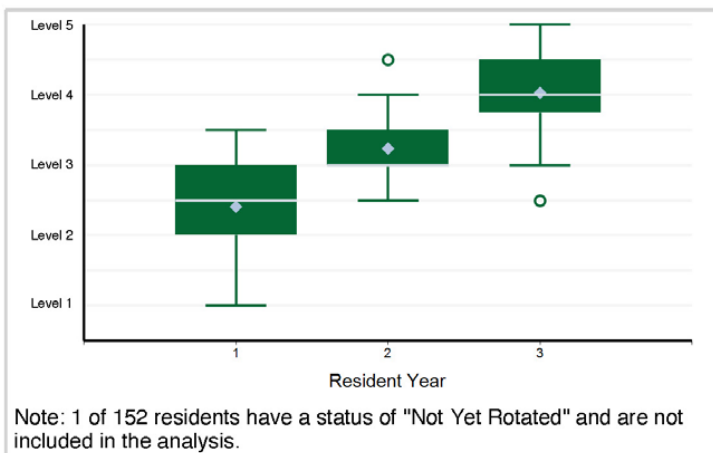

4. Patient Care - Pelvic Organ Prolapse Treatment — Patient Care

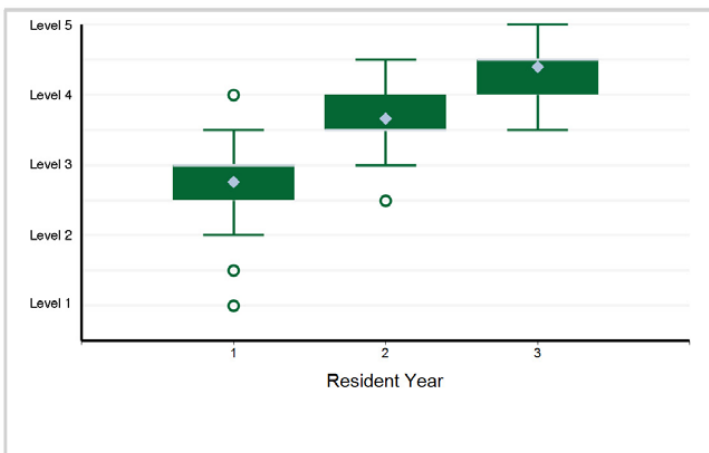

Note: 1 of 152 residents have a status of "Not Yet Rotated" and are not included in the analysis.

5. Patient Care - Urogenital Fistulas and Urethral Diverticula Treatment — Patient Care

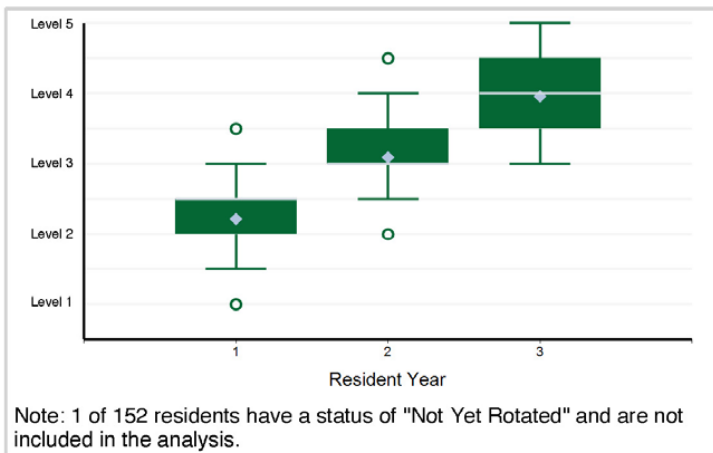

6. Patient Care - Painful Bladder Syndrome Treatment — Patient Care

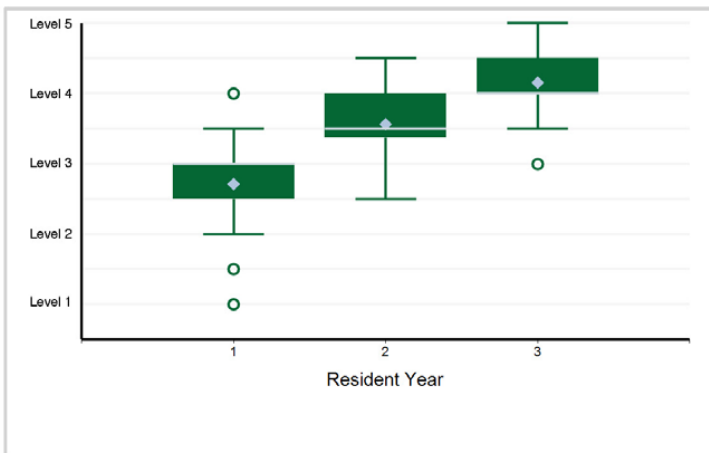

Note: 1 of 152 residents have a status of "Not Yet Rotated" and are not included in the analysis.

Specialty Box Plot Report - Milestone Evaluation by Resident Year: Year-End 2021-2022

SUBSPECIALTY: Female Pelvic Medicine and Reconstructive Surgery (multidisciplinary, Obstetrics and Gynecology)

7. Patient Care - Urinary Tract Infection (UTI) — Patient Care

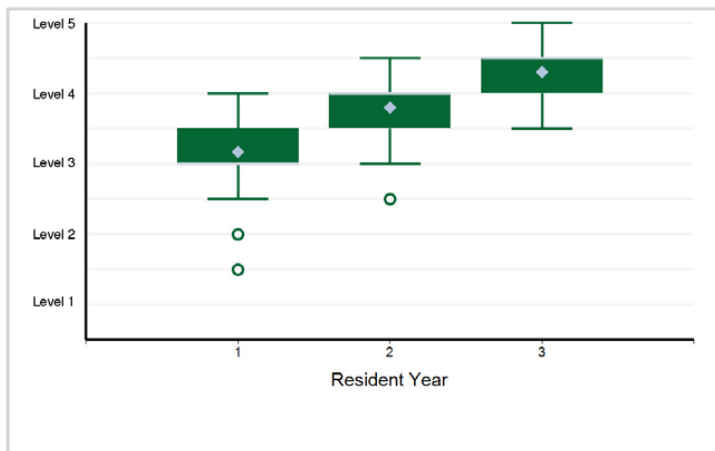

8. Medical Knowledge - Pelvic Floor Anatomy and Physiology — Medical Knowledge

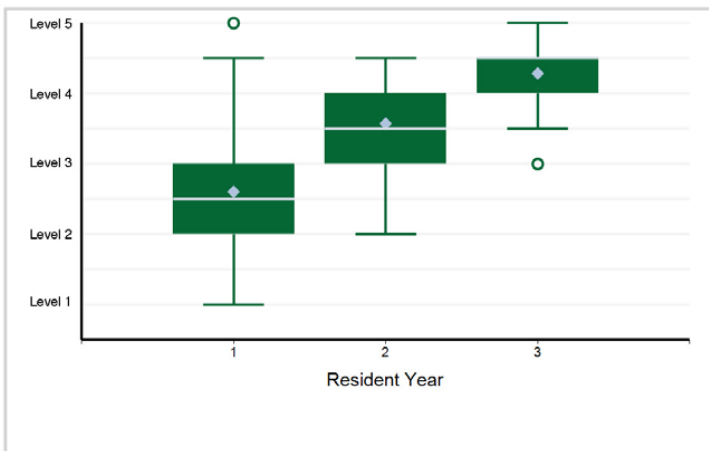

9. Medical Knowledge - Urinary Incontinence and Overactive Bladder Treatment — Medical Knowledge

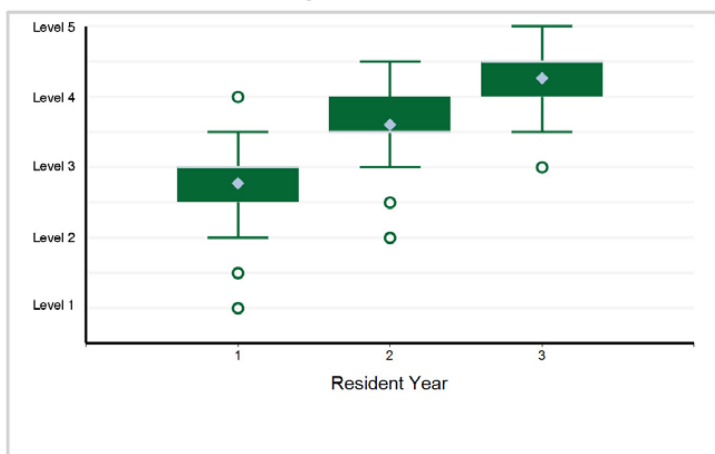

10. Medical Knowledge - Anal Incontinence and Defecatory Dysfunction Treatment — Medical Knowledge

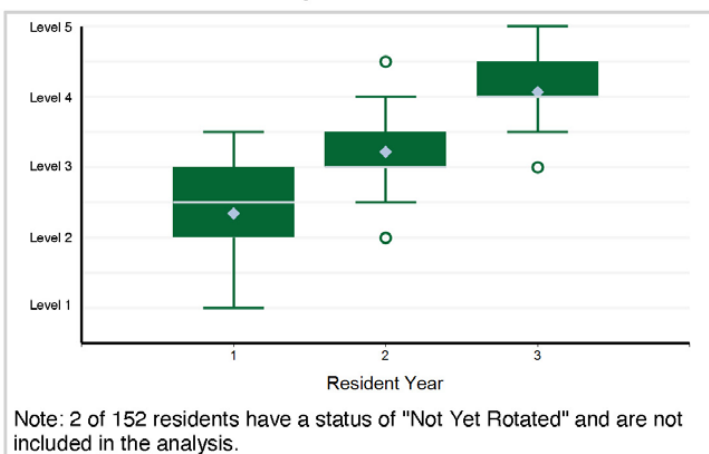

Note: 2 of 152 residents have a status of "Not Yet Rotated" and are not included in the analysis.

11. Medical Knowledge - Pelvic Organ Prolapse Treatment — Medical Knowledge

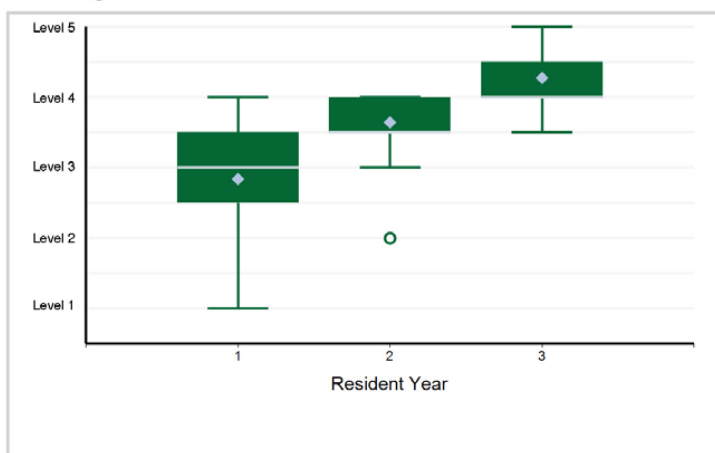

12. Medical Knowledge - Urogenital Fistulas and Urethral Diverticula Treatment — Medical Knowledge

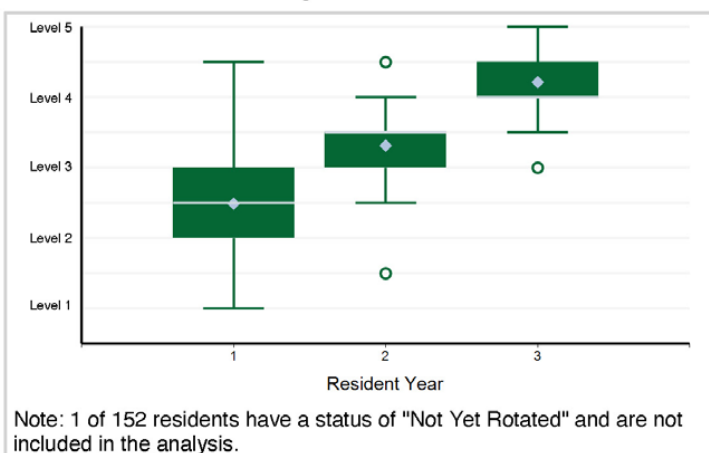

Note: 1 of 152 residents have a status of "Not Yet Rotated" and are not included in the analysis.

Specialty Box Plot Report - Milestone Evaluation by Resident Year: Year-End 2021-2022

SUBSPECIALTY: Female Pelvic Medicine and Reconstructive Surgery (multidisciplinary, Obstetrics and Gynecology)

13. Medical Knowledge - Painful Bladder Syndrome Treatment — Medical Knowledge

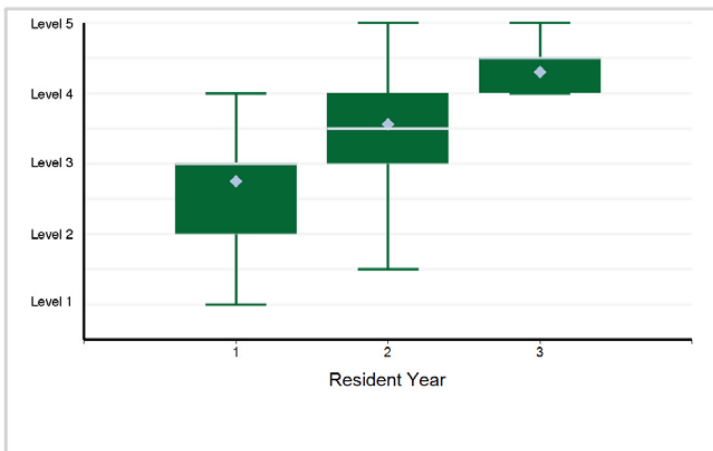

14. Medical Knowledge - Urinary Tract Infection — Medical Knowledge

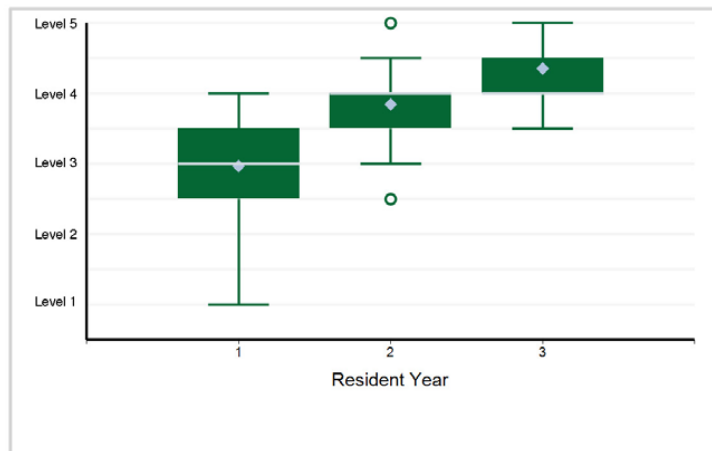

15. Medical Knowledge - Neuro-Urology — Medical Knowledge

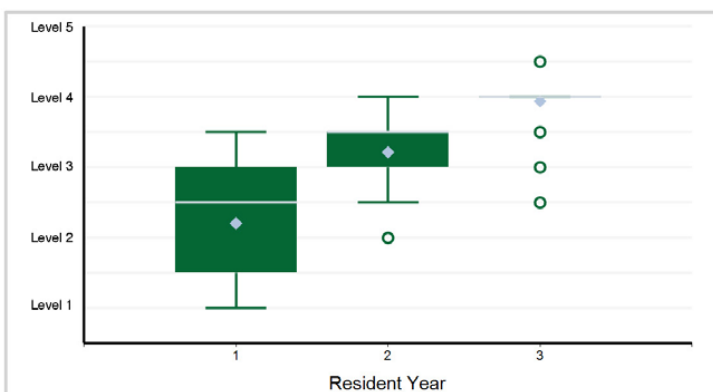

Note: 7 of 152 residents have a status of "Not Yet Rotated" and are not included in the analysis.

16. Systems-Based Practice - Computer Systems — Systems-Based Practice

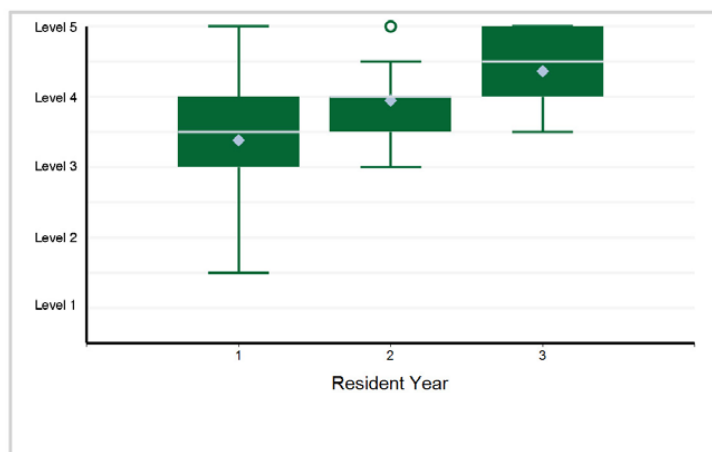

17. Systems-Based Practice - Health Care Economics — Systems-Based Practice

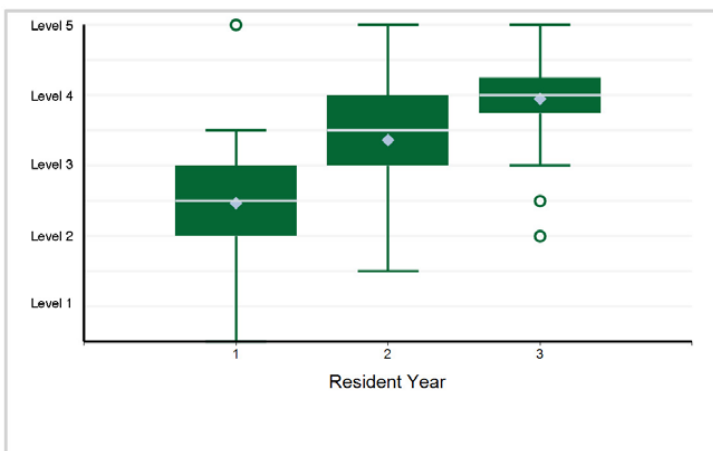

18. Systems-Based Practice - Works and coordinates patient care effectively in various health care delivery ...

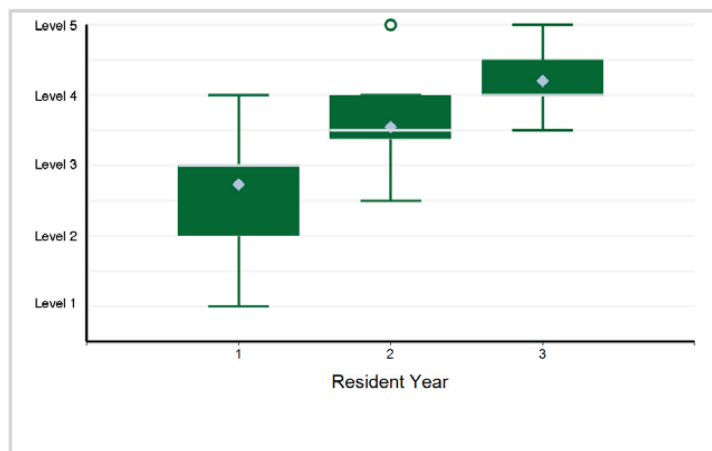

Specialty Box Plot Report - Milestone Evaluation by Resident Year: Year-End 2021-2022

SUBSPECIALTY: **Female Pelvic Medicine and Reconstructive Surgery (multidisciplinary, Obstetrics and Gynecology)**

19. Practice-Based Learning and Improvement - Scholarly Activity — Practice-Based Learning and Improvement

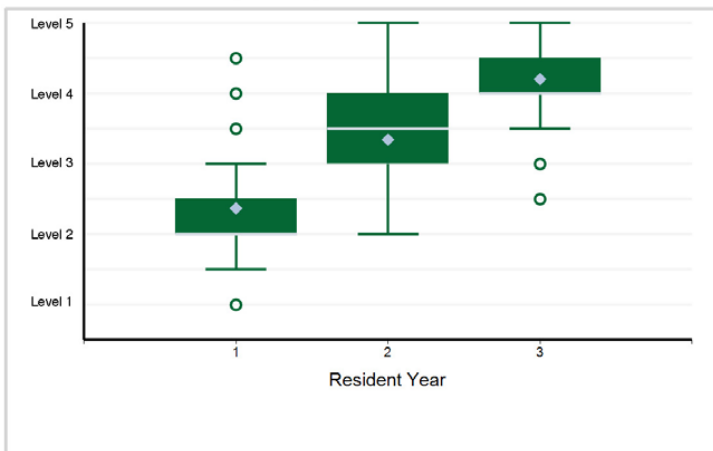

20. Practice-Based Learning and Improvement - Implements Quality Improvement Project — Practice-Based Learning and Improvement

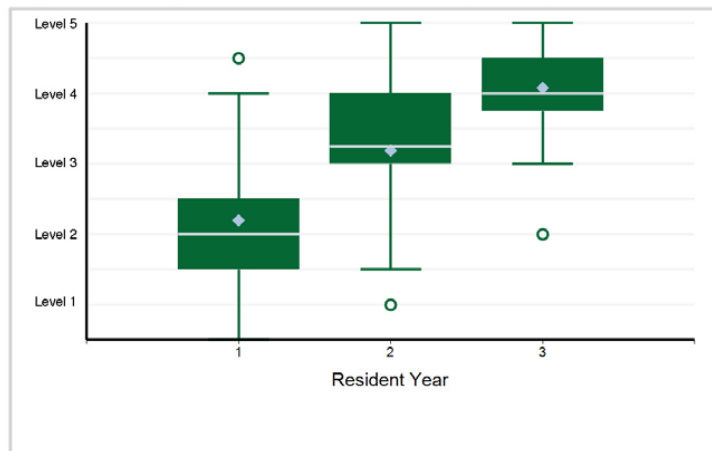

21. Professionalism - Professional Ethics and Accountability — Professionalism

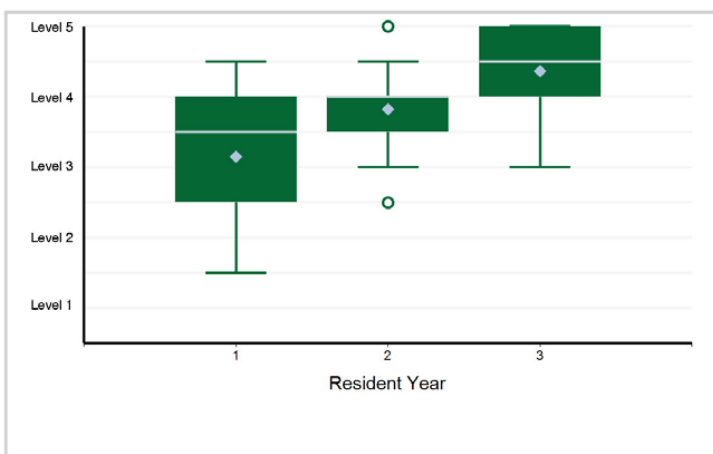

22. Interpersonal and Communication Skills - Health Care Teamwork — Interpersonal and Communication Skills

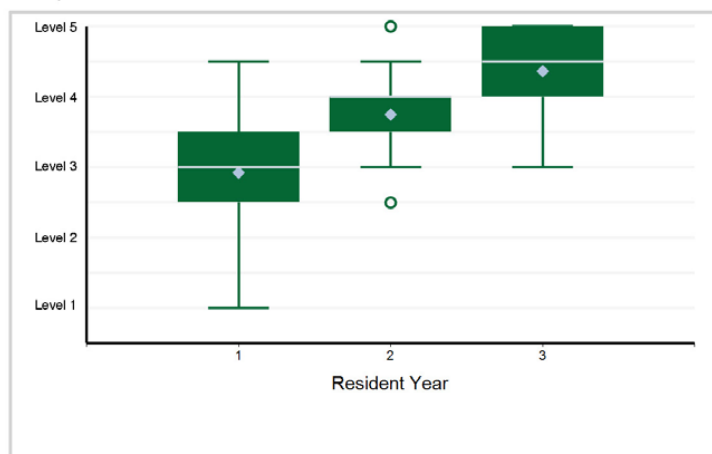

23. Interpersonal and Communication Skills - Effective Communication — Interpersonal and Communication Skills

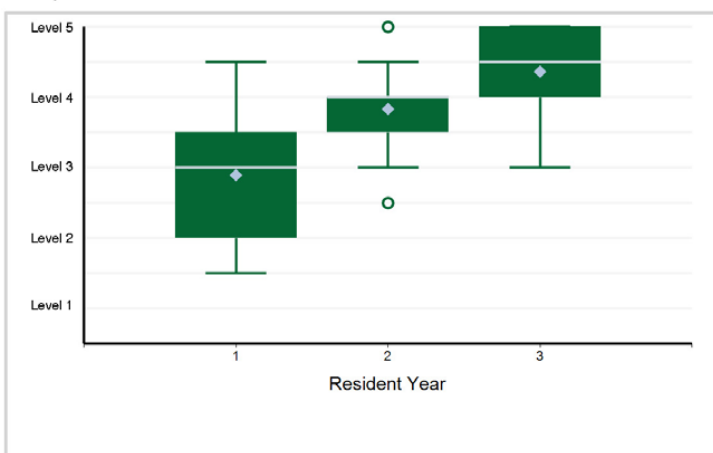

Specialty Box Plot Report - Milestone Evaluation by Resident Year: Year-End 2021-2022

TABLE 65: SUBSPECIALTY: **Gynecologic Oncology**

Resident Year	1	2	3	Total Residents
# of Residents	81	75	73	229

1. Patient Care - PC1: Surgical Care of Gynecologic Cancer – Open Techniques

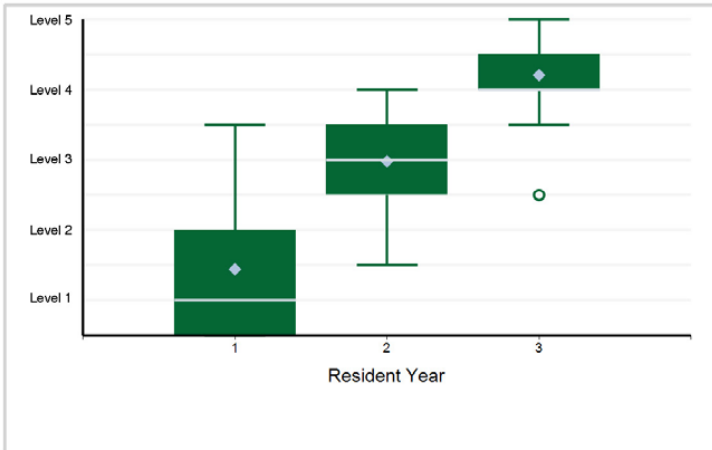

2. Patient Care - PC2: Surgical Care of Gynecologic Cancer – Minimally Invasive Surgical (MIS) Techniques

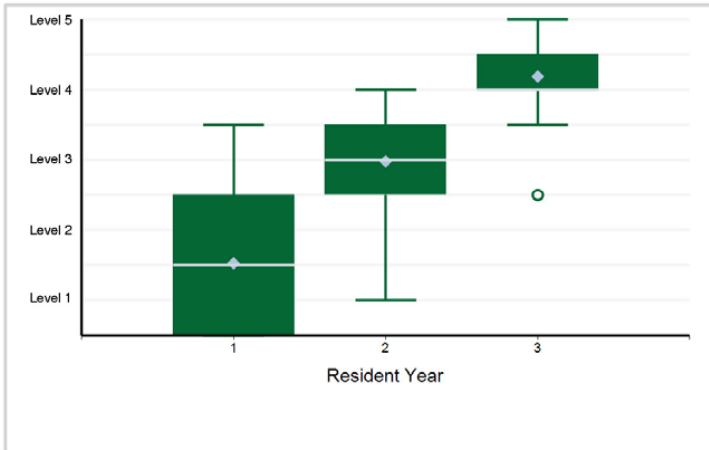

3. Patient Care - PC3: Medical Management of Gynecologic Cancer – Chemotherapy and Targeted Therapeutics

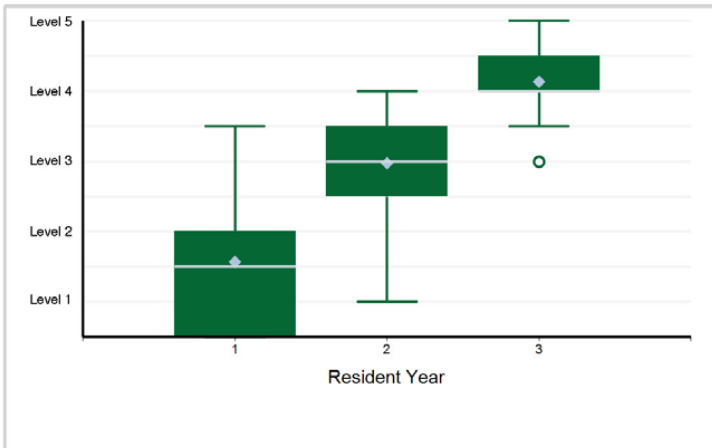

4. Patient Care - PC4: Peri-operative Care

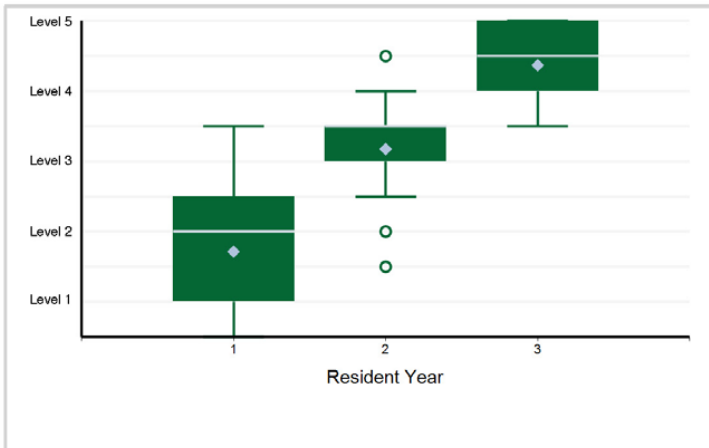

5. Patient Care - PC5: Hospice and Palliative Care

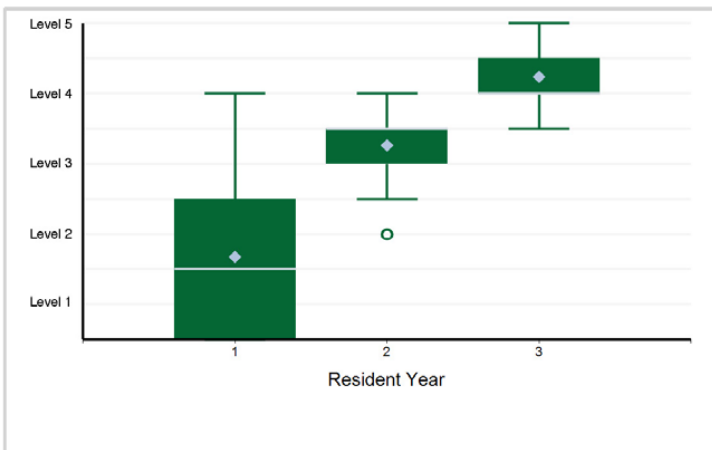

6. Medical Knowledge - MK1: Anatomy

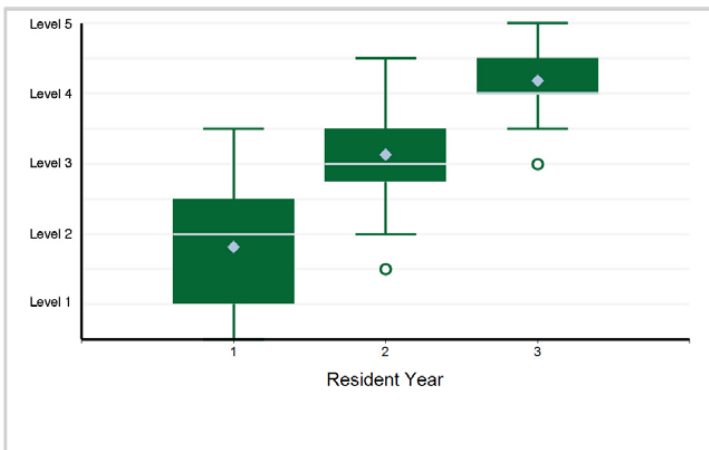

Specialty Box Plot Report - Milestone Evaluation by Resident Year: Year-End 2021-2022

SUBSPECIALTY: Gynecologic Oncology

7. Medical Knowledge - MK2: Pathology

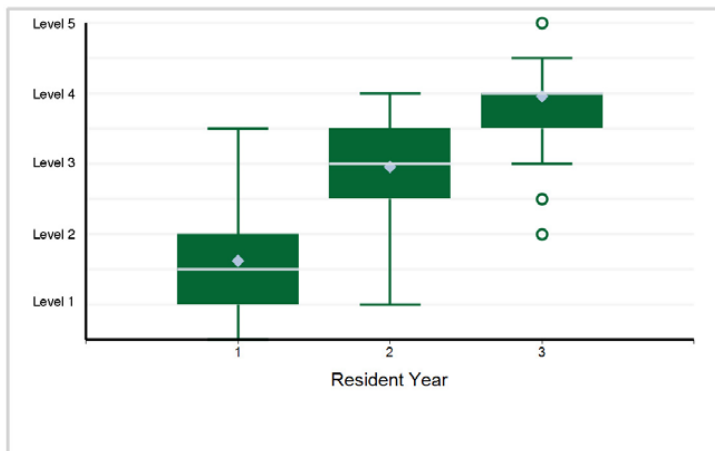

8. Medical Knowledge - MK3: Management of Medical Diseases in Gynecologic Cancer – Organ System Disorders

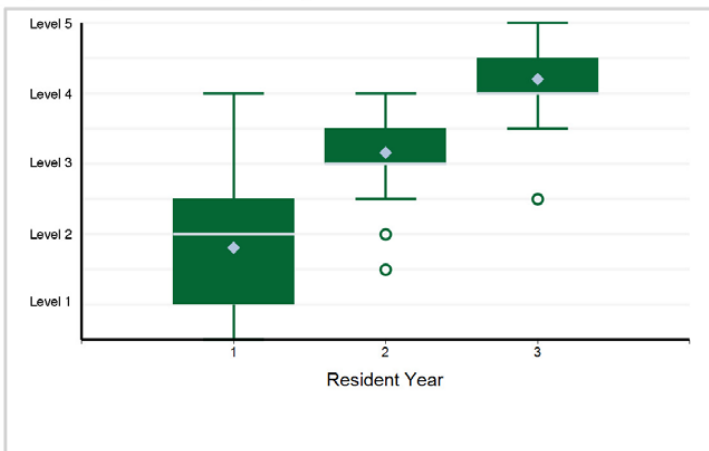

9. Medical Knowledge - MK4: Genetics, Cancer Biology, and Immunology

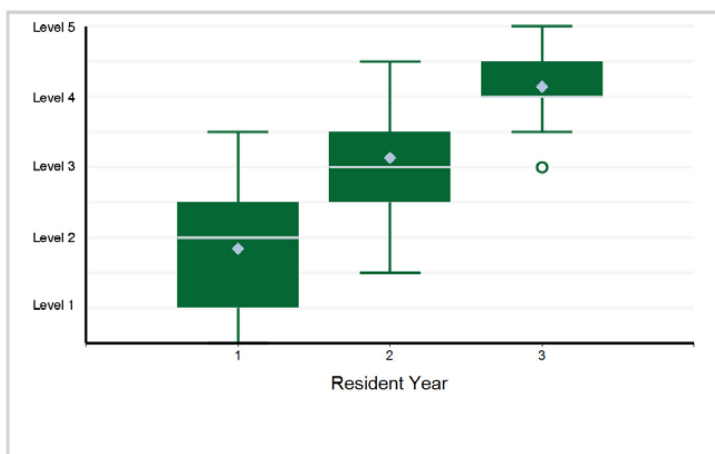

10. Medical Knowledge - MK5: Radiation Therapy – Radiation Biology and Physics

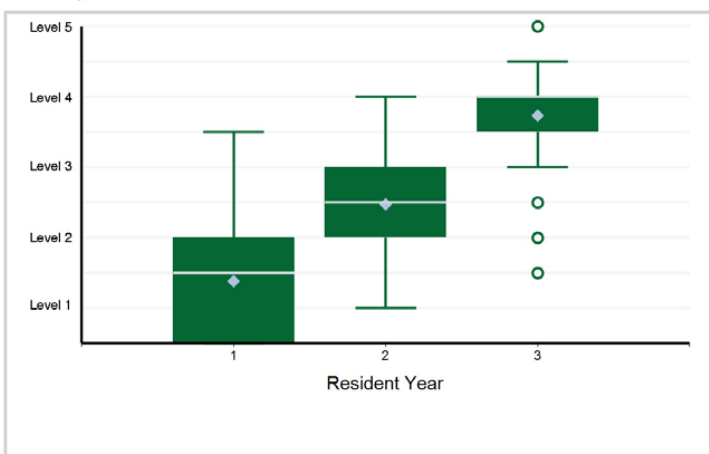

11. Medical Knowledge - MK6: Chemotherapy and Targeted Therapeutics

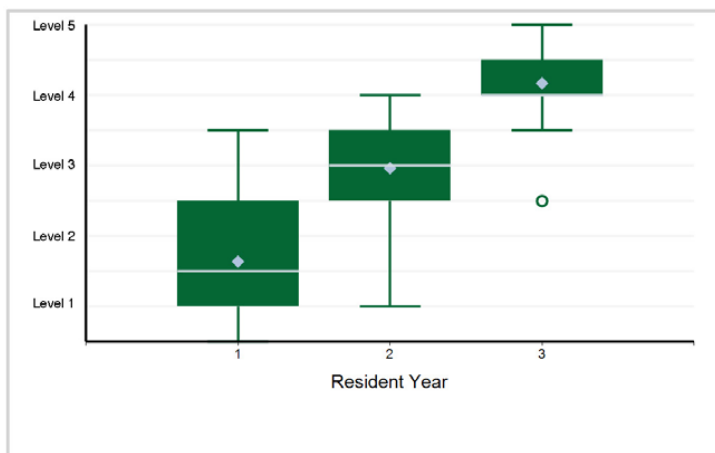

12. Medical Knowledge - MK7: Diagnostic Techniques and Treatment Planning

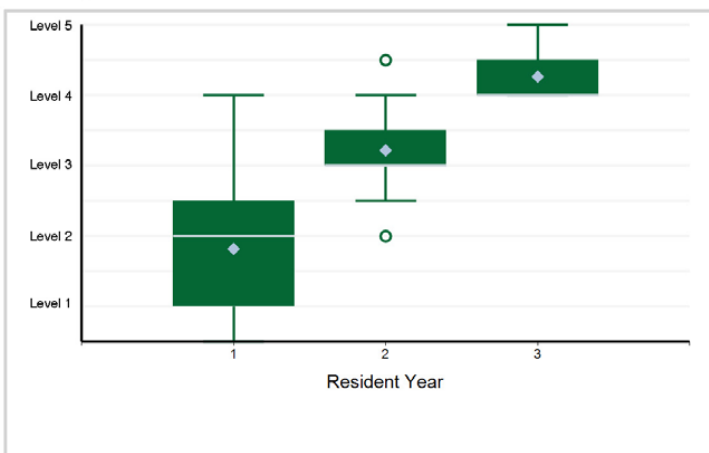

Specialty Box Plot Report - Milestone Evaluation by Resident Year: Year-End 2021-2022

SUBSPECIALTY: Gynecologic Oncology

13. Systems-Based Practice - SBP1: Computer Systems

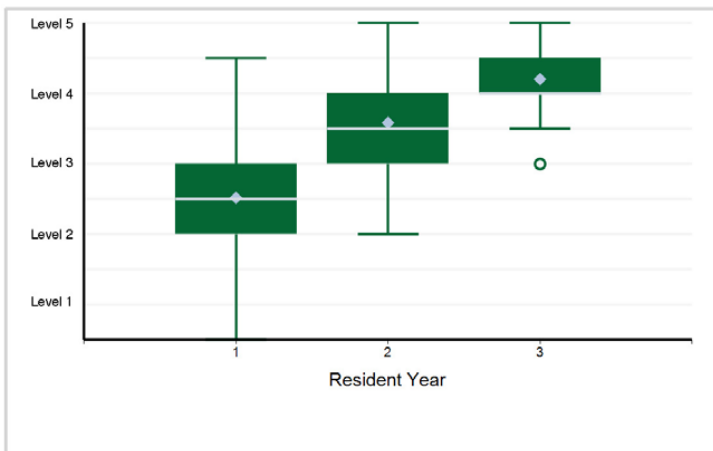

14. Systems-Based Practice - SBP2: Value-based Patient Care (Quality/Cost)

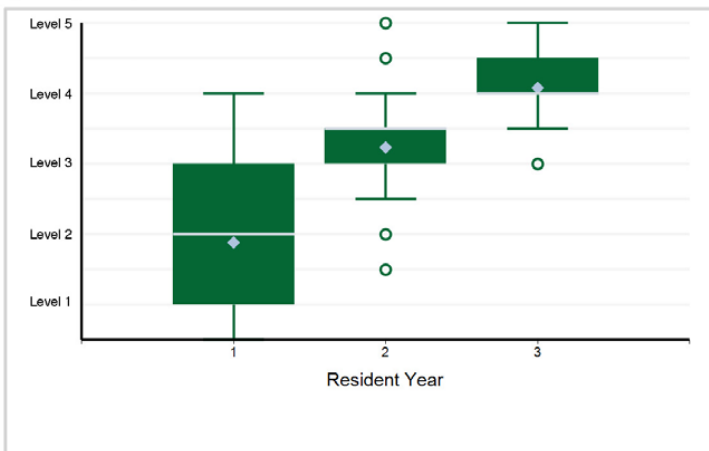

15. Practice-Based Learning and Improvement - PBL1: Scholarly Activity

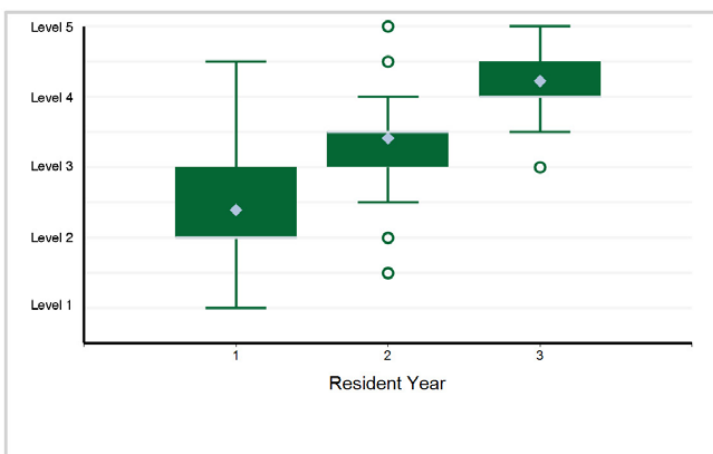

16. Practice-Based Learning and Improvement - PBL2: Quality Improvement (QI)

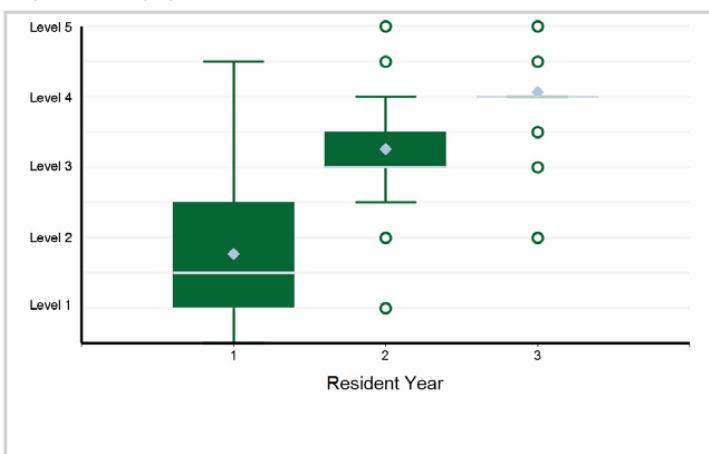

17. Professionalism - PROF1: Professional Ethics and Accountability

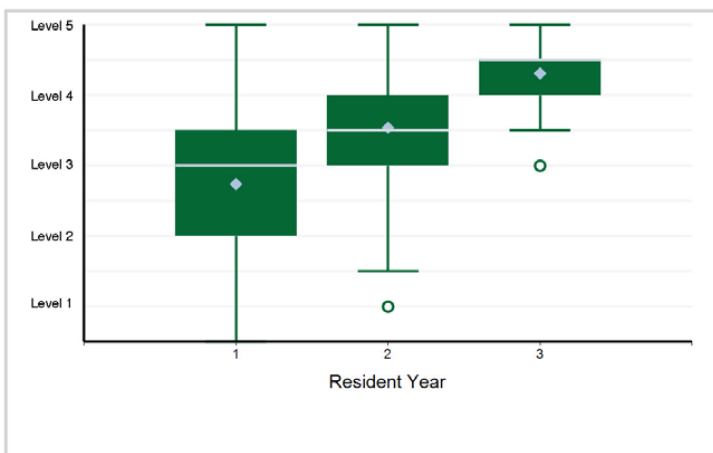

18. Professionalism - PROF2: Compassion, Integrity, and Respect for Others

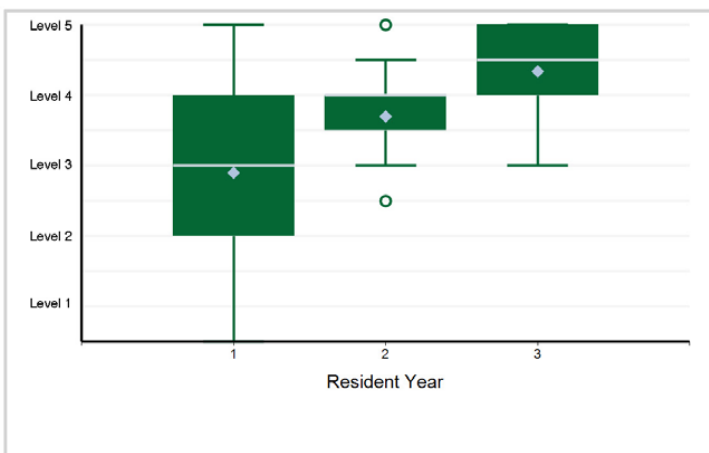

Specialty Box Plot Report - Milestone Evaluation by Resident Year: Year-End 2021-2022

SUBSPECIALTY: Gynecologic Oncology

19. Interpersonal and Communication Skills - ICS1: Teamwork and Communication with Physicians and Other Health Professionals

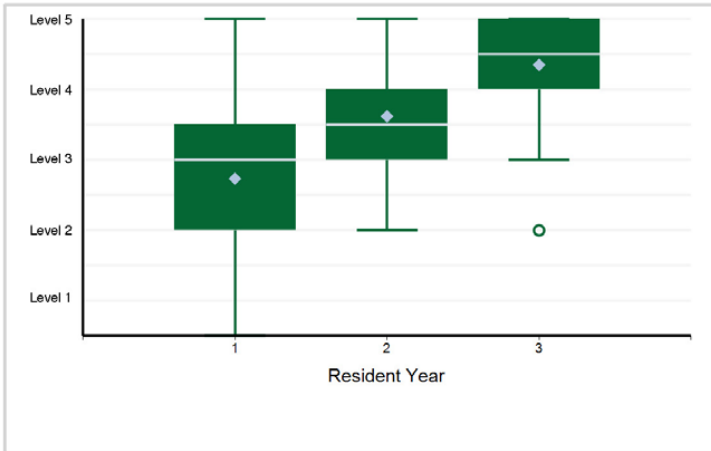

20. Interpersonal and Communication Skills - ICS2: Communication with Patients and Families

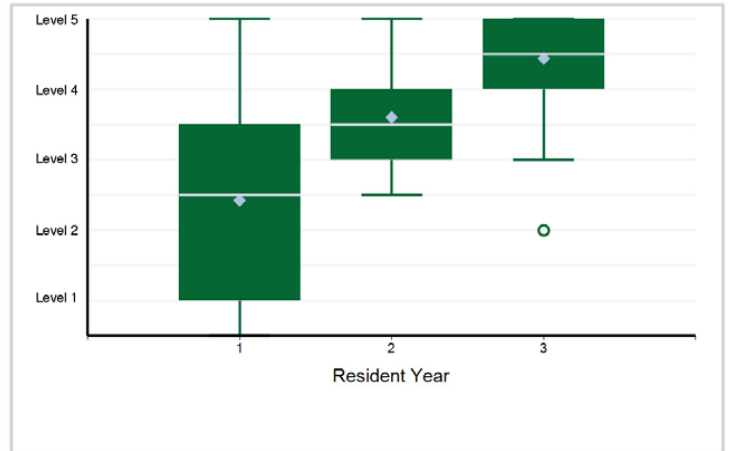

Specialty Box Plot Report - Milestone Evaluation by Resident Year: Year-End 2021-2022

TABLE 66: SUBSPECIALTY: **Maternal-Fetal Medicine**

Resident Year	1	2	3	Total Residents
# of Residents	142	130	131	403

1. Patient Care - PC1: Labor and Delivery Procedures

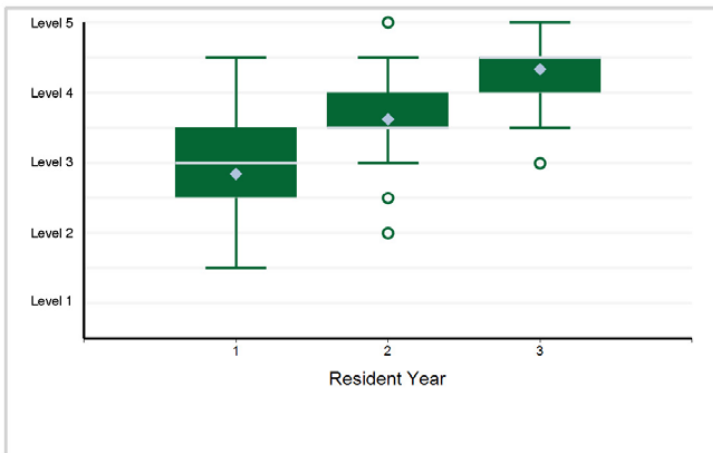

2. Patient Care - PC2: Sonographic Diagnosis and Procedures

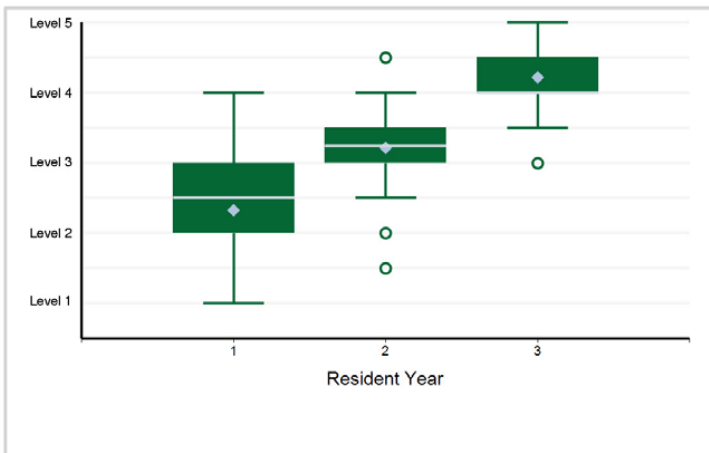

3. Patient Care - PC3: Medical Complications of Pregnancy

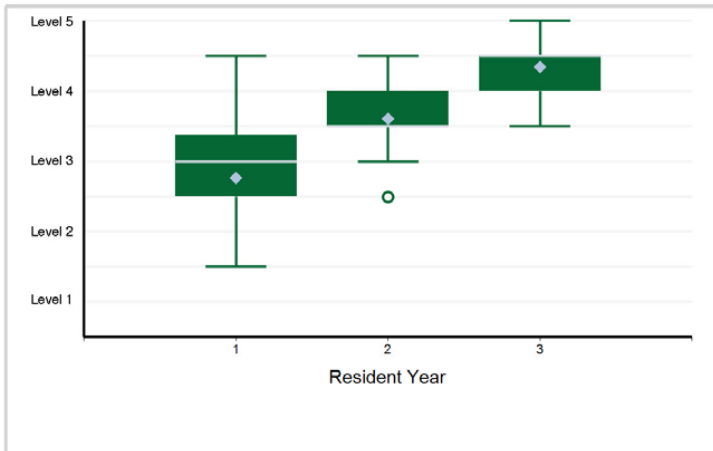

4. Patient Care - PC4: Obstetrical Complications

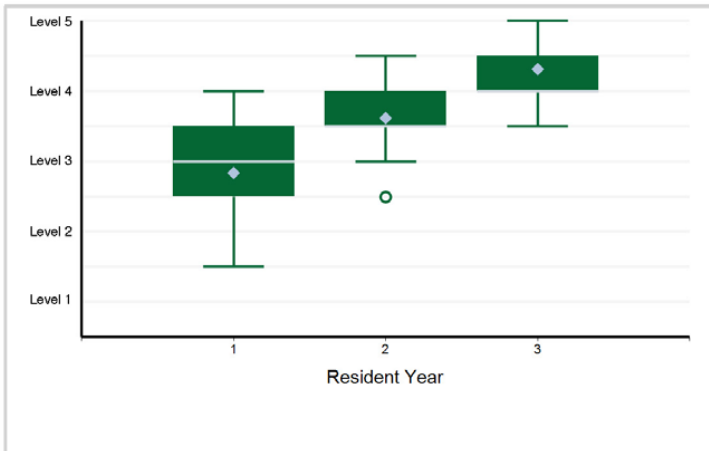

5. Medical Knowledge - MK1: Pathology, Anatomy, and Physiology

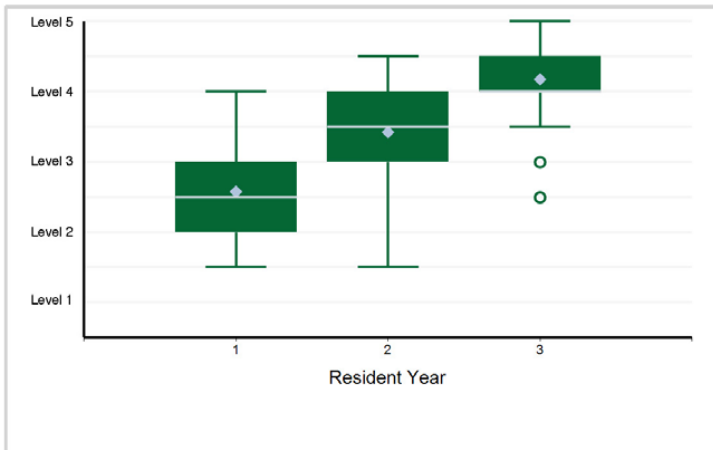

6. Medical Knowledge - MK2: Medical Complications of Pregnancy

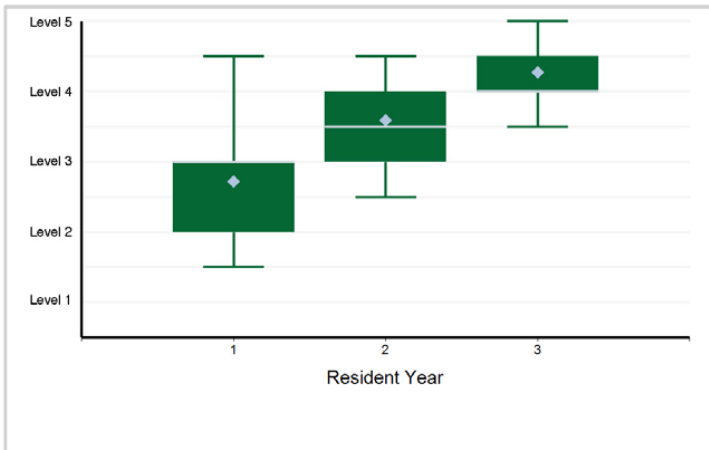

Specialty Box Plot Report - Milestone Evaluation by Resident Year: Year-End 2021-2022

SUBSPECIALTY: Maternal-Fetal Medicine

7. Medical Knowledge - MK3: Obstetrical Complications

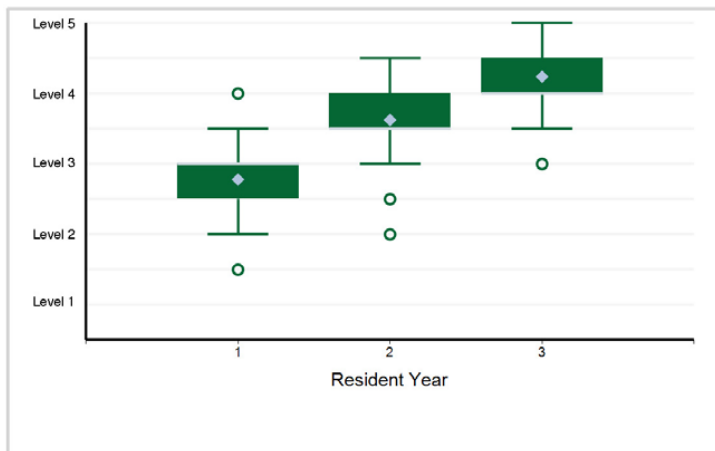

8. Medical Knowledge - MK4: Genetic Principles

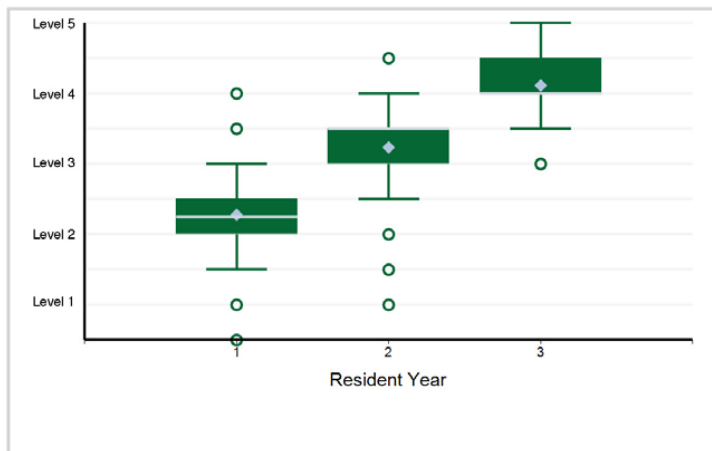

9. Medical Knowledge - MK5: Prenatal Imaging and Diagnosis

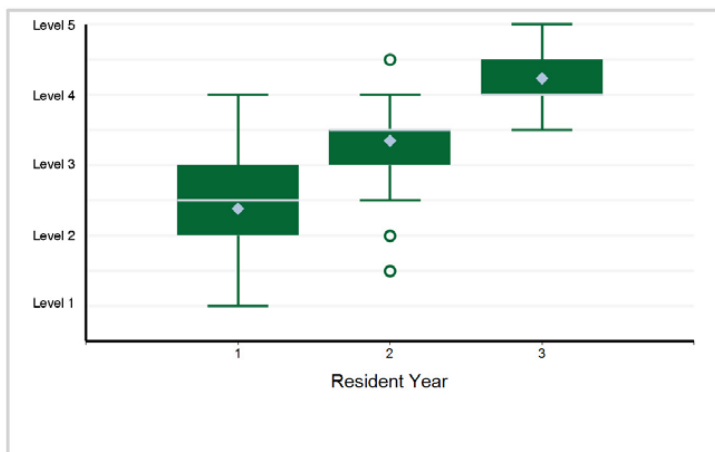

10. Systems-Based Practice - SBP1: Computer Systems

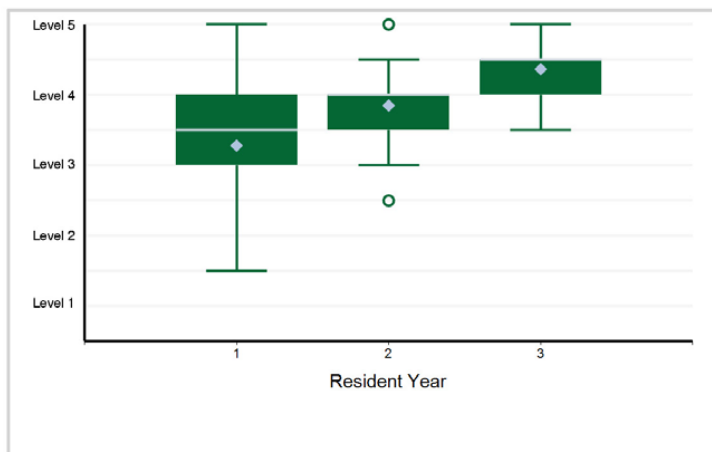

11. Systems-Based Practice - SBP2: Value-based Patient Care (Quality/Cost)

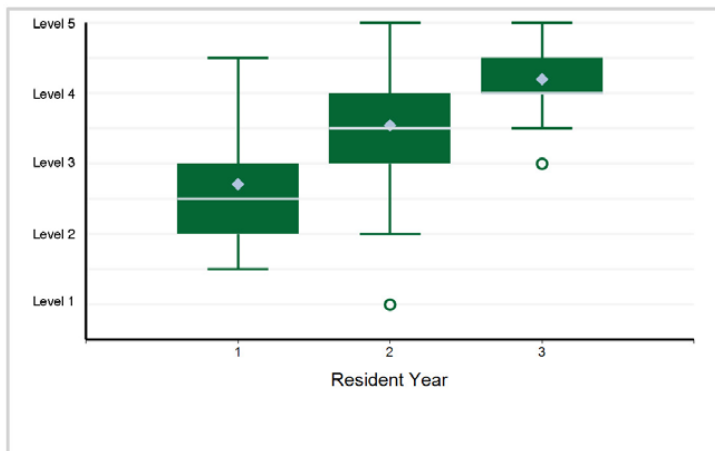

12. Practice-Based Learning and Improvement - PBLI1: Scholarly Activity

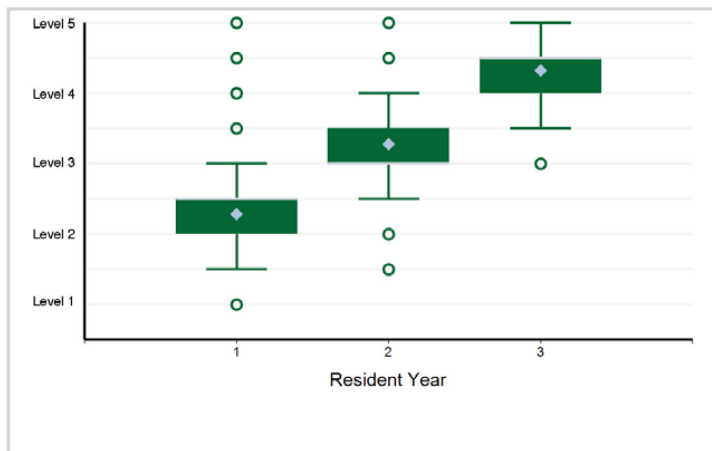

Specialty Box Plot Report - Milestone Evaluation by Resident Year: Year-End 2021-2022

SUBSPECIALTY: Maternal-Fetal Medicine

13. Practice-Based Learning and Improvement - PBLI2: Quality Improvement (QI)

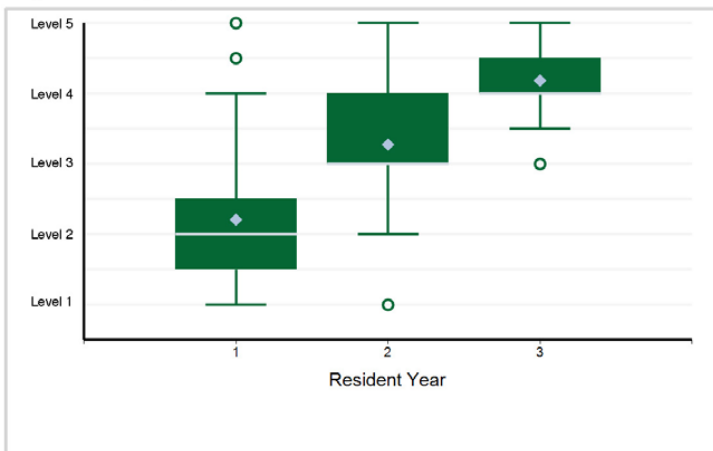

14. Practice-Based Learning and Improvement - PBLI3: Education of Team Members

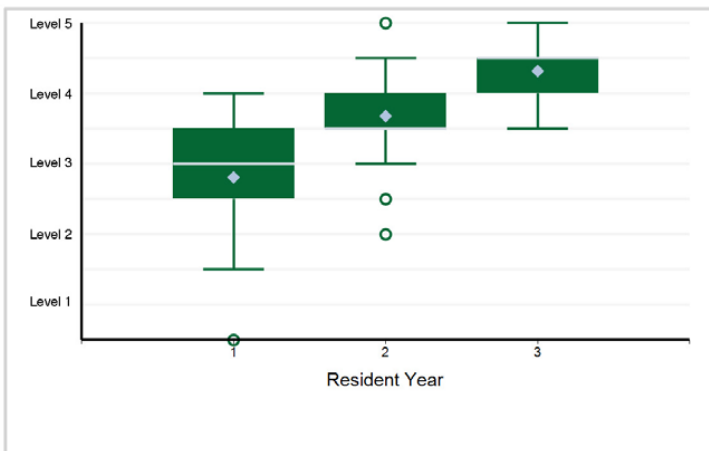

15. Professionalism - PROF1: Professional Ethics and Accountability

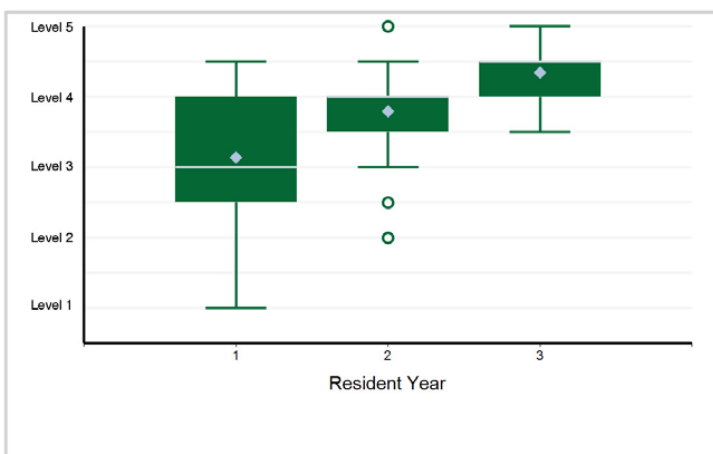

16. Professionalism - PROF2: Compassion, Integrity, and Respect for Others

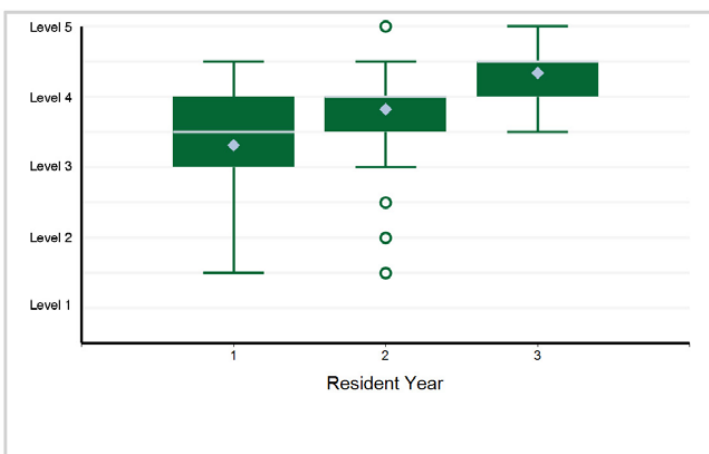

17. Interpersonal and Communication Skills - ICS1: Teamwork and Communication with Physicians and Other Health Professionals

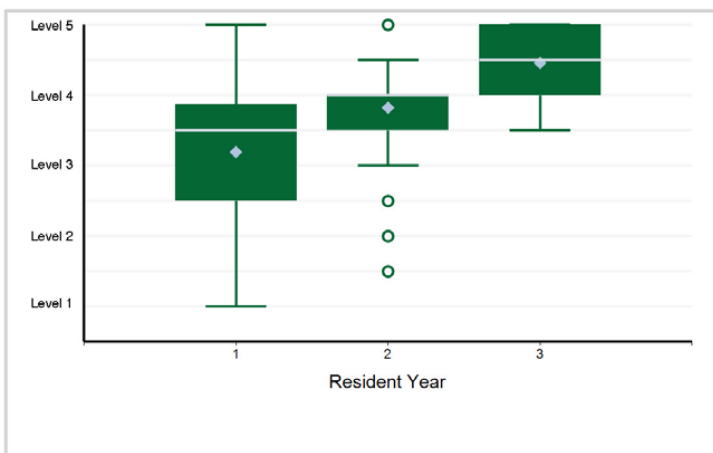

18. Interpersonal and Communication Skills - ICS2: Communication with Patients and Families

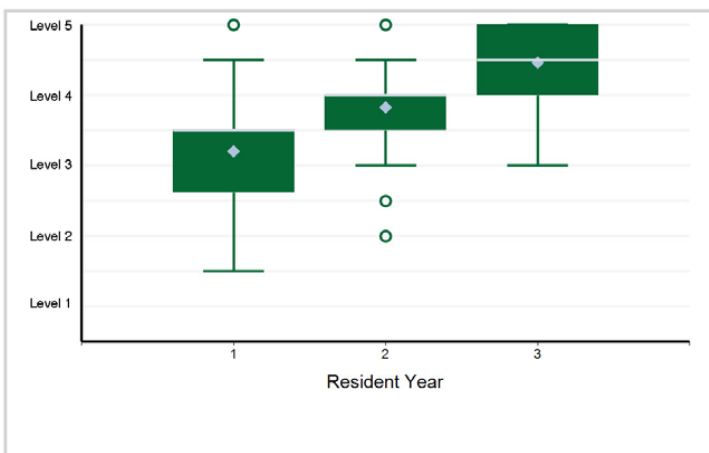

Specialty Box Plot Report - Milestone Evaluation by Resident Year: Year-End 2021-2022

TABLE 67: SUBSPECIALTY: **Reproductive Endocrinology and Infertility**

Resident Year	1	2	3	Total Residents*
# of Residents	61	55	56	172

*Note: There are 1 residents with an incomplete milestone evaluation that are excluded from the box plots below.

1. Patient Care - PC1: General Infertility Evaluation

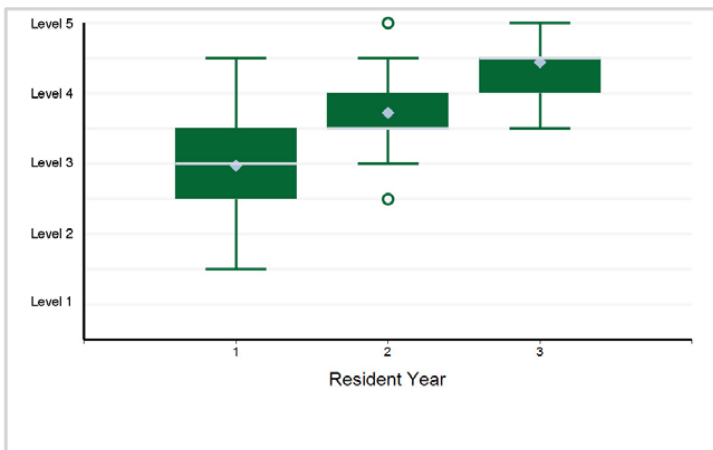

2. Patient Care - PC2: Ovulation Induction (OI) and Assisted Reproductive Technologies (ART)

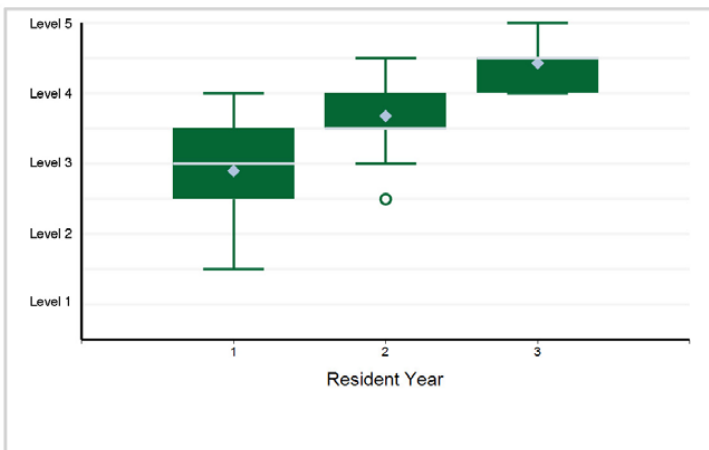

3. Patient Care - PC3: Surgery for Reproductive Disorders

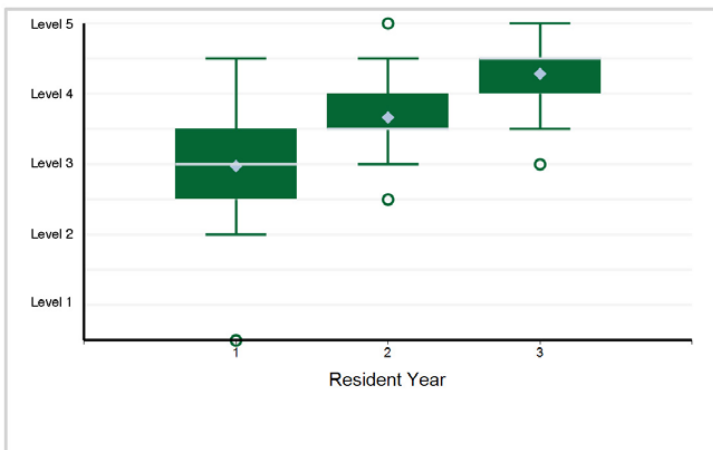

4. Medical Knowledge - MK1: Diagnostic Techniques and Treatment Planning for Reproductive Disorders

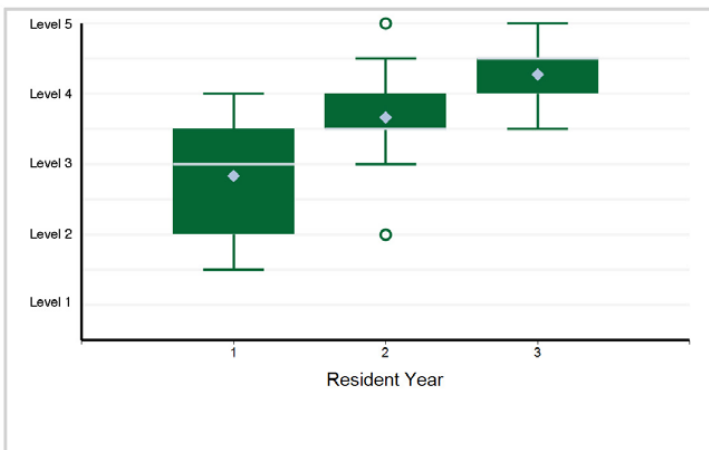

5. Medical Knowledge - MK2: Genetic Principles

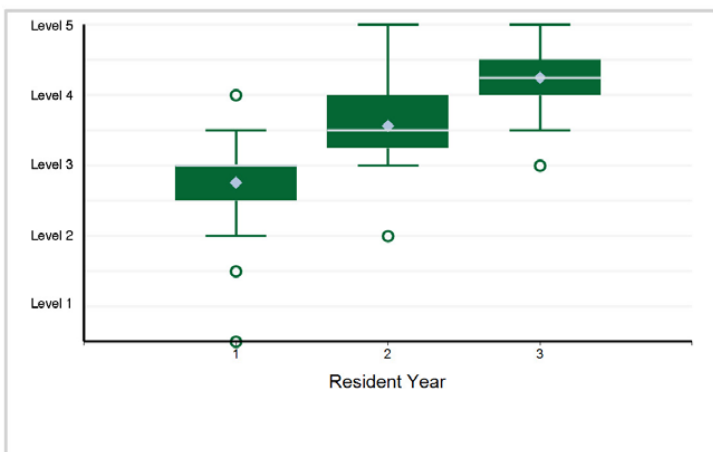

6. Medical Knowledge - MK3: Reproductive Medicine and Neuroendocrinology

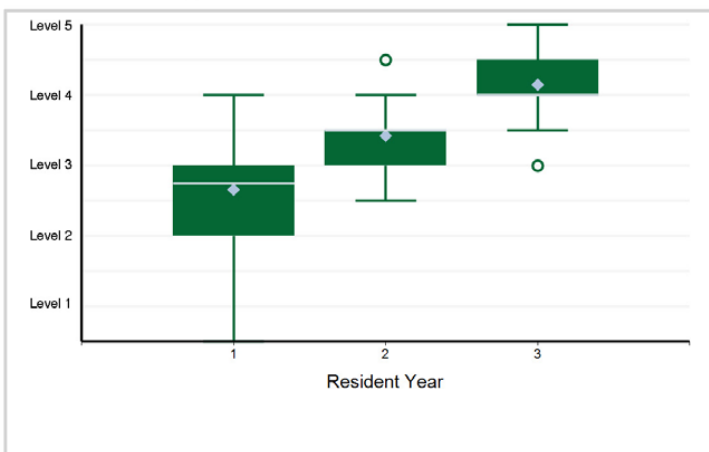

Specialty Box Plot Report - Milestone Evaluation by Resident Year: Year-End 2021-2022

SUBSPECIALTY: Reproductive Endocrinology and Infertility

7. Systems-Based Practice - SBP1: Computer Systems

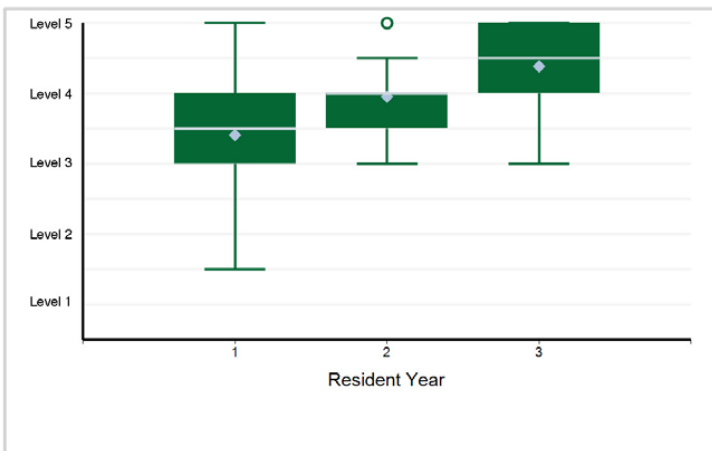

8. Systems-Based Practice - SBP2: Value-based Patient Care (Quality/Cost)

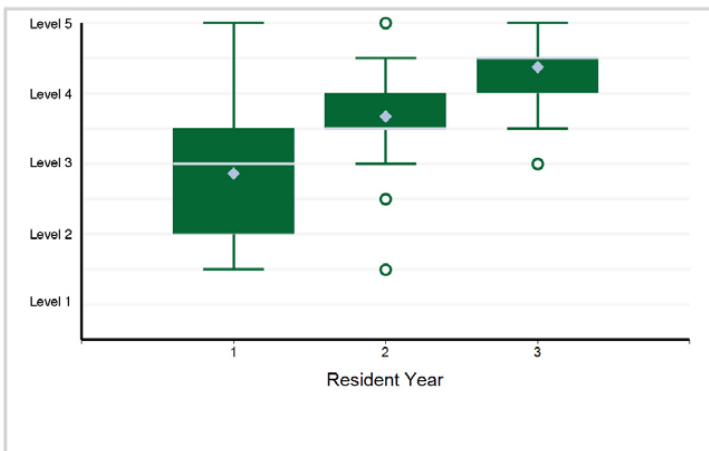

9. Practice-Based Learning and Improvement - PBLI1: Scholarly Activity

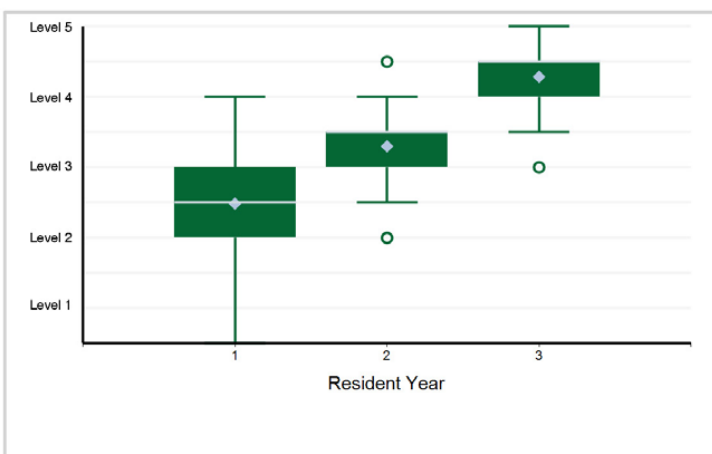

10. Practice-Based Learning and Improvement - PBLI2: Quality Improvement (QI)

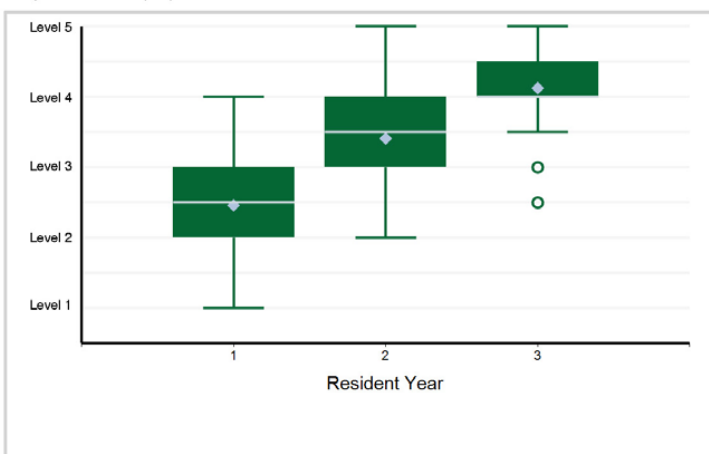

11. Practice-Based Learning and Improvement - PBLI3: Education of Team Members

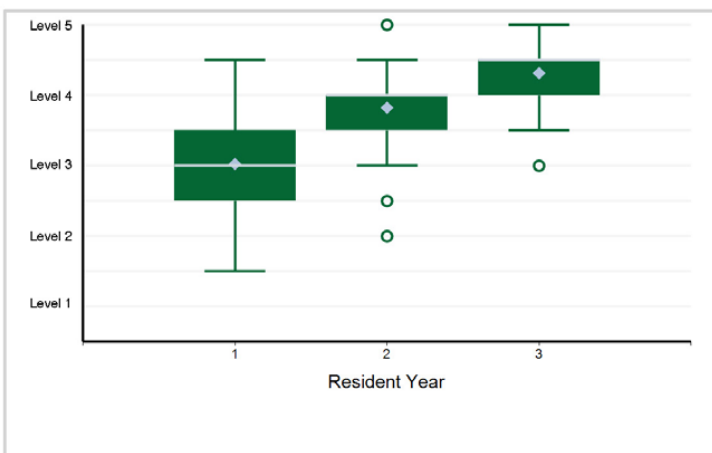

12. Professionalism - PROF1: Professional Ethics and Accountability

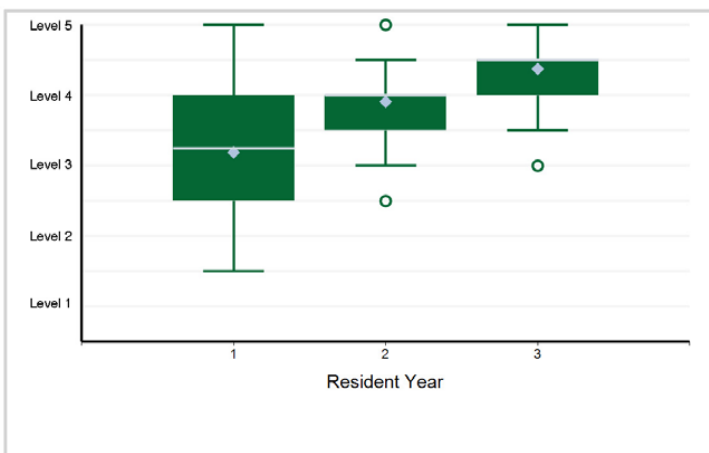

Specialty Box Plot Report - Milestone Evaluation by Resident Year: Year-End 2021-2022

SUBSPECIALTY: Reproductive Endocrinology and Infertility

13. Professionalism - PROF2: Compassion, Integrity, and Respect for Others

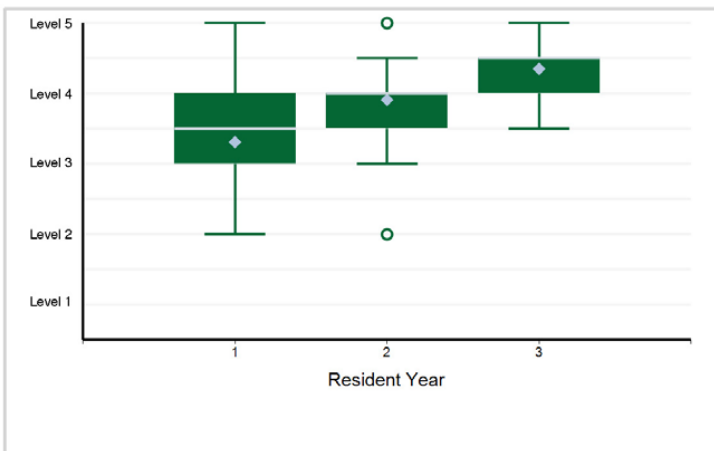

14. Interpersonal and Communication Skills - ICS1: Teamwork and Communication with Physicians and Other Health Professionals

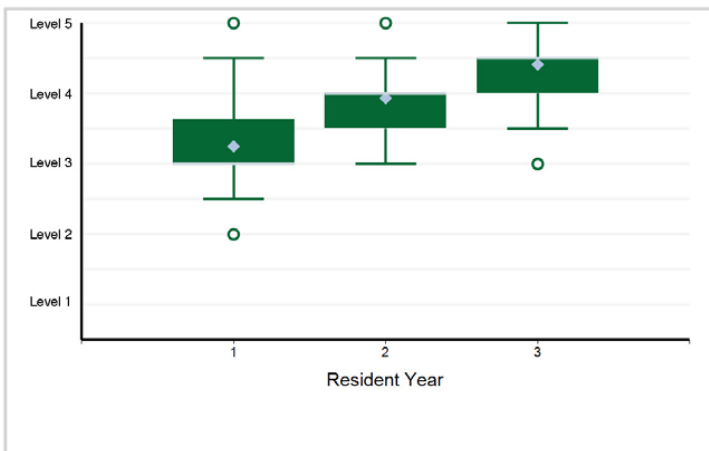

15. Interpersonal and Communication Skills - ICS2: Communication with Patients and Partner (if applicable)

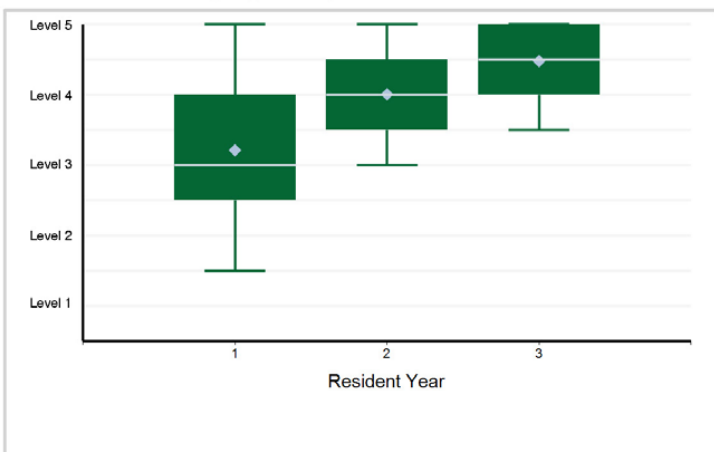

Specialty Box Plot Report - Milestone Evaluation by Resident Year: Year-End 2021-2022

TABLE 68: SPECIALTY: **Ophthalmology**

Resident Year	1	2	3	4	Total Residents
# of Residents	171	519	507	496	1,693

1. Patient Care - Patient Care 1: Data Acquisition – Basic Ophthalmology Exam and Testing

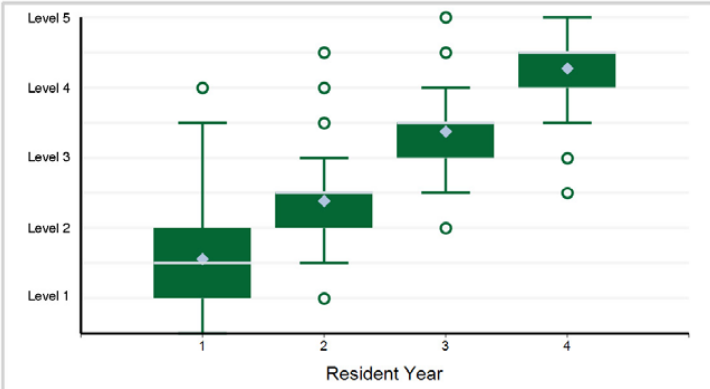

Note: 3 of 1,693 residents have a status of "Not Yet Assessable" and are not included in the analysis.

2. Patient Care - Patient Care 2: Hospital-Based Consultation

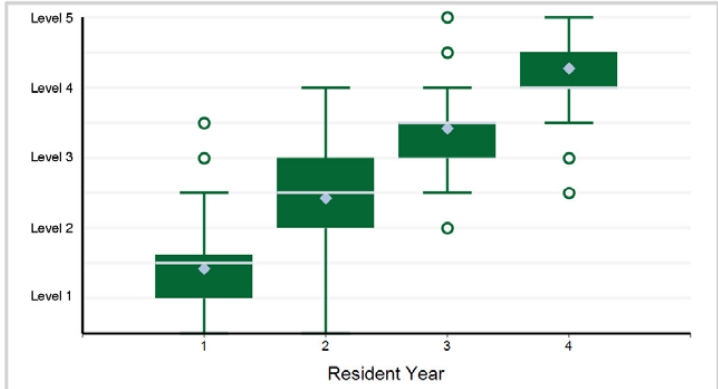

Note: 5 of 1,693 residents have a status of "Not Yet Assessable" and are not included in the analysis.

3. Patient Care - Patient Care 3: Office-Based Procedures

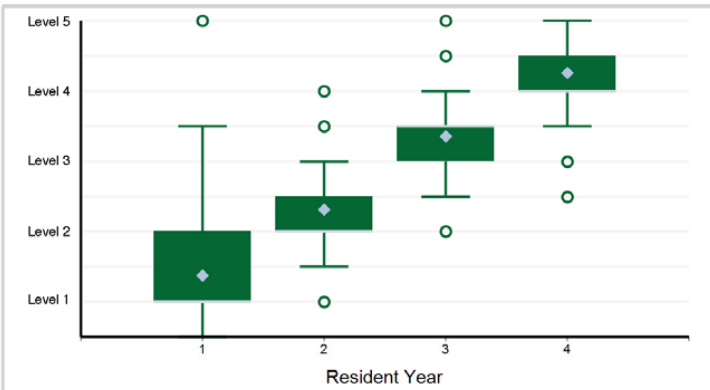

Note: 33 of 1,693 residents have a status of "Not Yet Assessable" and are not included in the analysis.

4. Patient Care - Patient Care 4: Cataract Surgery – Technical Skill

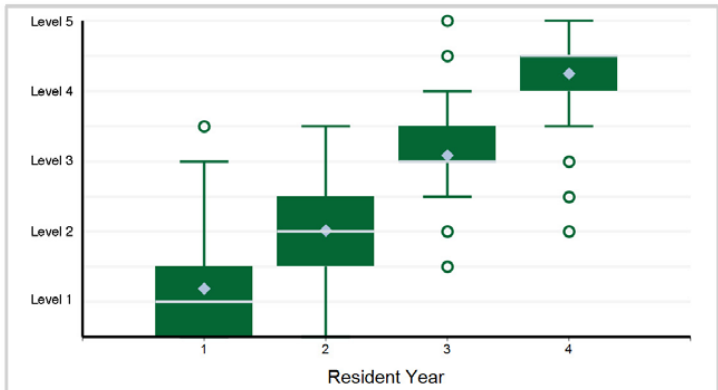

Note: 149 of 1,693 residents have a status of "Not Yet Assessable" and are not included in the analysis.

5. Patient Care - Patient Care 5: Extraocular Surgery (Plastics, Strabismus)

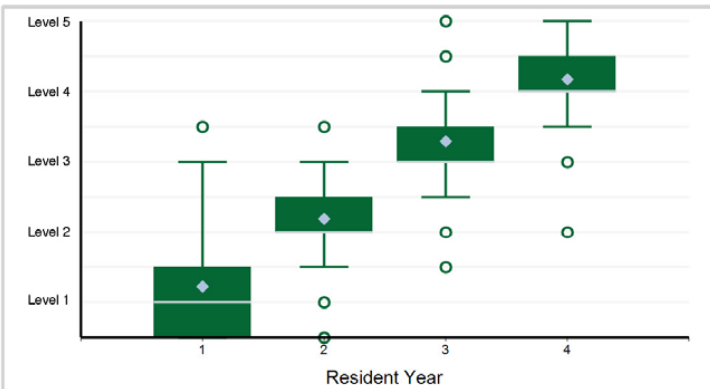

Note: 91 of 1,693 residents have a status of "Not Yet Assessable" and are not included in the analysis.

6. Patient Care - Patient Care 6: Intraocular Surgery (Cornea, Retina, Glaucoma)

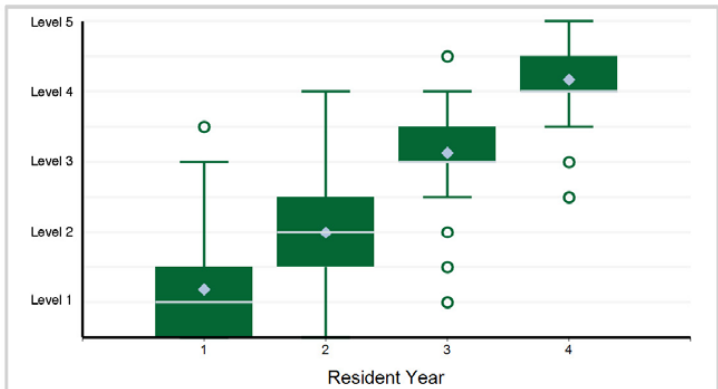

Note: 208 of 1,693 residents have a status of "Not Yet Assessable" and are not included in the analysis.

Specialty Box Plot Report - Milestone Evaluation by Resident Year: Year-End 2021-2022

SPECIALTY: **Ophthalmology**

7. Medical Knowledge - Medical Knowledge 1: Pathophysiology

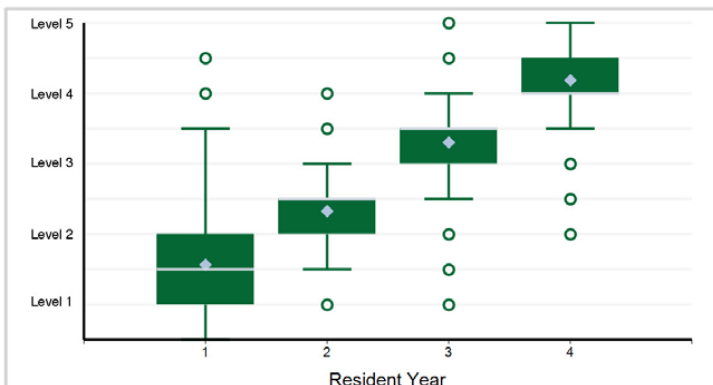

Note: 2 of 1,693 residents have a status of "Not Yet Assessable" and are not included in the analysis.

8. Medical Knowledge - Medical Knowledge 2: Differential Diagnosis

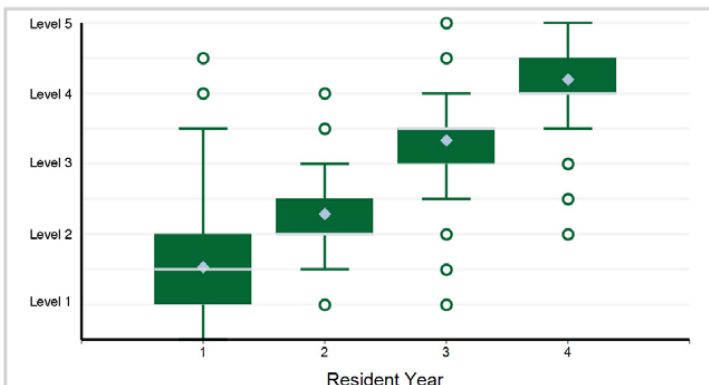

Note: 1 of 1,693 residents have a status of "Not Yet Assessable" and are not included in the analysis.

9. Medical Knowledge - Medical Knowledge 3: Therapeutic Interventions

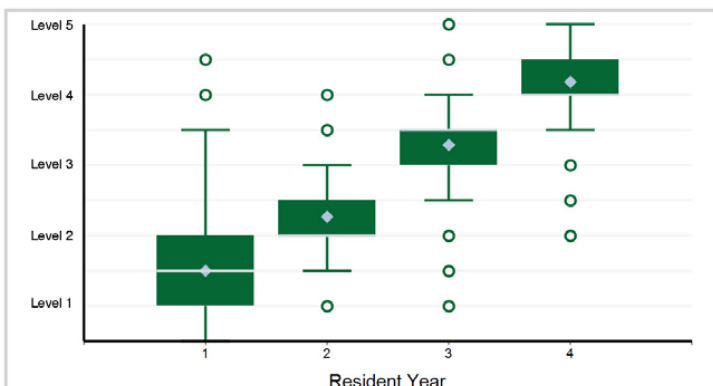

Note: 11 of 1,693 residents have a status of "Not Yet Assessable" and are not included in the analysis.

10. Systems-Based Practice - Systems-Based Practice 1: Patient Safety and Quality Improvement

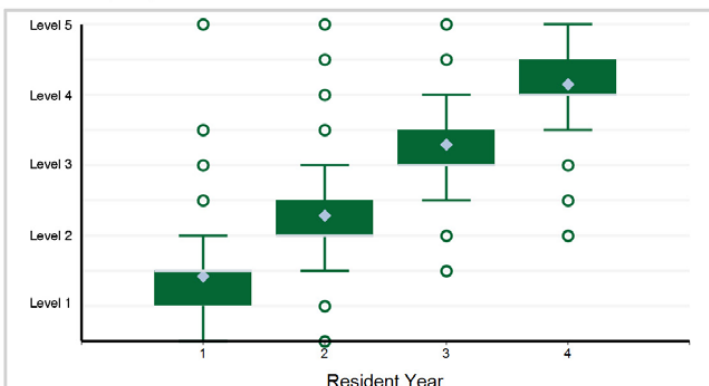

11. Systems-Based Practice - Systems-based Practice 2: System Navigation for Patient-Centered Care

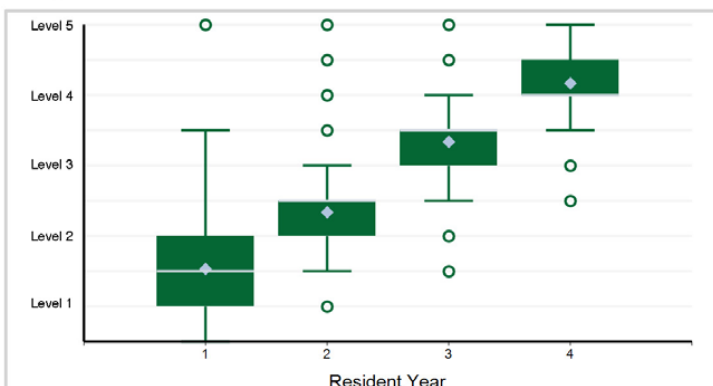

12. Systems-Based Practice - Systems-Based Practice 3: Physician Role in Health Care Systems

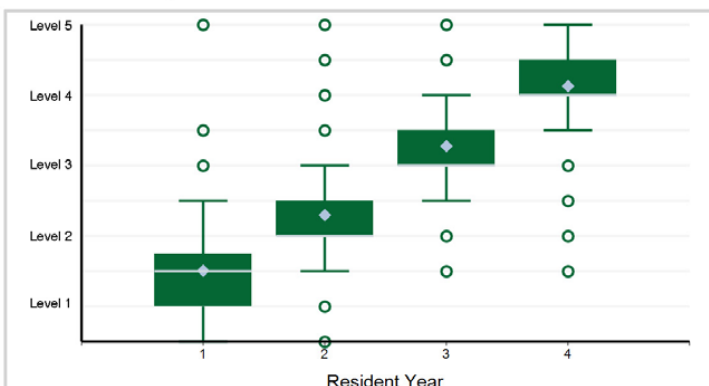

Specialty Box Plot Report - Milestone Evaluation by Resident Year: Year-End 2021-2022

SPECIALTY: Ophthalmology

13. Practice-Based Learning and Improvement - Practice-Based Learning and Improvement 1: Evidence-Based and Informed Practice

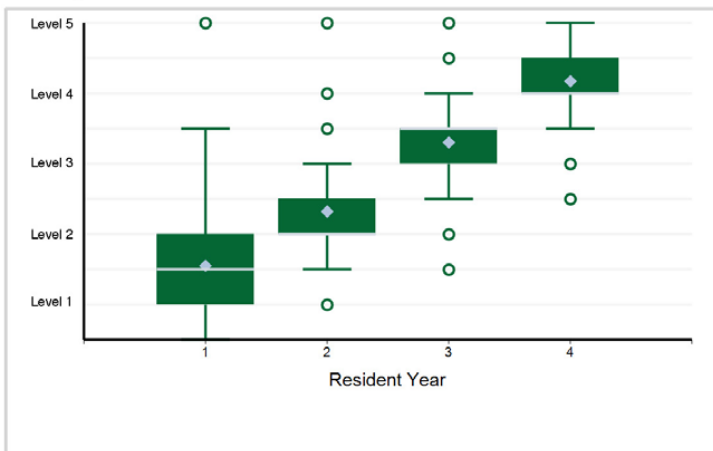

14. Practice-Based Learning and Improvement - Practice-Based Learning and Improvement 2: Reflective Practice and Commitment ...

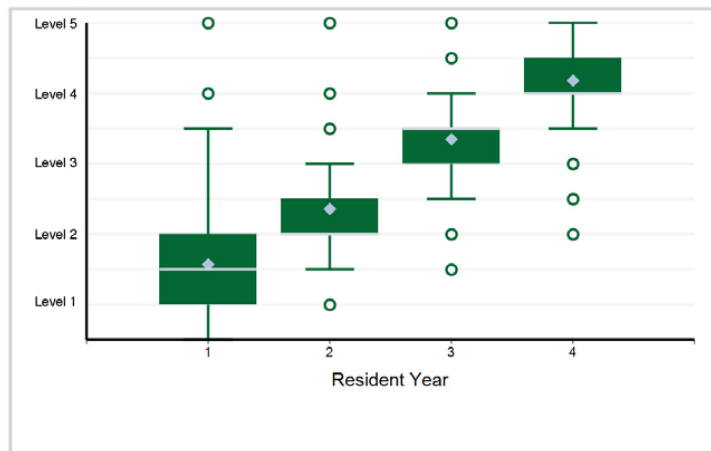

15. Professionalism - Professionalism 1: Professional Behavior and Ethical Principles

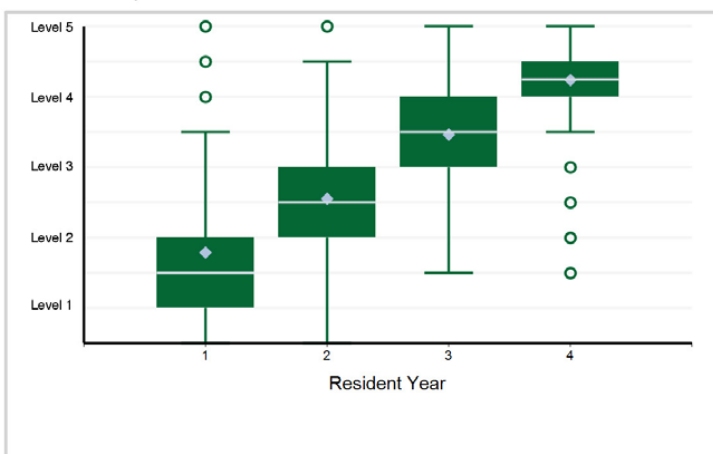

16. Professionalism - Professionalism 2: Accountability/Conscientiousness

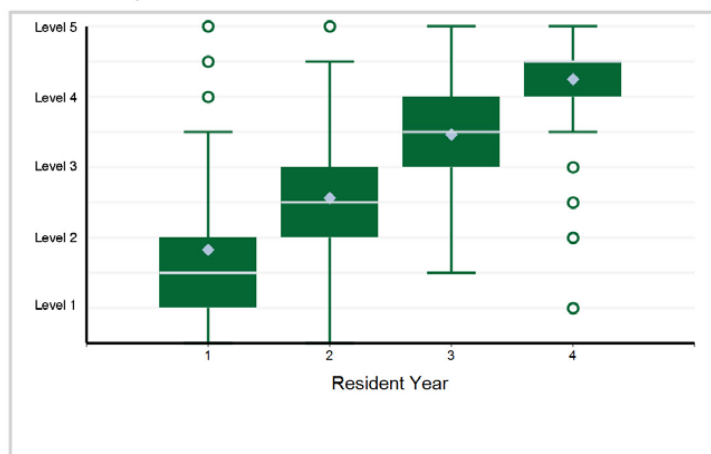

17. Professionalism - Professionalism 3: Self-Awareness and Help-Seeking

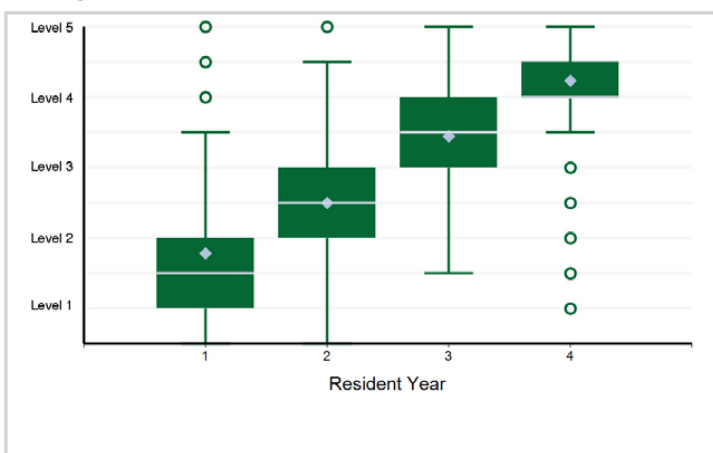

18. Interpersonal and Communication Skills - Interpersonal and Communication Skills 1: Patient and Family-Centered Communication

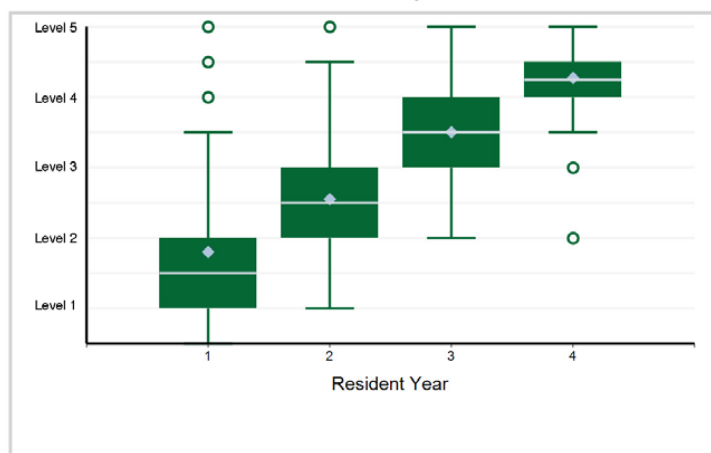

Specialty Box Plot Report - Milestone Evaluation by Resident Year: Year-End 2021-2022

SPECIALTY: **Ophthalmology**

19. Interpersonal and Communication Skills - Interpersonal and Communication Skills 2: Interprofessional and Team Communication

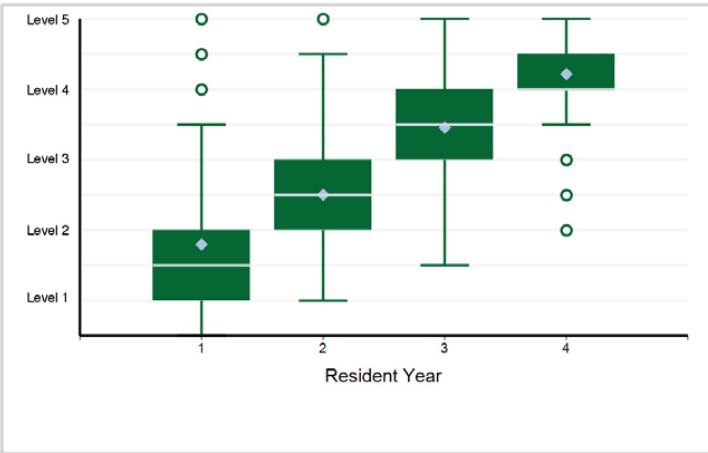

20. Interpersonal and Communication Skills - Interpersonal and Communication Skills 3: Communication within Health Care Systems

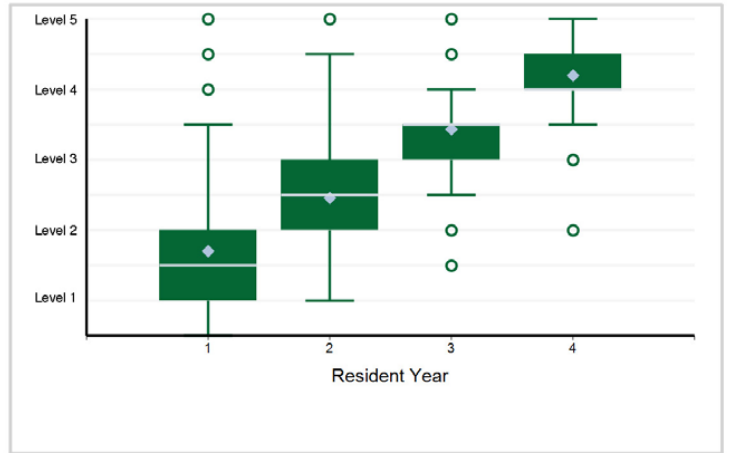

Specialty Box Plot Report - Milestone Evaluation by Resident Year: Year-End 2021-2022

TABLE 69: SPECIALTY: **Orthopaedic Surgery**

Resident Year	1	2	3	4	5	Total Residents*
# of Residents	909	905	889	891	876	4,470

*Note: There are 20 residents with an incomplete milestone evaluation that are excluded from the box plots below.

1. Patient Care - Patient Care 1: Operative Management of Fractures and Dislocations

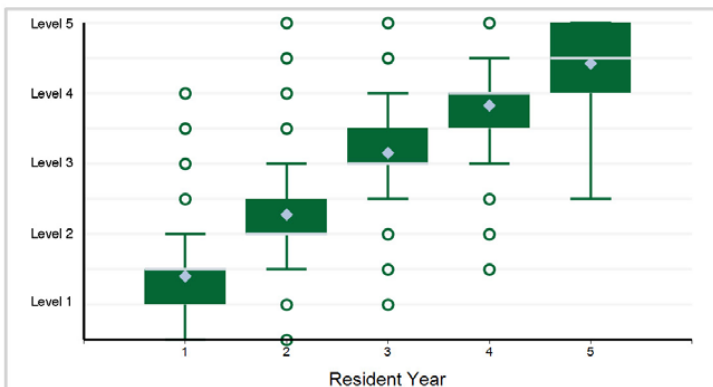

Note: 36 of 4,450 residents have a status of "Not Yet Assessable" and are not included in the analysis.

2. Patient Care - Patient Care 2: Operative Management of Soft Tissue Pathology

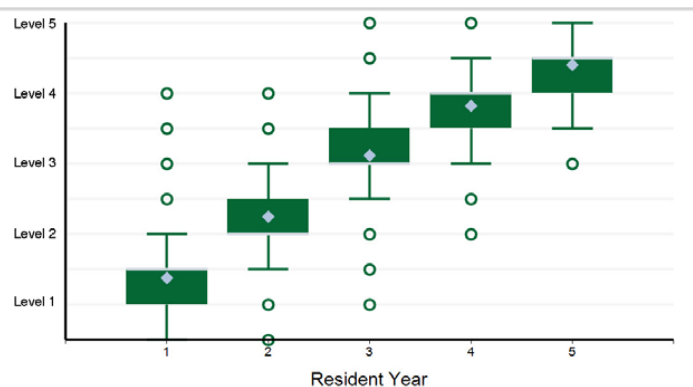

Note: 79 of 4,450 residents have a status of "Not Yet Assessable" and are not included in the analysis.

3. Patient Care - Patient Care 3: Operative Management of Degenerative, Infectious, and Neoplastic Conditions

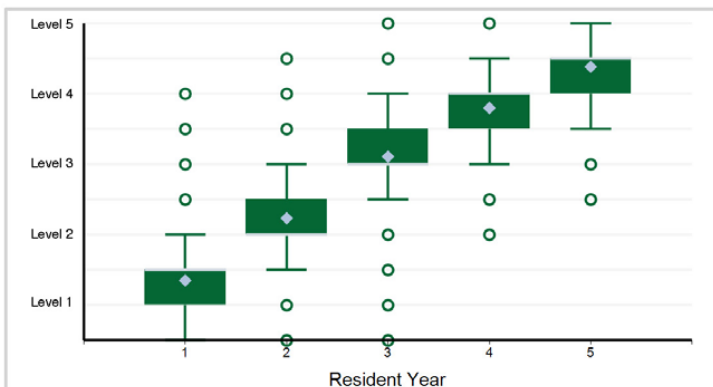

Note: 85 of 4,450 residents have a status of "Not Yet Assessable" and are not included in the analysis.

4. Patient Care - Patient Care 4: Operative Management of Arthroscopically Treated Conditions

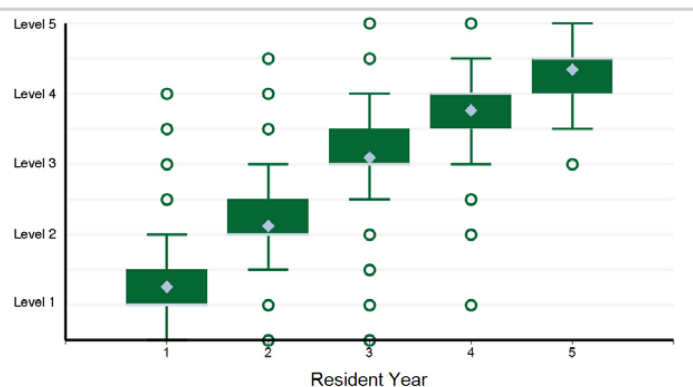

Note: 221 of 4,450 residents have a status of "Not Yet Assessable" and are not included in the analysis.

5. Patient Care - Patient Care 5: Operative Management of Pediatric Conditions

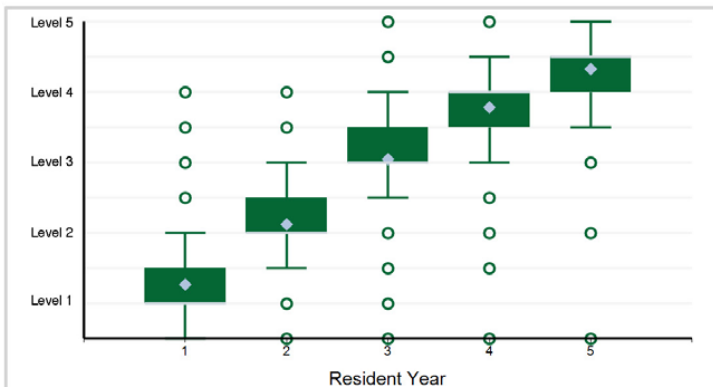

Note: 322 of 4,450 residents have a status of "Not Yet Assessable" and are not included in the analysis.

6. Patient Care - Patient Care 6: Evaluation and Management of the Adult Orthopaedic Patient

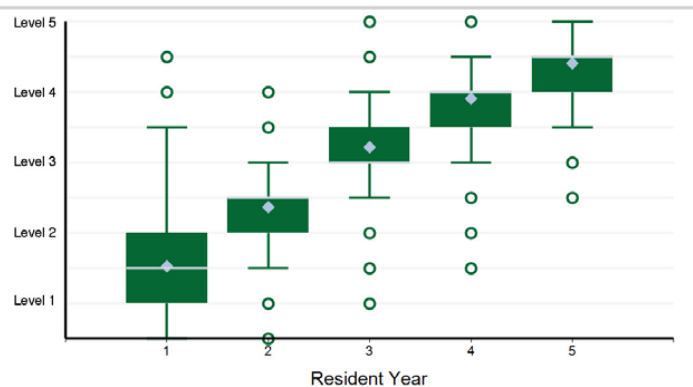

Note: 55 of 4,450 residents have a status of "Not Yet Assessable" and are not included in the analysis.

Specialty Box Plot Report - Milestone Evaluation by Resident Year: Year-End 2021-2022

SPECIALTY: Orthopaedic Surgery

7. Patient Care - Patient Care 7: Evaluation and Management of the Pediatric Orthopaedic Patient

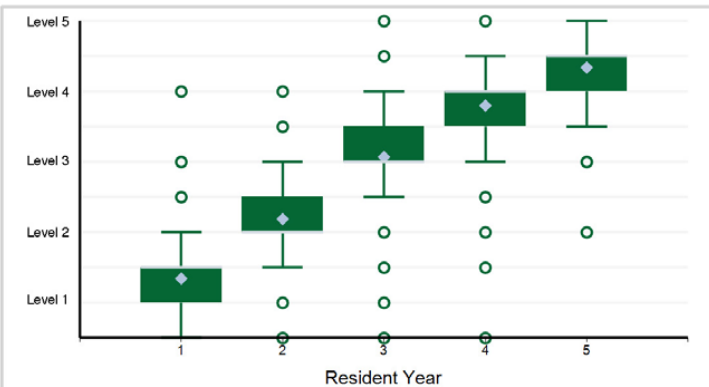

Note: 288 of 4,450 residents have a status of "Not Yet Assessable" and are not included in the analysis.

8. Medical Knowledge - Medical Knowledge 1: Orthopaedic Clinical Decision Making

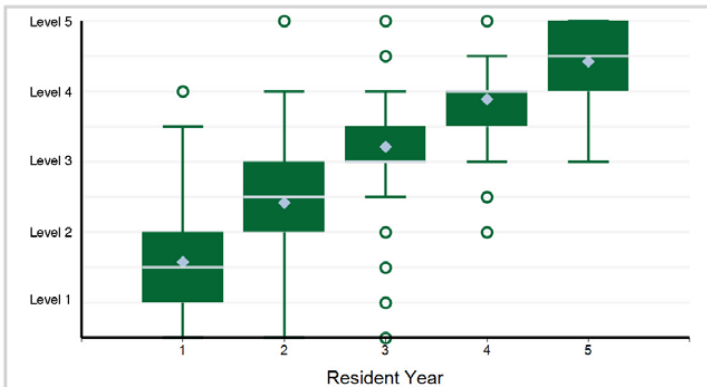

Note: 27 of 4,450 residents have a status of "Not Yet Assessable" and are not included in the analysis.

9. Medical Knowledge - Medical Knowledge 2: Anatomy and Physiology of Musculoskeletal Conditions

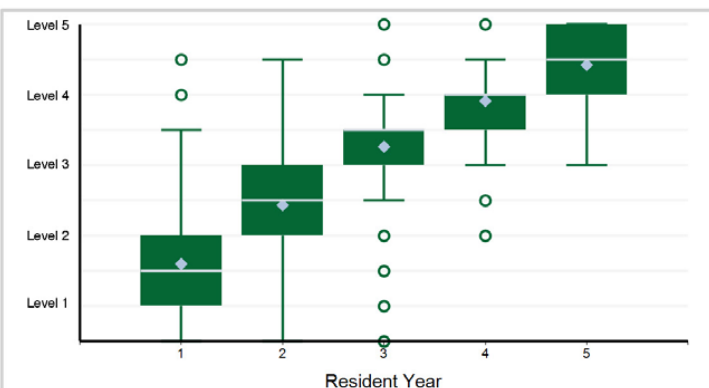

Note: 29 of 4,450 residents have a status of "Not Yet Assessable" and are not included in the analysis.

10. Systems-Based Practice - Systems-Based Practice 1: Patient Safety and Quality Improvement

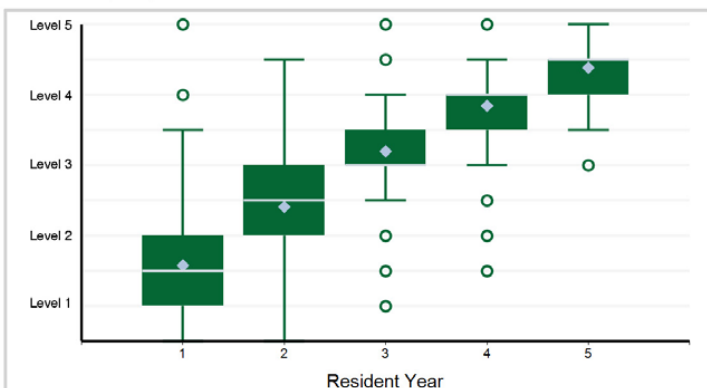

11. Systems-Based Practice - Systems-Based Practice 2: System Navigation for Patient-Centered Care

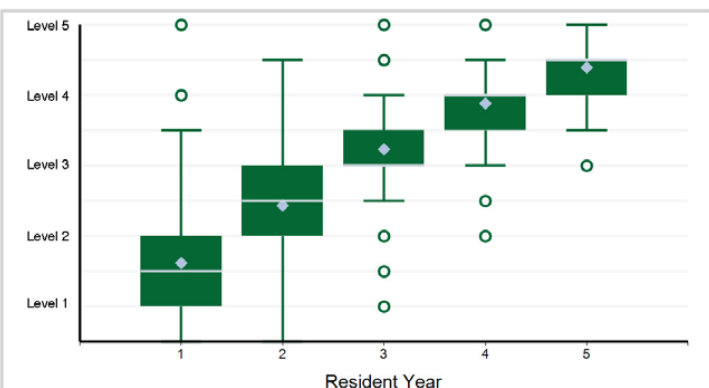

12. Systems-Based Practice - Systems-Based Practice 3: Physician Role in Health Care Systems

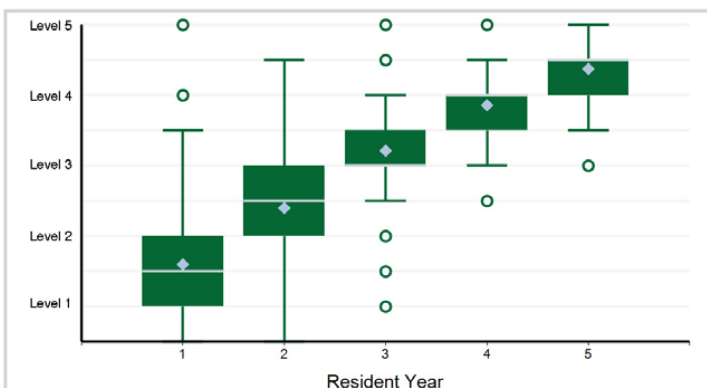

Specialty Box Plot Report - Milestone Evaluation by Resident Year: Year-End 2021-2022

SPECIALTY: Orthopaedic Surgery

13. Practice-Based Learning and Improvement - Practice-Based Learning and Improvement 1: Evidence-Based and Informed Practice

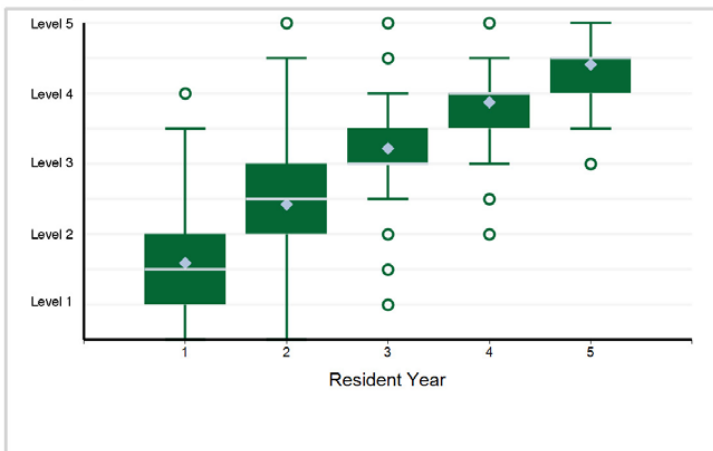

14. Practice-Based Learning and Improvement - Practice-Based Learning and Improvement 2: Reflective Practice and Commitment ...

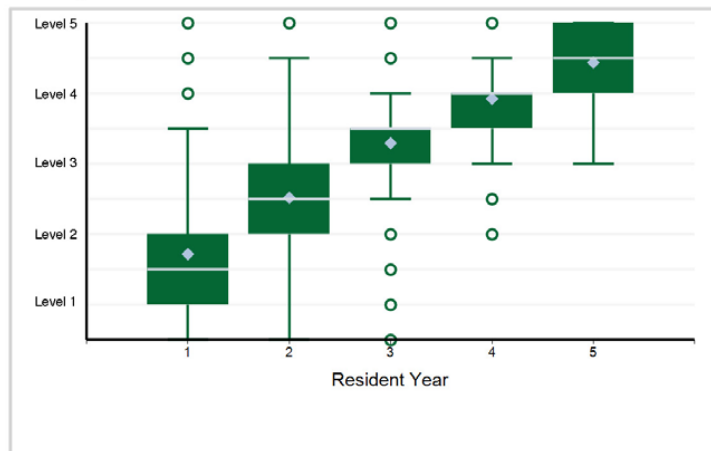

15. Professionalism - Professionalism 1: Professional Behavior and Ethical Principles

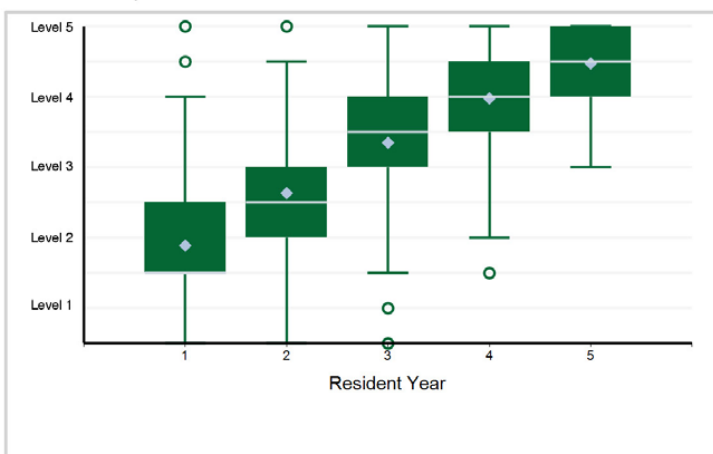

16. Professionalism - Professionalism 2: Accountability/Conscientiousness

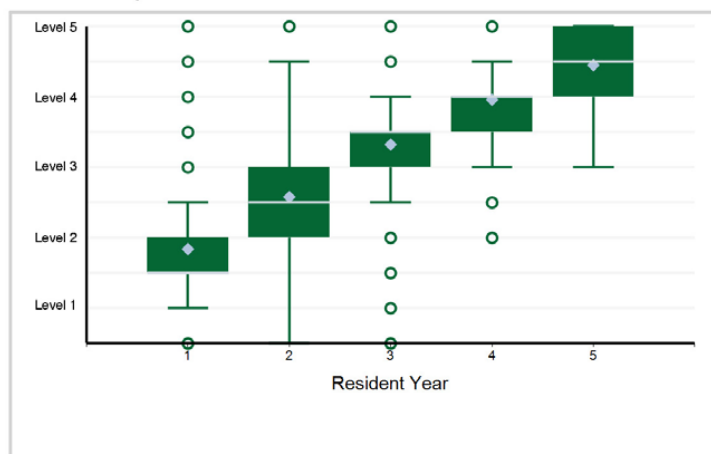

17. Professionalism - Professionalism 3: Well-Being

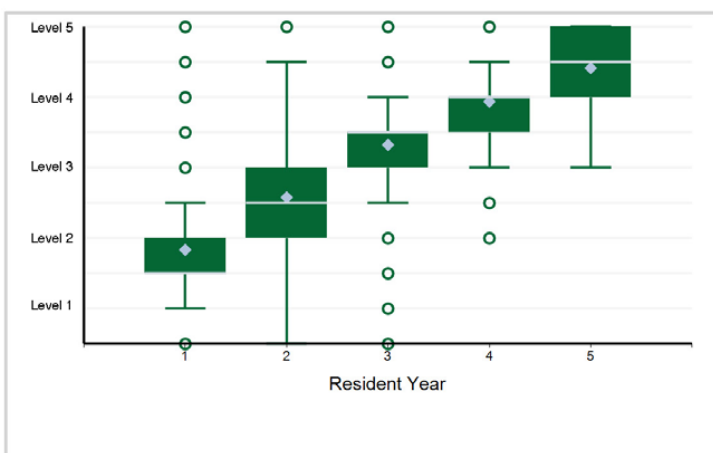

18. Interpersonal and Communication Skills - Interpersonal and Communication Skills 1: Patient- and Family-Centered Communication

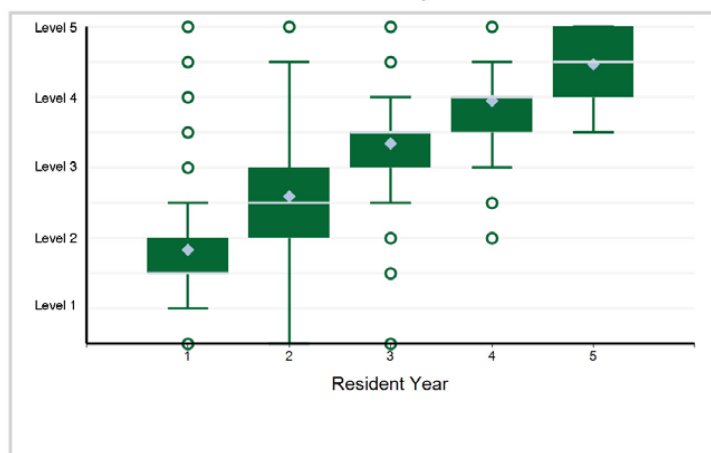

Specialty Box Plot Report - Milestone Evaluation by Resident Year: Year-End 2021-2022

SPECIALTY: Orthopaedic Surgery

19. Interpersonal and Communication Skills - Interpersonal and Communication Skills 2: Interprofessional and Team Communication

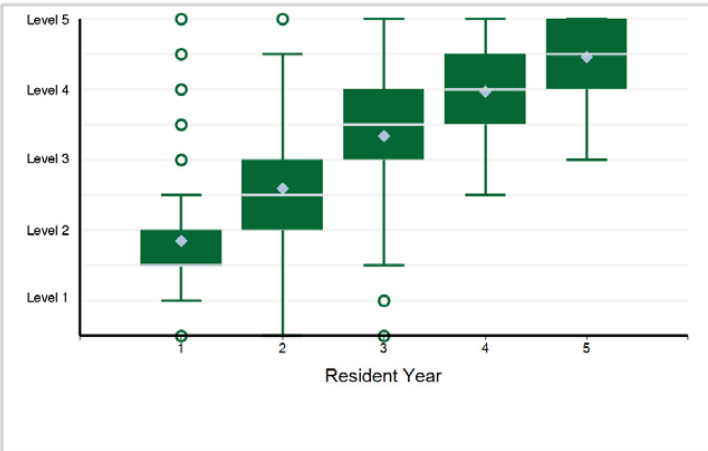

20. Interpersonal and Communication Skills - Interpersonal and Communication Skills 3: Communication within Health Care Systems

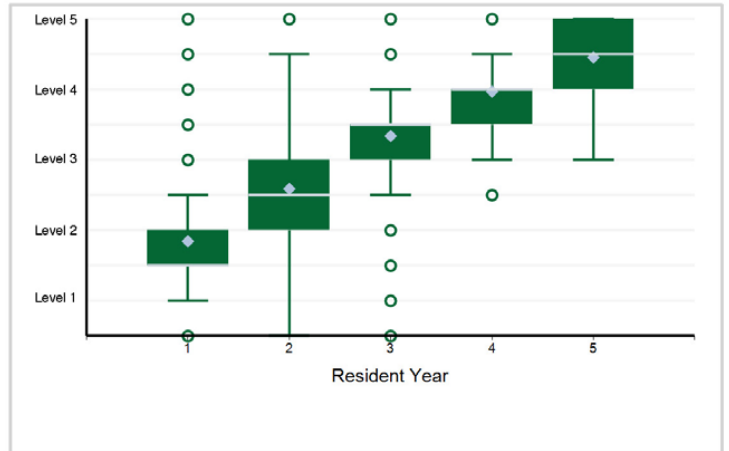

Specialty Box Plot Report - Milestone Evaluation by Resident Year: Year-End 2021-2022

TABLE 70: SUBSPECIALTY: **Adult Reconstructive Orthopaedic Surgery**

Resident Year	1	Total Residents*
# of Residents	53	53

*Note: There are 1 residents with an incomplete milestone evaluation that are excluded from the box plots below.

1. Patient Care - Knee Arthritis—Patient Care

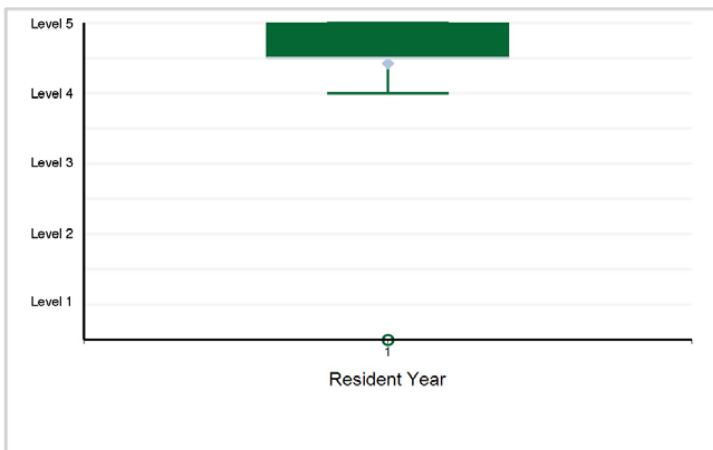

2. Patient Care - Knee Revisions—Patient Care

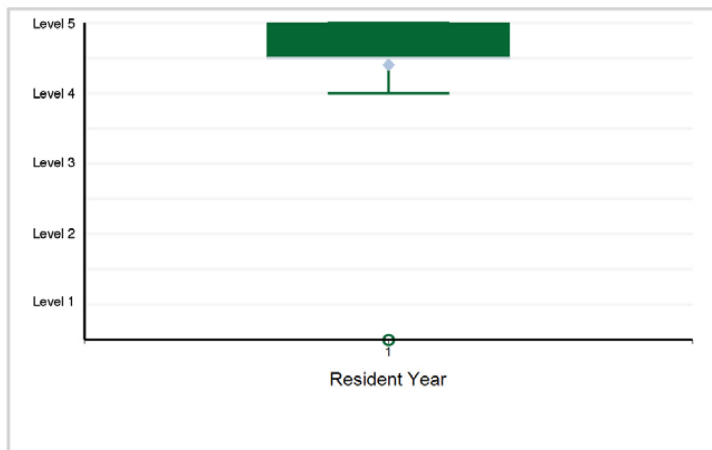

3. Patient Care - Hip Arthritis—Patient Care

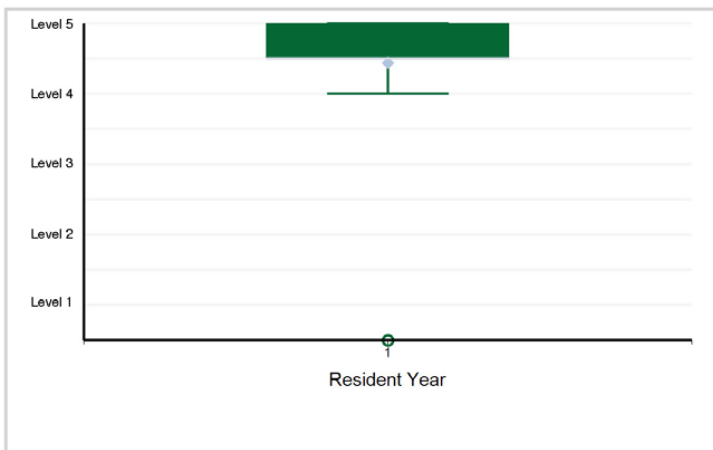

4. Patient Care - Hip Revision—Patient Care

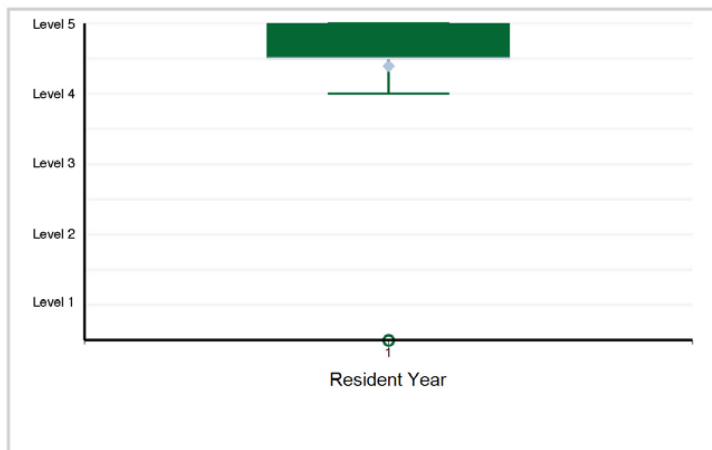

5. Patient Care - Shoulder Arthritis – Patient Care

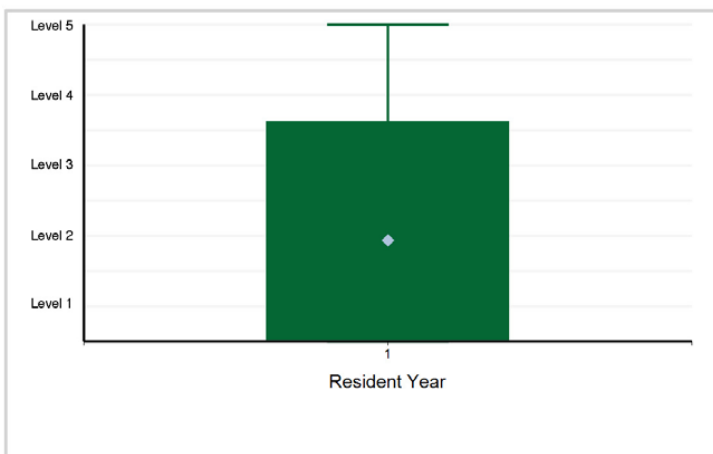

6. Patient Care - Shoulder Revisions – Patient Care

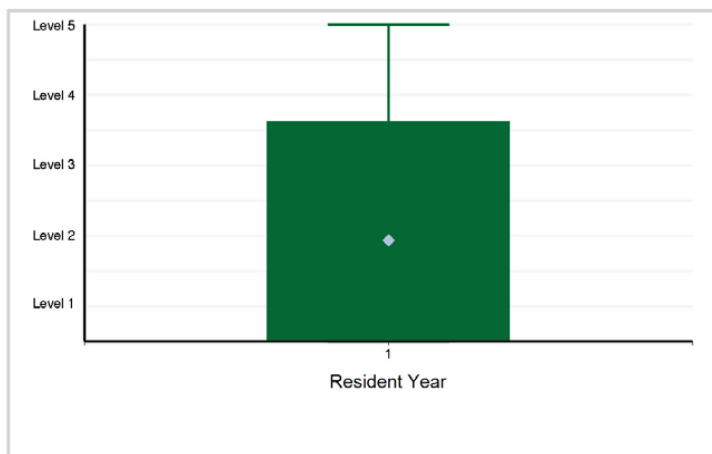

Specialty Box Plot Report - Milestone Evaluation by Resident Year: Year-End 2021-2022

SUBSPECIALTY: Adult Reconstructive Orthopaedic Surgery

7. Patient Care - Elbow Arthritis – Patient Care

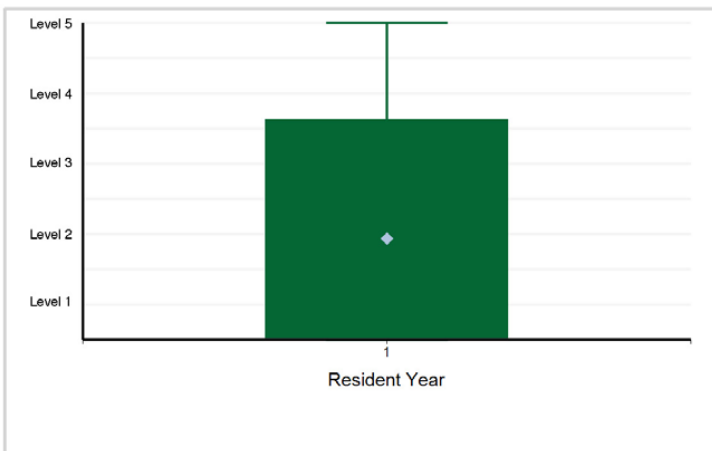

8. Medical Knowledge - Knee Arthritis—Medical Knowledge

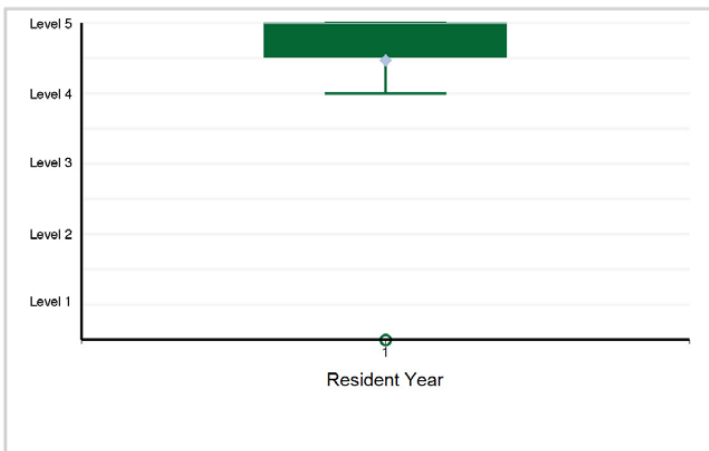

9. Medical Knowledge - Knee Revision—Medical Knowledge

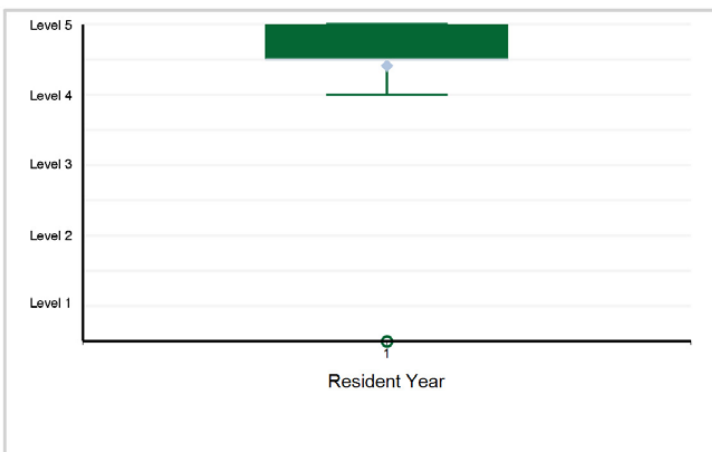

10. Medical Knowledge - Hip Arthritis—Medical Knowledge

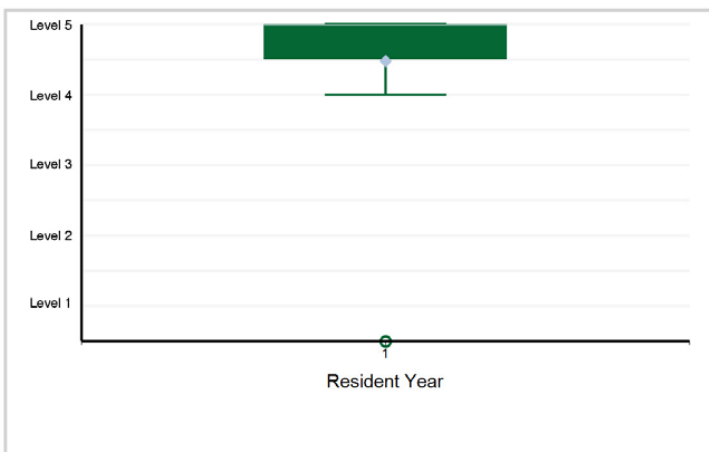

11. Medical Knowledge - Hip Revision—Medical Knowledge

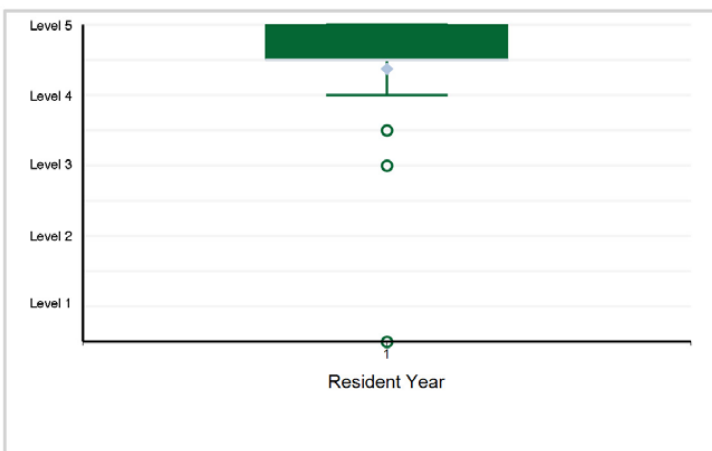

12. Medical Knowledge - Shoulder Arthritis – Medical Knowledge

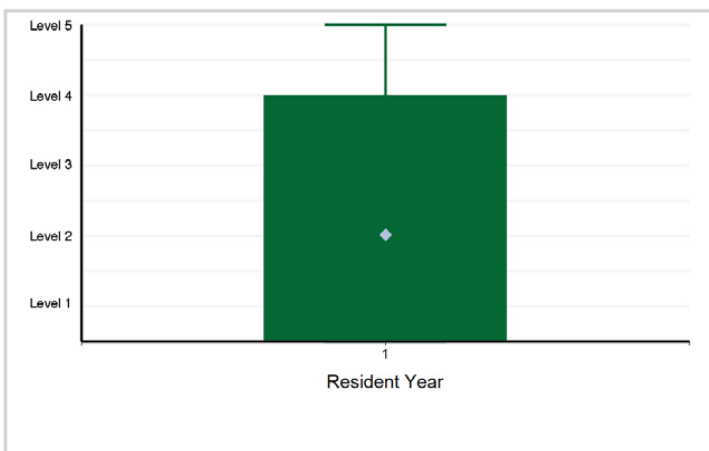

Specialty Box Plot Report - Milestone Evaluation by Resident Year: Year-End 2021-2022

SUBSPECIALTY: Adult Reconstructive Orthopaedic Surgery

13. Medical Knowledge - Shoulder Revision – Medical Knowledge

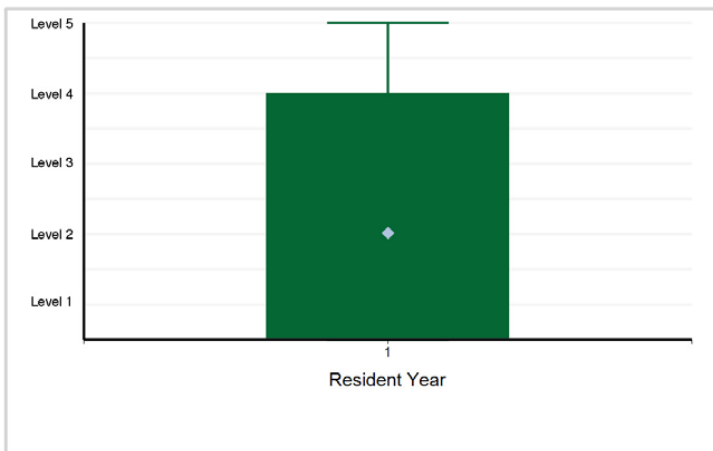

14. Medical Knowledge - Elbow Arthritis – Medical Knowledge

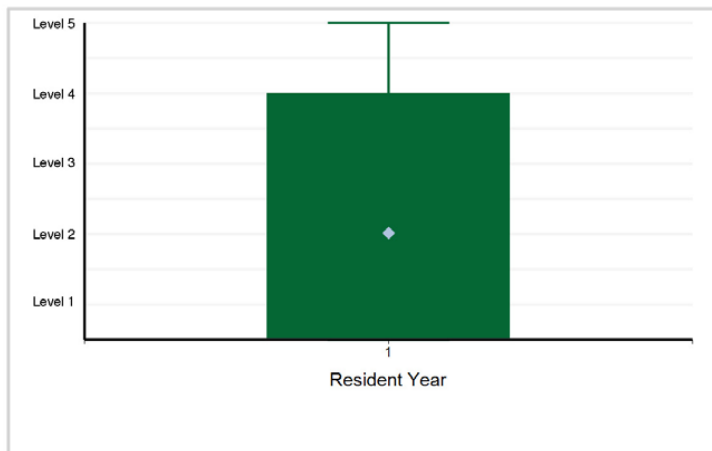

15. Systems-Based Practice - Systems thinking, including cost-effective practice—Systems-Based Practice

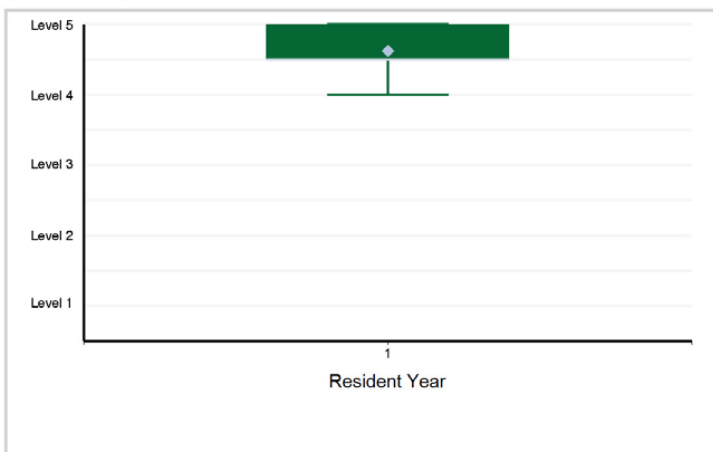

16. Systems-Based Practice - Works in interprofessional teams to enhance patient safety and quality care—Systems-Based Practice

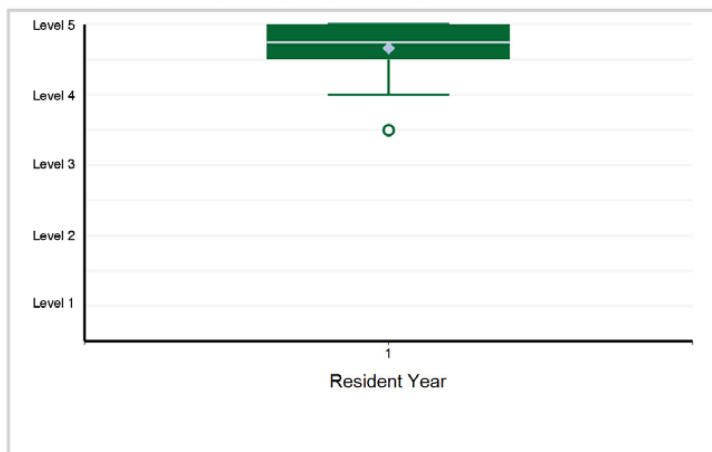

17. Systems-Based Practice - Uses technology to accomplish safe health care delivery—Systems-Based Practice

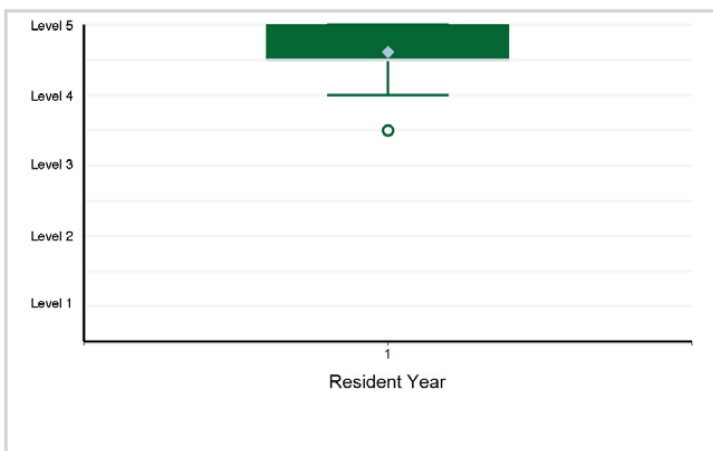

18. Practice-Based Learning and Improvement - Self-directed Learning—Practice-Based Learning and Improvement ...

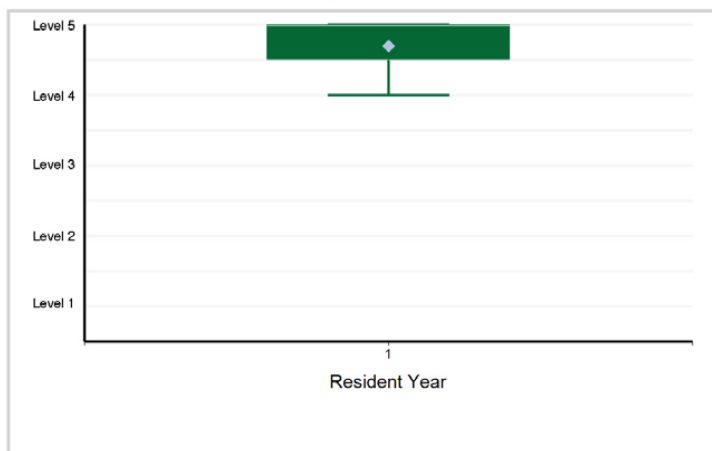

Specialty Box Plot Report - Milestone Evaluation by Resident Year: Year-End 2021-2022

SUBSPECIALTY: Adult Reconstructive Orthopaedic Surgery

19. Practice-Based Learning and Improvement - Locate, appraise, and assimilate evidence from scientific ...

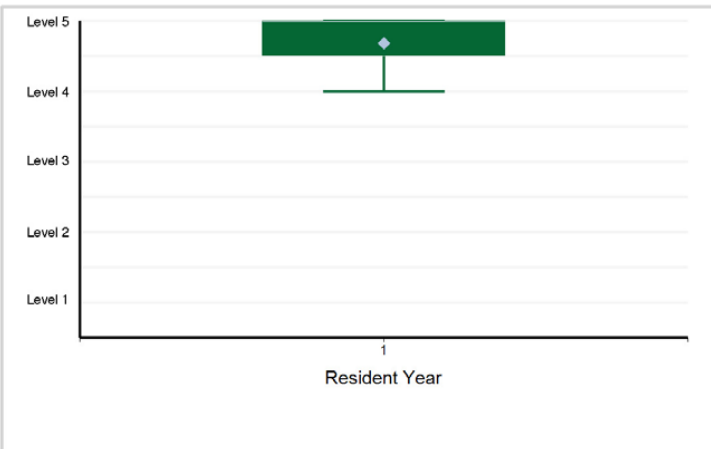

20. Professionalism - Compassion, integrity, and respect for others, as well as sensitivity and responsiveness ...

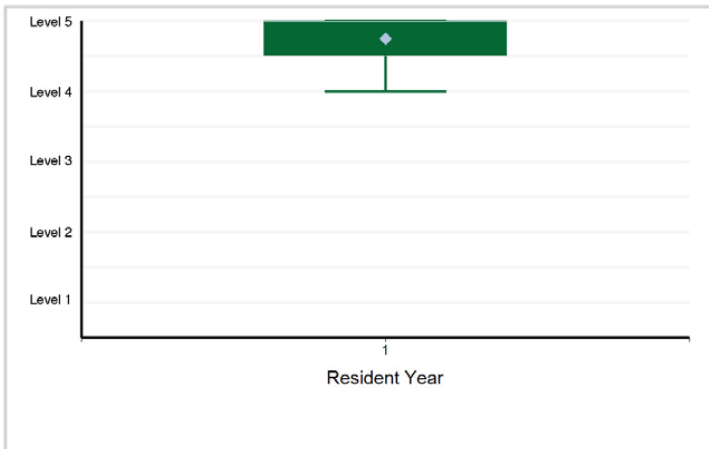

21. Professionalism - Accountability to patients, society, and the profession; personal responsibility to ...

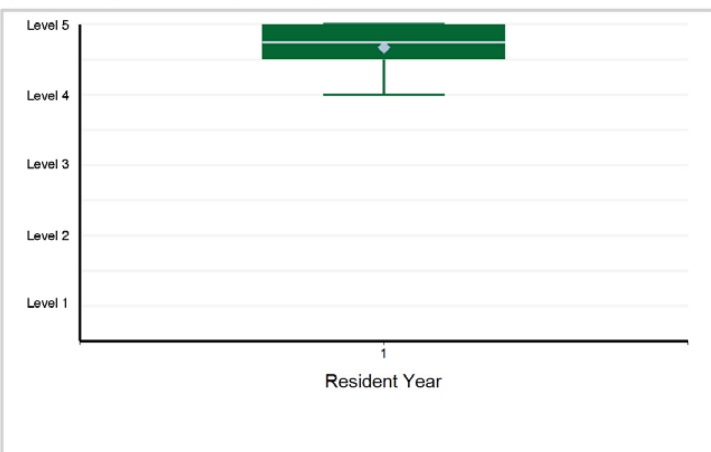

22. Interpersonal and Communication Skills - Communication—Interpersonal and Communication Skills

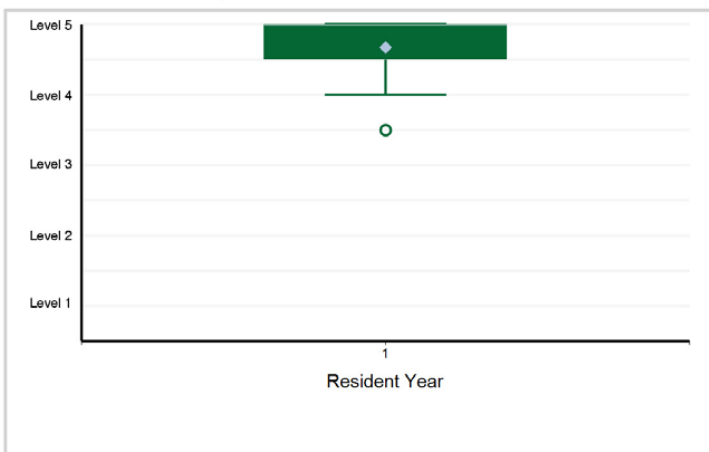

23. Interpersonal and Communication Skills - Teamwork (e.g., physician, nursing and allied health care providers, ...)

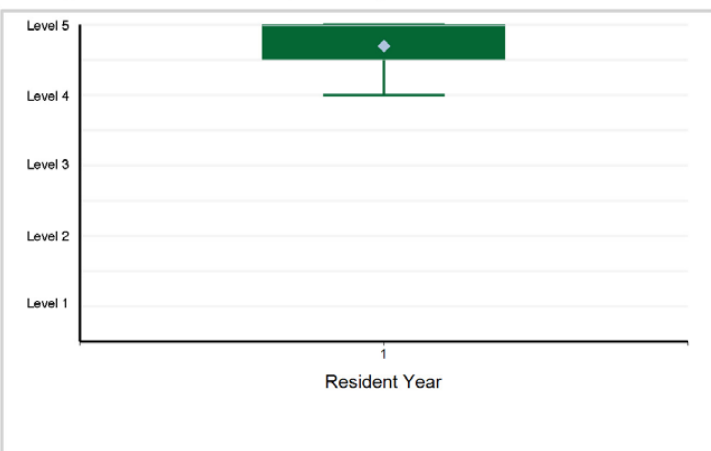

Specialty Box Plot Report - Milestone Evaluation by Resident Year: Year-End 2021-2022

TABLE 71: SUBSPECIALTY: **Foot and Ankle Orthopaedic Surgery**

Resident Year	1	Total Residents
# of Residents	16	16

1. Patient Care - Achilles Disorders—Patient Care

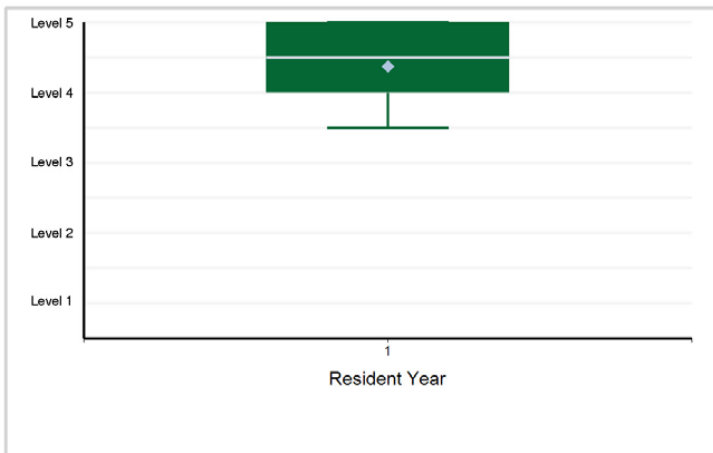

2. Medical Knowledge - Achilles Disorder — Medical Knowledge

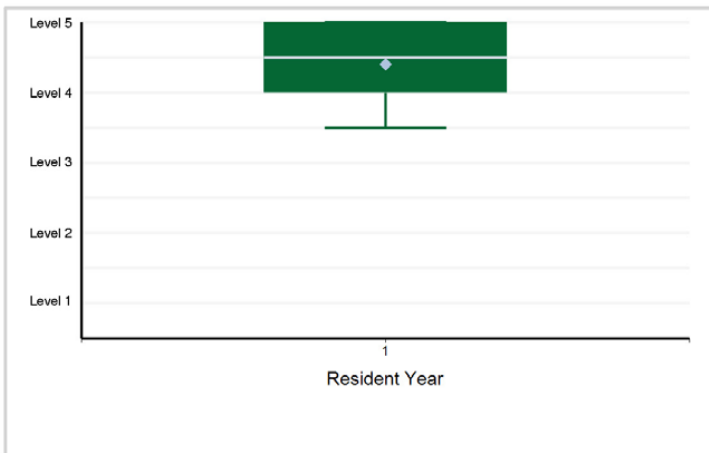

3. Patient Care - Ankle Arthritis—Patient Care

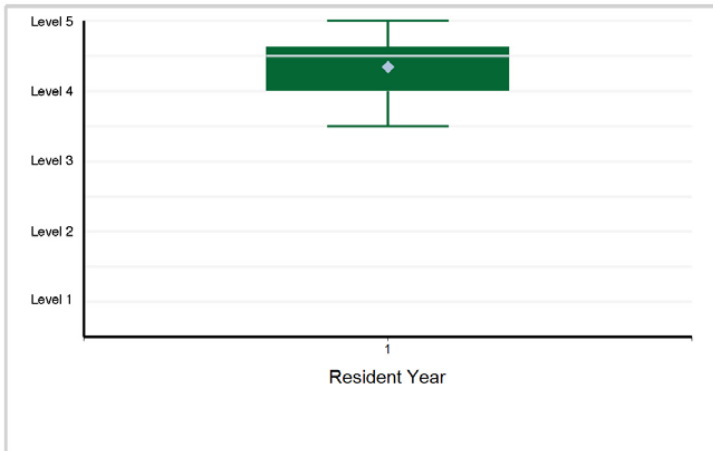

4. Medical Knowledge - Ankle Arthritis—Medical Knowledge

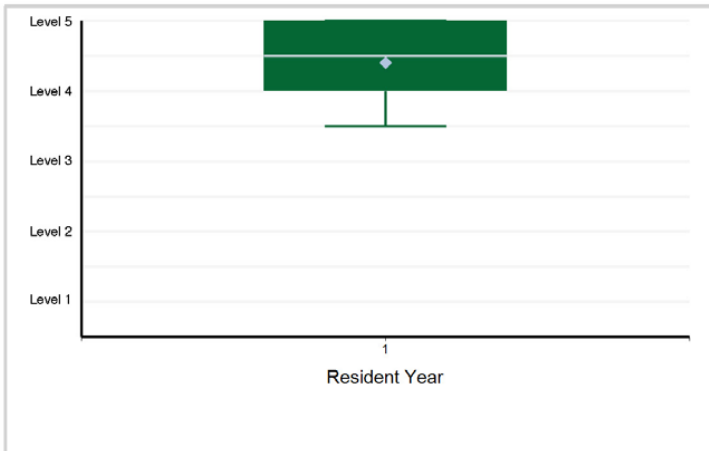

5. Patient Care - Calcaneus Fractures—Patient Care



6. Medical Knowledge - Calcaneus Fractures—Medical Knowledge

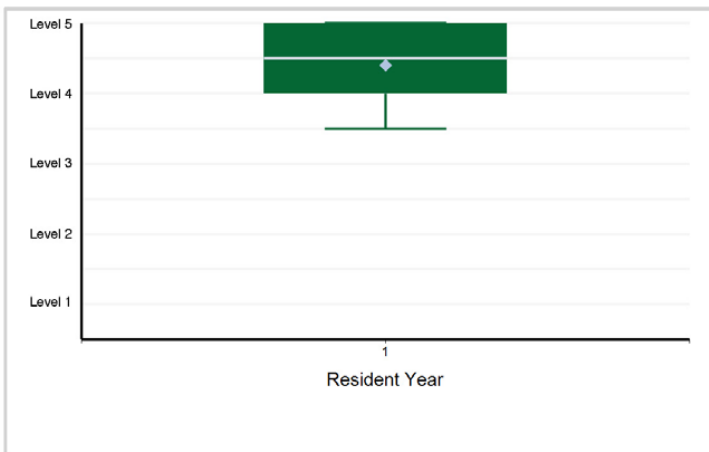

Specialty Box Plot Report - Milestone Evaluation by Resident Year: Year-End 2021-2022

SUBSPECIALTY: Foot and Ankle Orthopaedic Surgery

7. Patient Care - Diabetic Foot—Patient Care

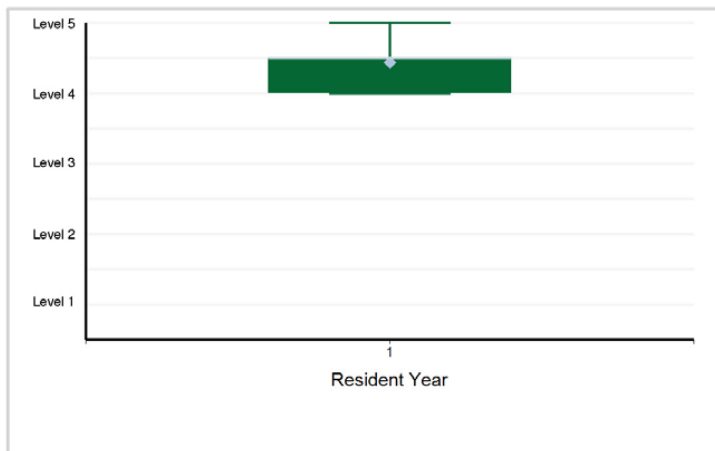

8. Medical Knowledge - Diabetic Foot—Medical Knowledge

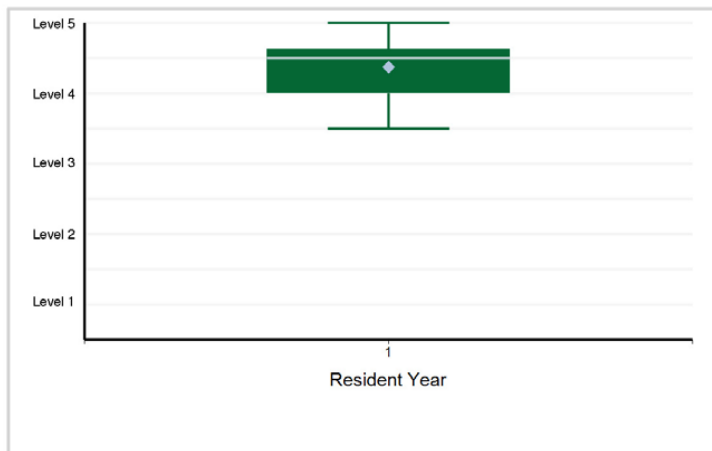

9. Patient Care - Hallux Valgus—Patient Care

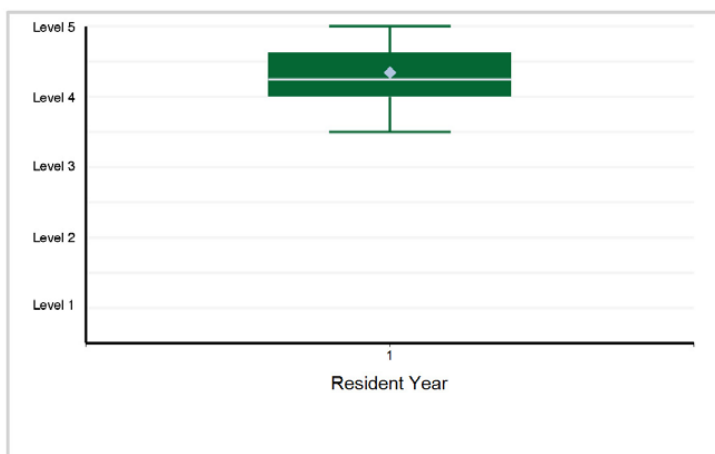

10. Medical Knowledge - Hallux Valgus—Medical Knowledge

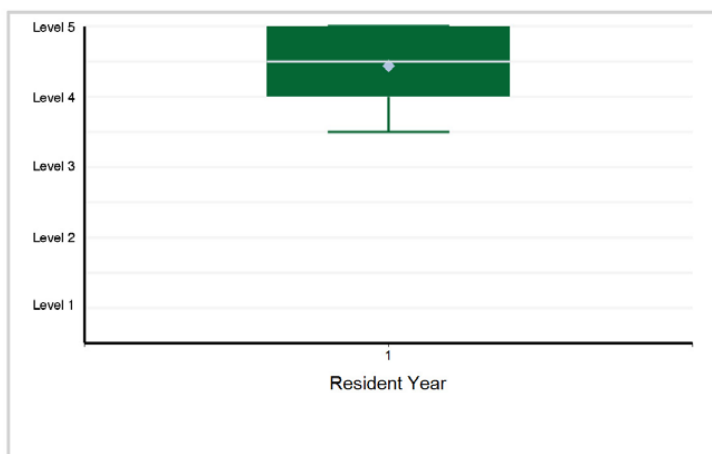

11. Patient Care - Ankle Arthroscopy: Osteochondritis Dissecans (OCD) Talus—Patient Care

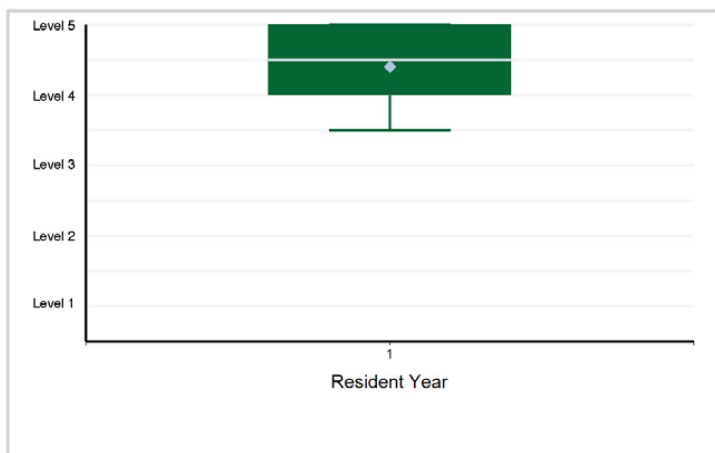

12. Medical Knowledge - Ankle Arthroscopy: Osteochondral Defects of the Talus—Medical Knowledge

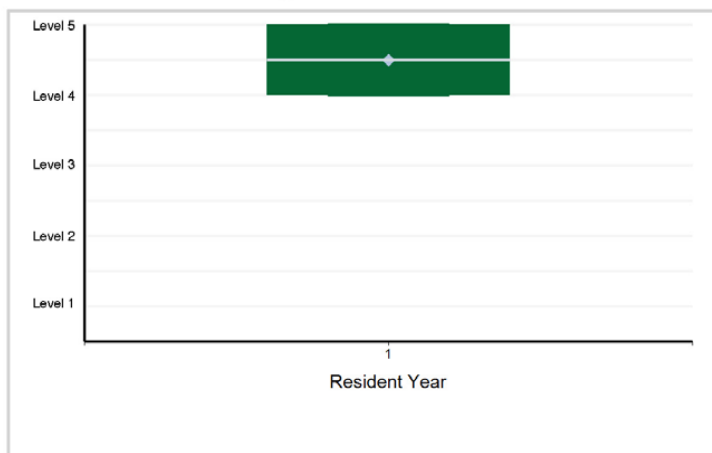

Specialty Box Plot Report - Milestone Evaluation by Resident Year: Year-End 2021-2022

SUBSPECIALTY: Foot and Ankle Orthopaedic Surgery

13. Patient Care - Pes Cavus—Patient Care

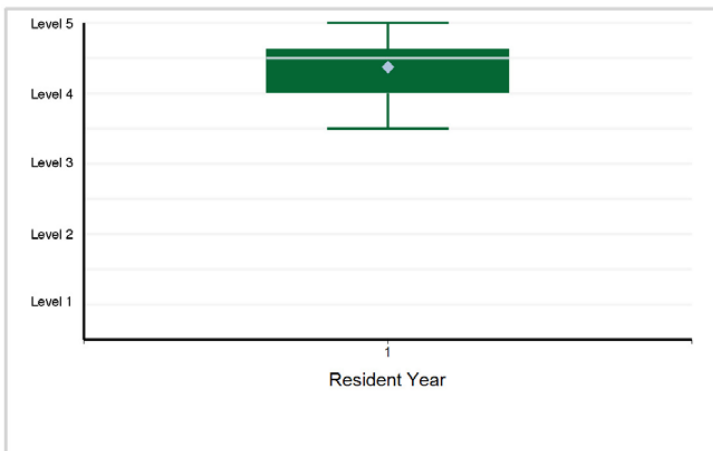

14. Medical Knowledge - Pes Cavus—Medical Knowledge

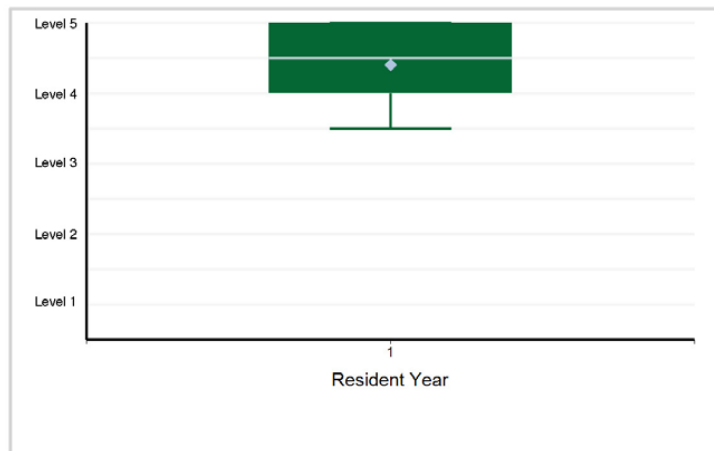

15. Patient Care - Pes Planovalgus—Patient Care

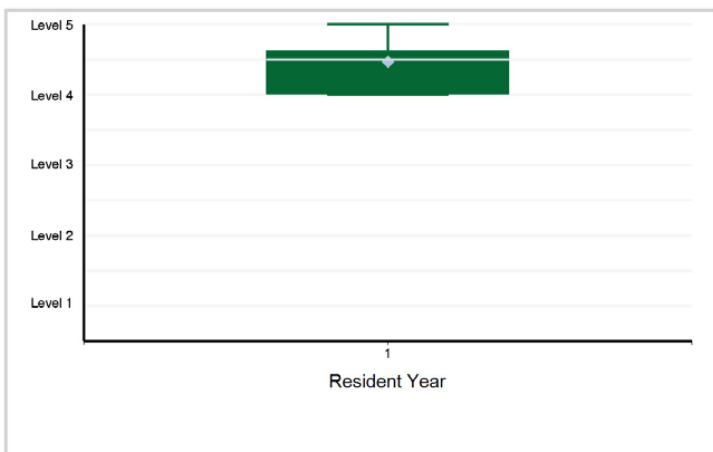

16. Medical Knowledge - Pes Planovalgus—Medical Knowledge

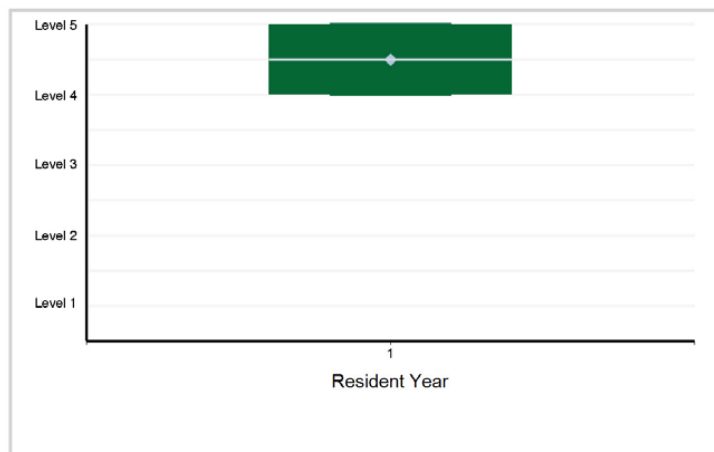

17. Systems-Based Practice - Interprofessional Teams—Systems-Based Practice

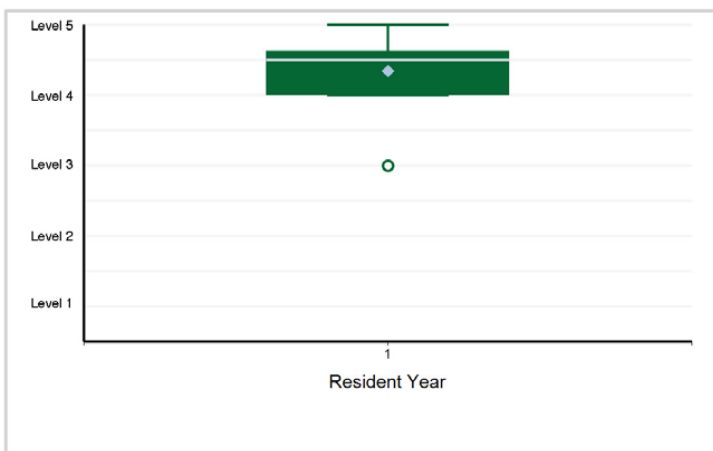

18. Systems-Based Practice - Use of technology to accomplish safe health care delivery—Systems-Based Practice

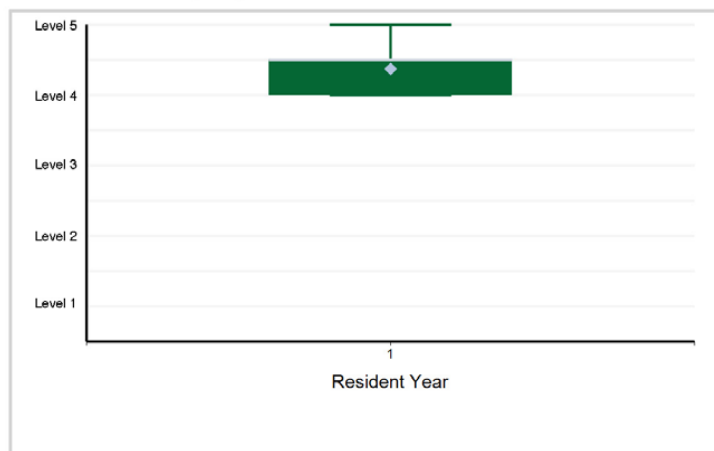

Specialty Box Plot Report - Milestone Evaluation by Resident Year: Year-End 2021-2022

SUBSPECIALTY: Foot and Ankle Orthopaedic Surgery

19. Systems-Based Practice - Systems thinking, including cost-effective practice—Systems-Based Practice

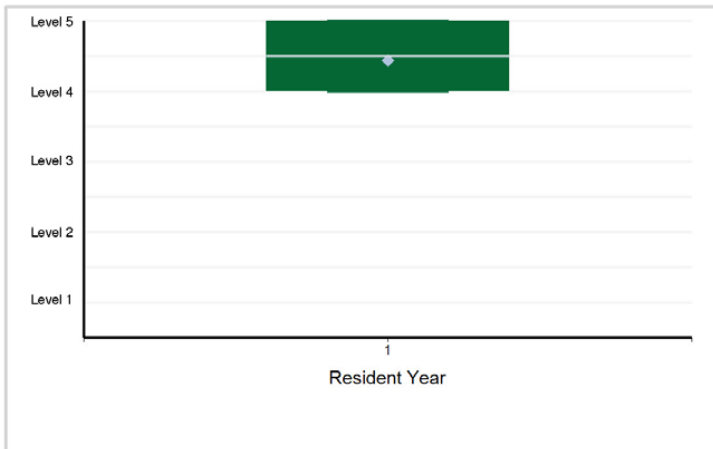

20. Practice-Based Learning and Improvement - Locate, appraise, and assimilate evidence to improve patient ...

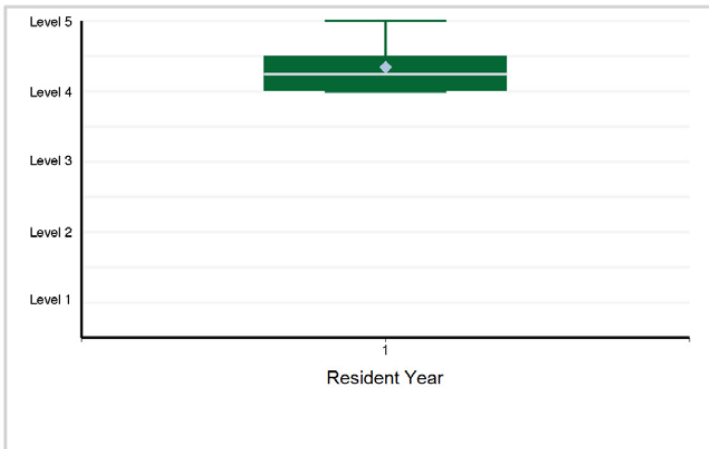

21. Professionalism - Accountability and Responsibility—Professionalism

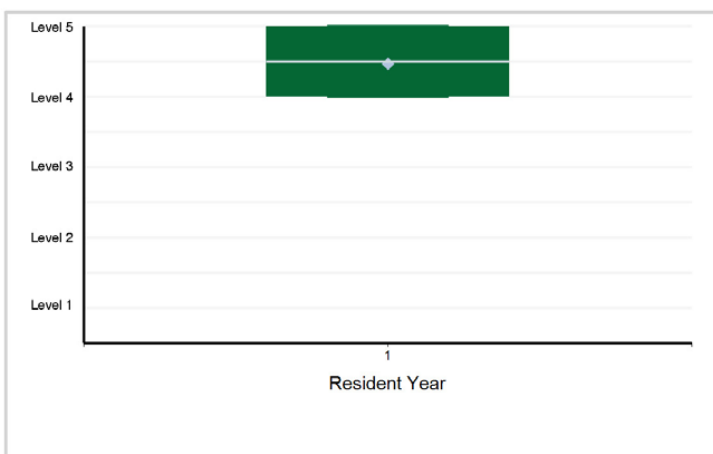

22. Professionalism - Compassion, Integrity, and Respect for others—Professionalism

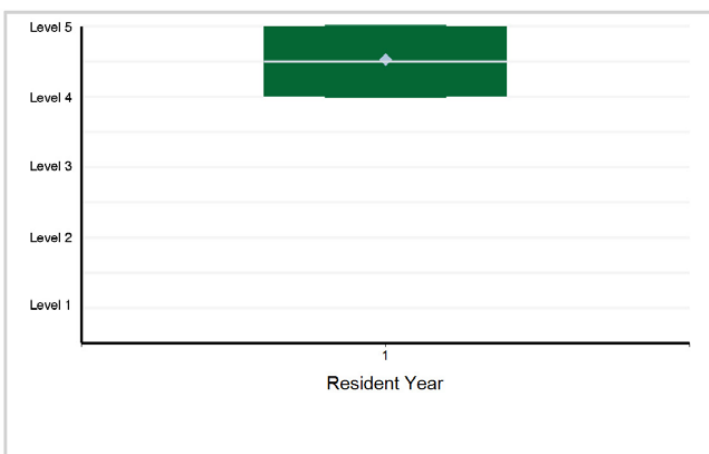

23. Interpersonal and Communication Skills - Communication—Interpersonal and Communication Skills

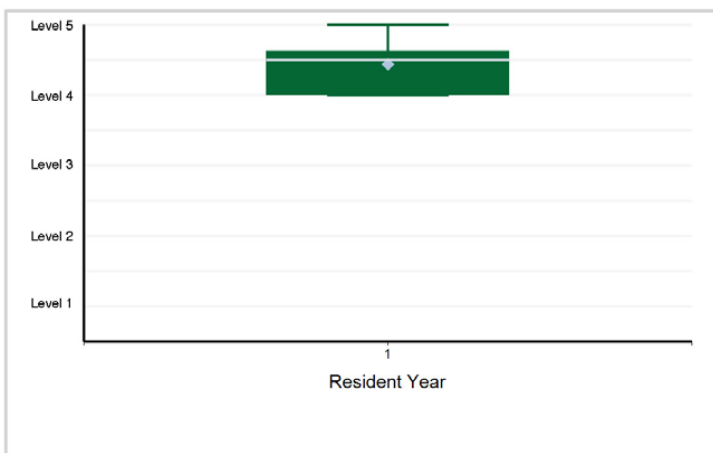

24. Interpersonal and Communication Skills - Teamwork—Interpersonal and Communication Skills

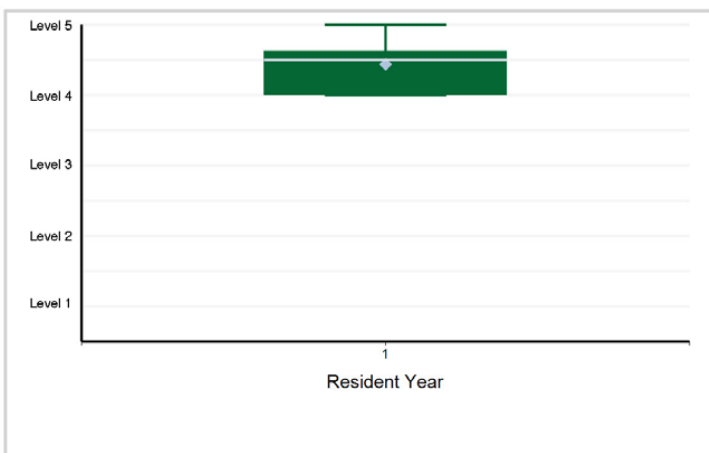

Specialty Box Plot Report - Milestone Evaluation by Resident Year: Year-End 2021-2022

TABLE 72: SUBSPECIALTY: **Hand Surgery (multidisciplinary, Orthopaedic Surgery)**

Resident Year	1	Total Residents
# of Residents	156	156

1. Patient Care - Acquired Conditions (Tumor, Dupuytren's, tenosynovitis, vascular, contractures) — Patient Care

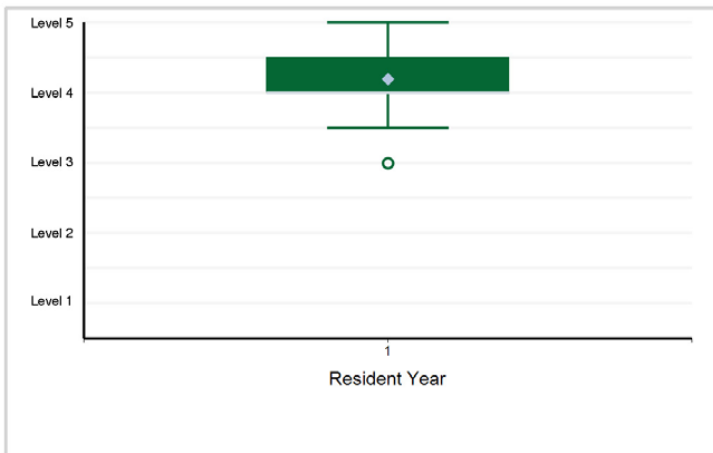

2. Medical Knowledge - Acquired Conditions (Tumor, Dupuytren's, tenosynovitis, vascular, contractures) — Medical Knowledge

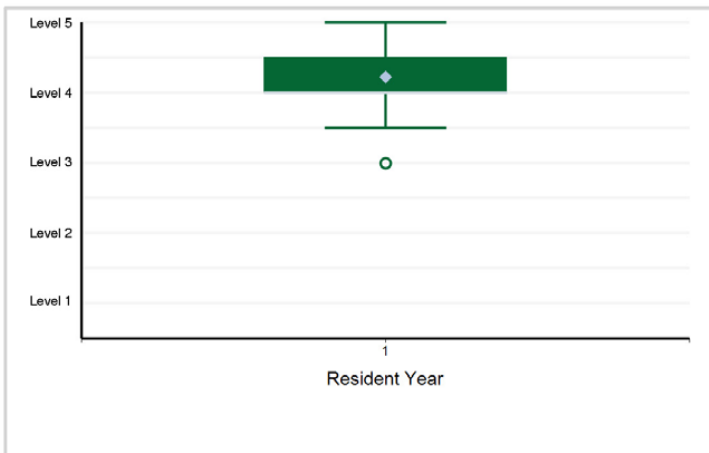

3. Patient Care - Arthritis — Patient Care

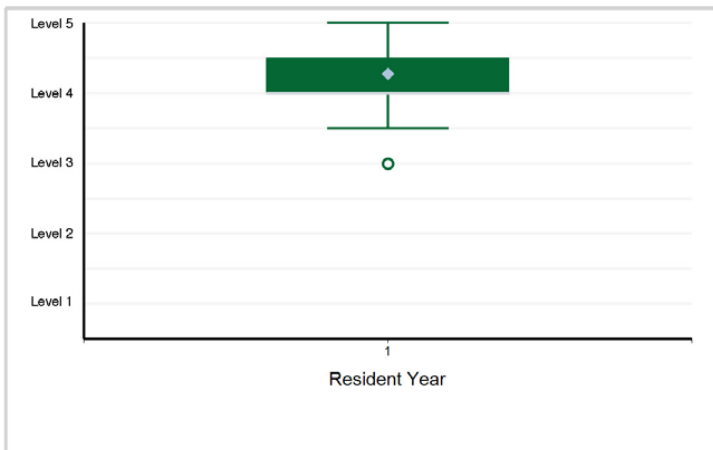

4. Medical Knowledge - Arthritis — Medical Knowledge

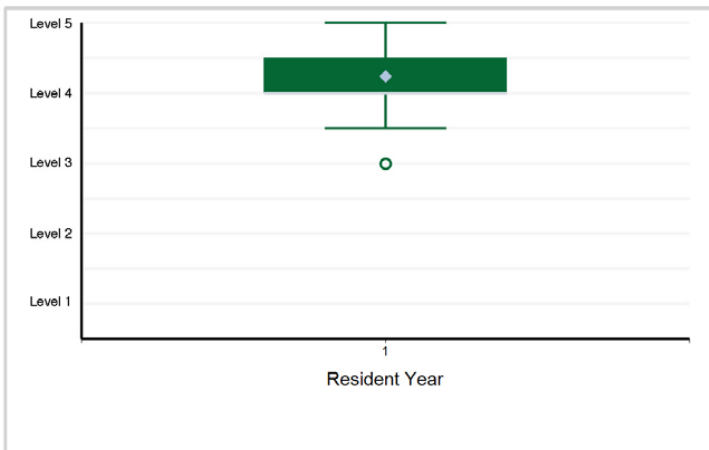

5. Patient Care - Congenital — Patient Care

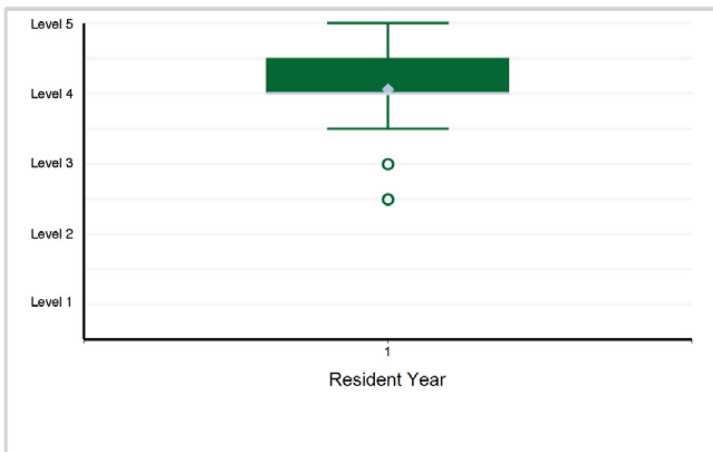

6. Medical Knowledge - Congenital — Medical Knowledge

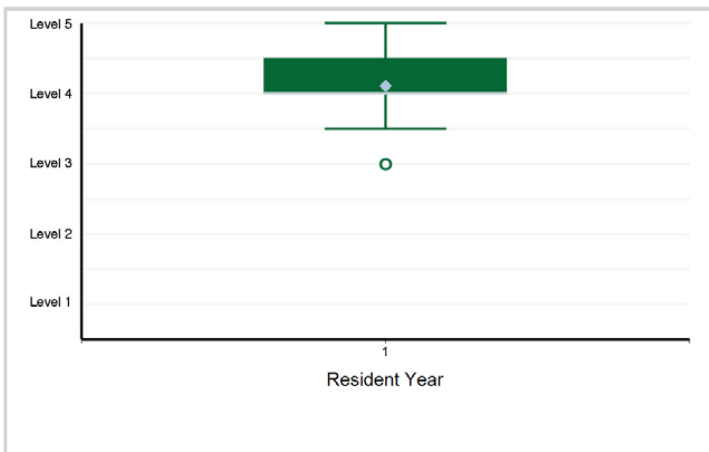

Specialty Box Plot Report - Milestone Evaluation by Resident Year: Year-End 2021-2022

SUBSPECIALTY: **Hand Surgery (multidisciplinary, Orthopaedic Surgery)**

7. Patient Care - Nerve — Patient Care

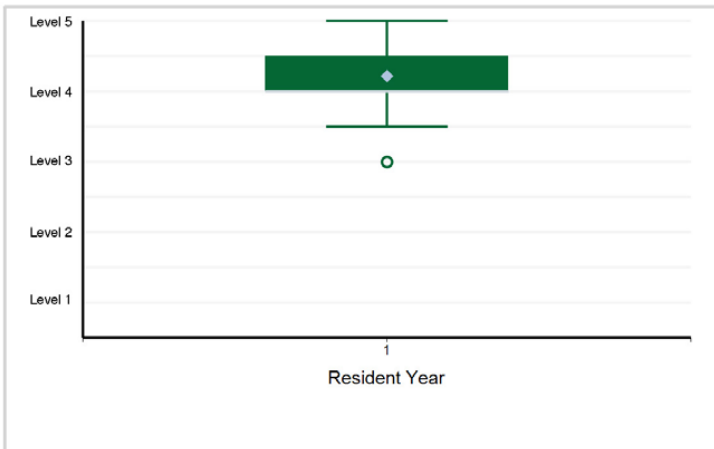

8. Medical Knowledge - Nerve — Medical Knowledge

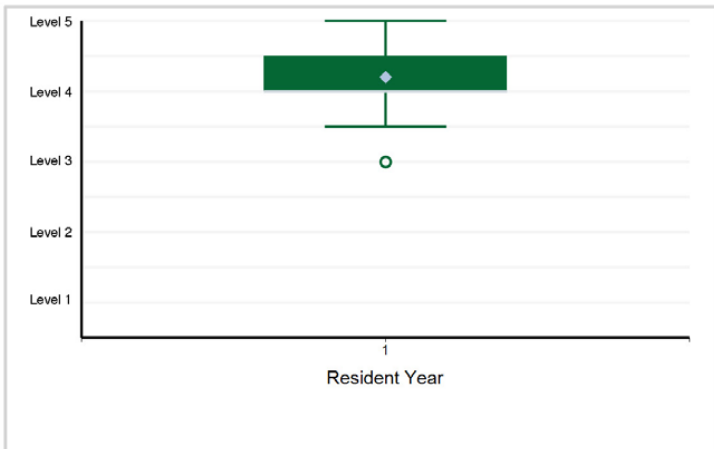

9. Patient Care - Trauma: Bone, Joint — Patient Care

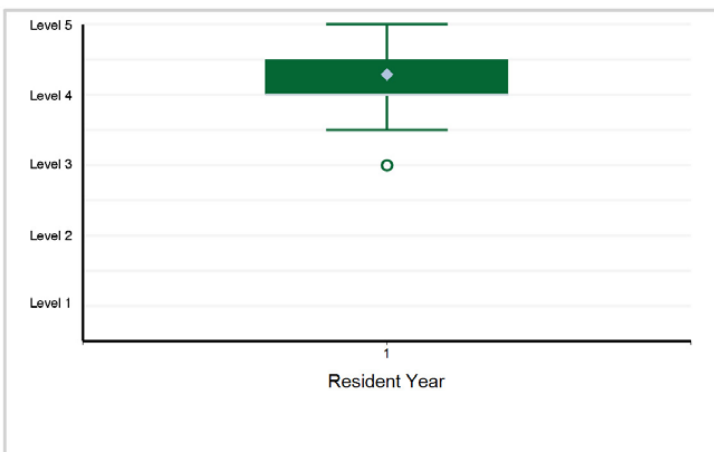

10. Medical Knowledge - Trauma: Bone, Joint — Medical Knowledge

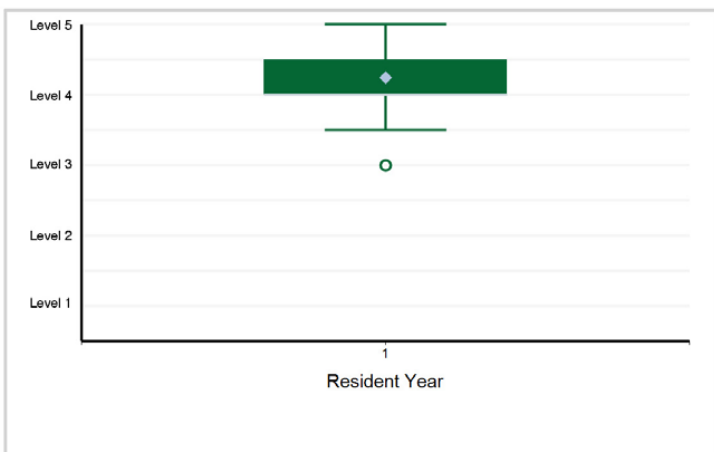

11. Patient Care - Soft Tissue Trauma, Infections — Patient Care

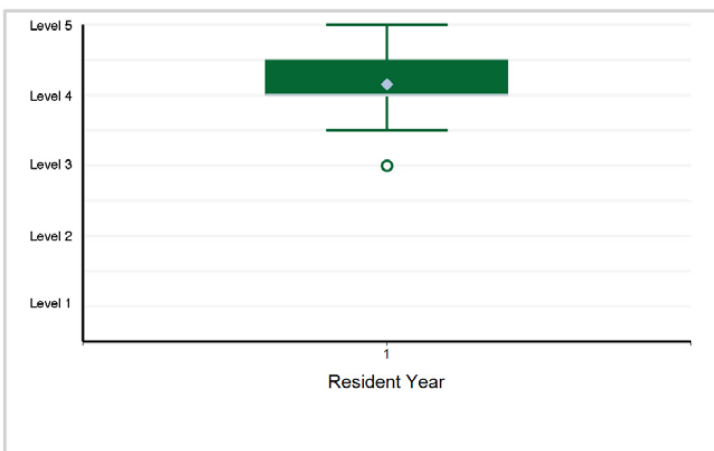

12. Medical Knowledge - Soft Tissue Trauma, Infections — Medical Knowledge

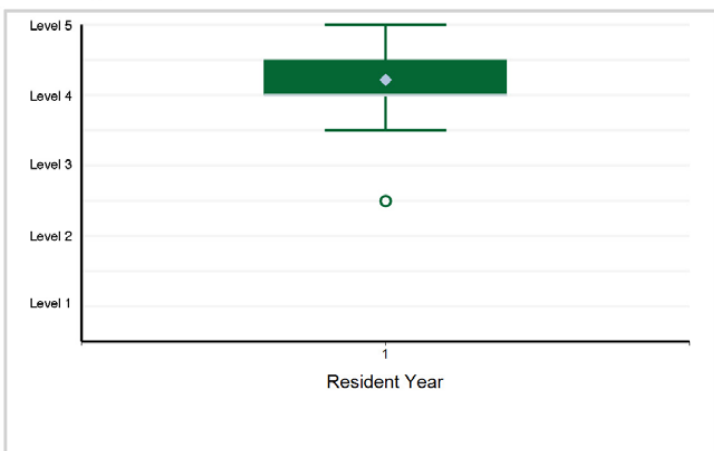

Specialty Box Plot Report - Milestone Evaluation by Resident Year: Year-End 2021-2022

SUBSPECIALTY: Hand Surgery (multidisciplinary, Orthopaedic Surgery)

13. Patient Care - Tendon — Patient Care

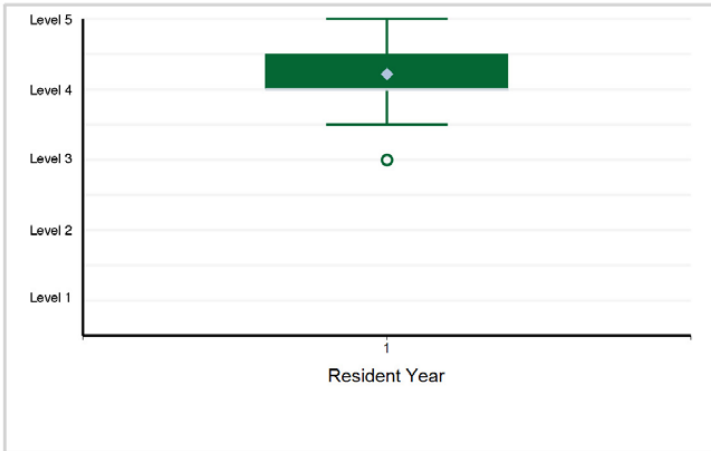

14. Medical Knowledge - Tendon — Medical Knowledge

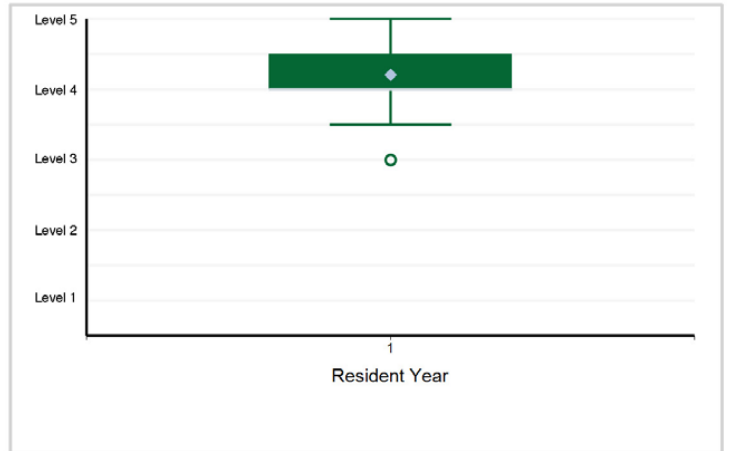

15. Systems-Based Practice - Patient Safety, Resource Allocation, Practice Management — Systems-Based Practice

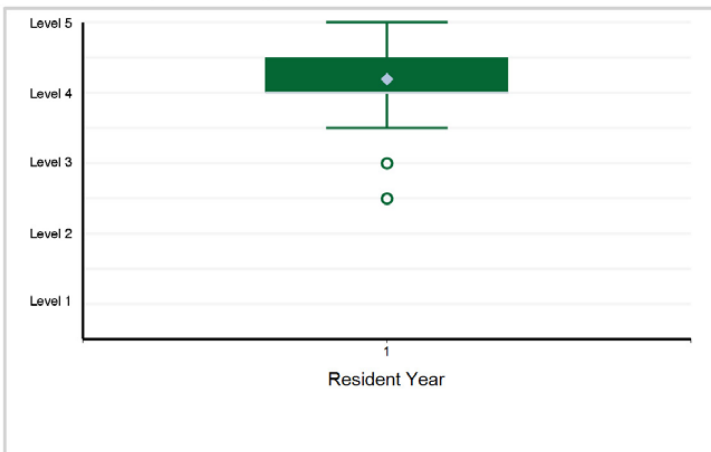

16. Practice-Based Learning and Improvement - The ability to investigate and evaluate the care of patients, to appraise and ...

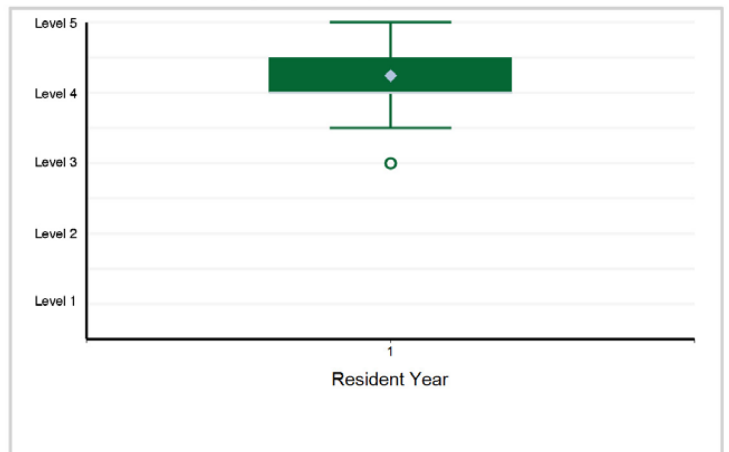

17. Professionalism - Ethics and Values — Professionalism

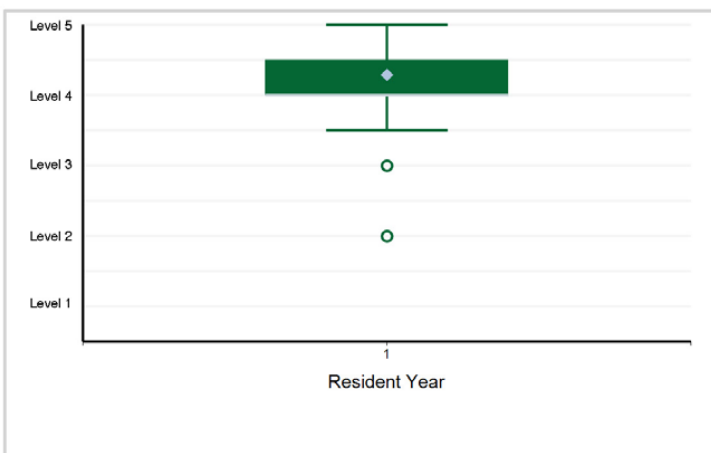

18. Interpersonal and Communication Skills - Interpersonal and Communication Skills

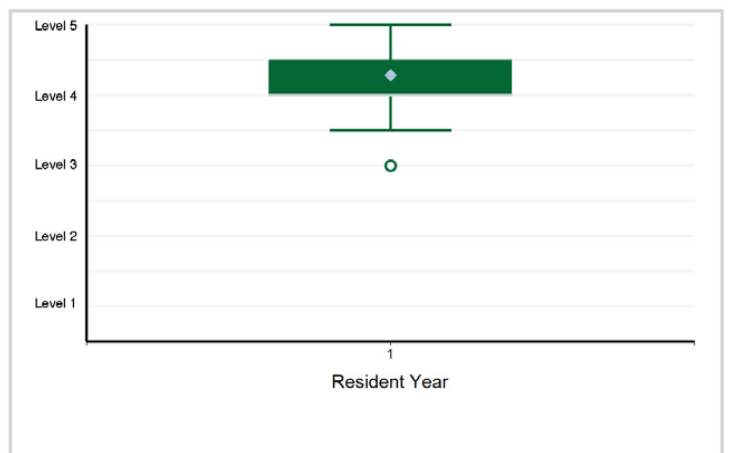

Specialty Box Plot Report - Milestone Evaluation by Resident Year: Year-End 2021-2022

TABLE 73: SUBSPECIALTY: **Musculoskeletal Oncology**

Resident Year	1	Total Residents
# of Residents	16	16

1. Patient Care - Metastatic Bone Lesion—Patient Care

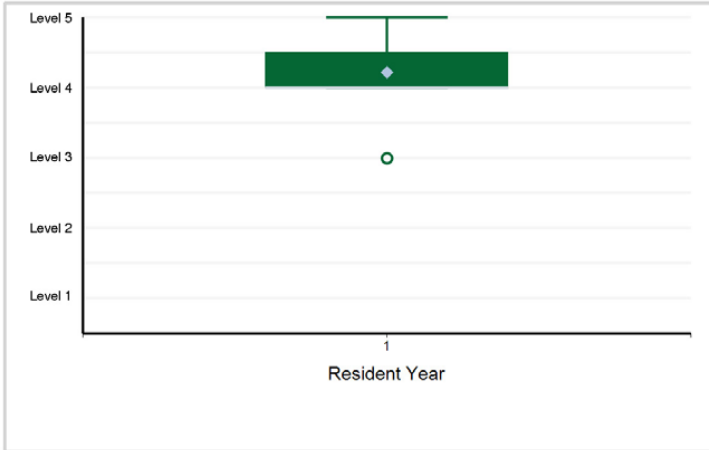

2. Medical Knowledge - Metastatic Bone Lesion—Medical Knowledge

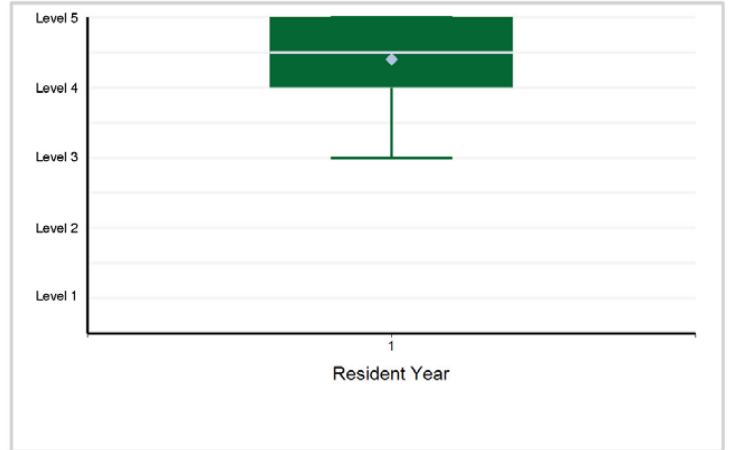

3. Patient Care - Malignant Bone Lesion (Primary)—Patient Care

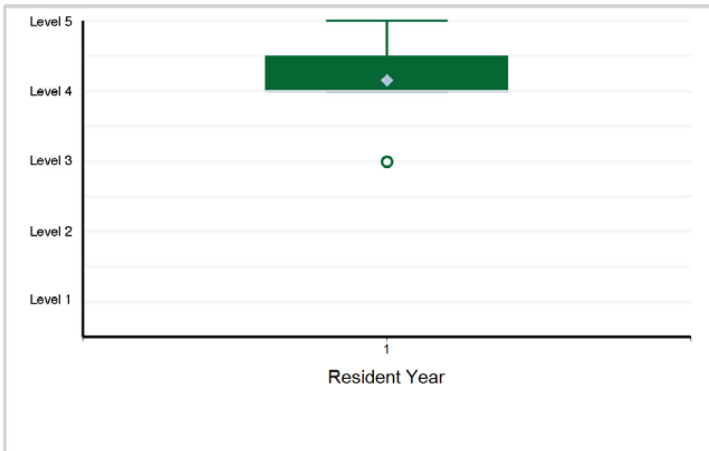

4. Medical Knowledge - Malignant Bone (Primary)—Medical Knowledge

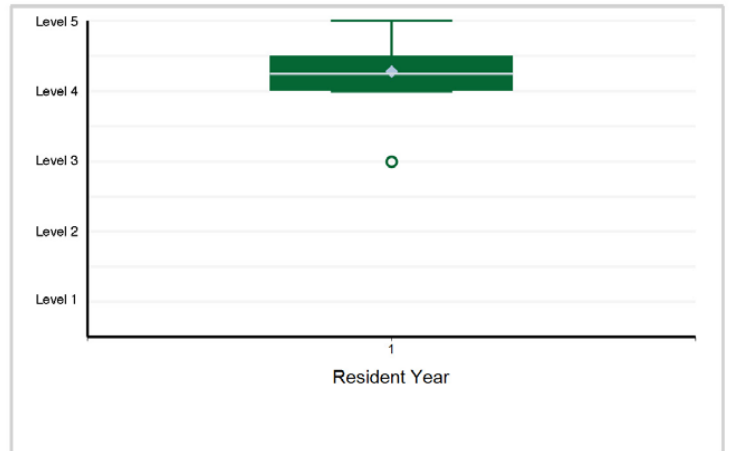

5. Patient Care - Malignant Soft Tissue Tumor—Patient Care

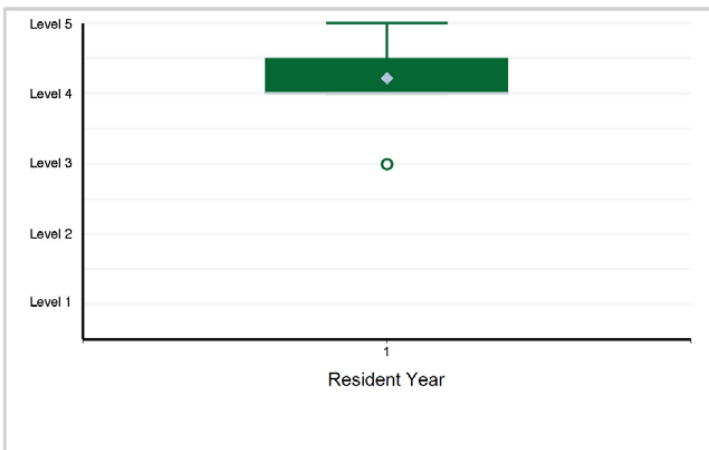

6. Medical Knowledge - Malignant Soft Tissue Tumor—Medical Knowledge

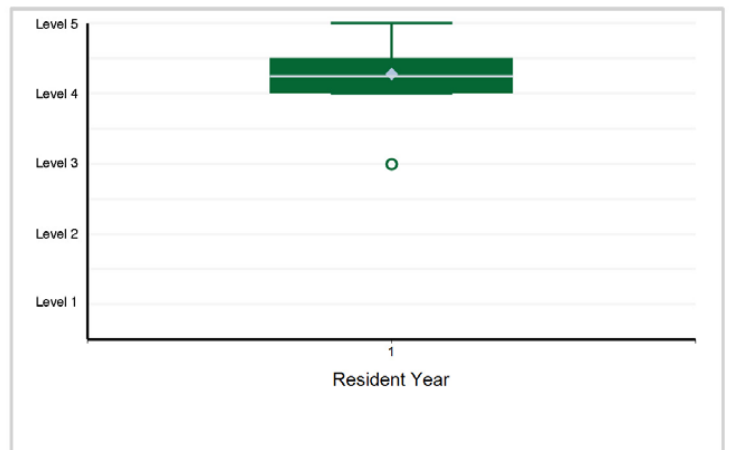

Specialty Box Plot Report - Milestone Evaluation by Resident Year: Year-End 2021-2022

SUBSPECIALTY: Musculoskeletal Oncology

7. Patient Care - Benign Bone Tumor—Patient Care

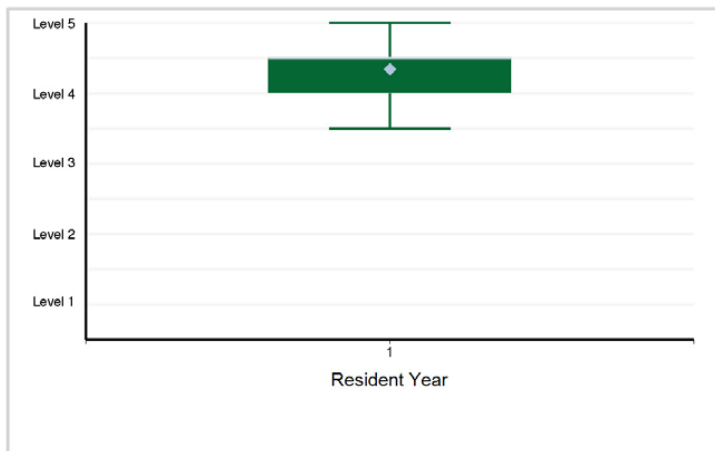

8. Medical Knowledge - Benign Bone Tumor—Medical Knowledge

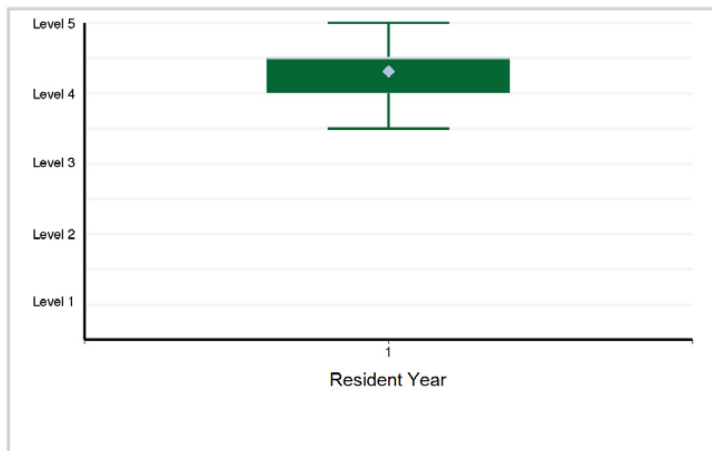

9. Patient Care - Benign Soft Tissue Tumor—Patient Care

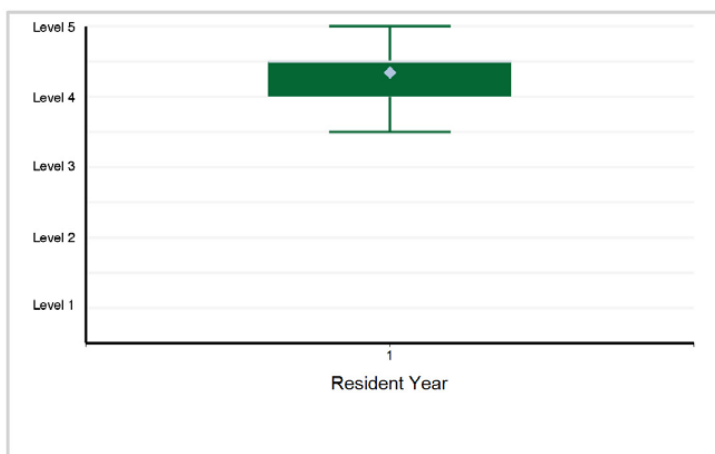

10. Medical Knowledge - Benign Soft Tissue Tumor—Medical Knowledge

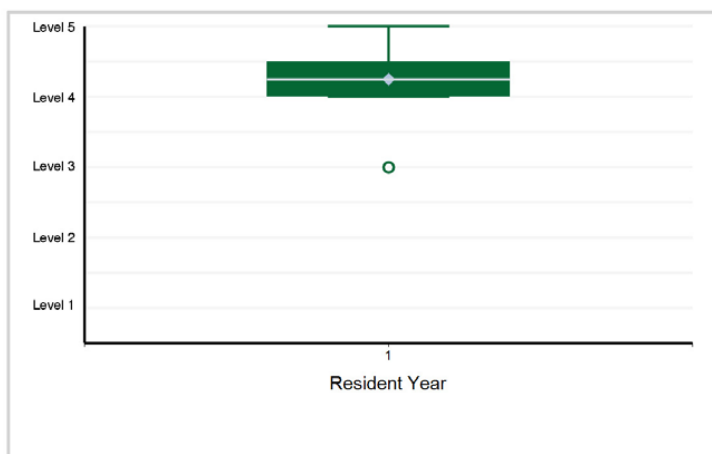

11. Systems-Based Practice - Systems thinking, including cost-effective practice—Systems-based Practice



12. Systems-Based Practice - Fellow will work in interprofessional teams to enhance patient safety and quality ...

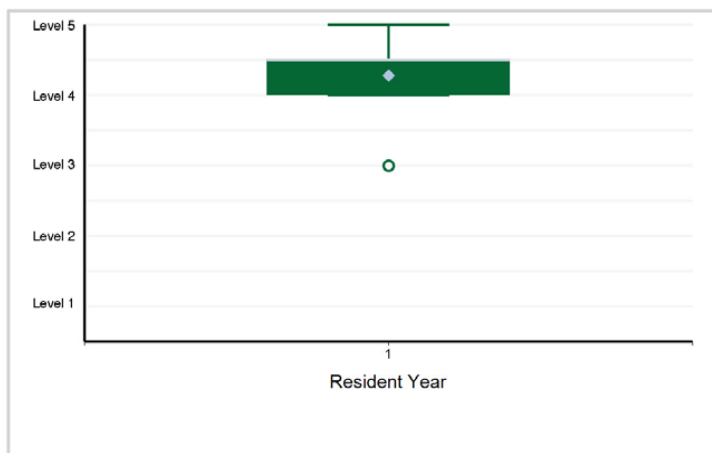

Specialty Box Plot Report - Milestone Evaluation by Resident Year: Year-End 2021-2022

SUBSPECIALTY: Musculoskeletal Oncology

13. Systems-Based Practice - Uses technology to accomplish safe health care delivery—Systems-based Practice

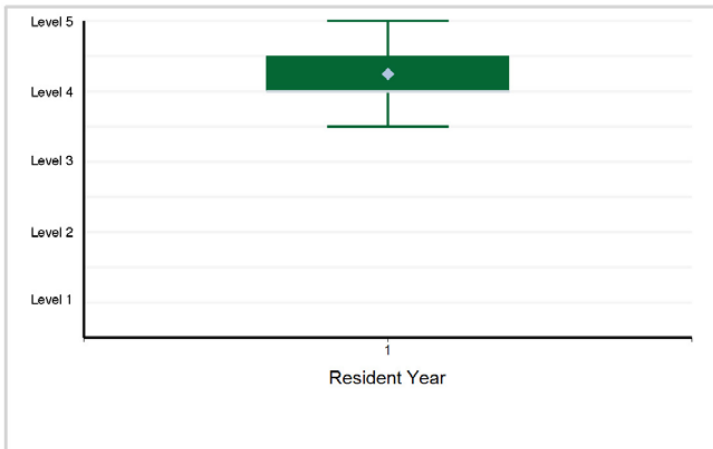

14. Practice-Based Learning and Improvement - Self-Directed Learning—Practice-based Learning and Improvement ...

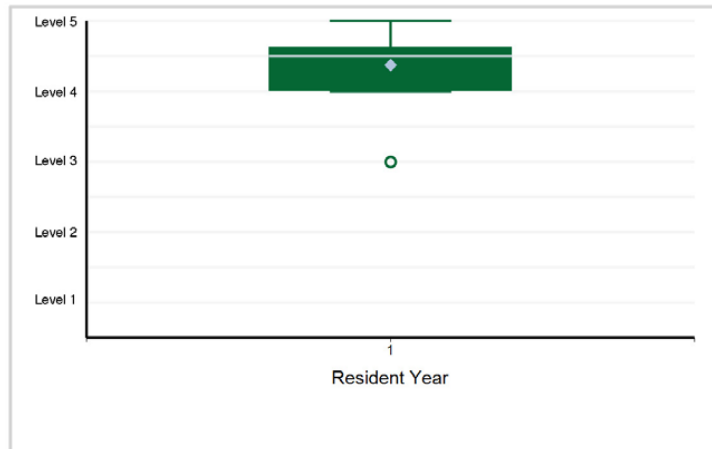

15. Practice-Based Learning and Improvement - Locate, appraise, and assimilate evidence from scientific ...

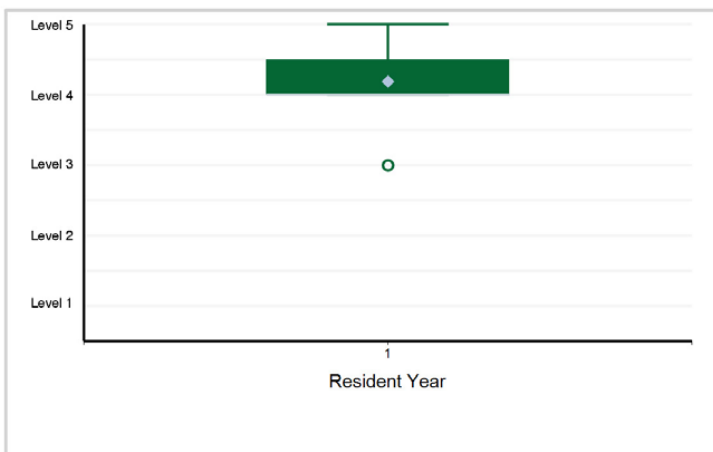

16. Professionalism - Compassion, integrity, and respect for others as well as sensitivity and responsiveness ...

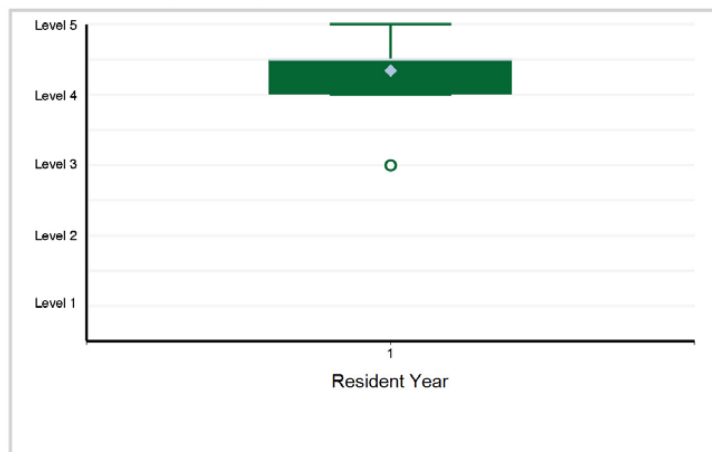

17. Professionalism - Accountability to patients, society, and the profession; personal responsibility to ...

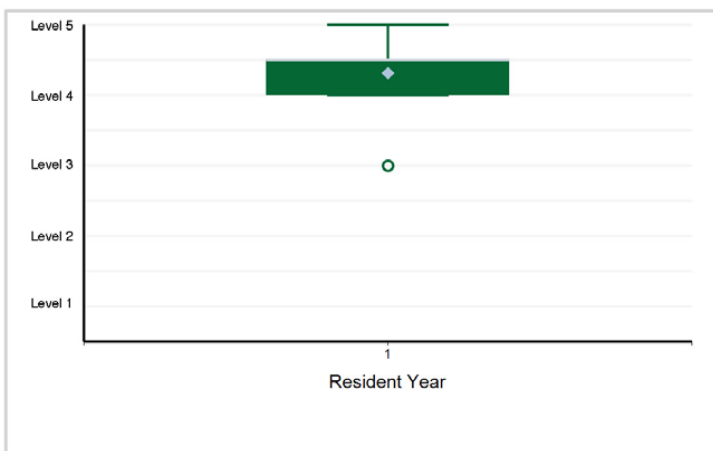

18. Interpersonal and Communication Skills - Communication—Interpersonal and Communication Skills

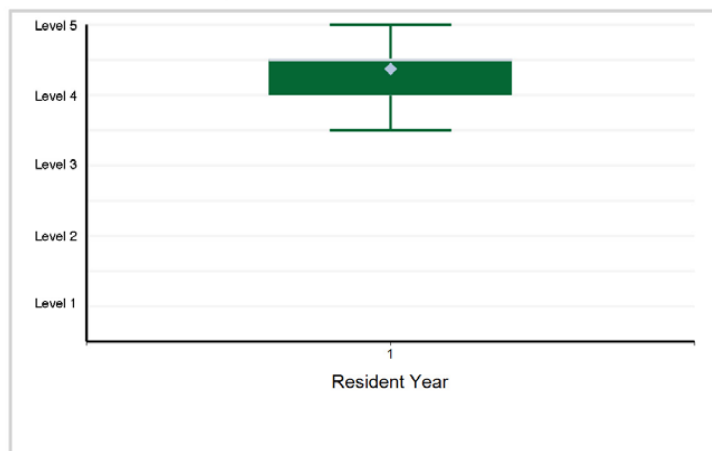

Specialty Box Plot Report - Milestone Evaluation by Resident Year: Year-End 2021-2022

SUBSPECIALTY: **Musculoskeletal Oncology**

19. Interpersonal and Communication Skills - Teamwork—Interpersonal and Communication Skills

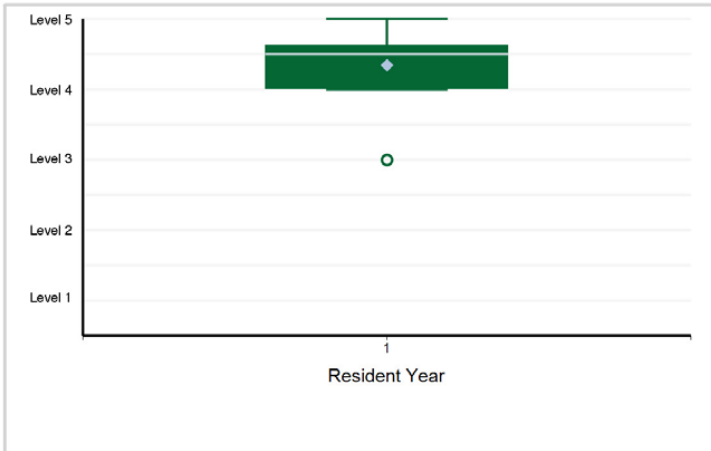

Specialty Box Plot Report - Milestone Evaluation by Resident Year: Year-End 2021-2022

TABLE 74: SUBSPECIALTY: **Orthopaedic Sports Medicine**

Resident Year	1	Total Residents
# of Residents	216	216

1. Patient Care - Nonoperative: history and physical examination, imaging interpretation, common medical ...

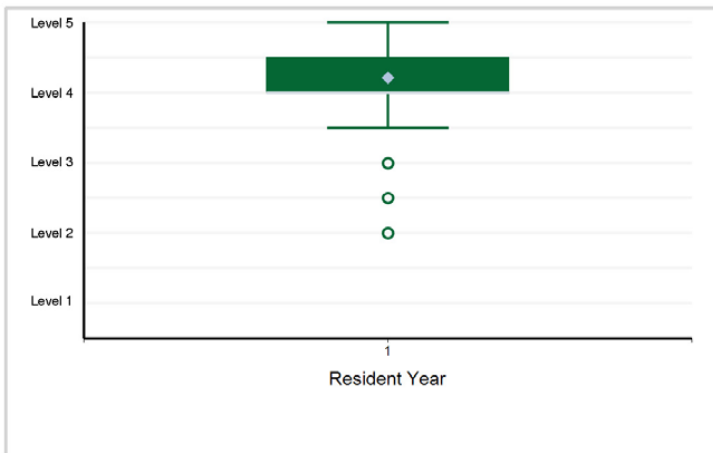

2. Patient Care - Operative Skills—Patient Care

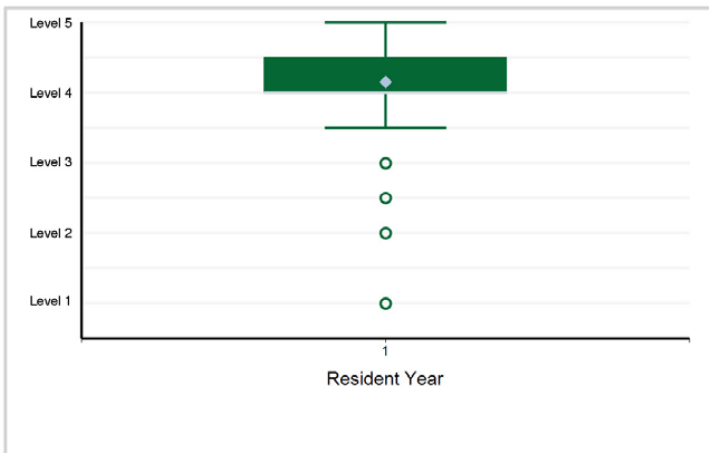

3. Patient Care - Team Coverage and Athletic Care: coverage of sporting events, preseason physical examinations, ...

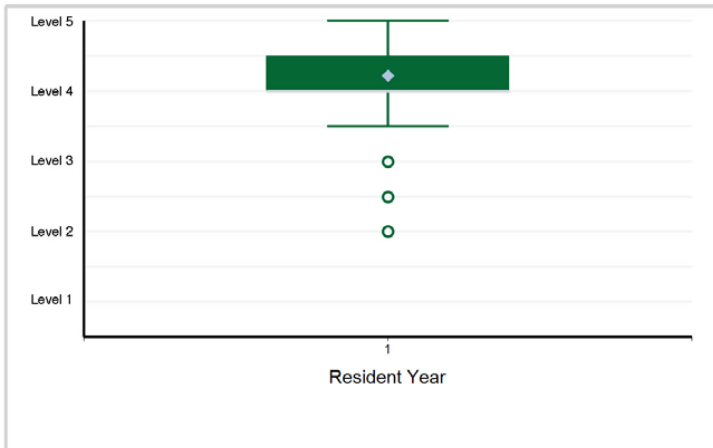

4. Medical Knowledge - Basic Science: gross anatomy, microanatomy, rehabilitation and kinesiology, pathophysiology, tissue ...

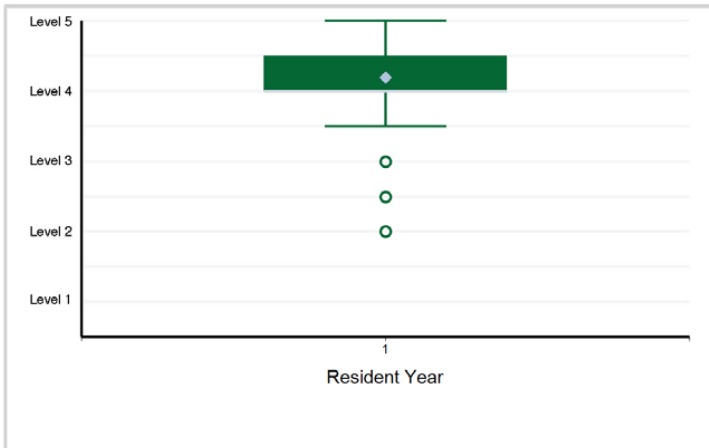

5. Medical Knowledge - Medical Issues: cardiopulmonary, skin, heat/cold intolerance, concussions, gastrointestinal ...

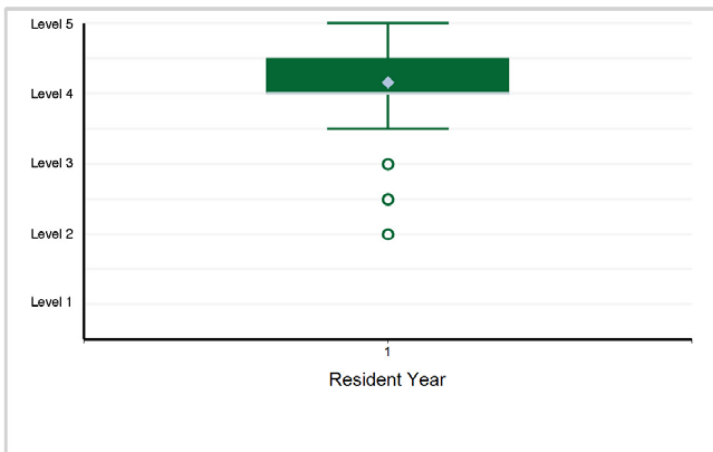

6. Medical Knowledge - Musculoskeletal: acute and chronic orthopaedic disorders, acute non-orthopaedic ...

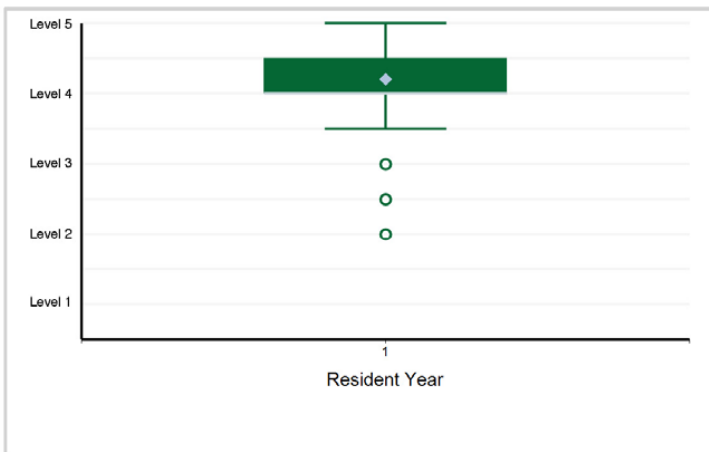

Specialty Box Plot Report - Milestone Evaluation by Resident Year: Year-End 2021-2022

SUBSPECIALTY: Orthopaedic Sports Medicine

7. Systems-Based Practice - Working with interprofessional teams (consultants, certified athletic trainer [ATCs], physical ...

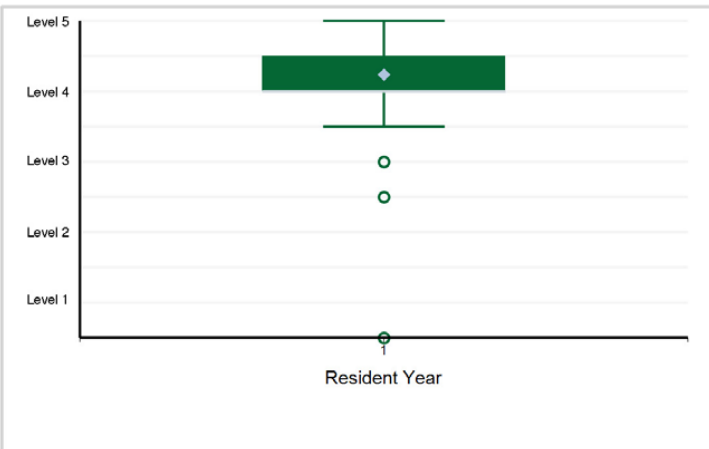

8. Systems-Based Practice - Systems thinking—Systems-based Practice



9. Practice-Based Learning and Improvement - Self-directed learning—Practice-based Learning and Improvement

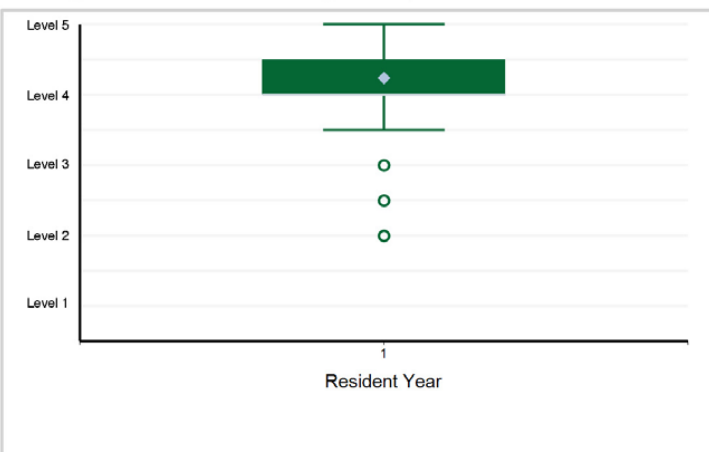

10. Practice-Based Learning and Improvement - Locate, appraise, and contribute to evidence to improve patient ...

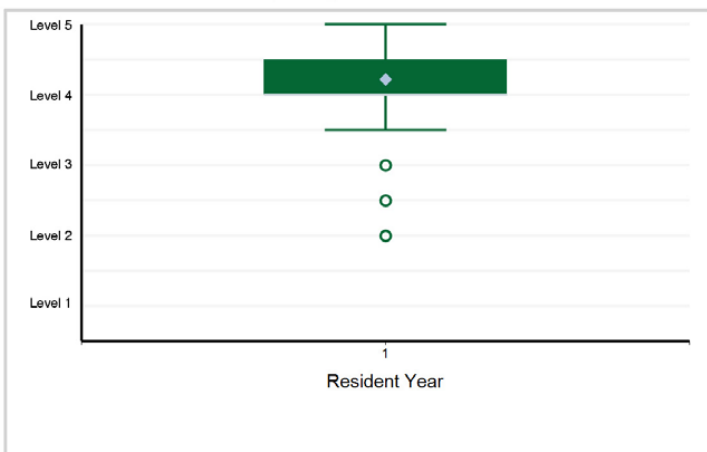

11. Professionalism - Compassion, integrity, respect for others, and sensitivity to the diversity of the athlete—Professionalism

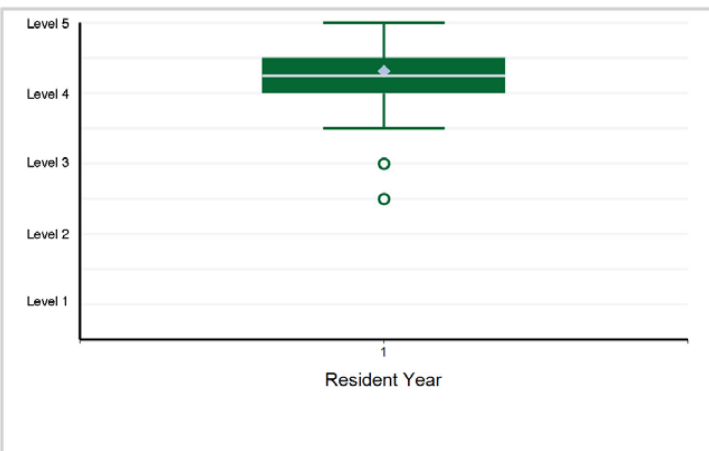

12. Professionalism - Accountability to patients, society, and the profession; personal responsibility to ...

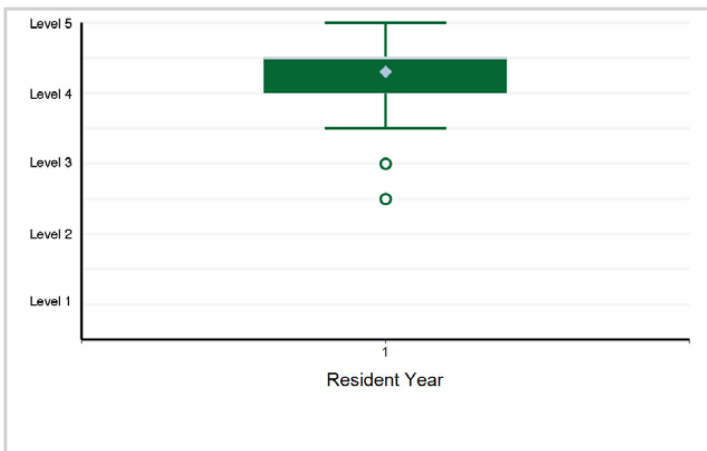

Specialty Box Plot Report - Milestone Evaluation by Resident Year: Year-End 2021-2022

SUBSPECIALTY: Orthopaedic Sports Medicine

13. Interpersonal and Communication Skills - Communication—Interpersonal and Communication Skills



14. Interpersonal and Communication Skills - Teamwork—Interpersonal and Communication Skills

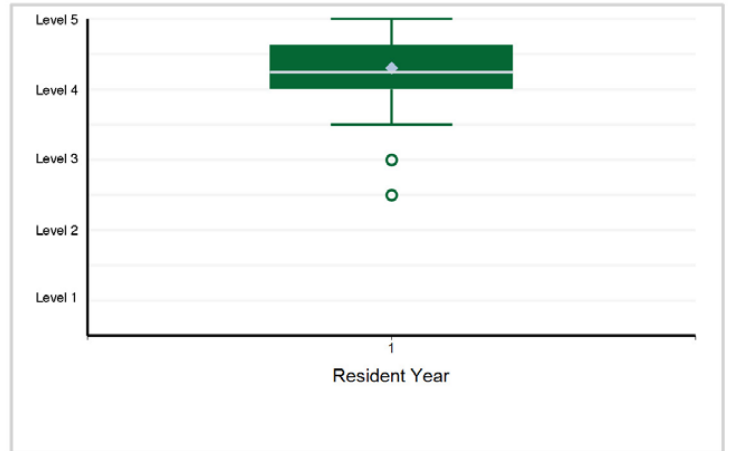

Specialty Box Plot Report - Milestone Evaluation by Resident Year: Year-End 2021-2022

TABLE 75: SUBSPECIALTY: **Orthopaedic Surgery of the Spine**

Resident Year	1	Total Residents
# of Residents	25	25

1. Patient Care - Degenerative Lumbar—Patient Care

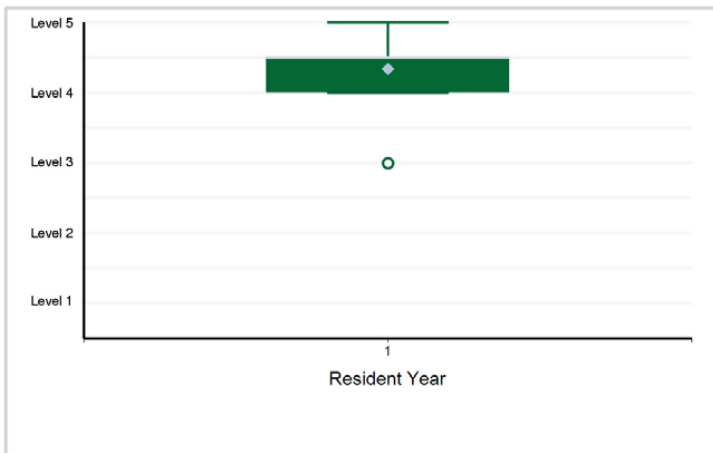

2. Patient Care - Degenerative Cervical—Patient Care

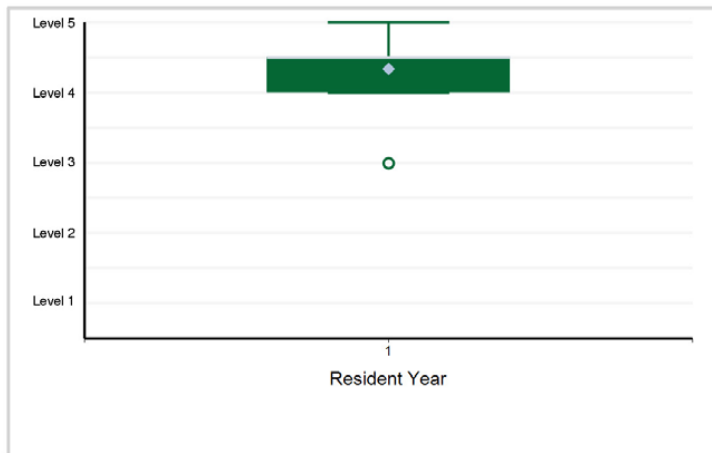

3. Patient Care - Traumatic—Patient Care

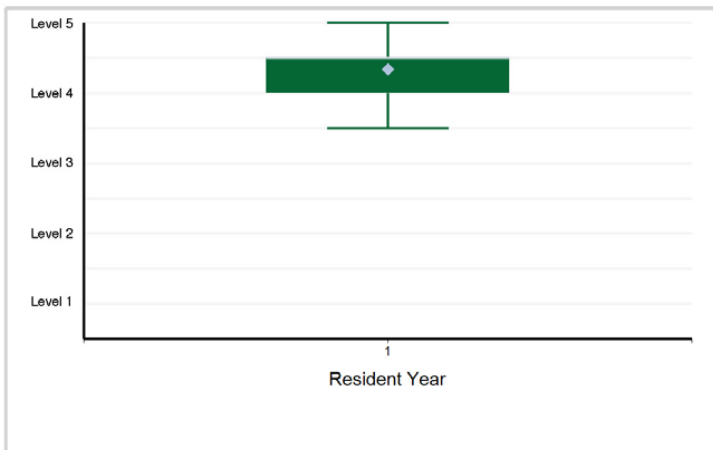

4. Patient Care - Deformity—Patient Care

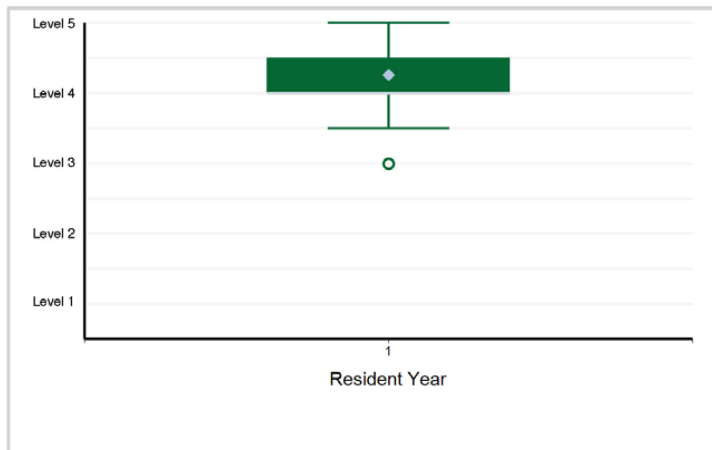

5. Medical Knowledge - Degenerative Lumbar—Medical Knowledge

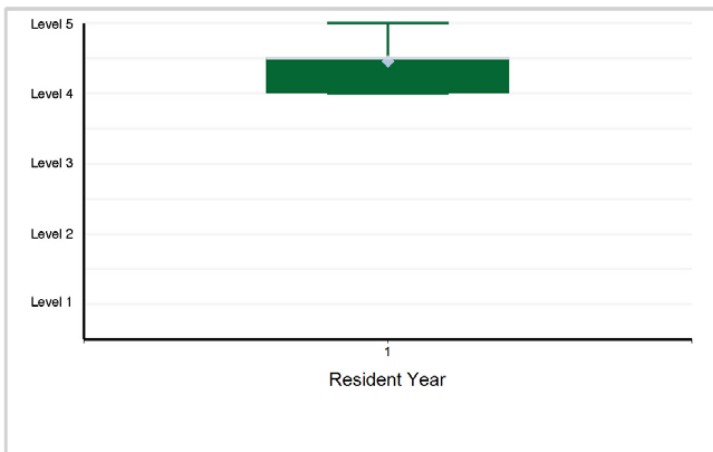

6. Medical Knowledge - Degenerative Cervical—Medical Knowledge

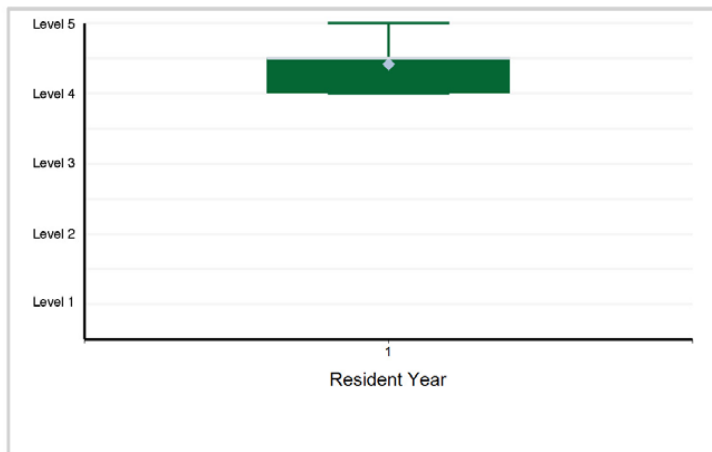

Specialty Box Plot Report - Milestone Evaluation by Resident Year: Year-End 2021-2022

SUBSPECIALTY: Orthopaedic Surgery of the Spine

7. Medical Knowledge - Traumatic—Medical Knowledge

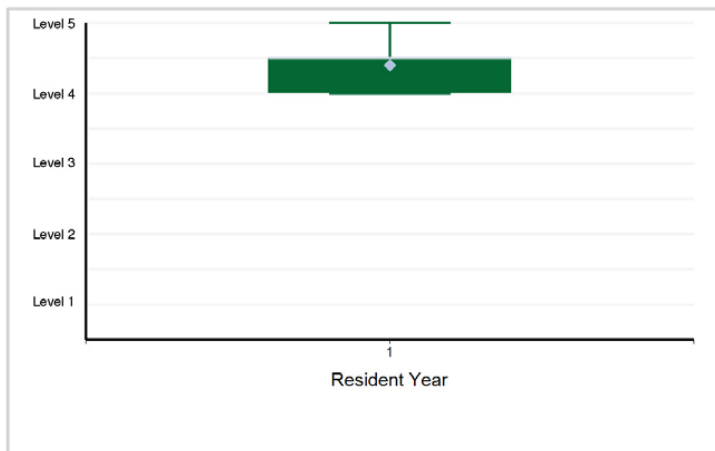

8. Medical Knowledge - Deformity—Medical Knowledge

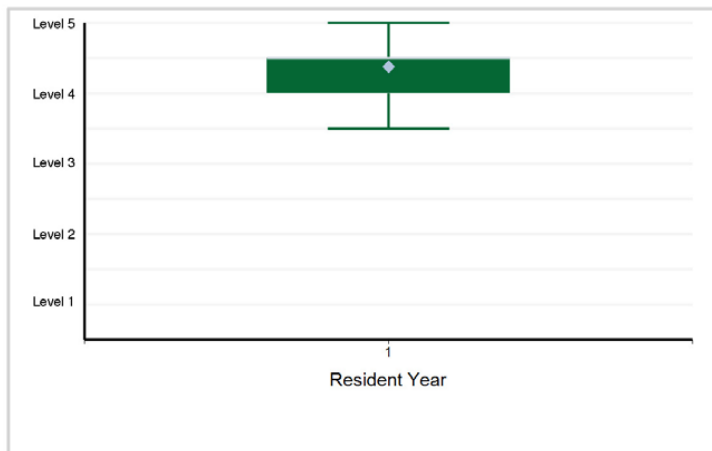

9. Systems-Based Practice - Systems-based Practice

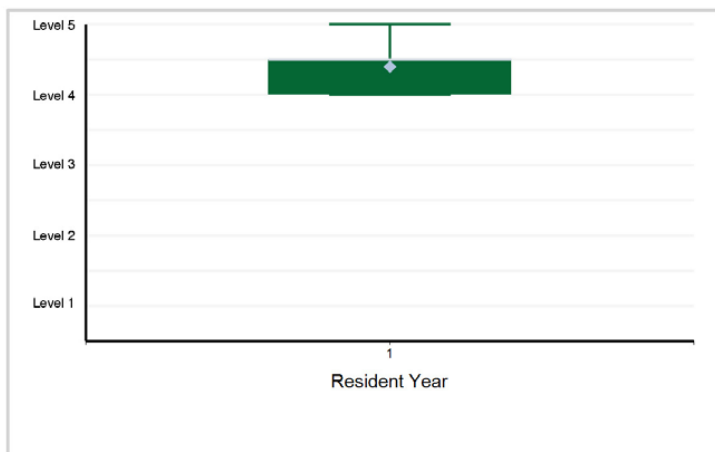

10. Practice-Based Learning and Improvement - Self-directed Learning—Practice-based Learning and Improvement

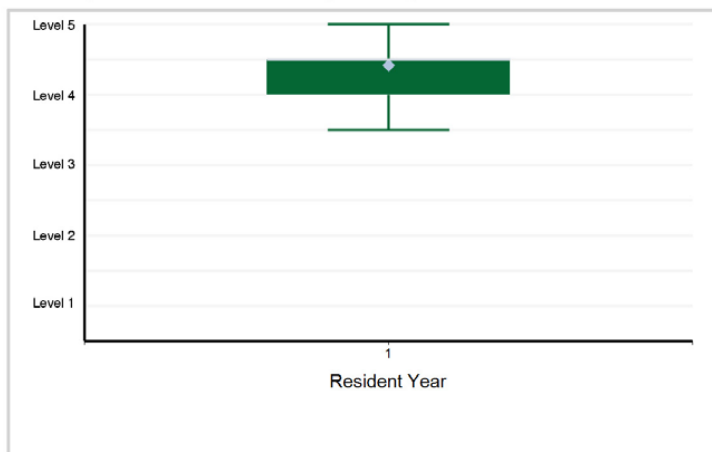

11. Practice-Based Learning and Improvement - Evidence-based Medicine—Practice-based Learning and Improvement

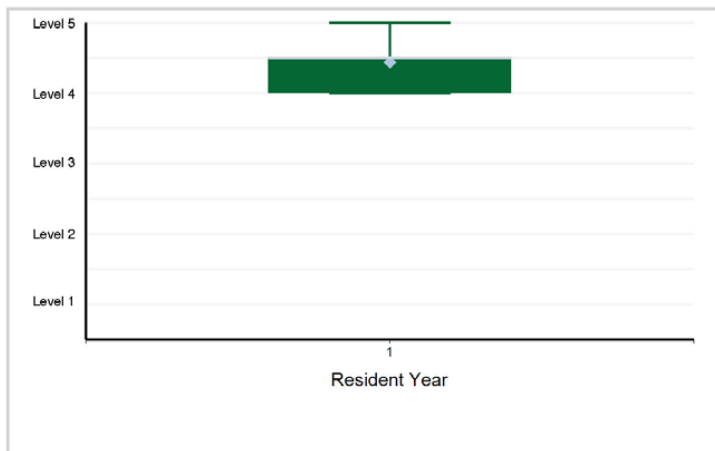

12. Professionalism - Commitment to diversity, compassion, integrity, sensitivity, and ethics—Professionalism

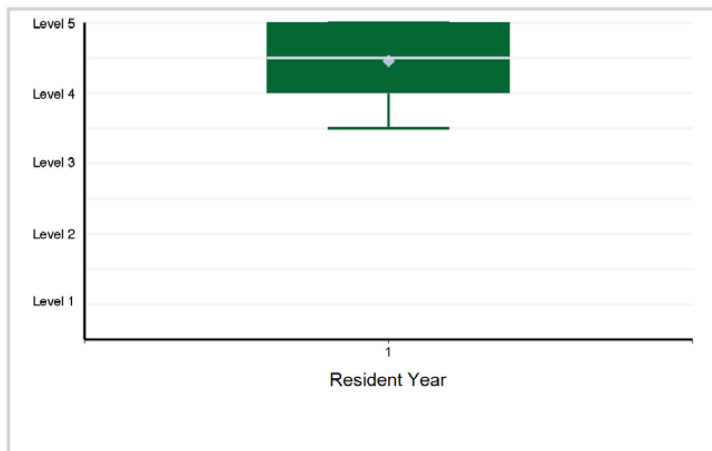

Specialty Box Plot Report - Milestone Evaluation by Resident Year: Year-End 2021-2022

SUBSPECIALTY: Orthopaedic Surgery of the Spine

13. Professionalism - Accountability and professionalism—Professionalism

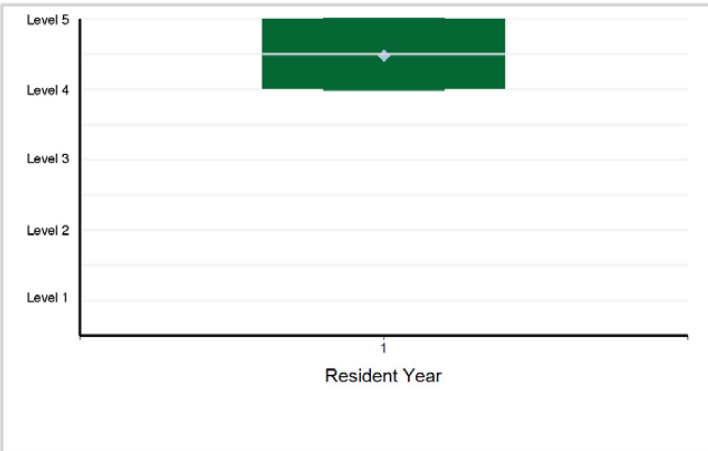

14. Interpersonal and Communication Skills - Patient Centered Communications—Interpersonal and Communication Skills

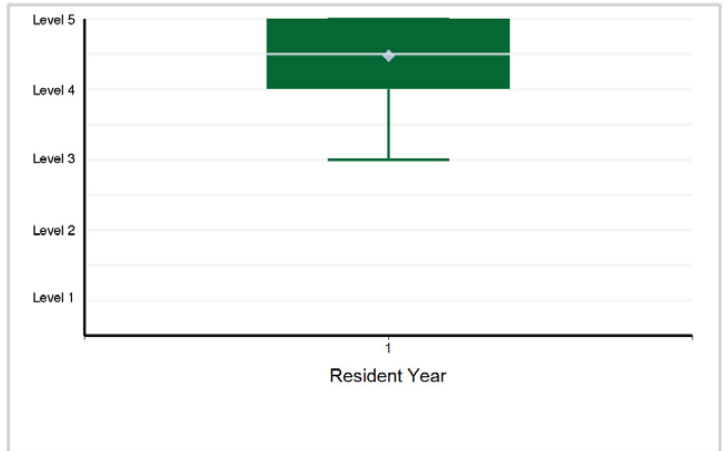

15. Interpersonal and Communication Skills - Interpersonal and Communication Skills

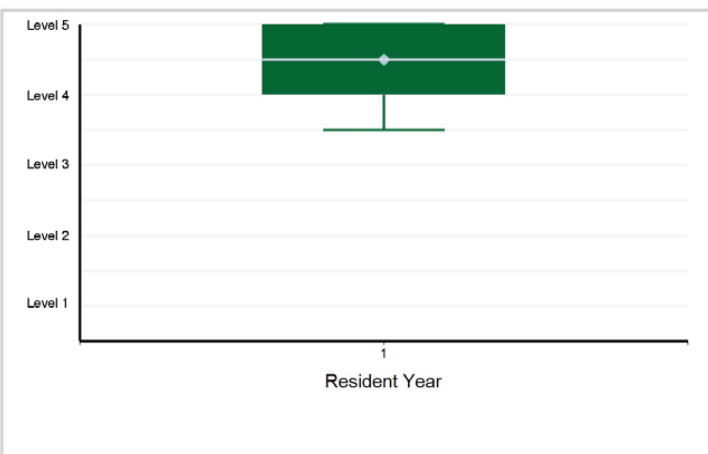

Specialty Box Plot Report - Milestone Evaluation by Resident Year: Year-End 2021-2022

TABLE 76: SUBSPECIALTY: **Orthopaedic Trauma**

Resident Year	1	Total Residents
# of Residents	20	20

1. Patient Care - Care of multiply injured patient—Patient Care

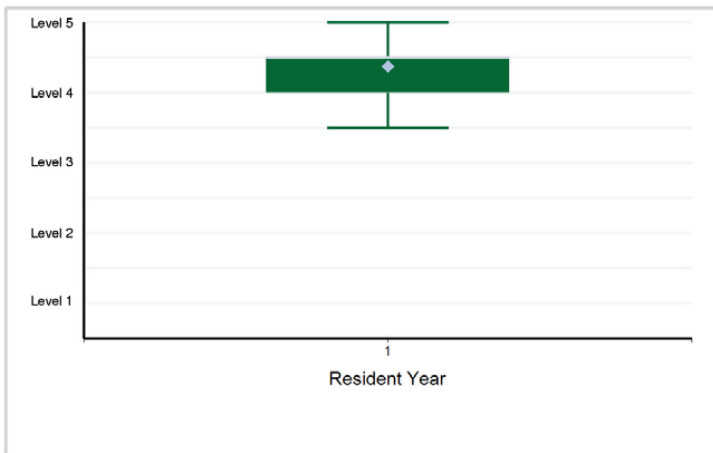

2. Medical Knowledge - Care of multiply injured patient—Medical Knowledge

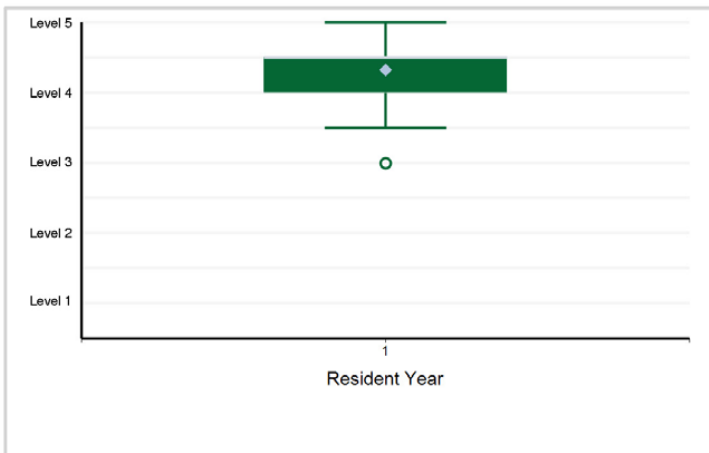

3. Patient Care - Complex Diaphyseal Fracture—Patient Care



4. Medical Knowledge - Complex Diaphyseal Fracture—Medical Knowledge

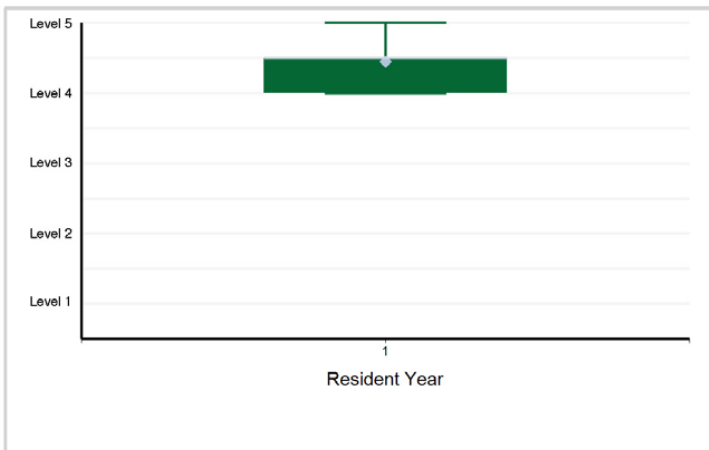

5. Patient Care - Complex Periarticular Fractures—Patient Care

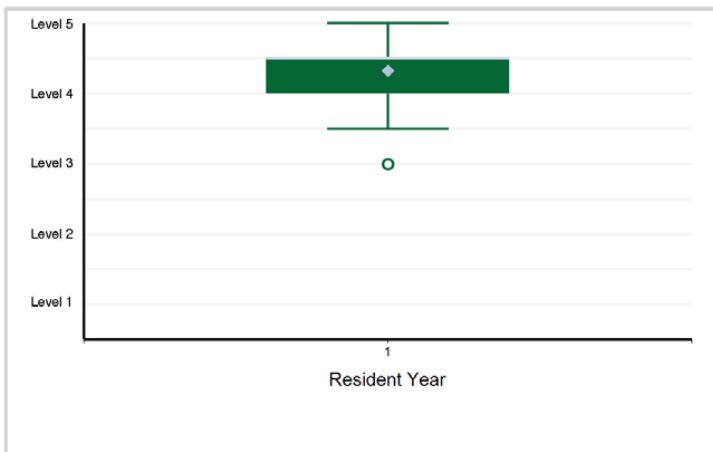

6. Medical Knowledge - Complex Periarticular Fractures—Medical Knowledge

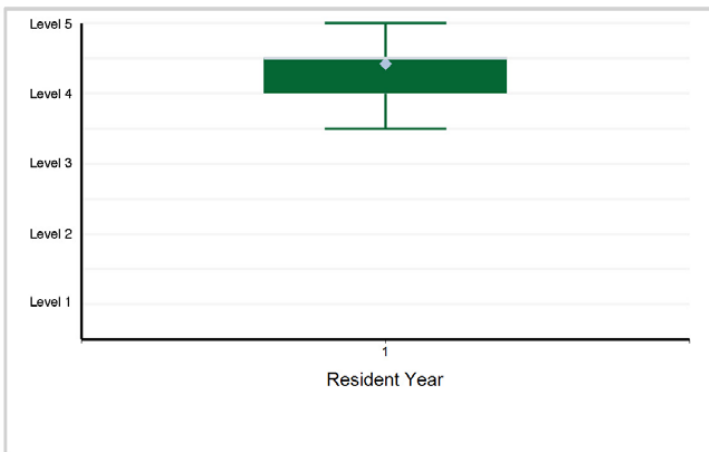

Specialty Box Plot Report - Milestone Evaluation by Resident Year: Year-End 2021-2022

SUBSPECIALTY: Orthopaedic Trauma

7. Patient Care - Nonunion/Malunion—Patient Care

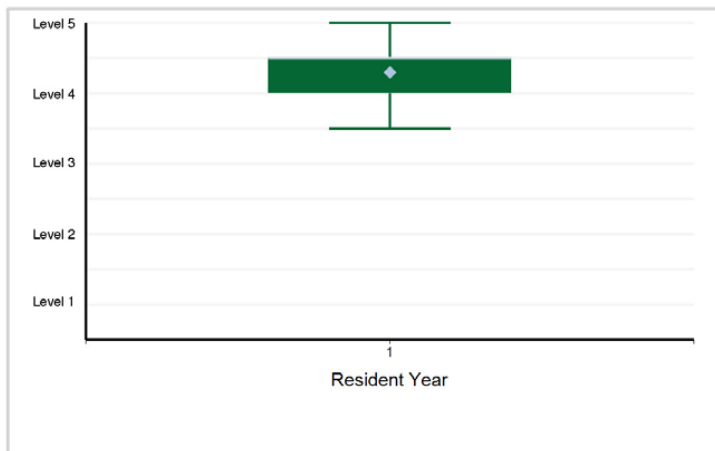

8. Medical Knowledge - Nonunion/Malunion—Medical Knowledge

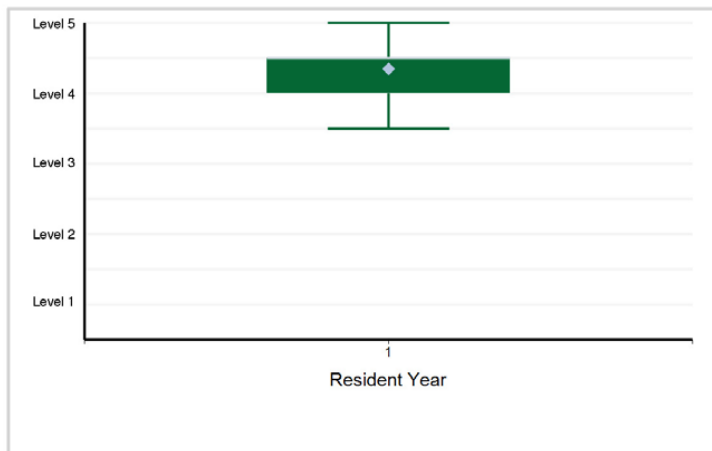

9. Patient Care - Pelvic and Acetabular fractures—Patient Care

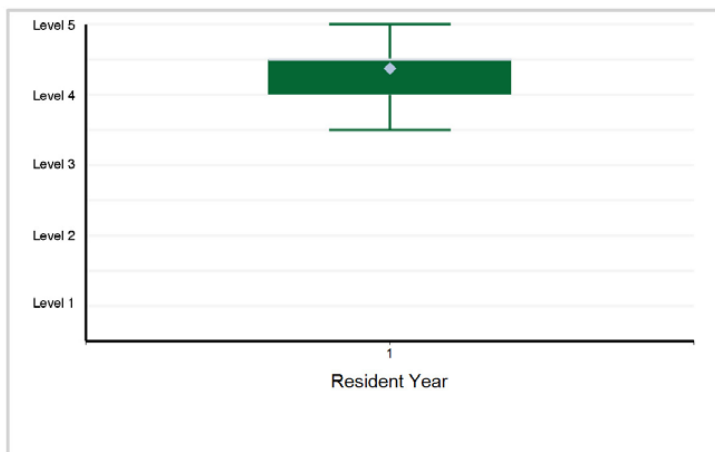

10. Medical Knowledge - Pelvic and Acetabular fractures—Medical Knowledge

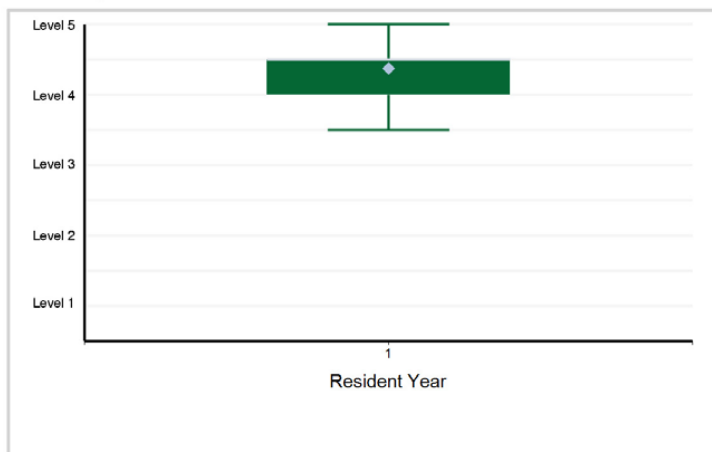

11. Systems-Based Practice - Systems thinking, including cost-effective practice—Systems-Based Practice

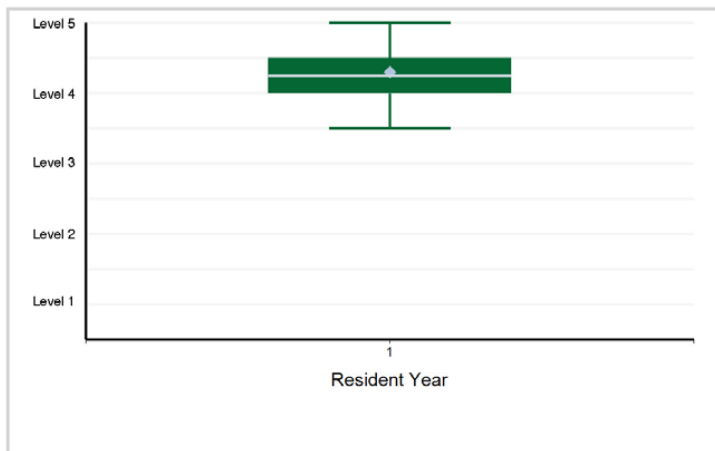

12. Systems-Based Practice - Fellow will work in interprofessional teams to enhance patient safety, quality ...

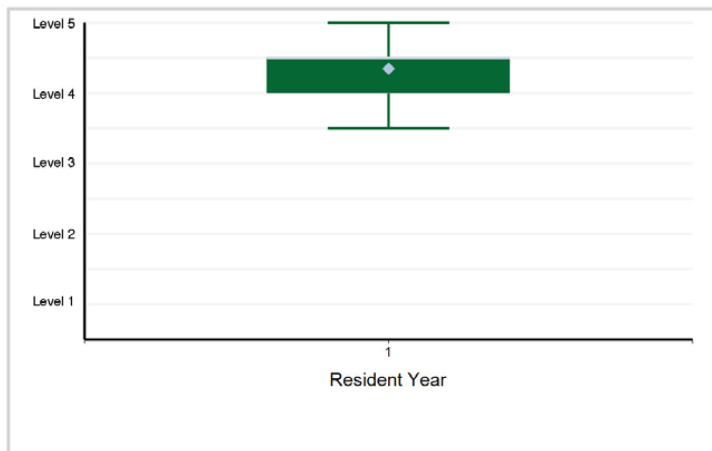

Specialty Box Plot Report - Milestone Evaluation by Resident Year: Year-End 2021-2022

SUBSPECIALTY: Orthopaedic Trauma

13. Practice-Based Learning and Improvement - Self-directed Learning—Practice-Based Learning and Improvement ...

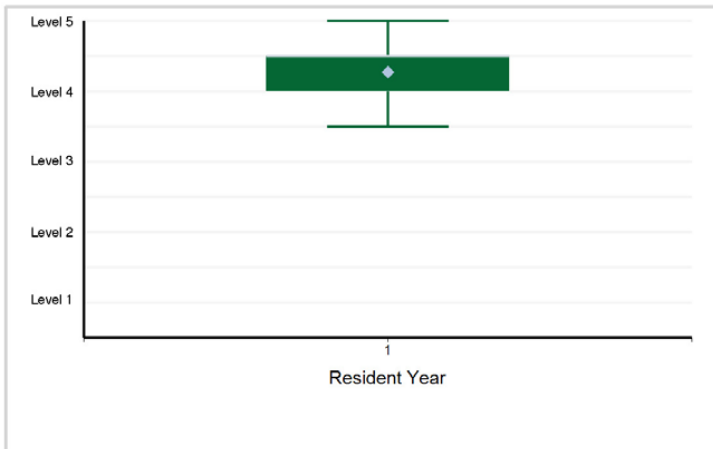

14. Practice-Based Learning and Improvement - Locate, appraise, and assimilate evidence from scientific ...

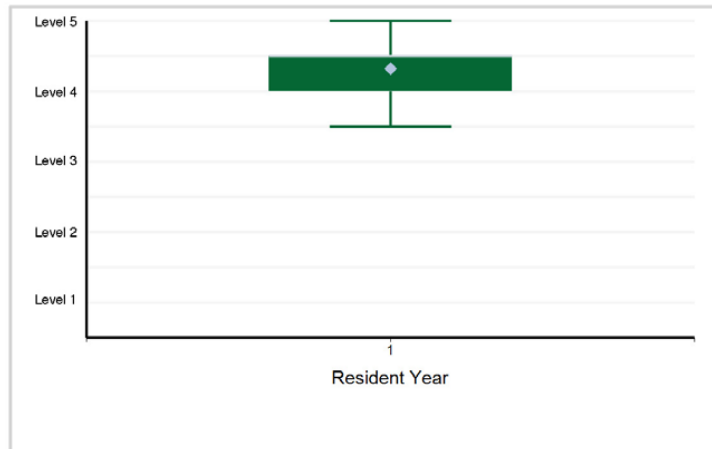

15. Professionalism - Compassion, integrity, and respect for others, as well as sensitivity and responsiveness ...

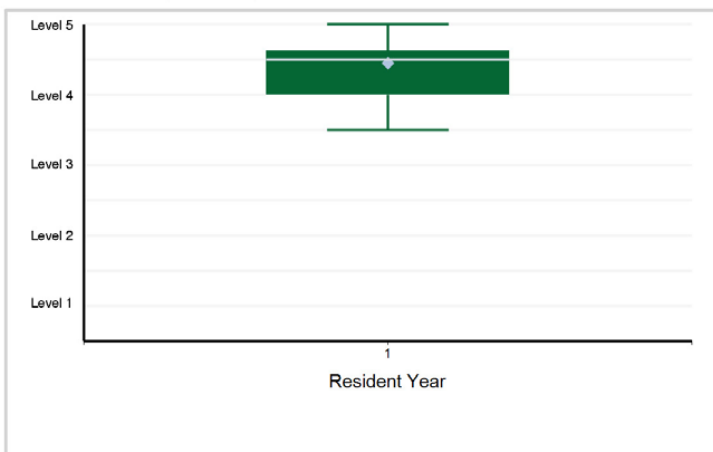

16. Professionalism - Accountability to patients, society, and the profession; personal responsibility to ...

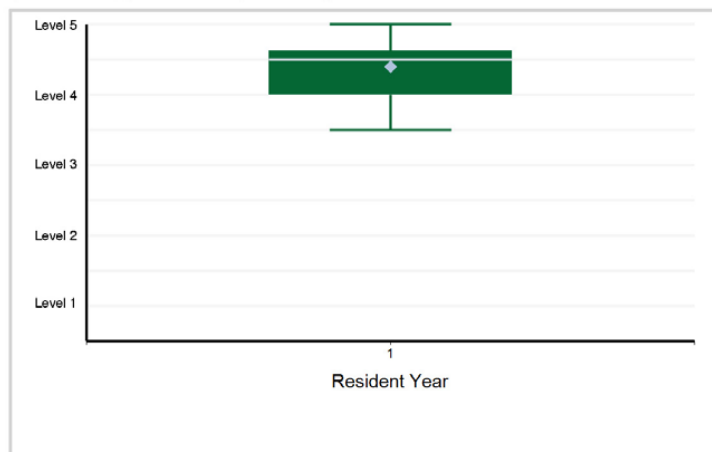

17. Interpersonal and Communication Skills - Communication—Interpersonal and Communication Skills

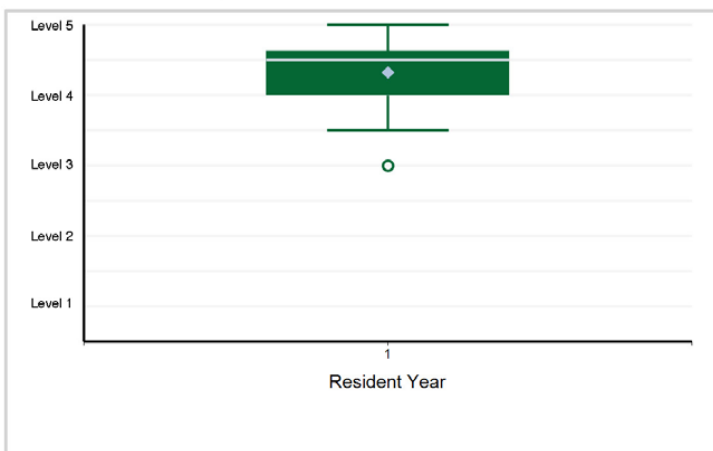

18. Interpersonal and Communication Skills - Teamwork (e.g., physician, nursing and allied health care providers, ...)

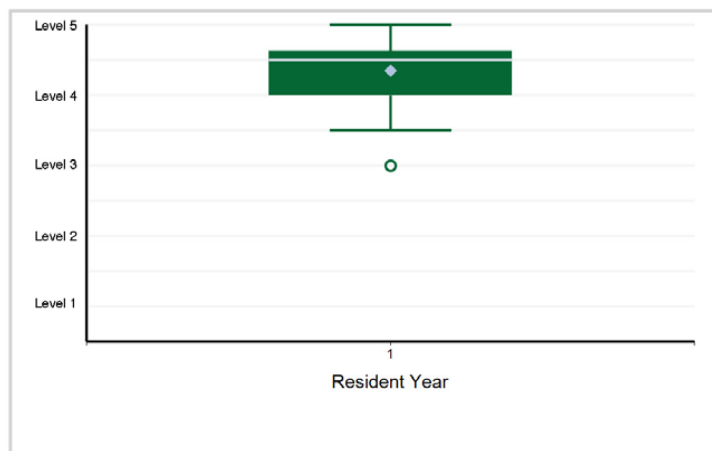

Specialty Box Plot Report - Milestone Evaluation by Resident Year: Year-End 2021-2022

TABLE 77: SUBSPECIALTY: **Pediatric Orthopaedic Surgery**

Resident Year	1	Total Residents
# of Residents	35	35

1. Patient Care - Pediatric Orthopaedics Idiopathic Scoliosis—Patient Care

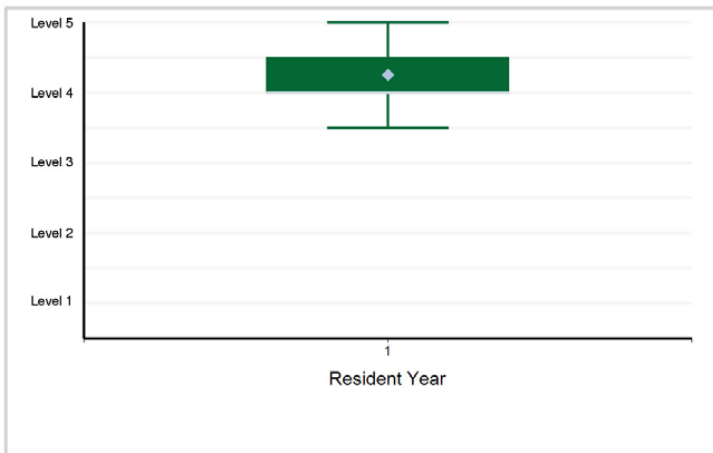

2. Medical Knowledge - Pediatric Orthopaedics Idiopathic Scoliosis—Medical Knowledge

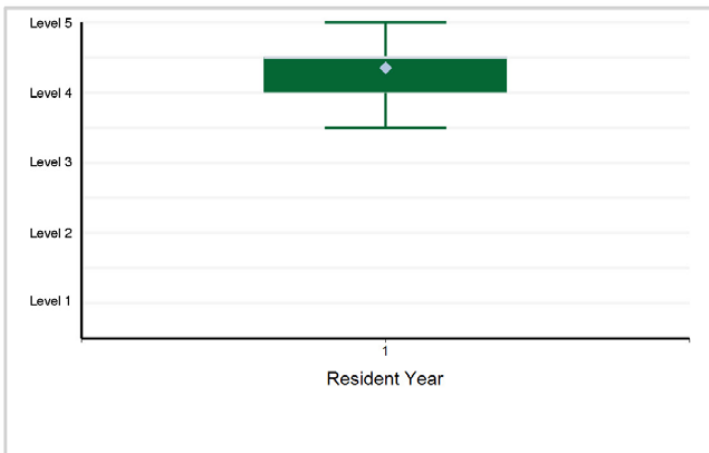

3. Patient Care - Pediatric Orthopaedics developmental dysplasia of hip [DDH] prior to walking age—Patient Care

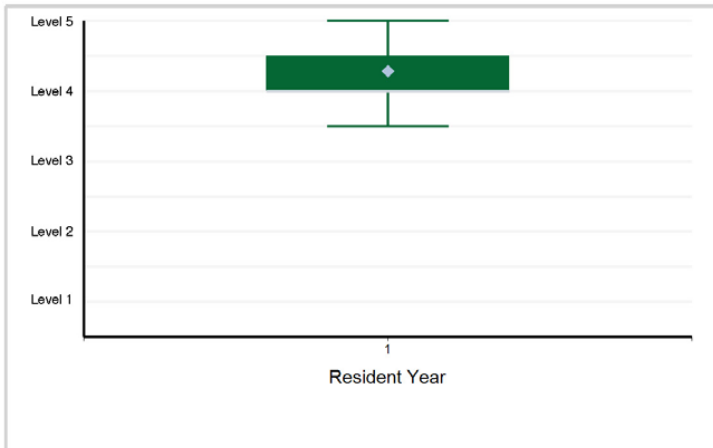

4. Medical Knowledge - Pediatric Orthopaedics developmental dysplasia of hip [DDH] prior to walking age—Medical Knowledge

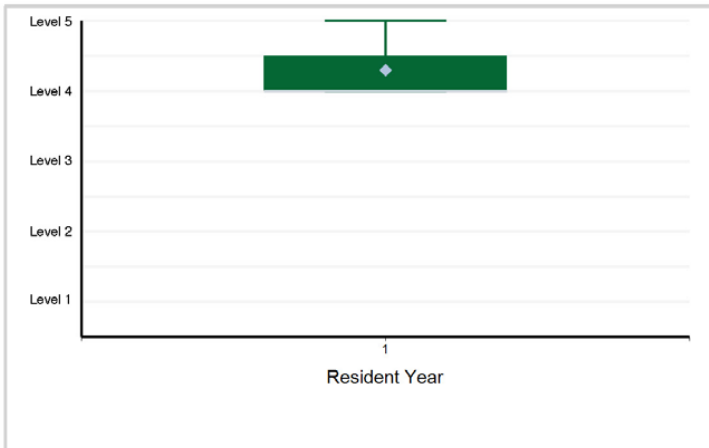

5. Patient Care - Pediatric Orthopaedics slipped capital femoral epiphysis [SCFE]—Patient Care

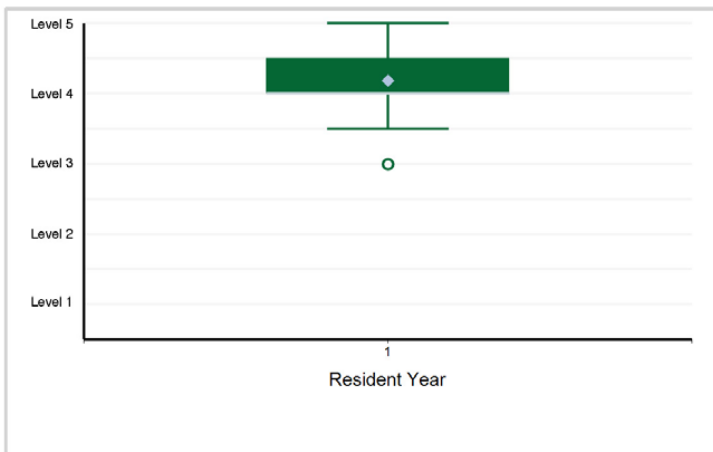

6. Medical Knowledge - Pediatric Orthopaedics slipped capital femoral epiphysis [SCFE]—Medical Knowledge

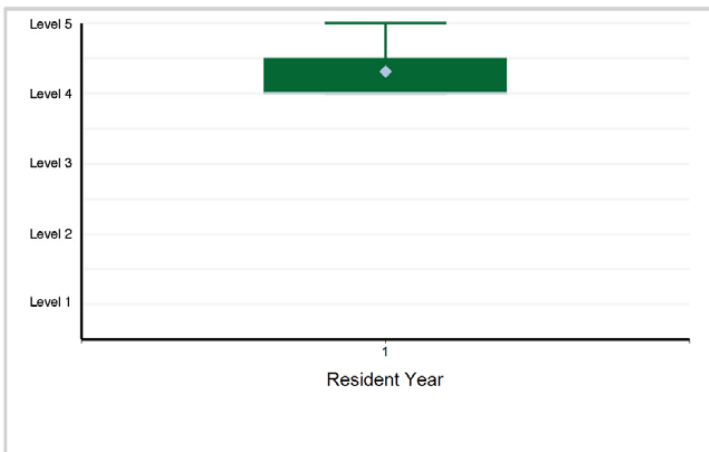

Specialty Box Plot Report - Milestone Evaluation by Resident Year: Year-End 2021-2022

SUBSPECIALTY: Pediatric Orthopaedic Surgery

7. Patient Care - Pediatric Orthopaedics Clubfoot—Patient Care

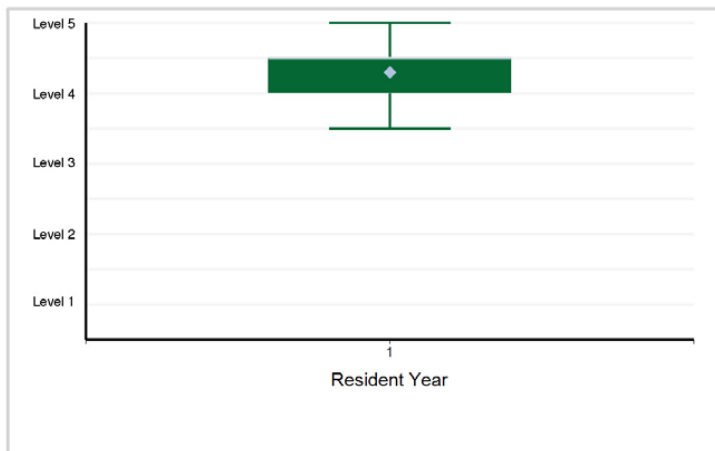

8. Medical Knowledge - Pediatric Orthopaedics Clubfoot—Medical Knowledge

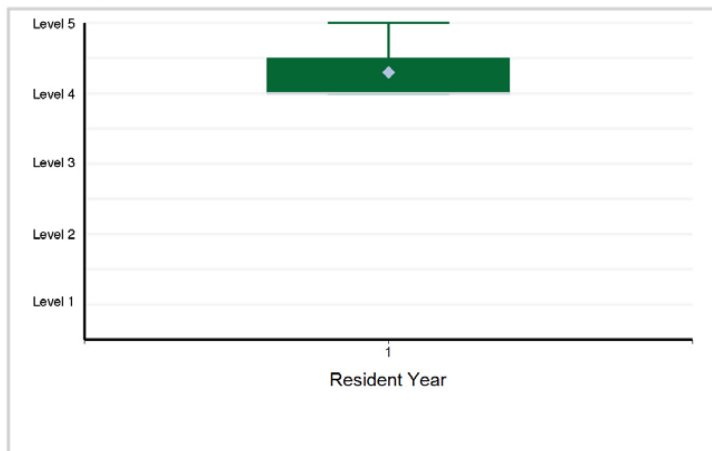

9. Patient Care - Pediatric Orthopaedics Lower Extremity Deformity—Patient Care

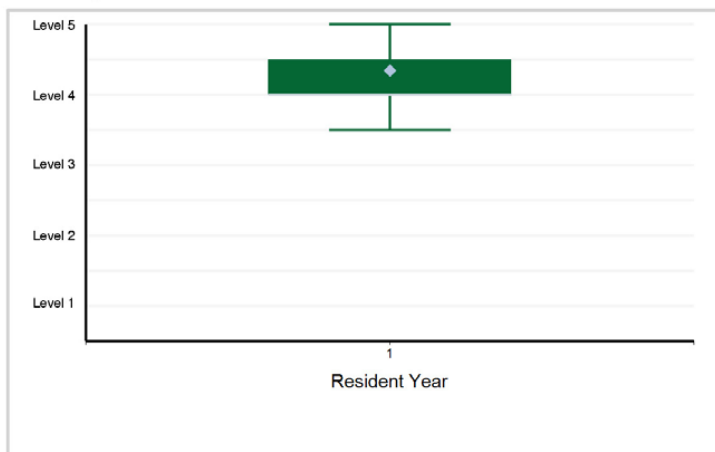

10. Medical Knowledge - Pediatric Orthopaedics Lower Extremity Deformity—Medical Knowledge

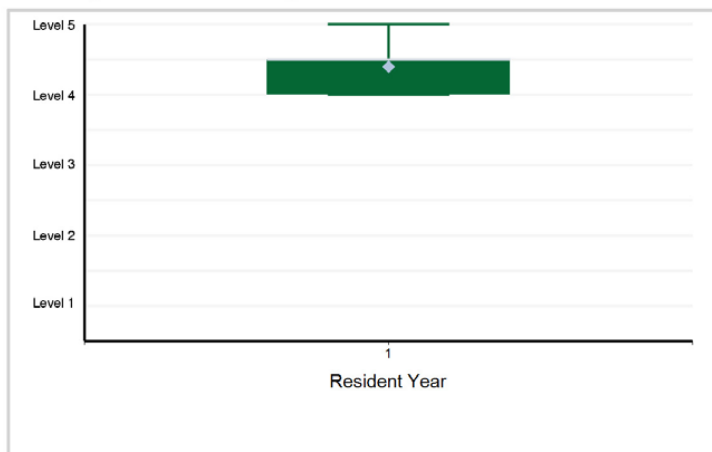

11. Patient Care - Pediatric Orthopaedics Cerebral Palsy [CP]—Patient Care

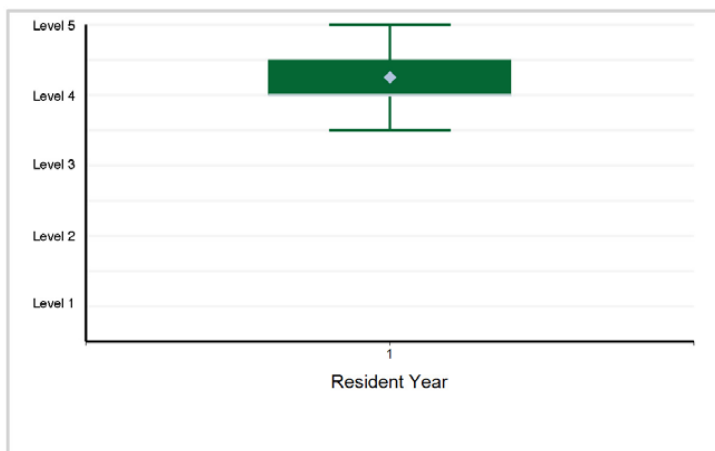

12. Medical Knowledge - Pediatric Orthopaedics Cerebral Palsy [CP]—Medical Knowledge

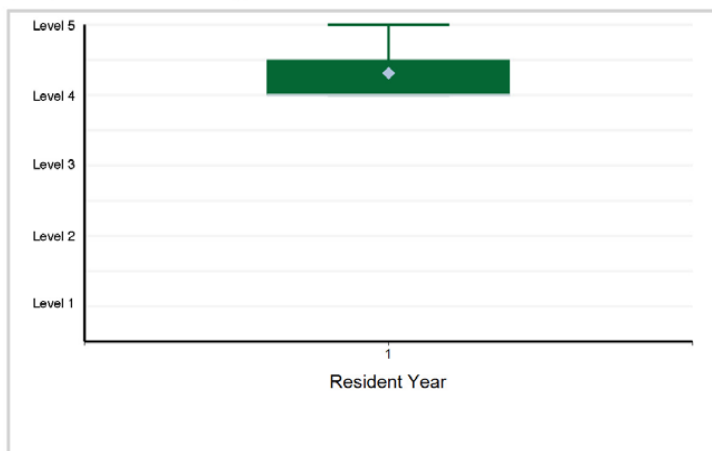

Specialty Box Plot Report - Milestone Evaluation by Resident Year: Year-End 2021-2022

SUBSPECIALTY: Pediatric Orthopaedic Surgery

13. Systems-Based Practice - Systems thinking, including cost-effective practice—Systems-Based Practice

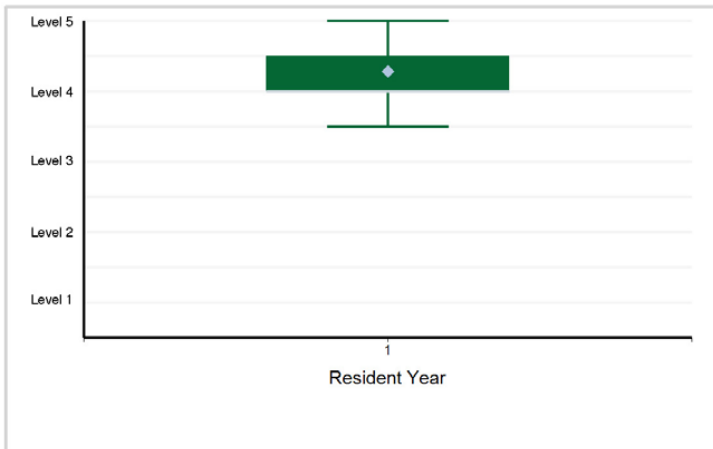

14. Systems-Based Practice - Resident will work in interprofessional teams to enhance patient safety and ...

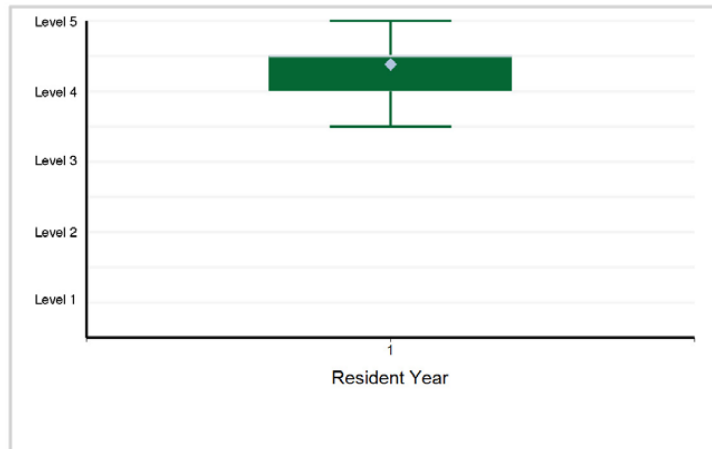

15. Systems-Based Practice - Uses technology to accomplish safe health care delivery—Systems-Based Practice

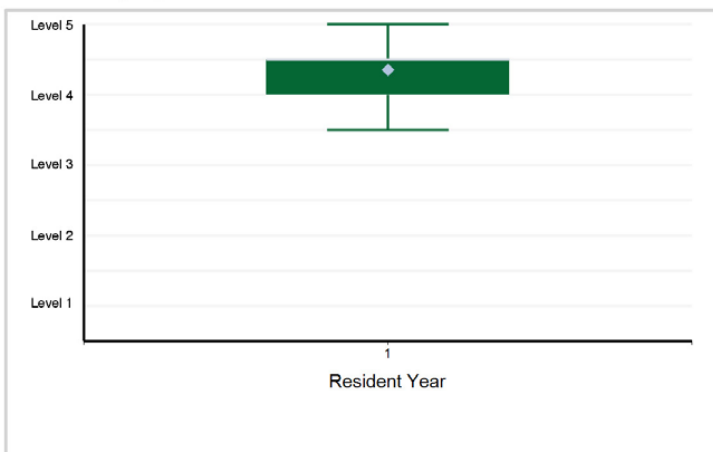

16. Practice-Based Learning and Improvement - Self-Directed Learning—Practice-Based Learning and Improvement 1. Identifies ...

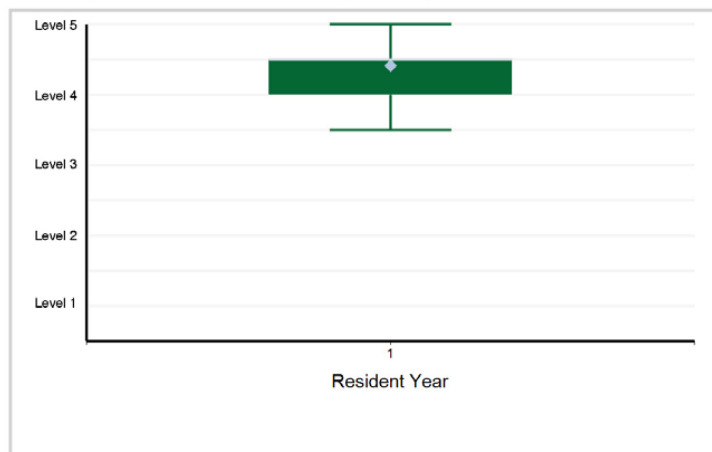

17. Practice-Based Learning and Improvement - Locates, appraises, and assimilates evidence from scientific ...

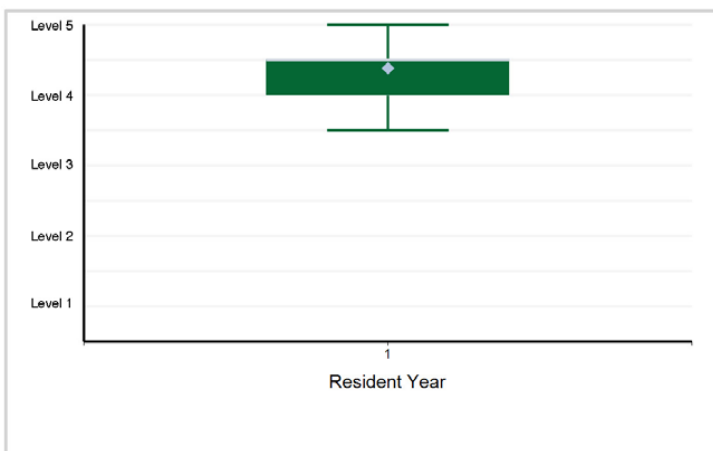

18. Professionalism - Demonstrates compassion, integrity, and respect for others, as well as sensitivity and responsiveness ...

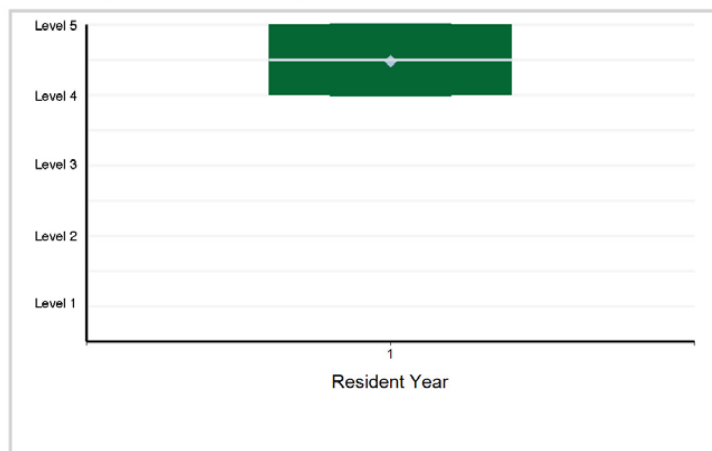

Specialty Box Plot Report - Milestone Evaluation by Resident Year: Year-End 2021-2022

SUBSPECIALTY: Pediatric Orthopaedic Surgery

19. Professionalism - Demonstrates accountability to patients, society, and the profession; demonstrates ...

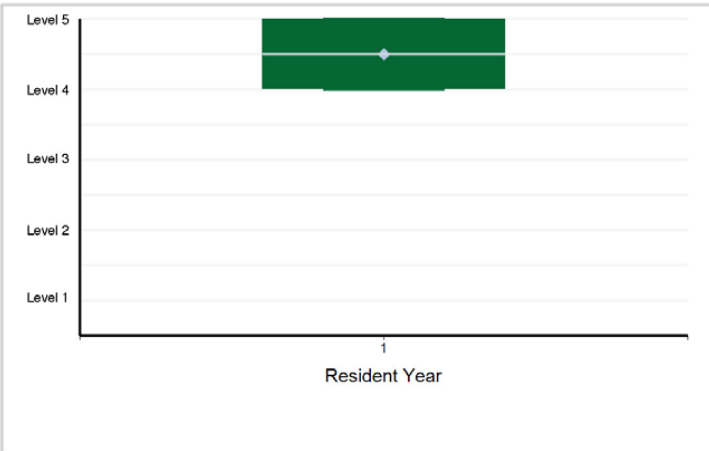

20. Interpersonal and Communication Skills - Communication—Interpersonal and Communication Skills

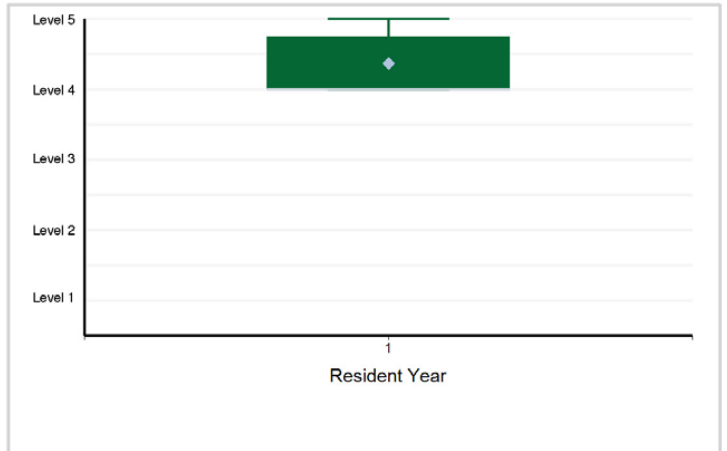

21. Interpersonal and Communication Skills - Teamwork (e.g., physician, nursing and allied health care providers, ...)

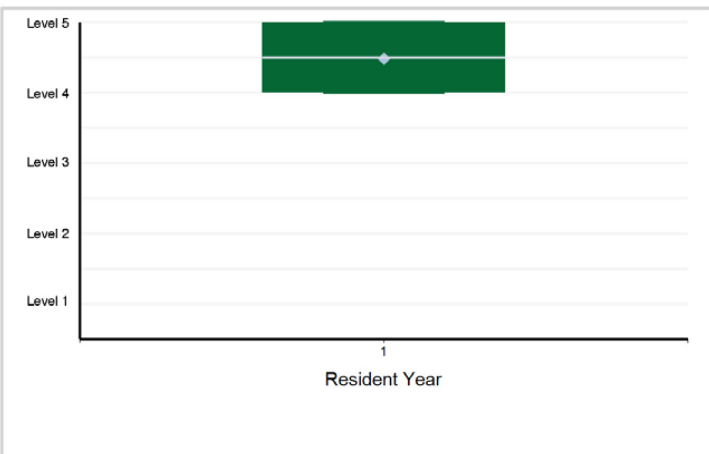

Specialty Box Plot Report - Milestone Evaluation by Resident Year: Year-End 2021-2022

TABLE 78: SPECIALTY: **Osteopathic Neuromusculoskeletal Medicine**

Resident Year	1	2	3	Total Residents
# of Residents	16	22	45	83

1. Patient Care - Patient Care 1: Osteopathic Manipulative Techniques (OMT) (Direct and Indirect)

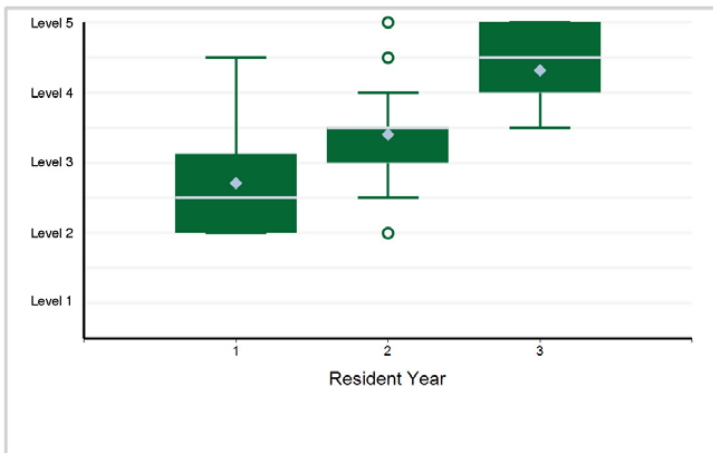

2. Patient Care - Patient Care 2: Trigger Point Injection, Joint Aspiration, and Injection

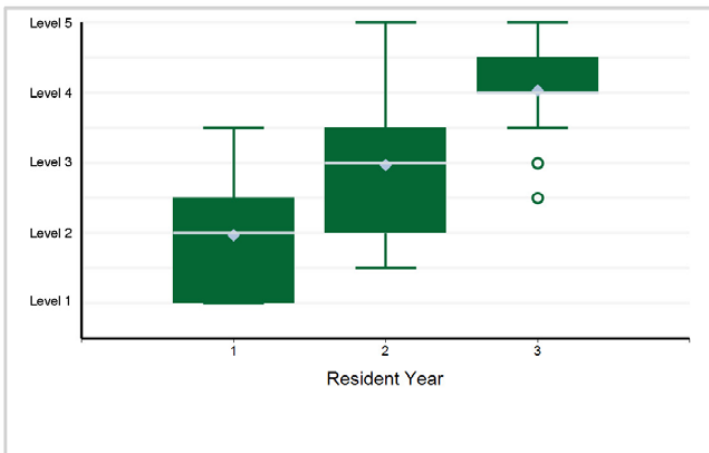

3. Patient Care - Patient Care 3: Patient Management

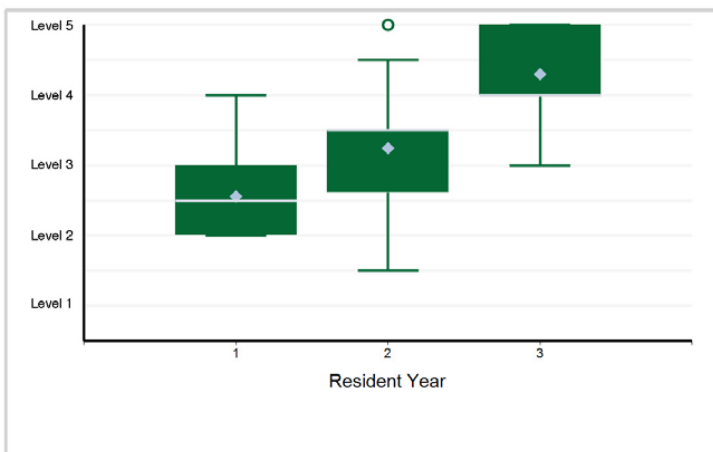

4. Patient Care - Patient Care 4: Providing and Requesting Consultation

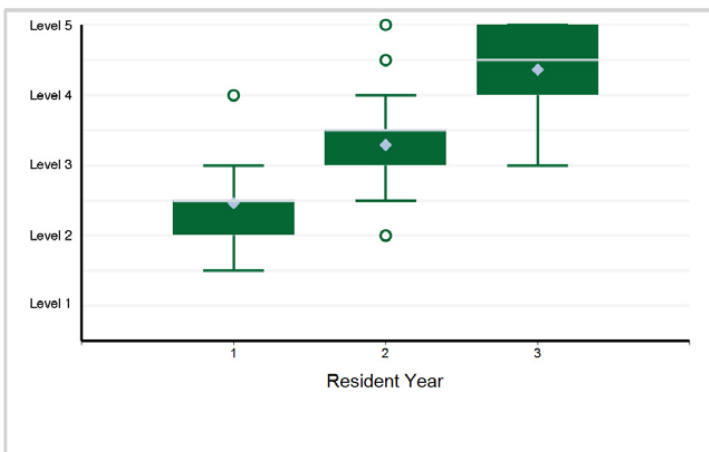

5. Medical Knowledge - Medical Knowledge 1: Possesses Clinical Knowledge (Anatomy, Physiology, Pharmacology, ...)

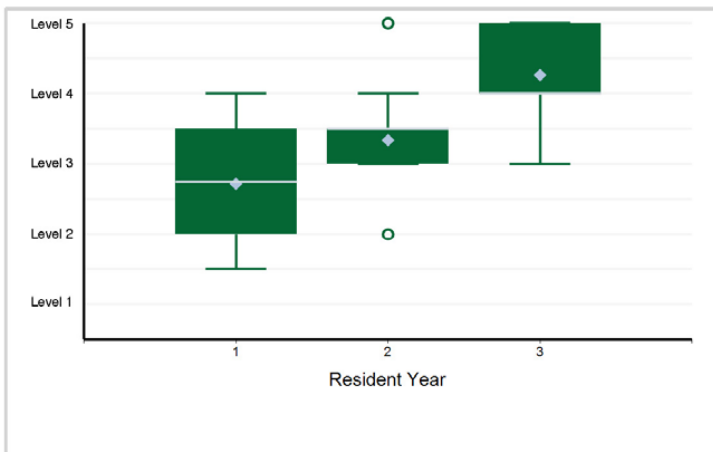

6. Medical Knowledge - Medical Knowledge 2: Manifestation of systemic disease through neuromusculoskeletal ...

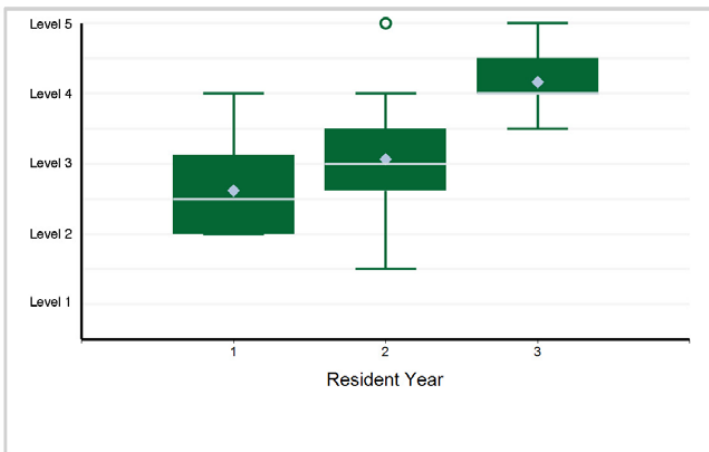

Specialty Box Plot Report - Milestone Evaluation by Resident Year: Year-End 2021-2022

SPECIALTY: Osteopathic Neuromusculoskeletal Medicine

7. Systems-Based Practice - Systems-Based Practice 1: Patient Safety and Advocacy

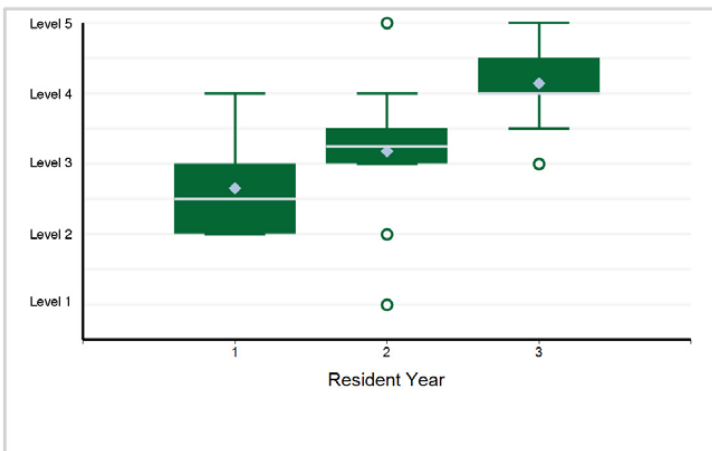

8. Systems-Based Practice - Systems-Based Practice 2: Practice Management and Economics

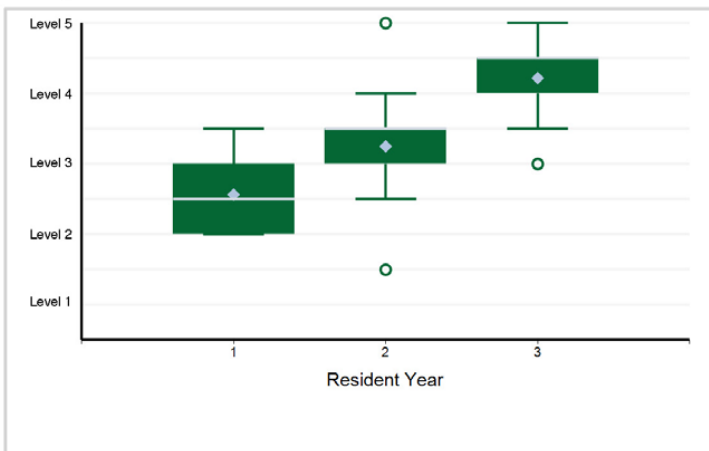

9. Practice-Based Learning and Improvement - Practice-based Learning and Improvement 1: Learning and Feedback

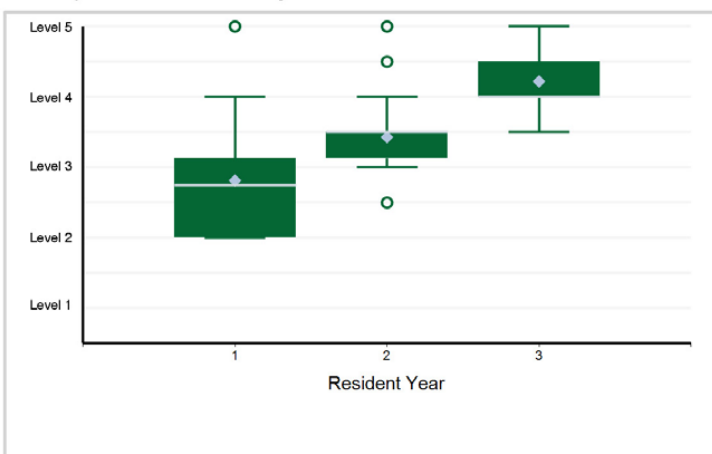

10. Practice-Based Learning and Improvement - Practice-based Learning and Improvement 2: Literature Review and Research

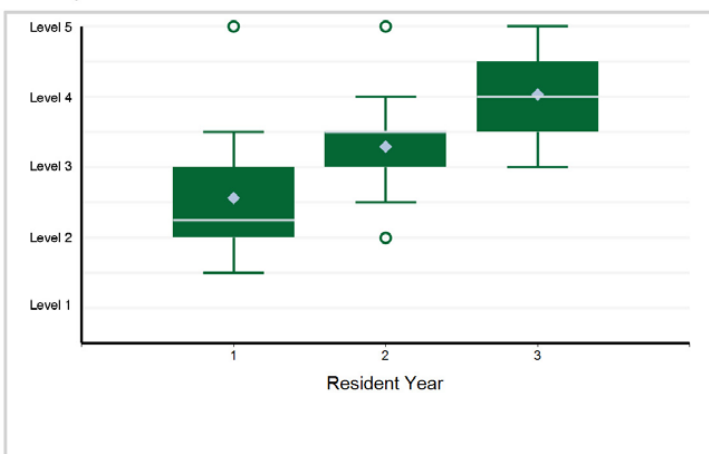

11. Professionalism - Professionalism 1: Patient and Community Interactions

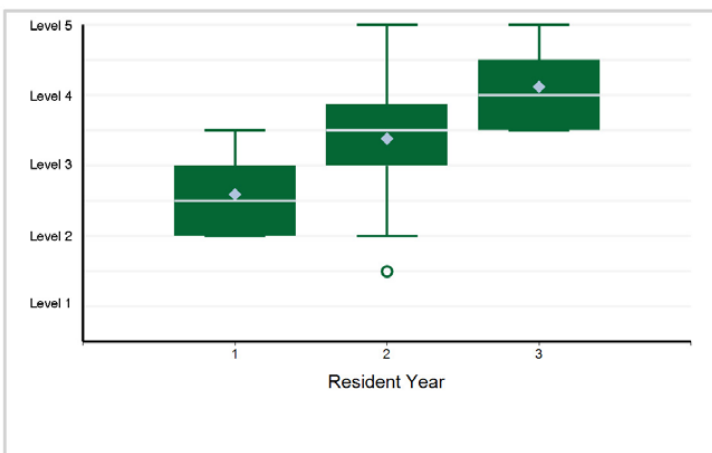

12. Professionalism - Professionalism 2: Professional Conduct and Accountability

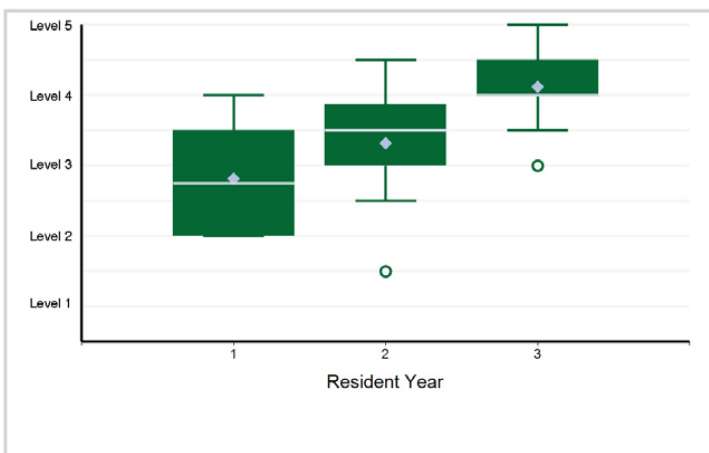

Specialty Box Plot Report - Milestone Evaluation by Resident Year: Year-End 2021-2022

SPECIALTY: Osteopathic Neuromusculoskeletal Medicine

13. Professionalism - Professionalism 3: Maintains emotional, physical, and mental health; and pursues continual ...

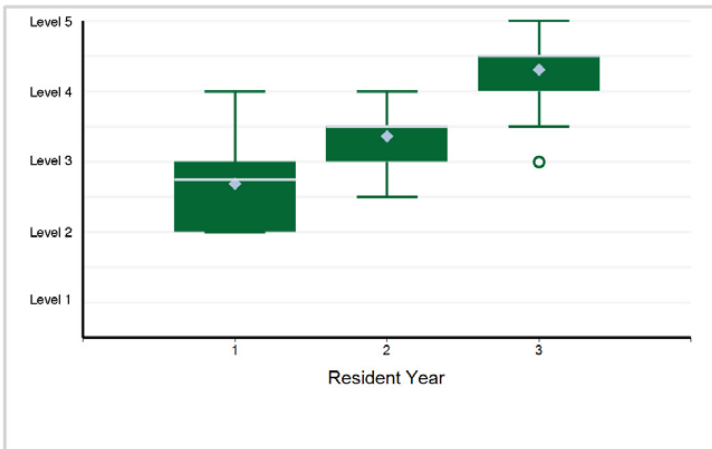

14. Interpersonal and Communication Skills - Interpersonal and Communication Skills 1: Develops Meaningful, ...

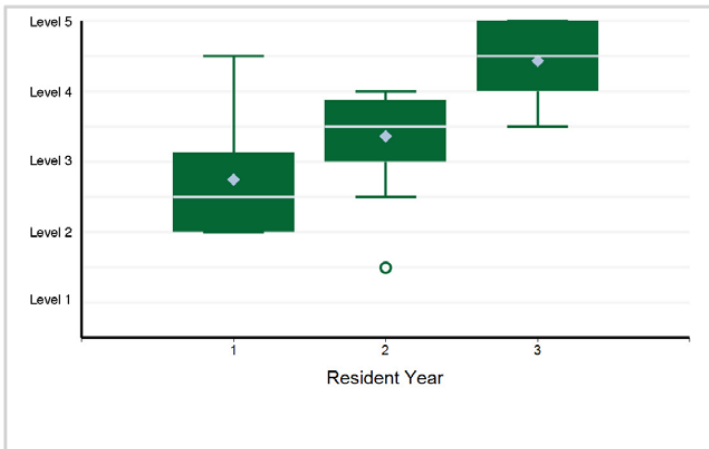

15. Interpersonal and Communication Skills - Interpersonal and Communication Skills 2: Interprofessional Communications

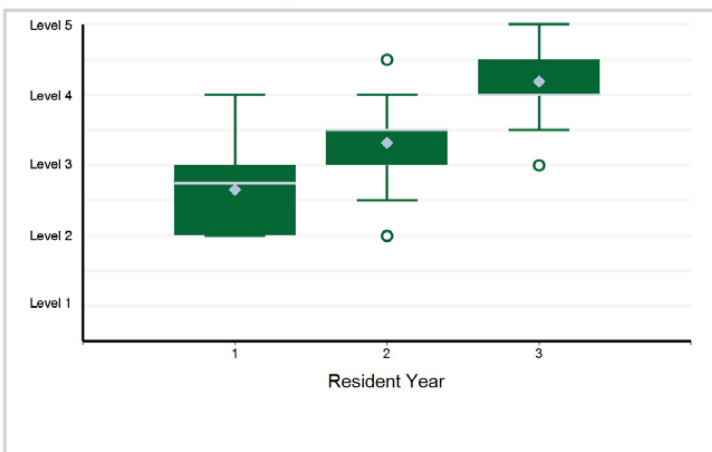

Specialty Box Plot Report - Milestone Evaluation by Resident Year: Year-End 2021-2022

TABLE 79: SPECIALTY: **Otolaryngology - Head and Neck Surgery**

Resident Year	1	2	3	4	5	Total Residents
# of Residents	362	367	349	342	344	1,764

1. Patient Care - Salivary Disease—Patient Care

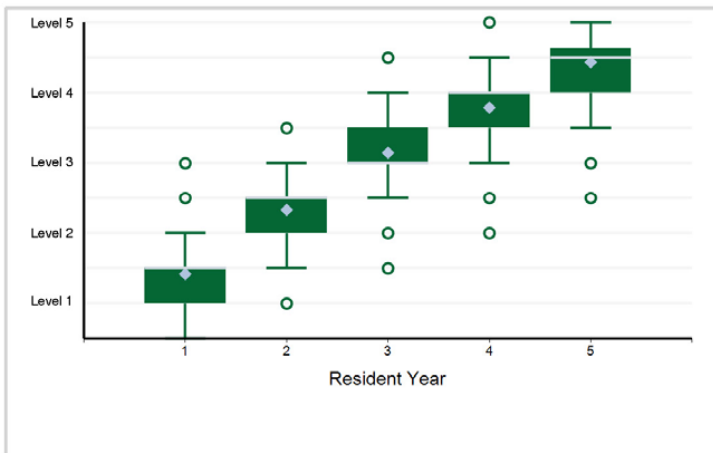

2. Patient Care - Aerodigestive Tract Lesions (ADT)—Patient Care

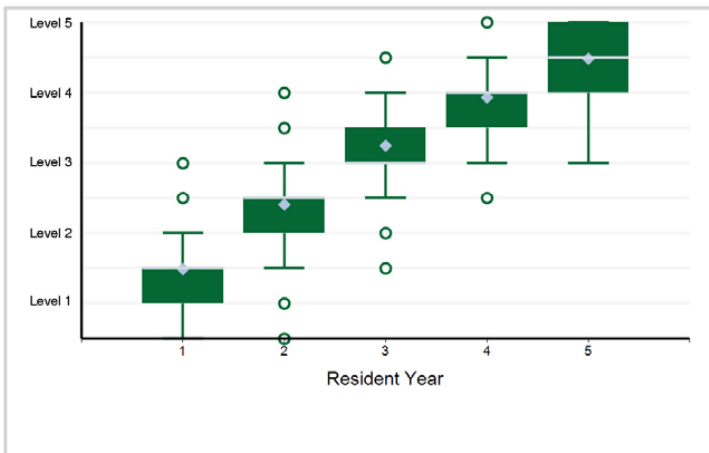

3. Patient Care - Sleep Disordered Breathing (SDB)—Patient Care

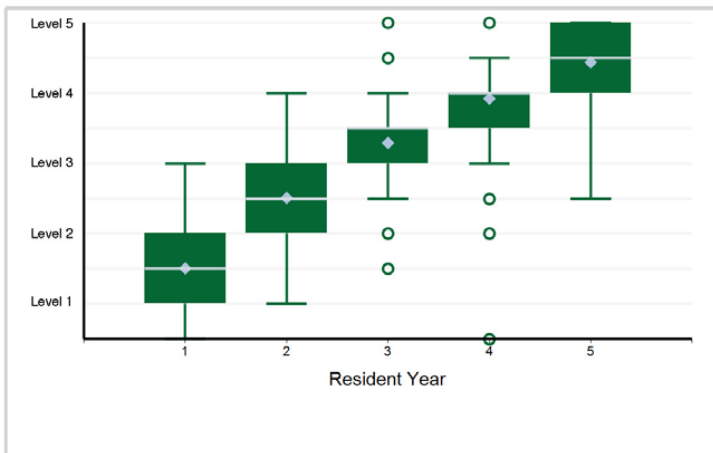

4. Patient Care - Facial Trauma—Patient Care

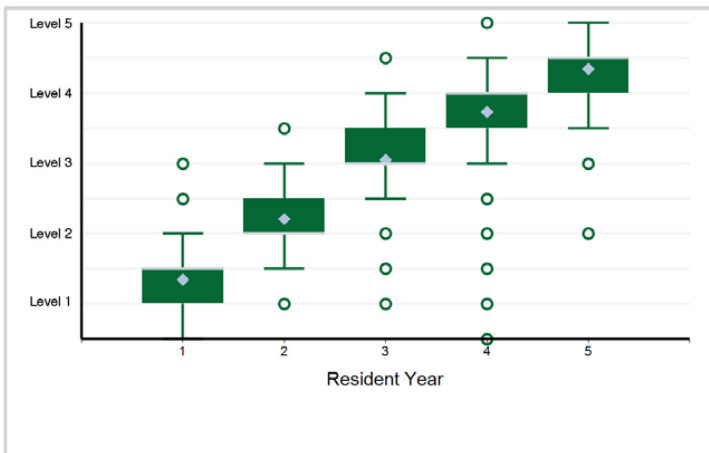

5. Patient Care - Rhinosinusitis—Patient Care

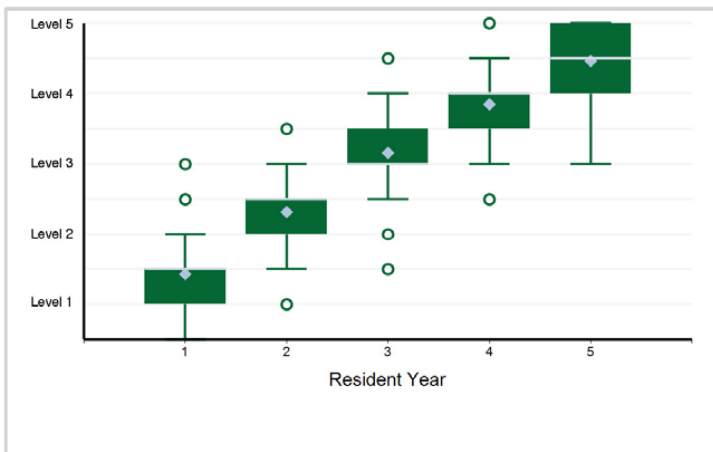

6. Patient Care - Nasal Deformity—Patient Care

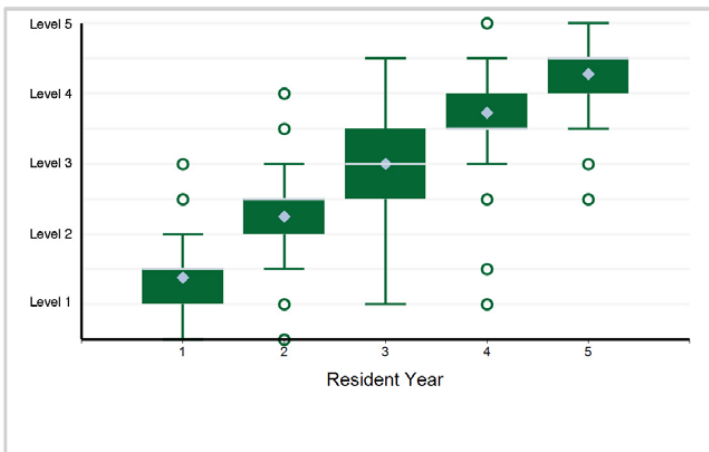

Specialty Box Plot Report - Milestone Evaluation by Resident Year: Year-End 2021-2022

SPECIALTY: Otolaryngology - Head and Neck Surgery

7. Patient Care - Chronic Ear—Patient Care

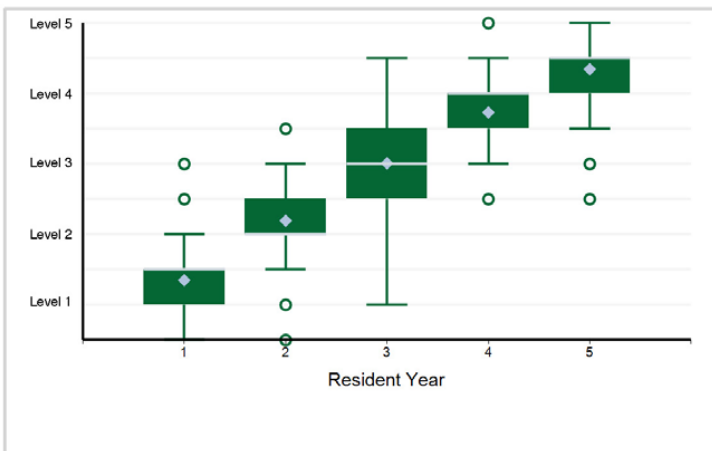

8. Patient Care - Pediatric Otitis Media—Patient Care

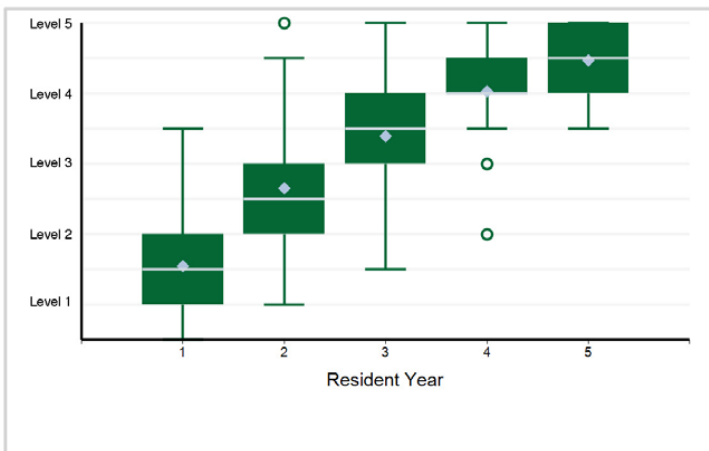

9. Medical Knowledge - Upper Aerodigestive Tract (UADT) Malignancy—Medical Knowledge

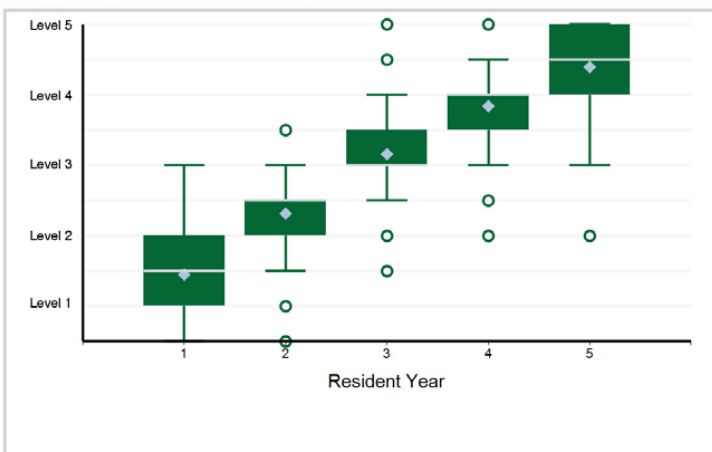

10. Medical Knowledge - Hearing Loss—Medical Knowledge

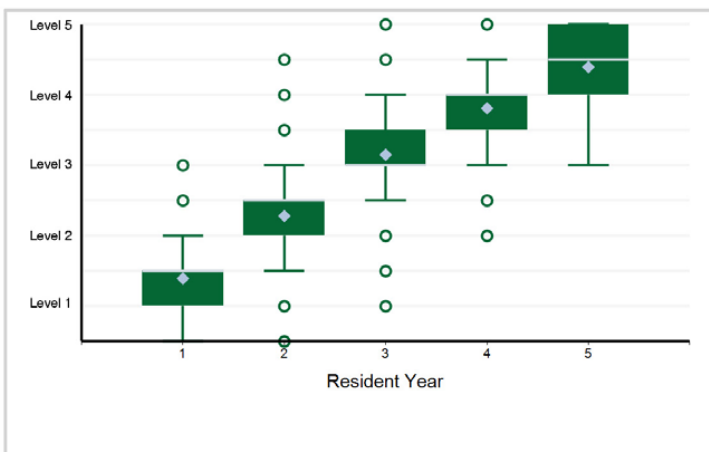

11. Medical Knowledge - Dysphagia-Dysphonia—Medical Knowledge

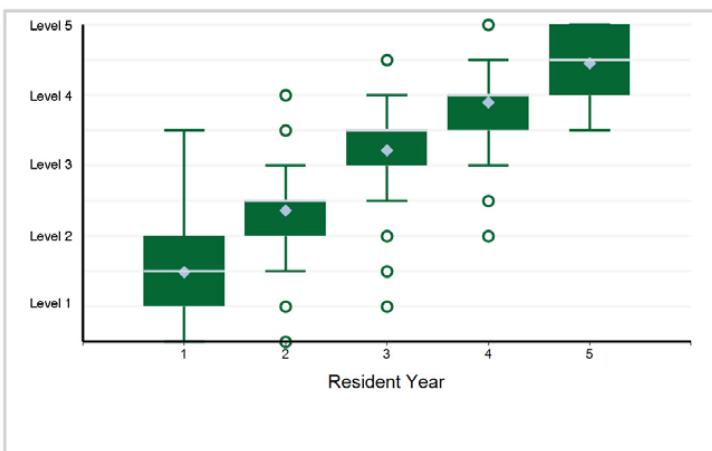

12. Medical Knowledge - Inhalant Allergy—Medical Knowledge

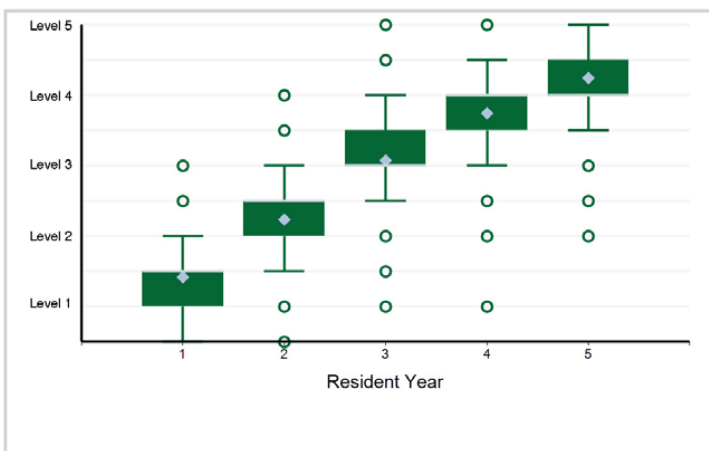

Specialty Box Plot Report - Milestone Evaluation by Resident Year: Year-End 2021-2022

SPECIALTY: Otolaryngology - Head and Neck Surgery

13. Systems-Based Practice - Patient Safety—Systems-Based Practice

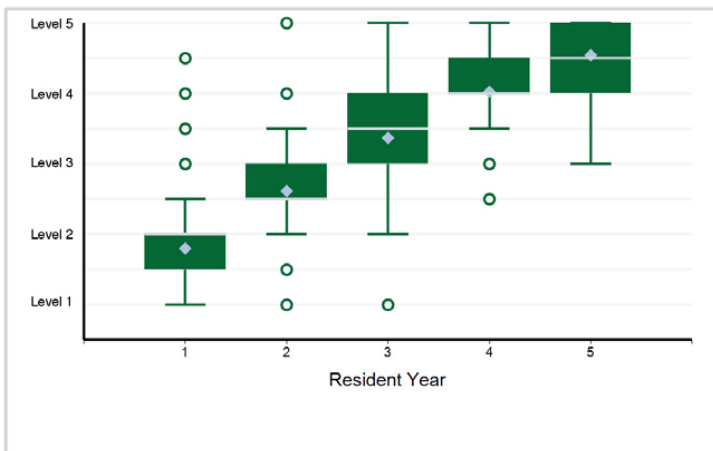

14. Systems-Based Practice - Resource Utilization—Systems-Based Practice

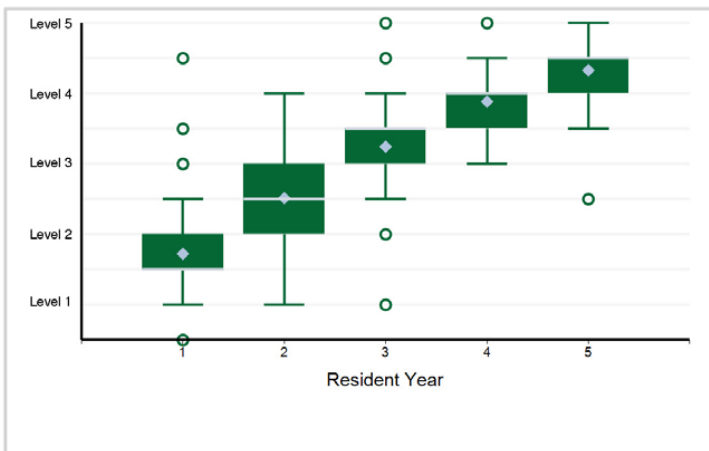

15. Practice-Based Learning and Improvement - The ability to investigate and evaluate the care of patients, to appraise and ...

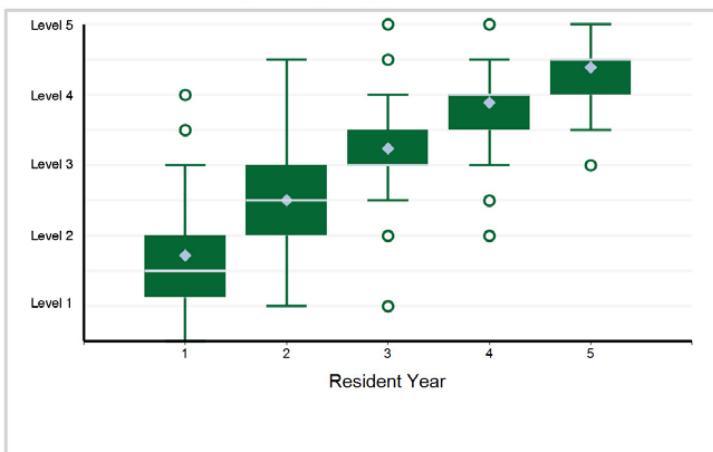

16. Professionalism - Professionalism

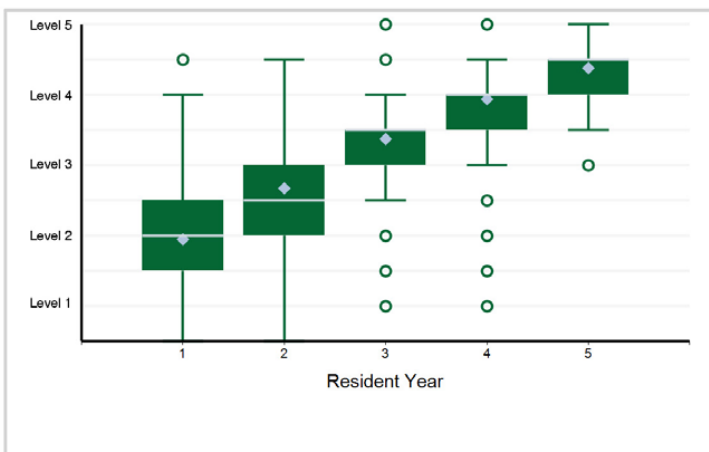

17. Interpersonal and Communication Skills - Interpersonal Communication Skills

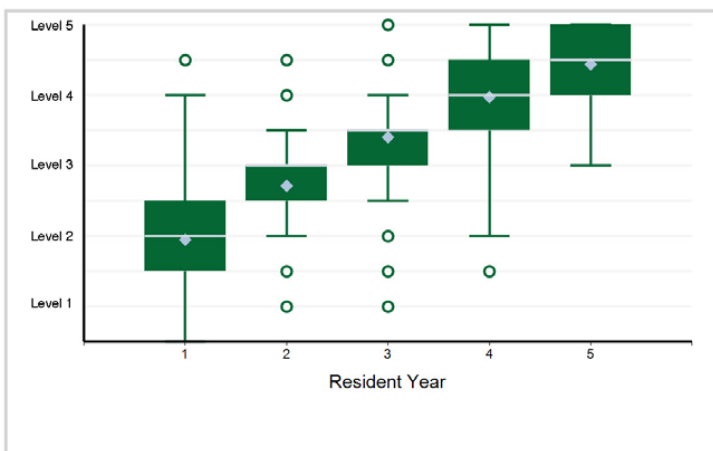

Specialty Box Plot Report - Milestone Evaluation by Resident Year: Year-End 2021-2022

TABLE 80: SUBSPECIALTY: **Neurology**

Resident Year	1	2	Total Residents
# of Residents	20	17	37

1. Patient Care - Internal Auditory Canal (IAC) and Cerebellopontine Angle (CPA) Lesions – Patient Care

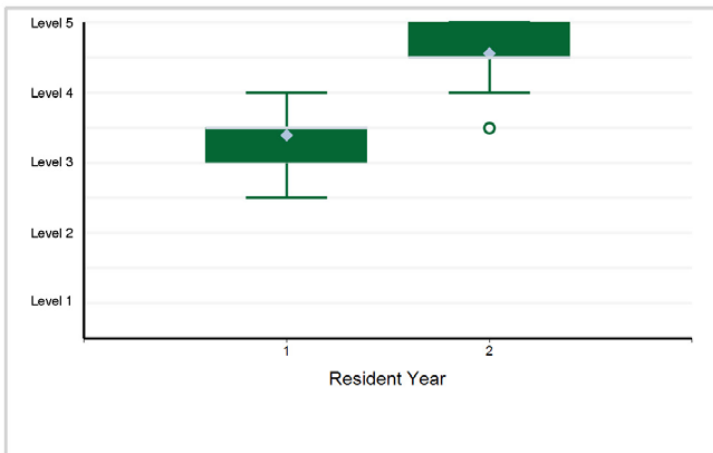

2. Patient Care - Lateral Skull Base Tumors – Patient Care

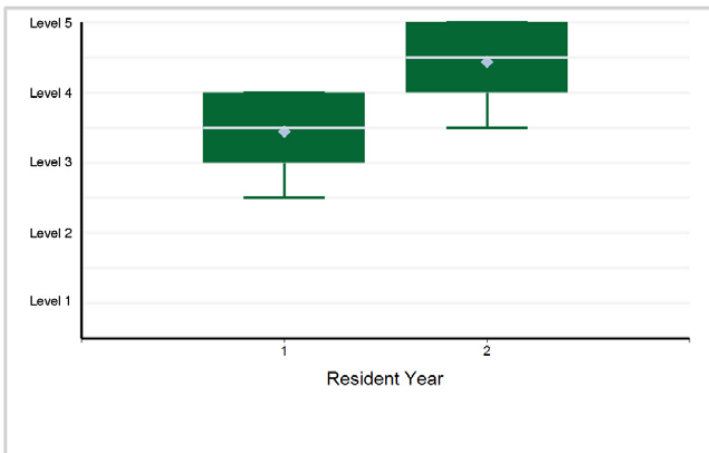

3. Patient Care - Facial Nerve Disorders – Patient Care

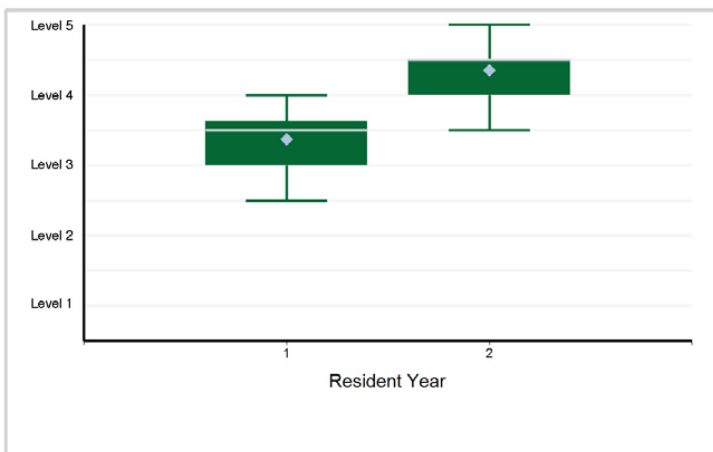

4. Medical Knowledge - Hearing Loss – Medical Knowledge

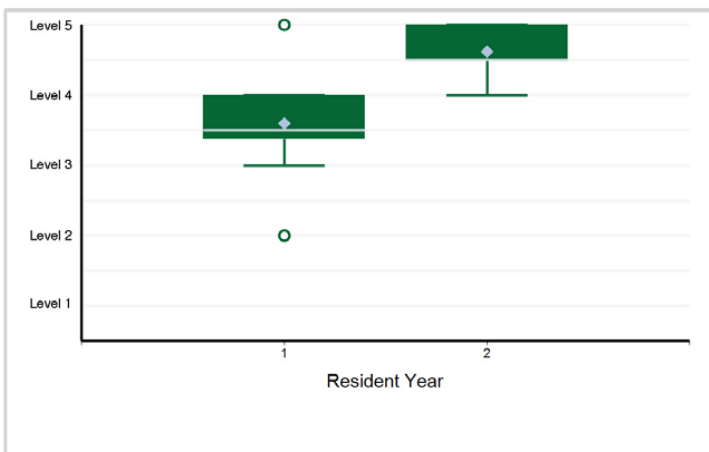

5. Medical Knowledge - Dizziness – Medical Knowledge

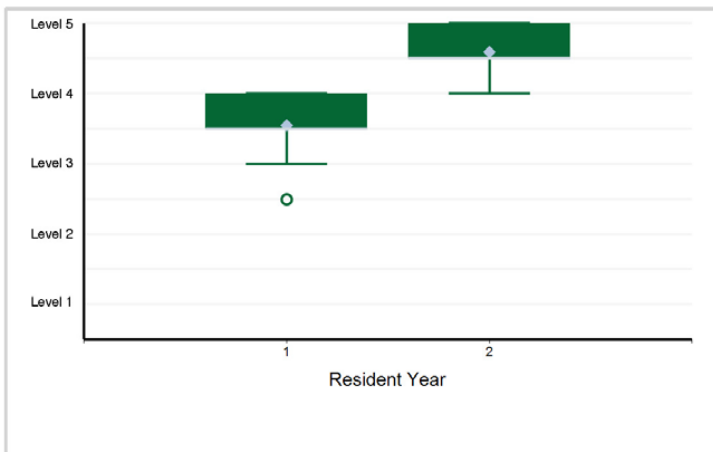

6. Systems-Based Practice - Patient Safety – Systems-Based Practice

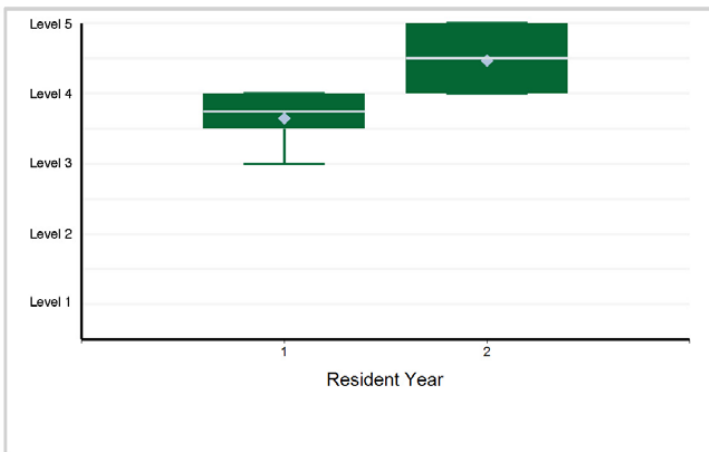

Specialty Box Plot Report - Milestone Evaluation by Resident Year: Year-End 2021-2022

SUBSPECIALTY: Neurotology

7. Systems-Based Practice - Resource Utilization – Systems-Based Practice

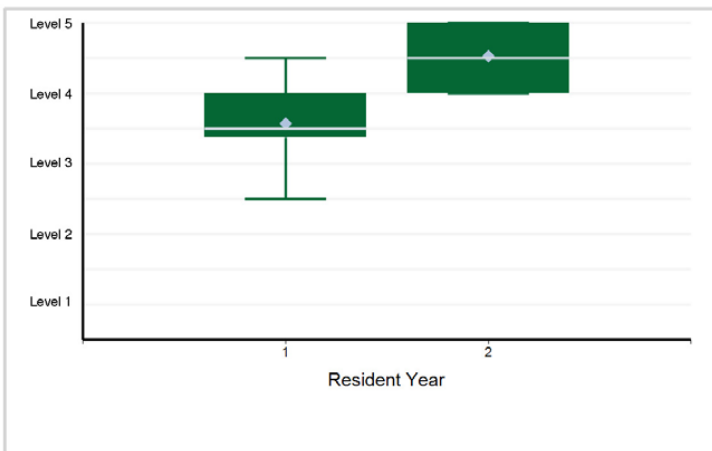

8. Practice-Based Learning and Improvement - Evidence-based Medicine – Practice-Based Learning and Improvement

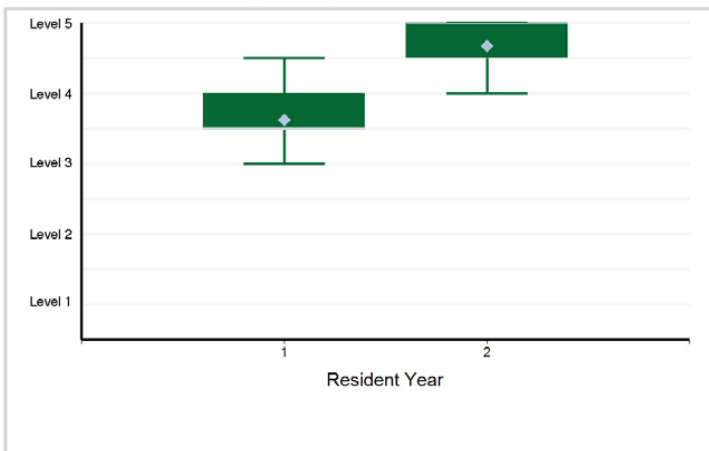

9. Practice-Based Learning and Improvement - Self-directed Learning – Practice-Based Learning and Improvement

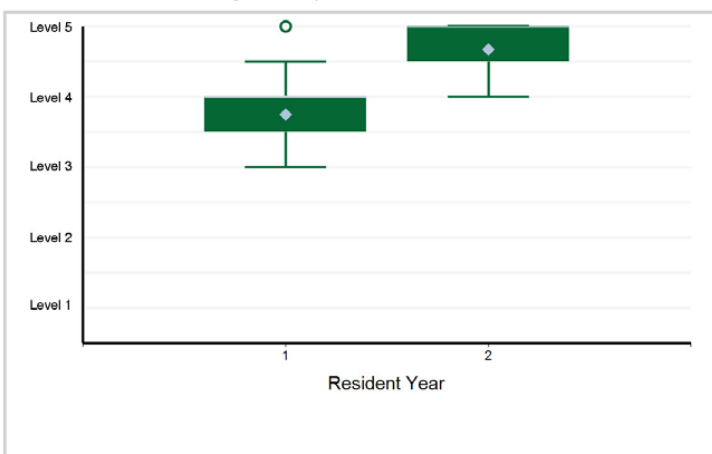

10. Professionalism - Behavior – Professionalism

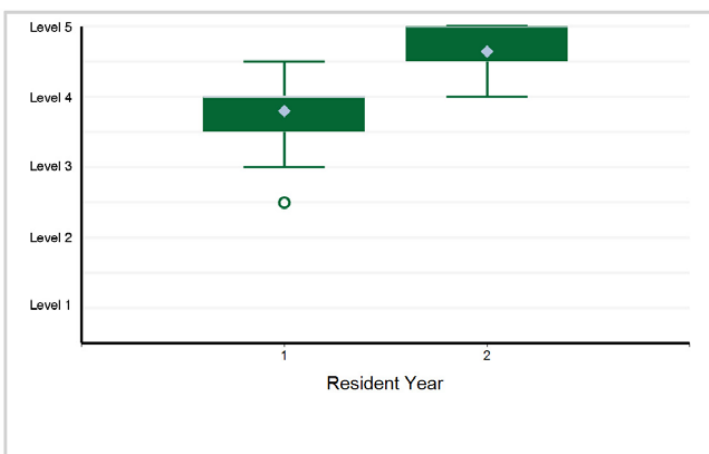

11. Professionalism - Leadership – Professionalism

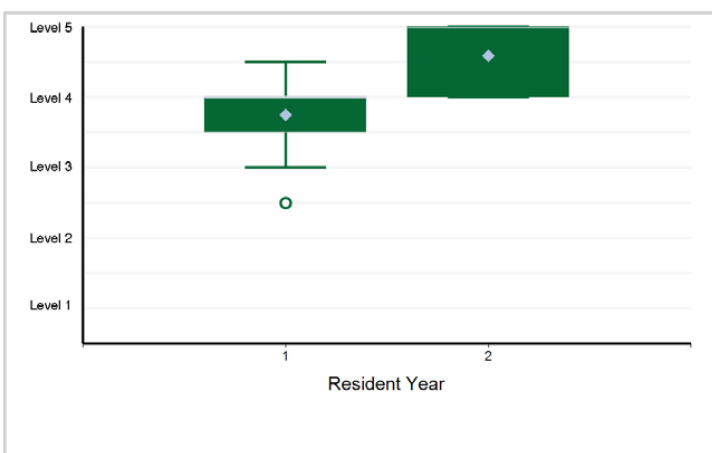

12. Interpersonal and Communication Skills - Health Care Team Communications – Interpersonal and Communication Skills

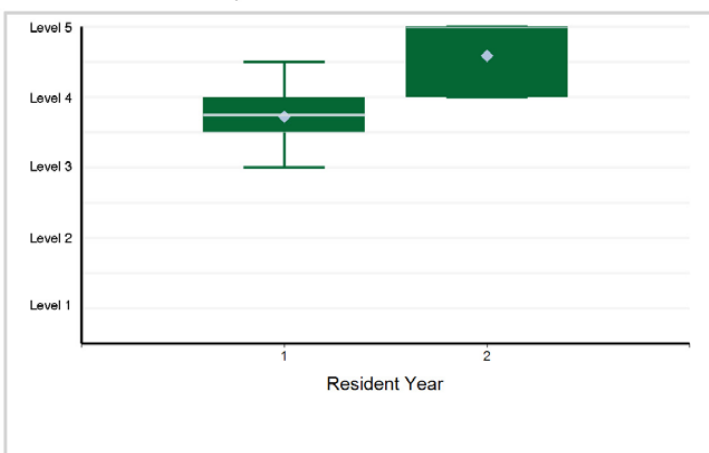

Specialty Box Plot Report - Milestone Evaluation by Resident Year: Year-End 2021-2022

SUBSPECIALTY: **Neurology**

13. Interpersonal and Communication Skills - Patient- and Family-centered Care – Interpersonal and Communication Skills

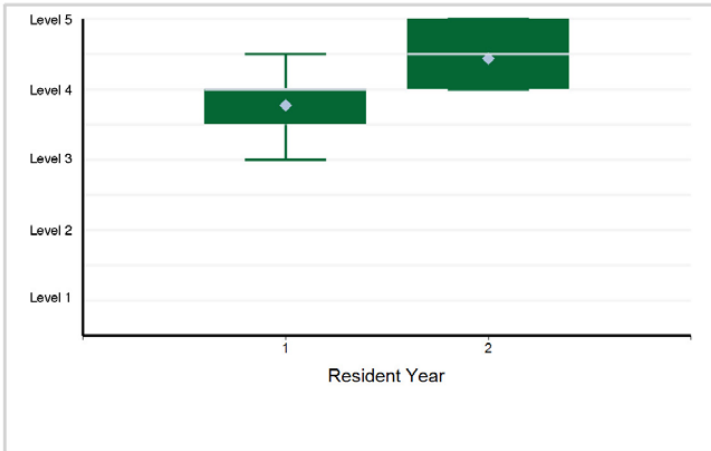

Specialty Box Plot Report - Milestone Evaluation by Resident Year: Year-End 2021-2022

TABLE 81: SUBSPECIALTY: **Pediatric Otolaryngology**

Resident Year	1	Total Residents*
# of Residents	42	42

*Note: There are 1 residents with an incomplete milestone evaluation that are excluded from the box plots below.

1. Patient Care - Airway Management – Patient Care

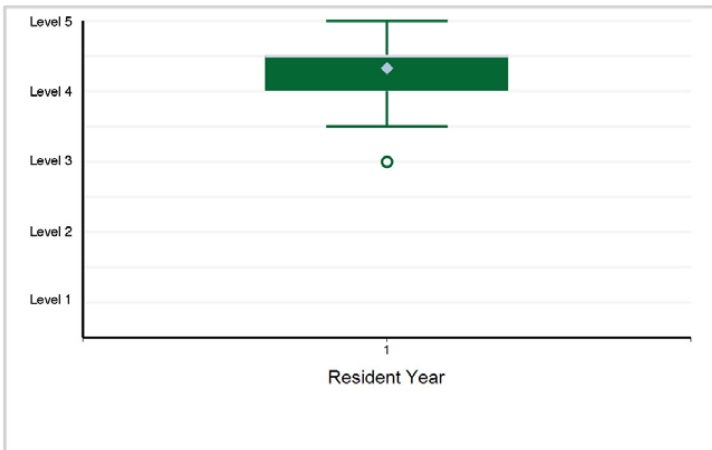

2. Patient Care - Pediatric Neck Mass – Patient Care

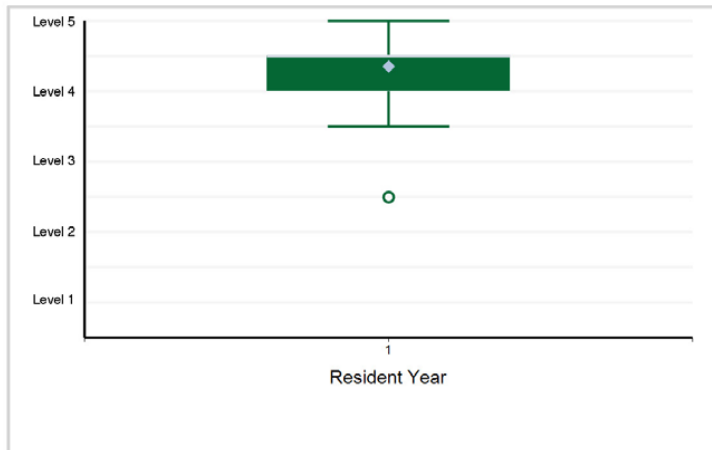

3. Patient Care - Rhinology – Patient Care

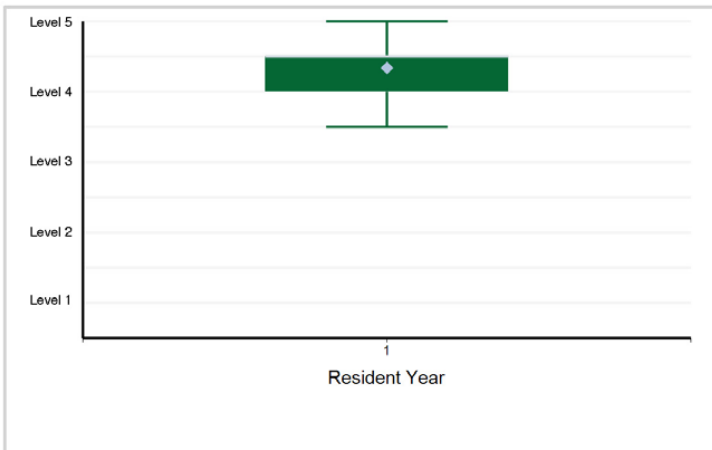

4. Medical Knowledge - Hearing Loss — Medical Knowledge

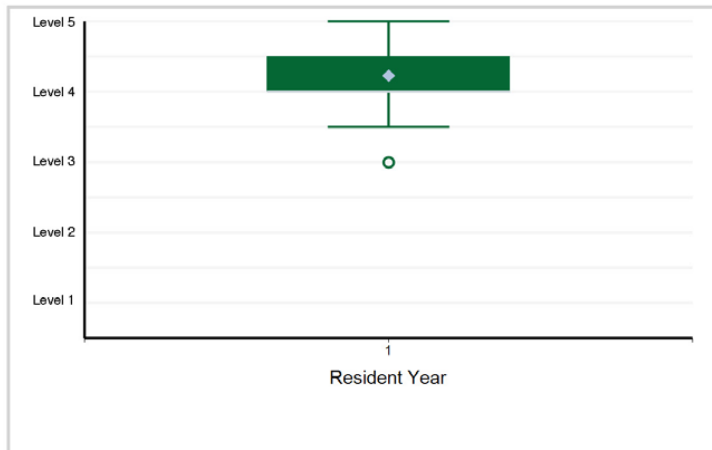

5. Medical Knowledge - Craniofacial Conditions — Medical Knowledge



6. Systems-Based Practice - Patient Safety — Systems-Based Practice

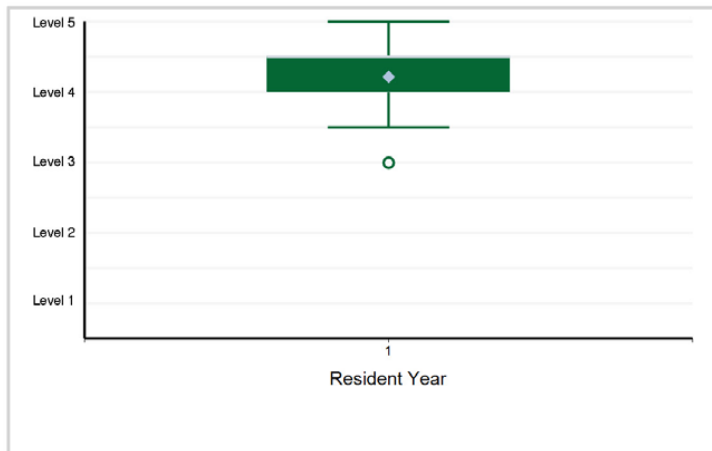

Specialty Box Plot Report - Milestone Evaluation by Resident Year: Year-End 2021-2022

SUBSPECIALTY: Pediatric Otolaryngology

7. Systems-Based Practice - Resource Utilization — Systems-Based Practice

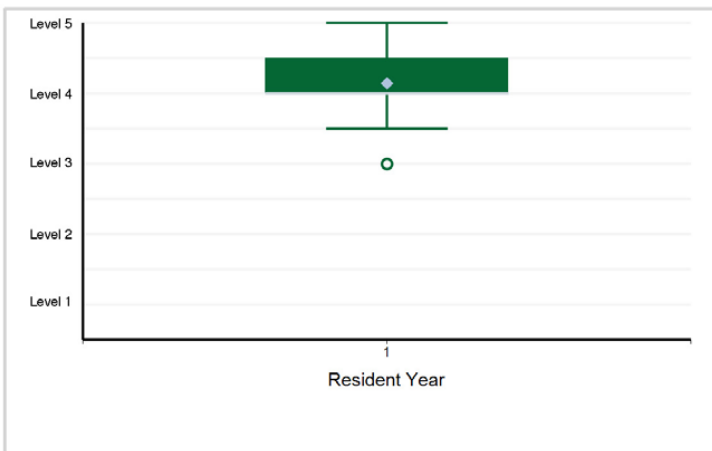

8. Practice-Based Learning and Improvement - Evidence-based Medicine — Practice-Based Learning and Improvement

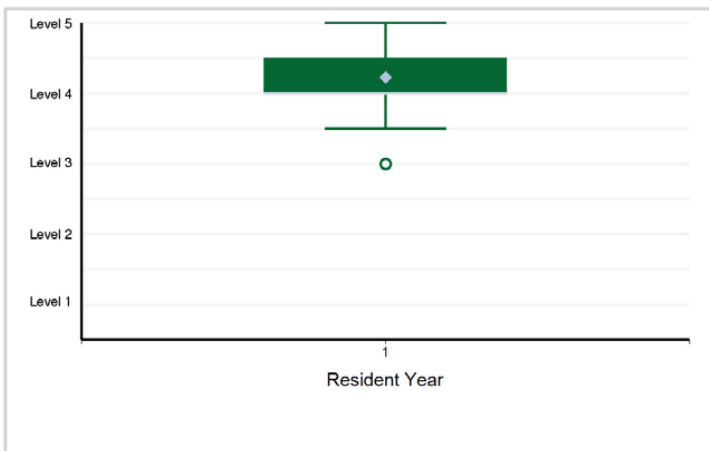

9. Practice-Based Learning and Improvement - Self-directed Learning — Practice-Based Learning and Improvement

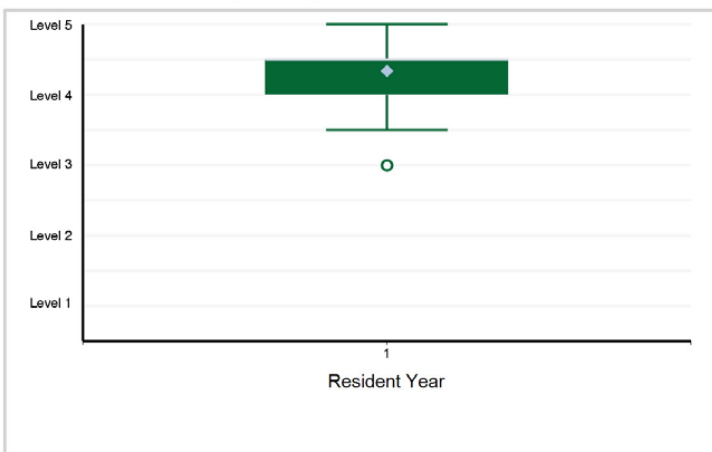

10. Professionalism - Behavior – Professionalism

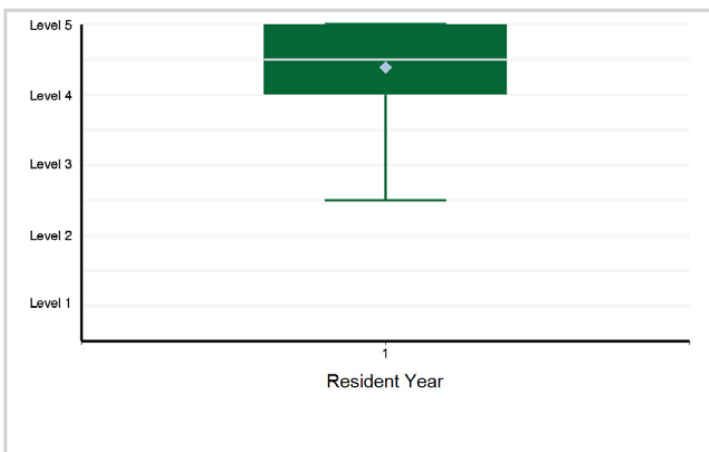

11. Professionalism - Leadership — Professionalism

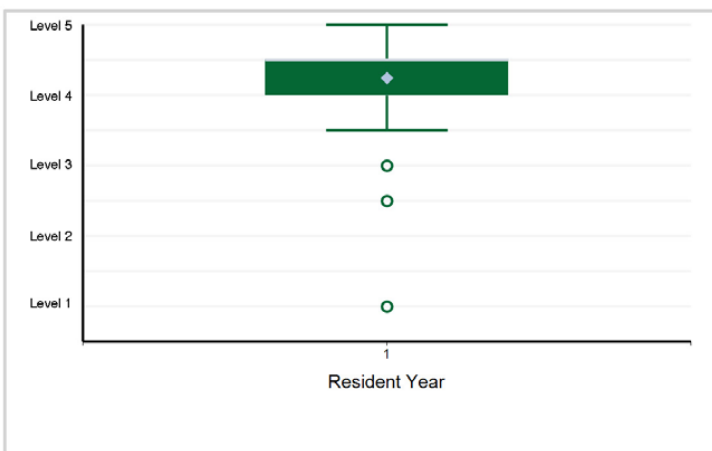

12. Interpersonal and Communication Skills - Health Care Team Communications — Interpersonal and Communication Skills

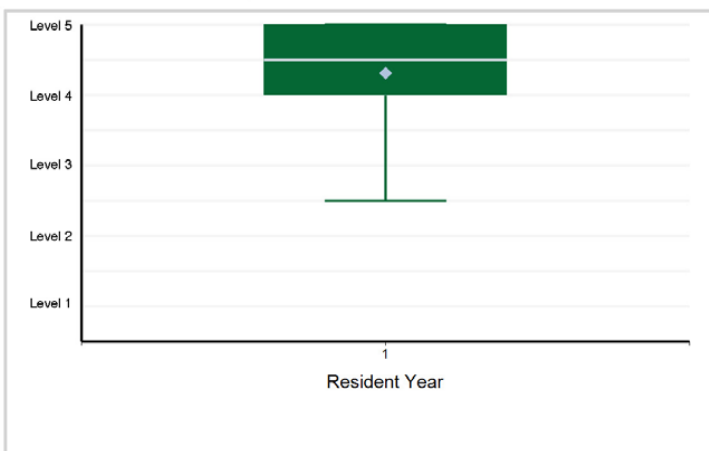

Specialty Box Plot Report - Milestone Evaluation by Resident Year: Year-End 2021-2022

SUBSPECIALTY: Pediatric Otolaryngology

13. Interpersonal and Communication Skills - Patient- and Family-centered Care — Interpersonal and Communication Skills

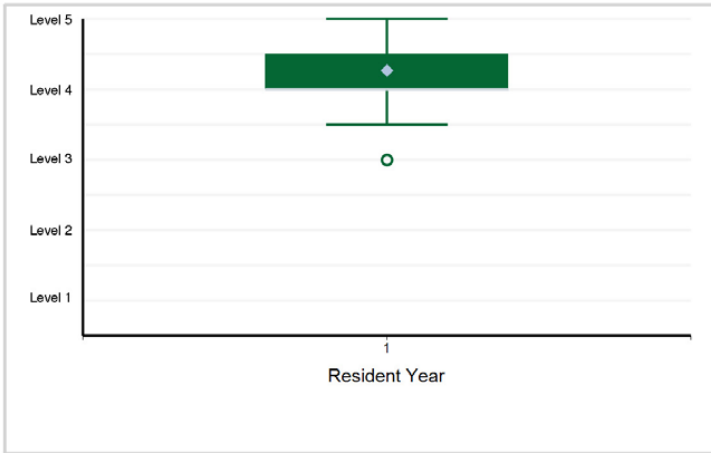

Specialty Box Plot Report - Milestone Evaluation by Resident Year: Year-End 2021-2022

TABLE 82: SPECIALTY: **Pathology - Anatomic and Clinical**

Resident Year	1	2	3	4	Total Residents
# of Residents	628	611	594	514	2,347

1. Patient Care - 1: Reporting (Anatomic Pathology/Clinical Pathology [AP/CP])

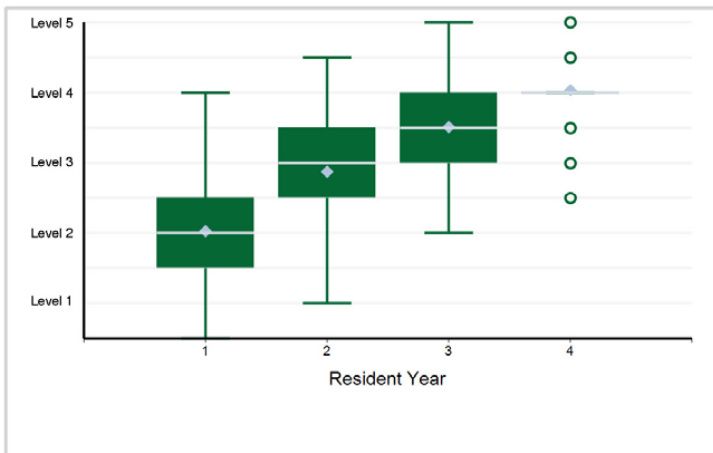

2. Patient Care - 2: Grossing (AP)

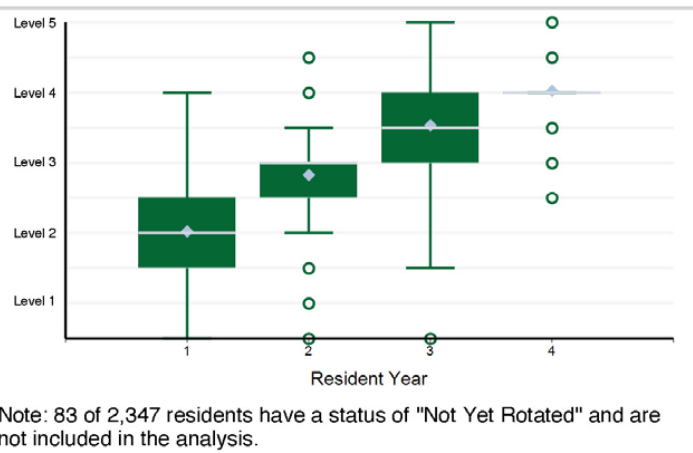

3. Patient Care - 3: Clinical Consultation, including On-Call Interactions (AP/CP)

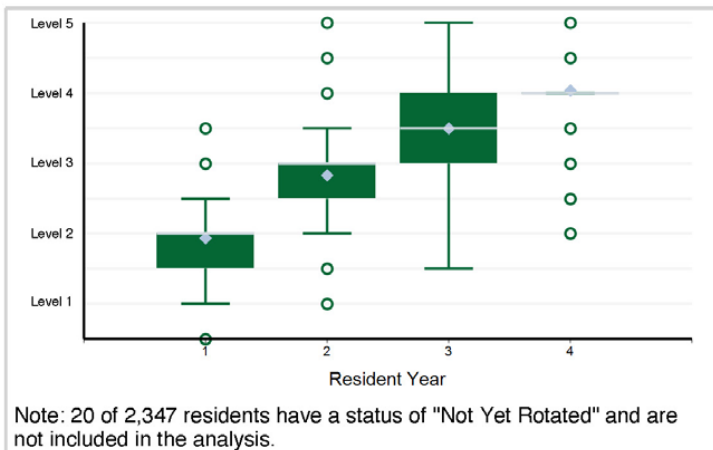

4. Patient Care - 4: Interpretation and Diagnosis (AP/CP)

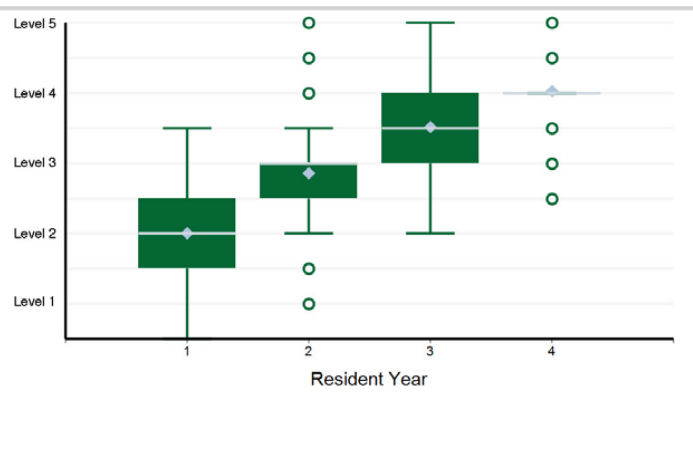

5. Patient Care - 5: Intra-Operative Consultation (IOC), including Frozen Section (FS) (AP)

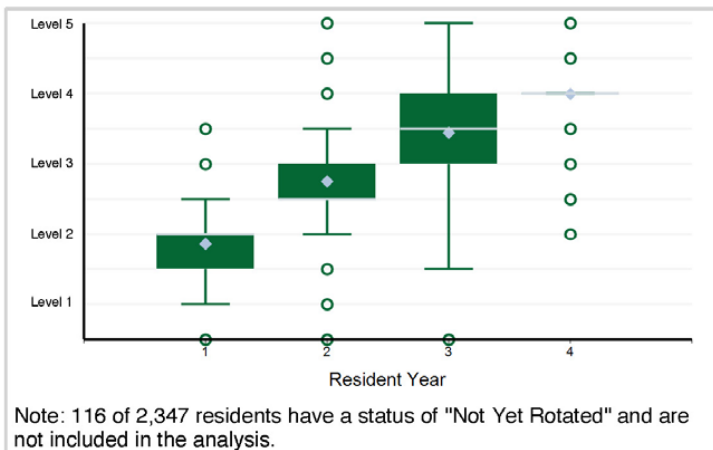

6. Patient Care - 6: Autopsy (AP)

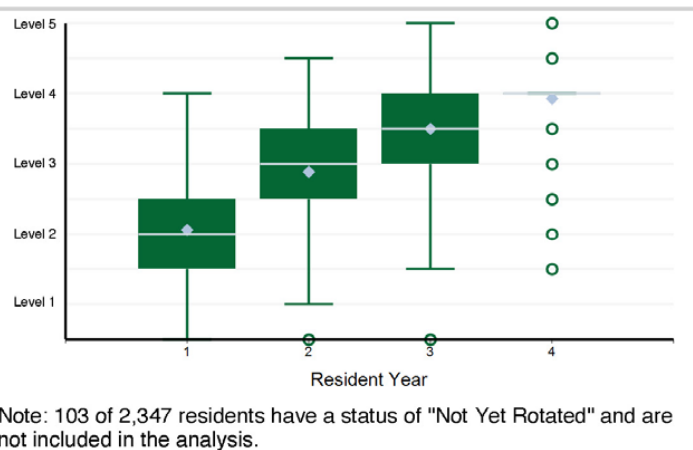

Specialty Box Plot Report - Milestone Evaluation by Resident Year: Year-End 2021-2022

SPECIALTY: Pathology - Anatomic and Clinical

7. Medical Knowledge - 1: Diagnostic Knowledge (AP/CP)

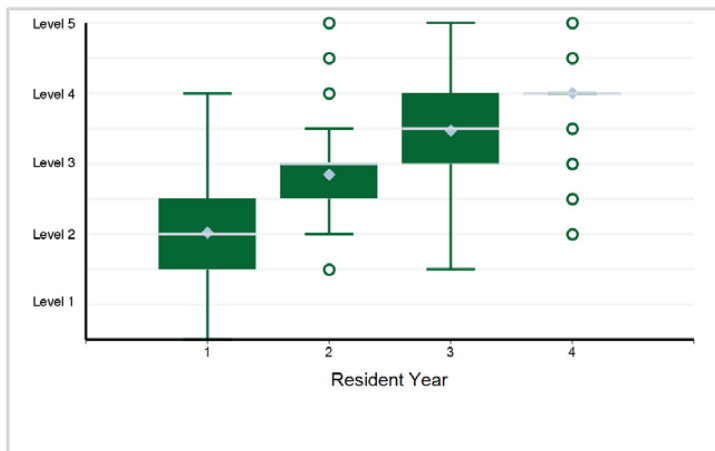

8. Medical Knowledge - 2: Clinical Reasoning (AP/CP)

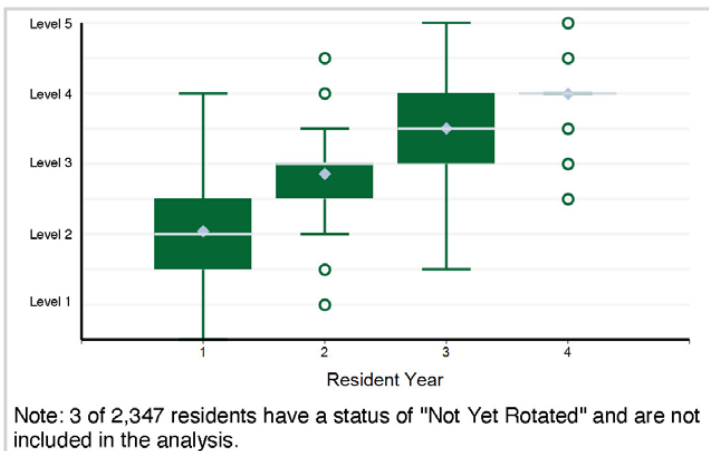

9. Systems-Based Practice - 1: Patient Safety and Quality Improvement (QI) (AP/CP)

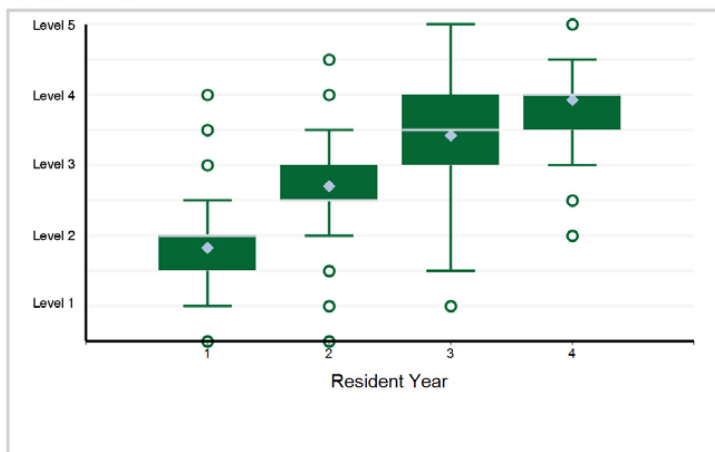

10. Systems-Based Practice - 2: Systems Navigation for Patient-Centered Care (AP/CP)

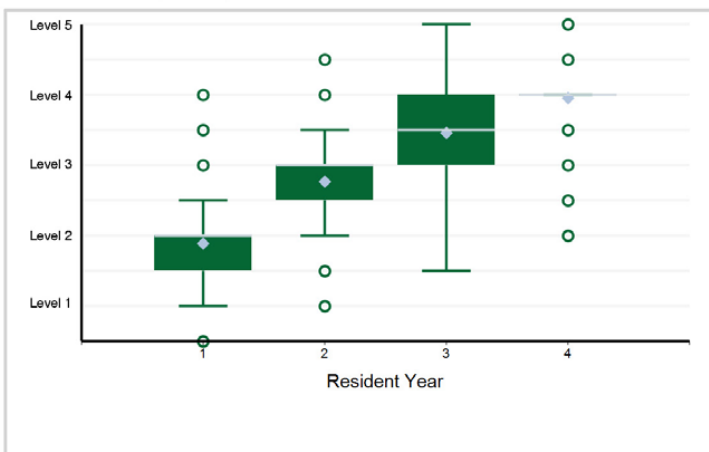

11. Systems-Based Practice - 3: Physician Role in Health Care System (AP/CP)

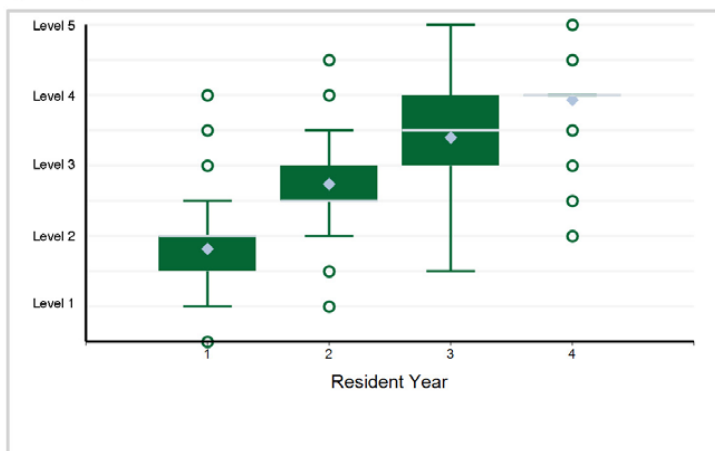

12. Systems-Based Practice - 4: Informatics (AP/CP)

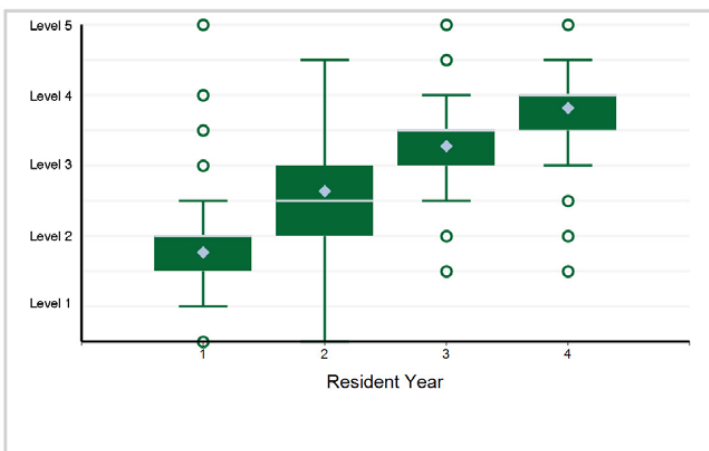

Specialty Box Plot Report - Milestone Evaluation by Resident Year: Year-End 2021-2022

SPECIALTY: Pathology - Anatomic and Clinical

13. Systems-Based Practice - 5: Accreditation, Compliance, and Quality (AP/CP)

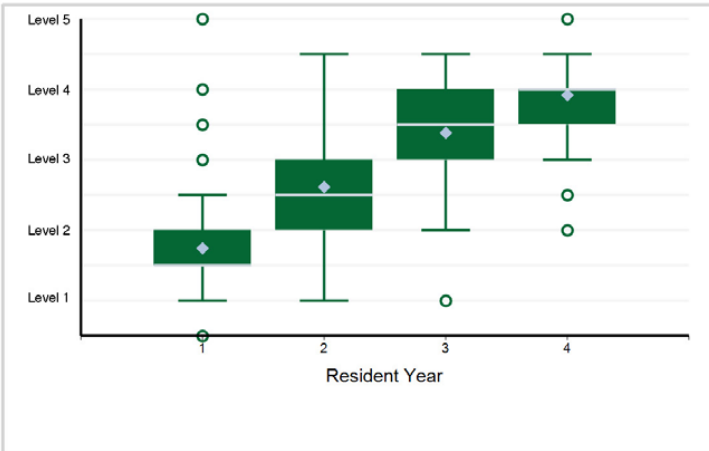

14. Practice-Based Learning and Improvement - 1: Evidence-Based Practice and Scholarship (AP/CP)

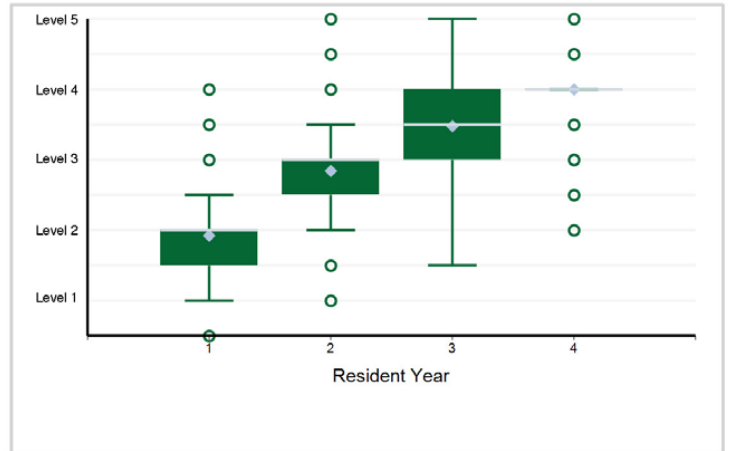

15. Practice-Based Learning and Improvement - 2: Reflective Practice and Commitment to Personal Growth (AP/CP)

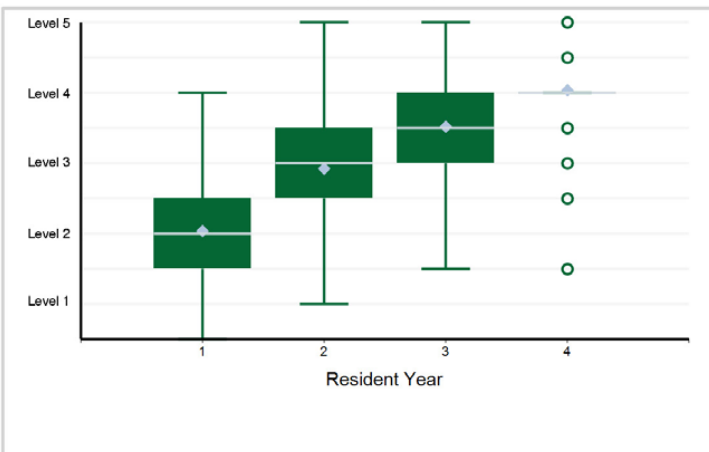

16. Professionalism - 1: Professional Behavior and Ethical Principles (AP/CP)

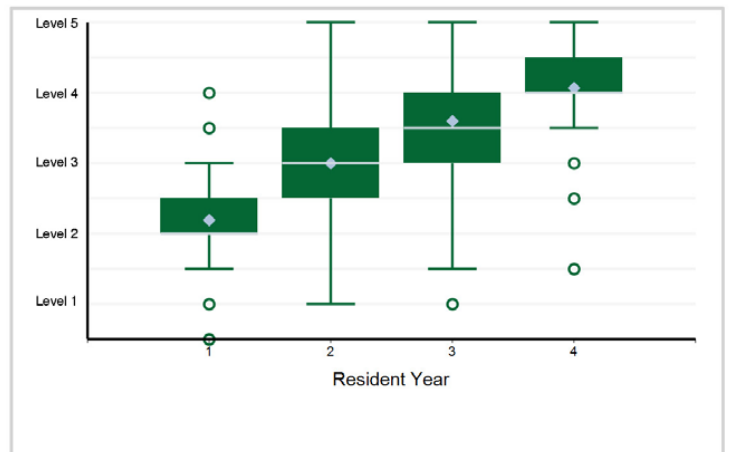

17. Professionalism - 2: Accountability and Conscientiousness (AP/CP)

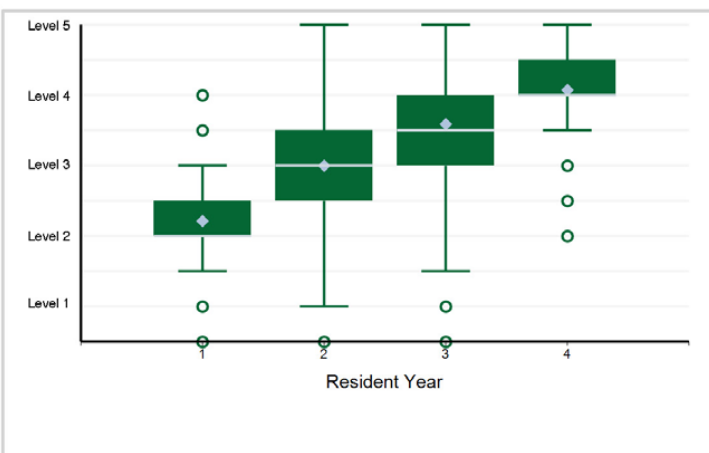

18. Professionalism - 3: Self-Awareness and Help-Seeking (AP/CP)

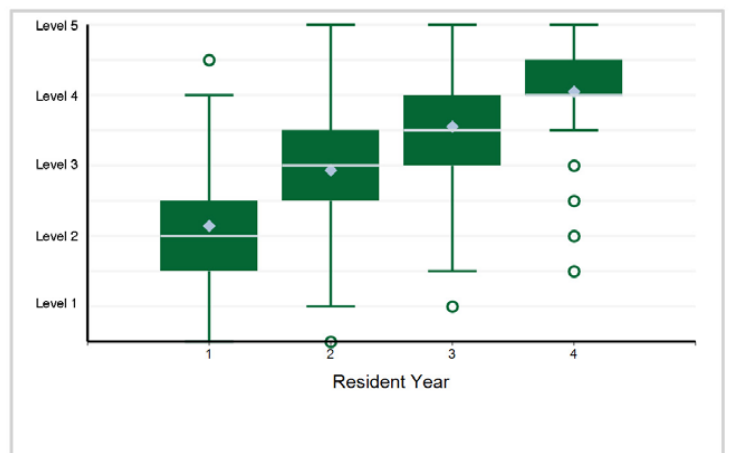

Specialty Box Plot Report - Milestone Evaluation by Resident Year: Year-End 2021-2022

SPECIALTY: Pathology - Anatomic and Clinical

19. Interpersonal and Communication Skills - 1: Patient and Family-Centered Communication (AP/CP)

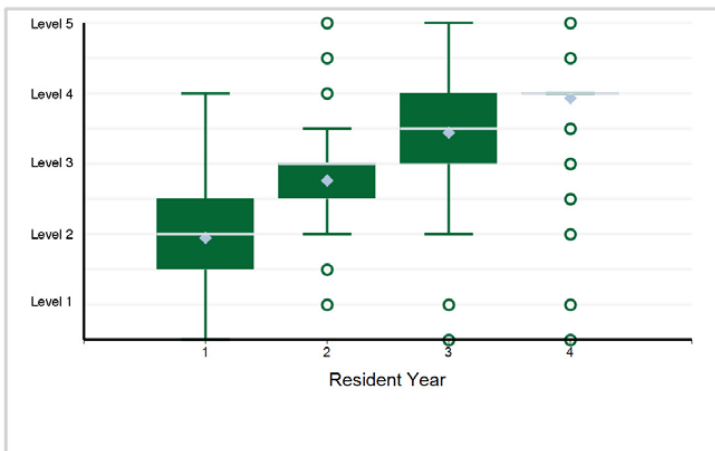

20. Interpersonal and Communication Skills - 2: Interprofessional and Team Communication (AP/CP)

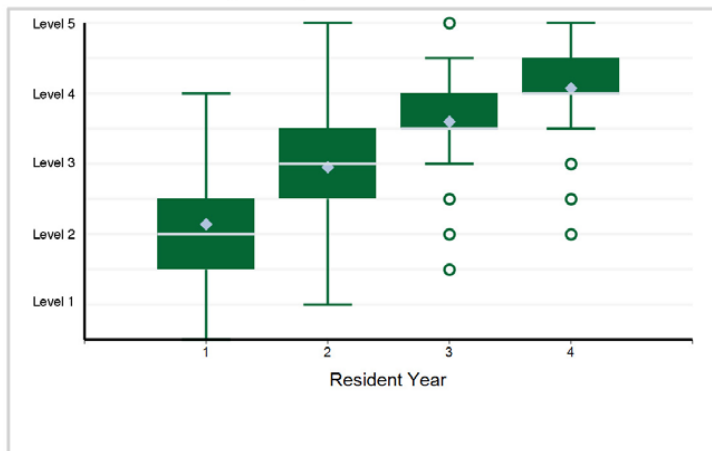

21. Interpersonal and Communication Skills - 3: Communication within Health Care Systems (AP/CP)

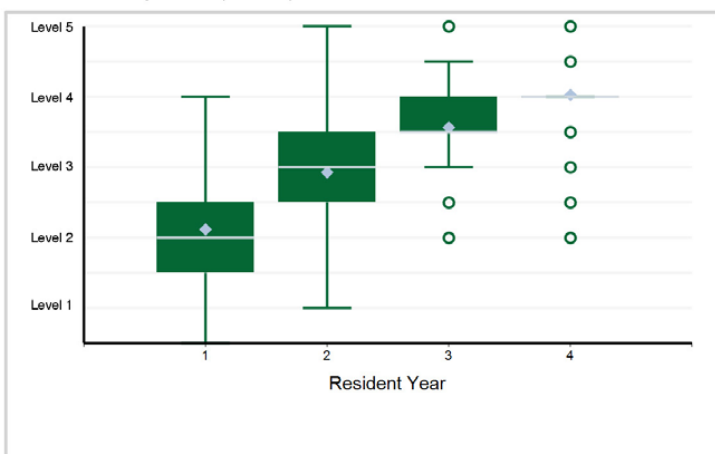

Specialty Box Plot Report - Milestone Evaluation by Resident Year: Year-End 2021-2022

TABLE 83: SUBSPECIALTY: **Blood Banking/Transfusion Medicine**

Resident Year	1	Total Residents
# of Residents	45	45

1. Patient Care - Patient Care 1: Consultation

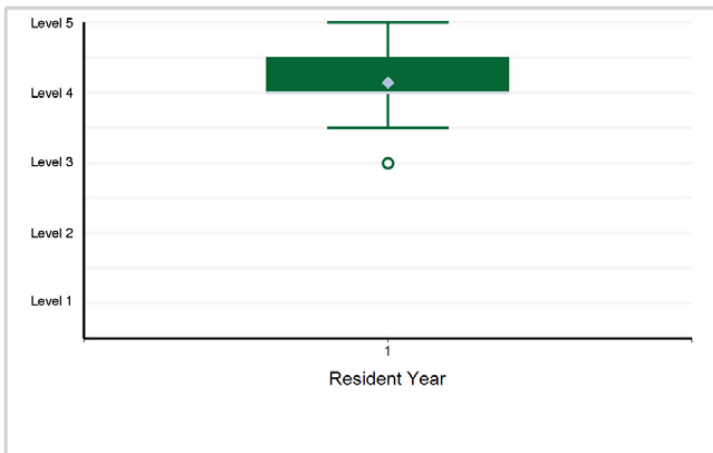

2. Patient Care - Patient Care 2: Therapeutic and Donor Procedures

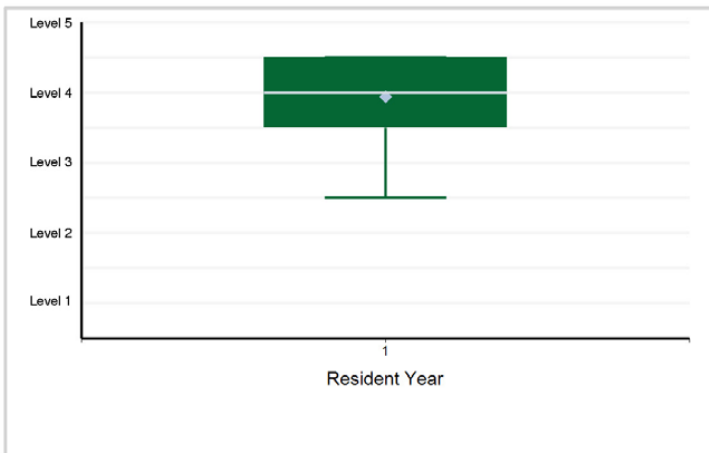

3. Patient Care - Patient Care 3: Interpretation and Diagnosis

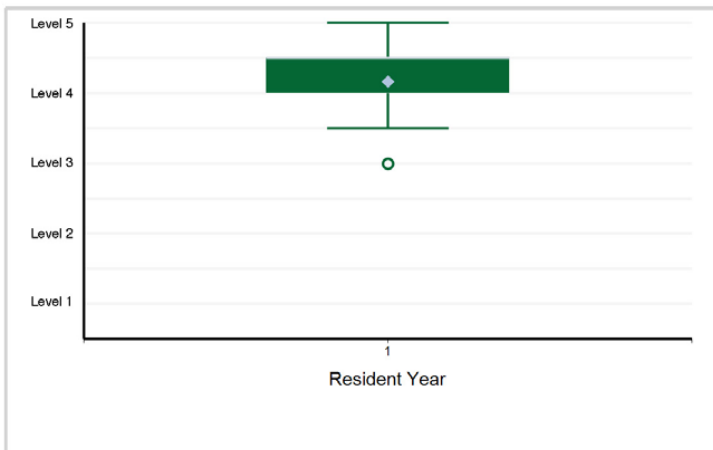

4. Patient Care - Patient Care 4: Reporting

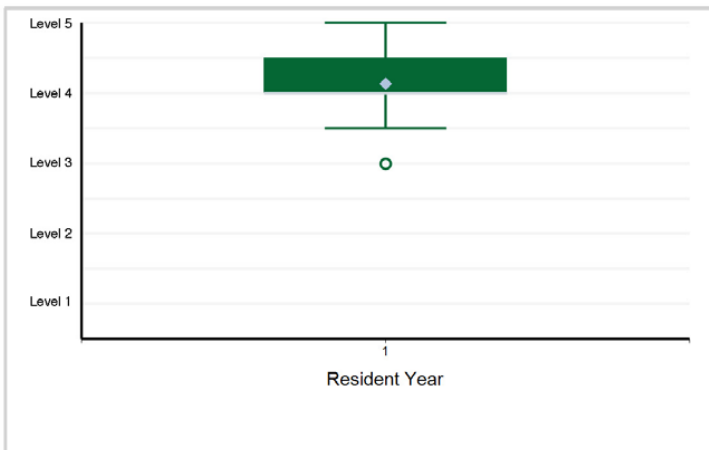

5. Medical Knowledge - Medical Knowledge 1: Immunohematology Testing

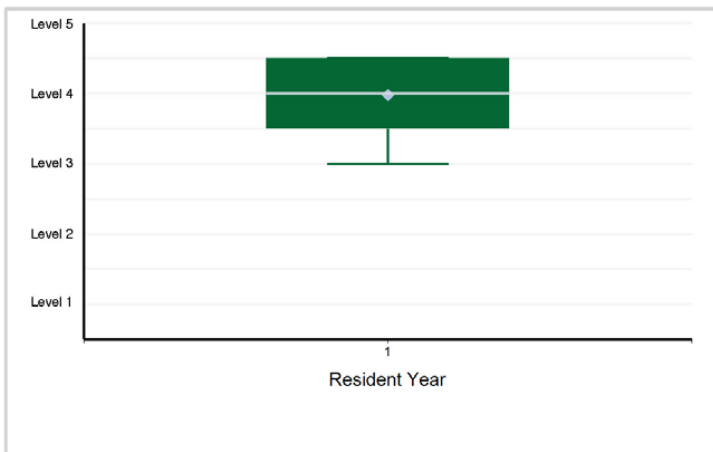

6. Medical Knowledge - Medical Knowledge 2: Donor Management and Component Manufacture



Specialty Box Plot Report - Milestone Evaluation by Resident Year: Year-End 2021-2022

SUBSPECIALTY: Blood Banking/Transfusion Medicine

7. Medical Knowledge - Medical Knowledge 3: Apheresis

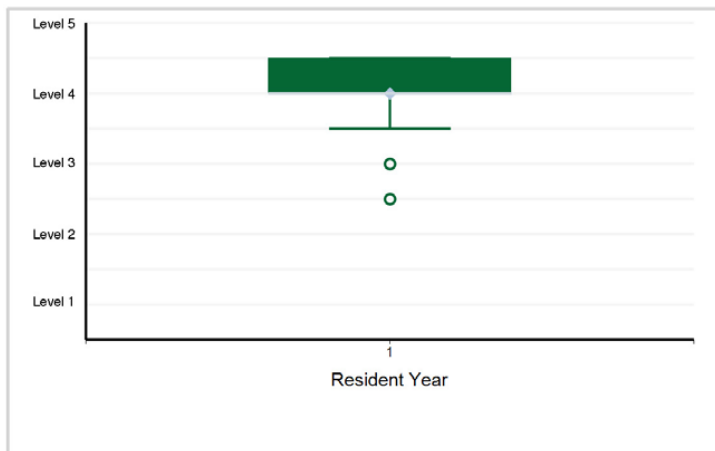

8. Medical Knowledge - Medical Knowledge 4: Transfusion Practice

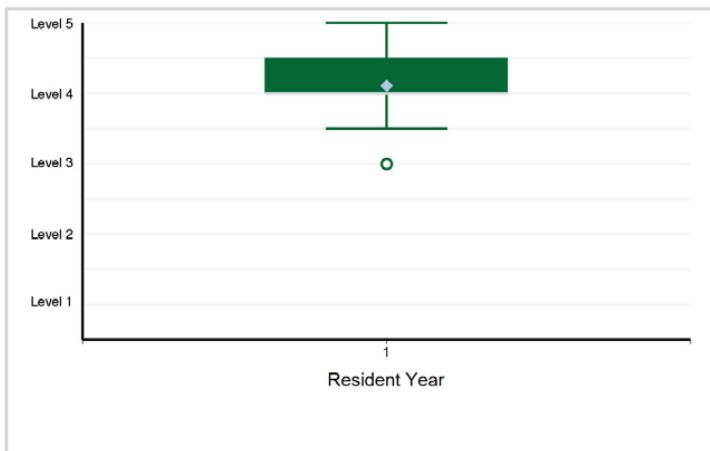

9. Medical Knowledge - Medical Knowledge 5: Cellular Therapy and Transplantation

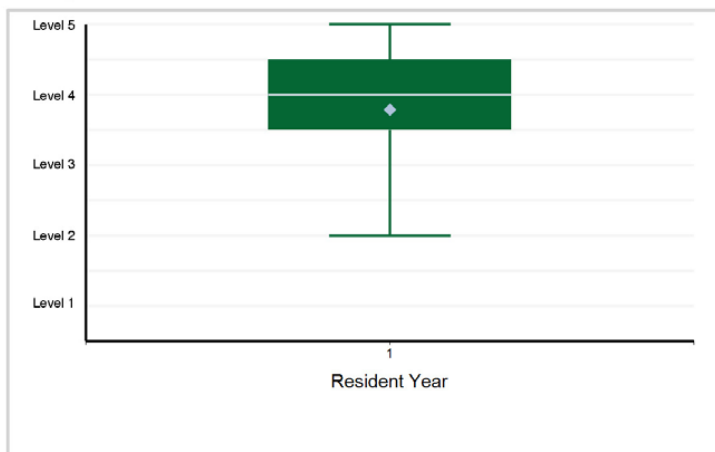

10. Medical Knowledge - Medical Knowledge 6: Clinical Reasoning

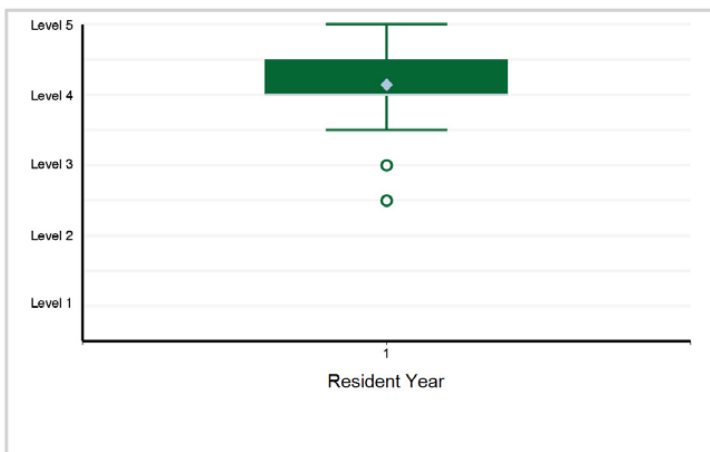

11. Systems-Based Practice - Systems-Based Practice 1: Patient Safety and Quality Improvement (QI)

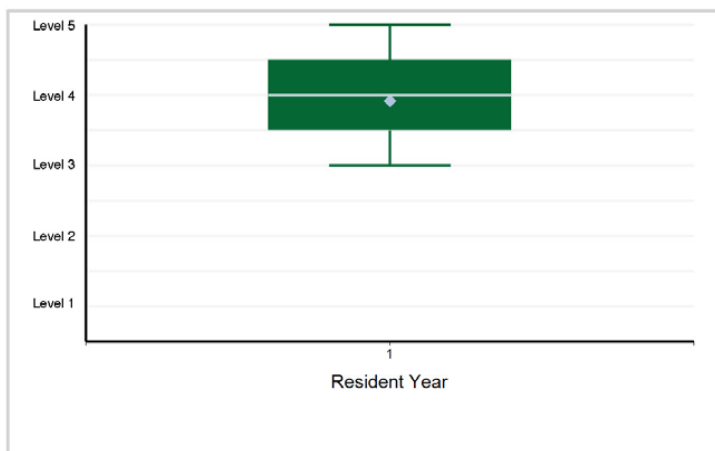

12. Systems-Based Practice - Systems-Based Practice 2: Systems Navigation for Patient-Centered Care

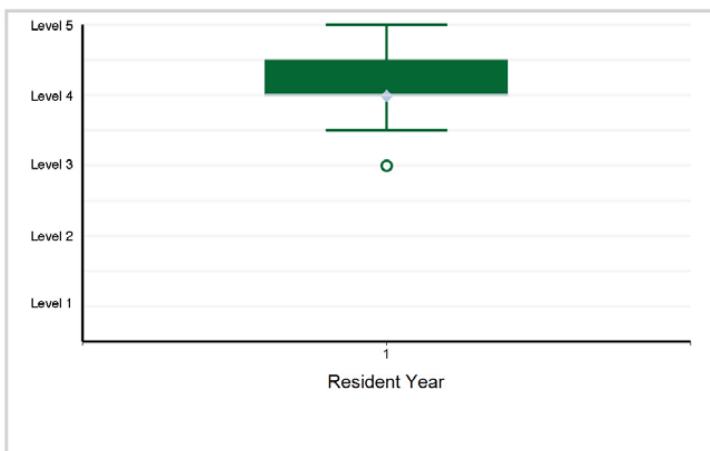

Specialty Box Plot Report - Milestone Evaluation by Resident Year: Year-End 2021-2022

SUBSPECIALTY: Blood Banking/Transfusion Medicine

13. Systems-Based Practice - Systems-Based Practice 3: Physician Role in Health Care System

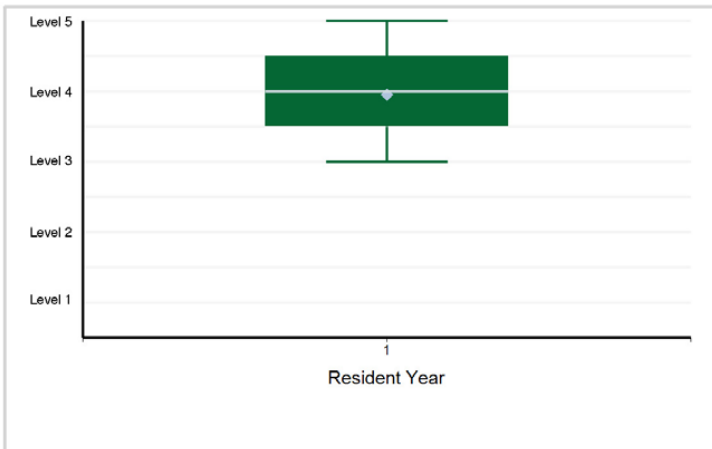

14. Systems-Based Practice - Systems-Based Practice 4: Accreditation, Compliance, and Quality



15. Systems-Based Practice - Systems-Based Practice 5: Utilization

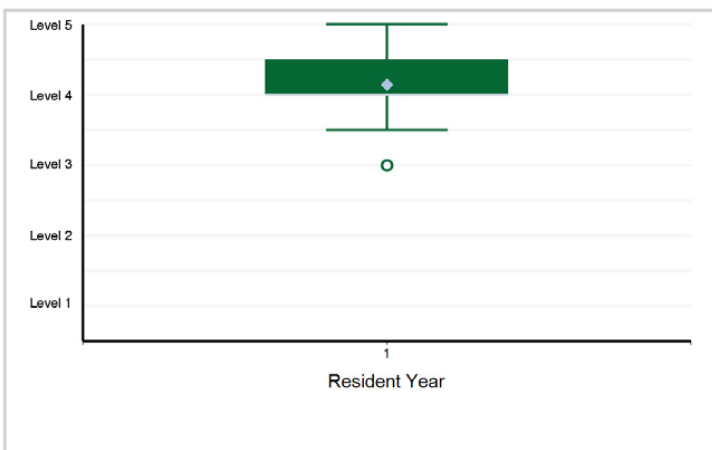

16. Practice-Based Learning and Improvement - Practice-Based Learning and Improvement 1: Evidence-Based Practice and Scholarship

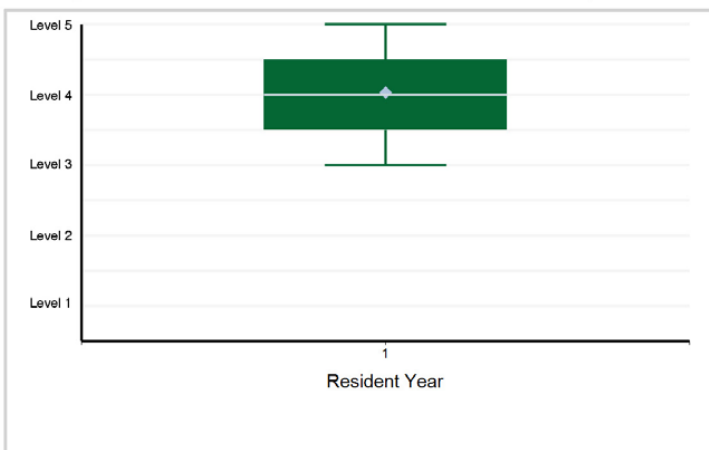

17. Practice-Based Learning and Improvement - Practice-Based Learning and Improvement 2: Reflective Practice and Commitment ...

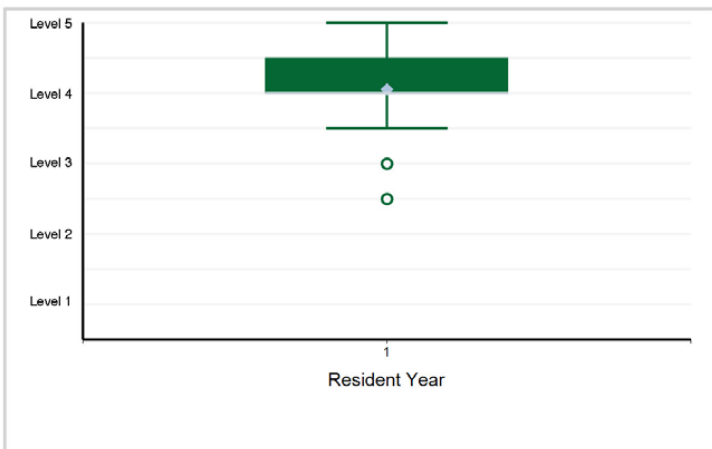

18. Professionalism - Professionalism 1: Professional Behavior and Ethical Principles

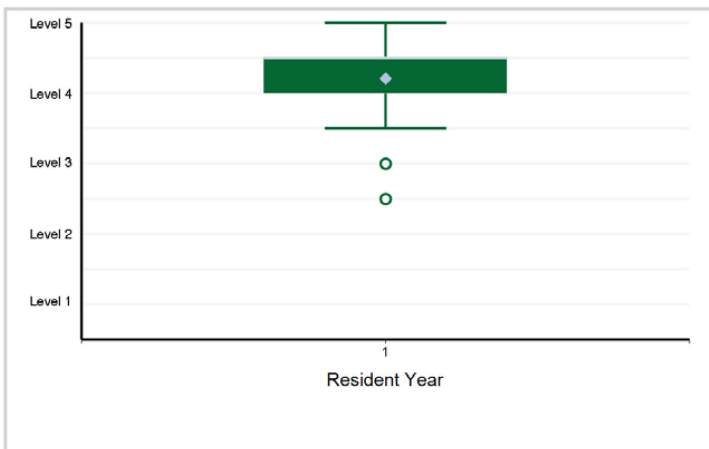

Specialty Box Plot Report - Milestone Evaluation by Resident Year: Year-End 2021-2022

SUBSPECIALTY: Blood Banking/Transfusion Medicine

19. Professionalism - Professionalism 2: Accountability and Conscientiousness

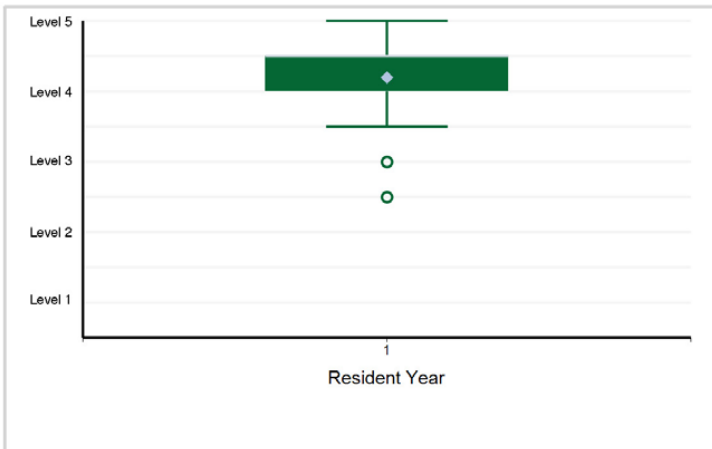

20. Professionalism - Professionalism 3: Self-Awareness and Help-Seeking

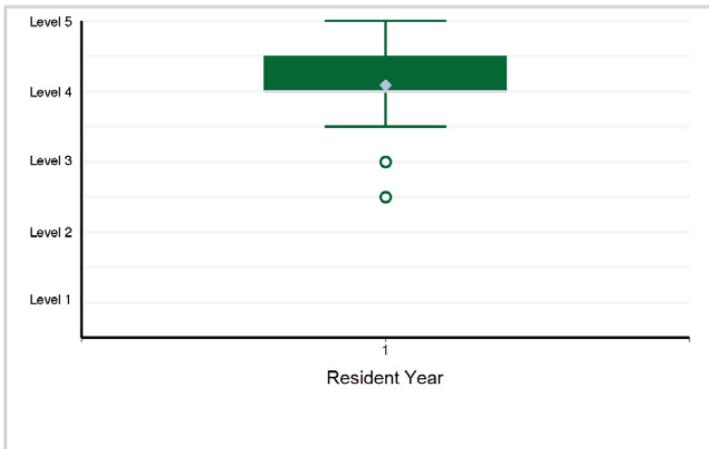

21. Interpersonal and Communication Skills - Interpersonal and Communication Skills 1: Patient- and Family-Centered Communication

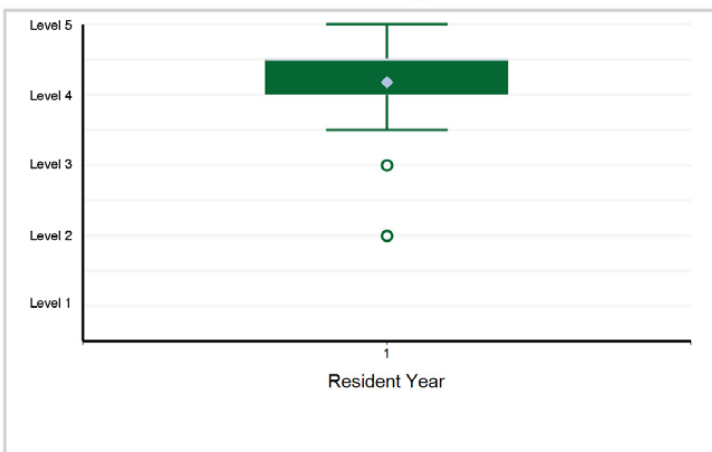

22. Interpersonal and Communication Skills - Interpersonal and Communication Skills 2: Interprofessional and Team Communication

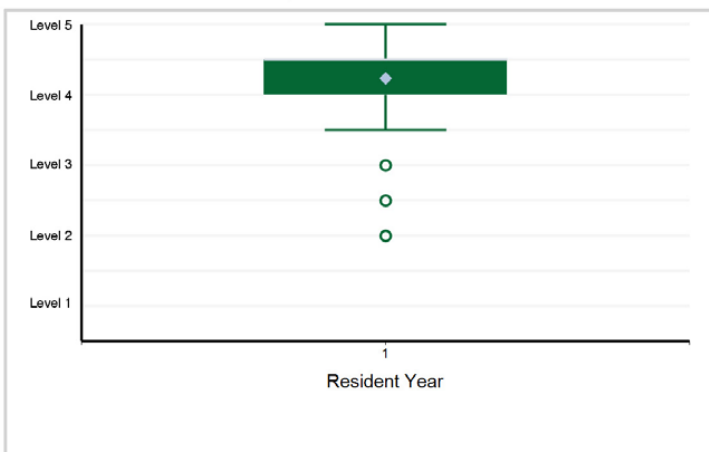

23. Interpersonal and Communication Skills - Interpersonal and Communication Skills 3: Communication within Health Care Systems

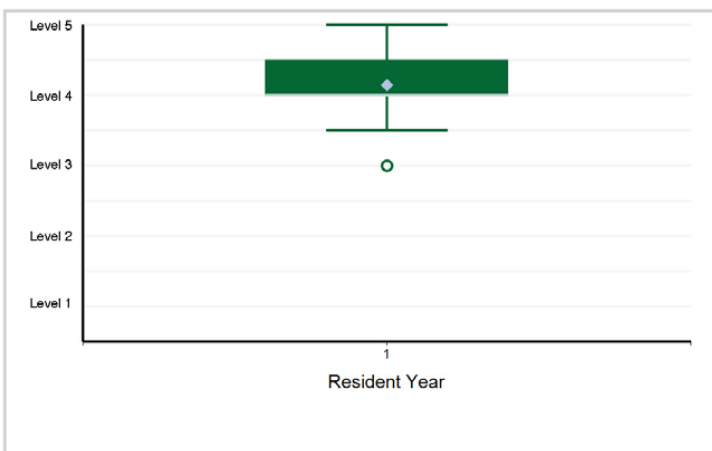

Specialty Box Plot Report - Milestone Evaluation by Resident Year: Year-End 2021-2022

TABLE 84: SUBSPECIALTY: **Clinical Informatics (multidisciplinary, Pathology)**

Resident Year	1	2	Total Residents
# of Residents	13	8	21

1. Patient Care - Patient Care 1: Technology Assessment

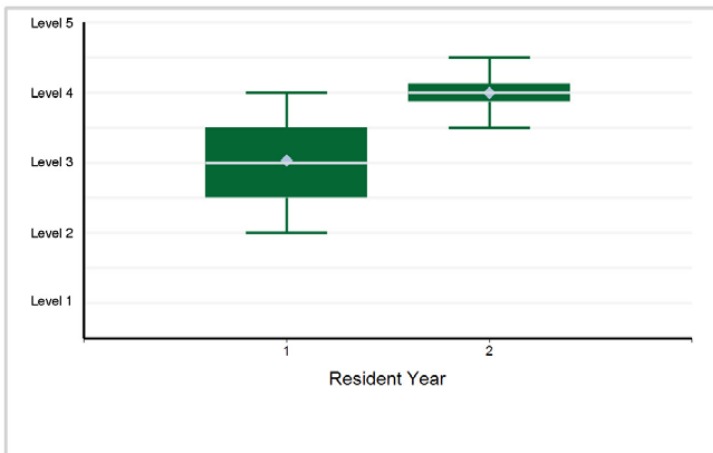

2. Patient Care - Patient Care 2: Clinical Decision Support Systems

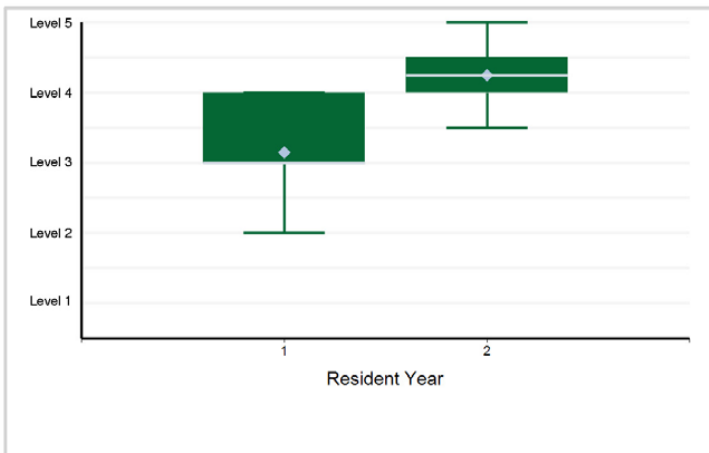

3. Patient Care - Patient Care 3: Impact of Clinical Informatics on Patient Care

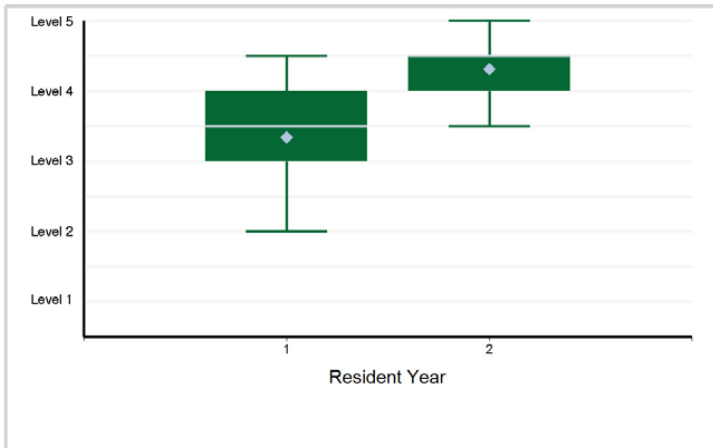

4. Patient Care - Patient Care 4: Project Management

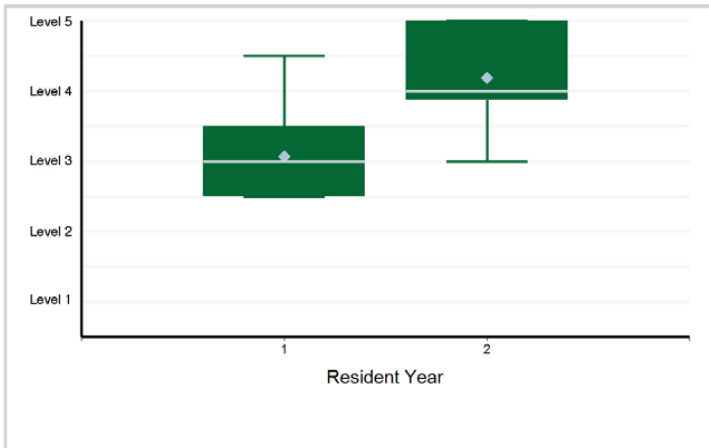

5. Patient Care - Patient Care 5: Information System Lifecycle

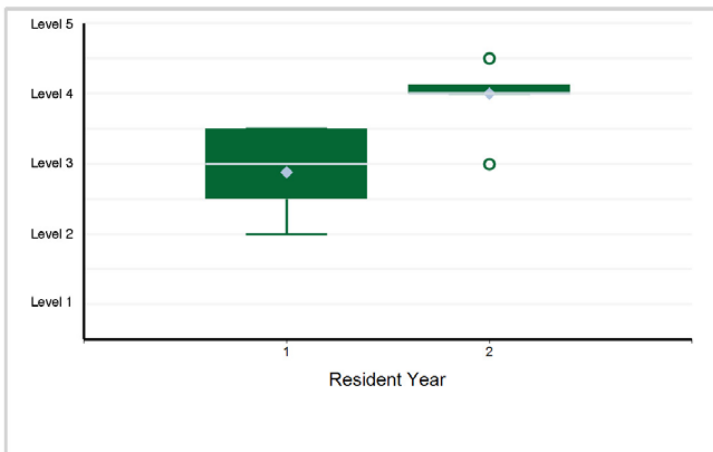

6. Patient Care - Patient Care 6: Assessing User Needs

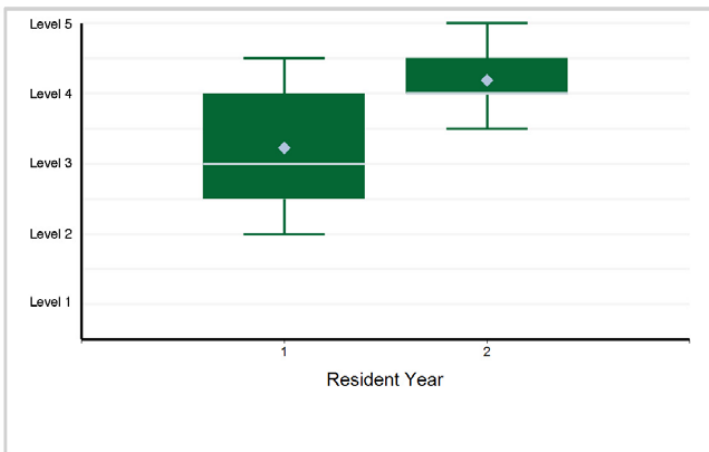

Specialty Box Plot Report - Milestone Evaluation by Resident Year: Year-End 2021-2022

SUBSPECIALTY: Clinical Informatics (multidisciplinary, Pathology)

7. Medical Knowledge - Medical Knowledge 1: Clinical Informatics Fundamentals and Programming

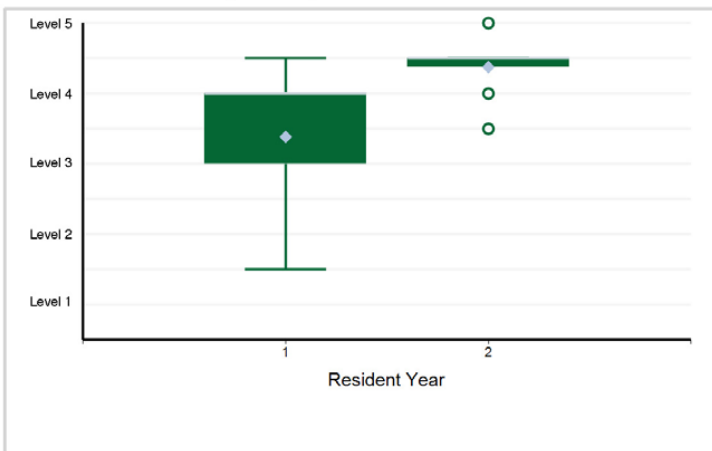

8. Medical Knowledge - Medical Knowledge 2: Leadership and Change Management

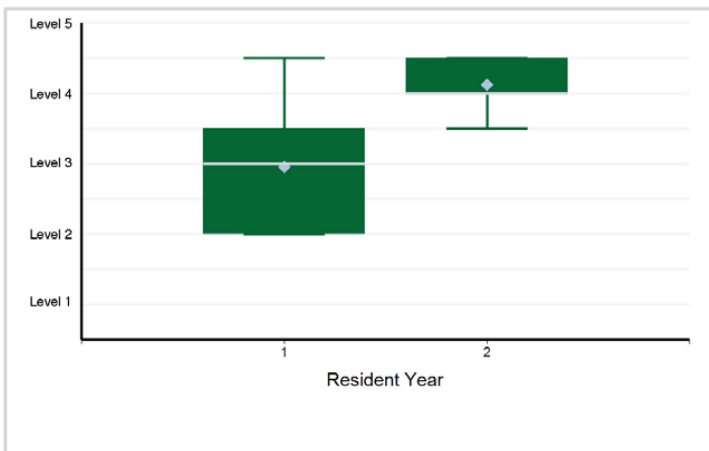

9. Systems-Based Practice - Systems-Based Practice 1: Patient Safety and Unintended Consequences

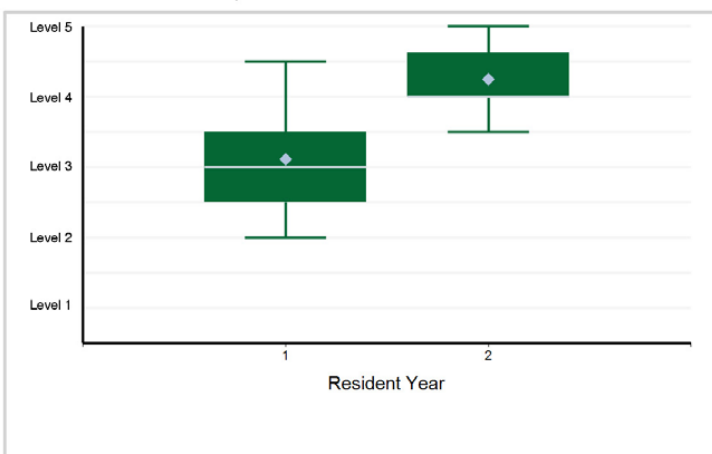

10. Systems-Based Practice - Systems-Based Practice 2: Resource Utilization

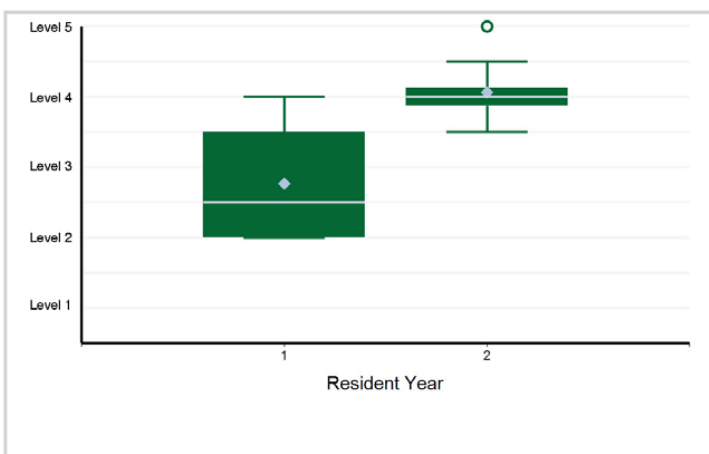

11. Systems-Based Practice - Systems-Based Practice 3: Workflow and Data Warehouse/Repository

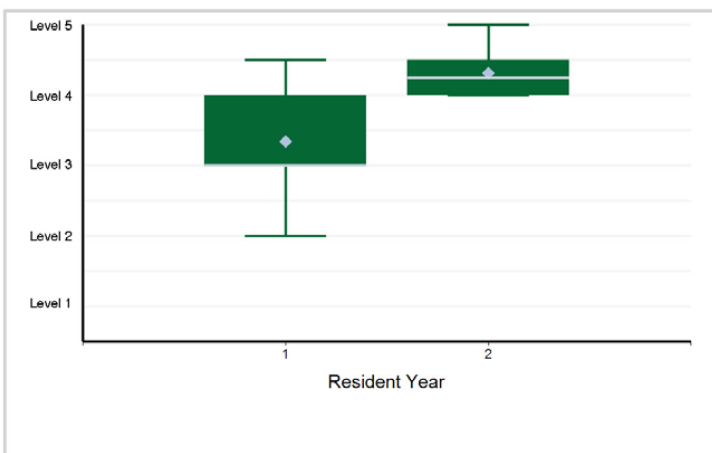

12. Practice-Based Learning and Improvement - Practice-Based Learning and Improvement 1: Recognition of ...

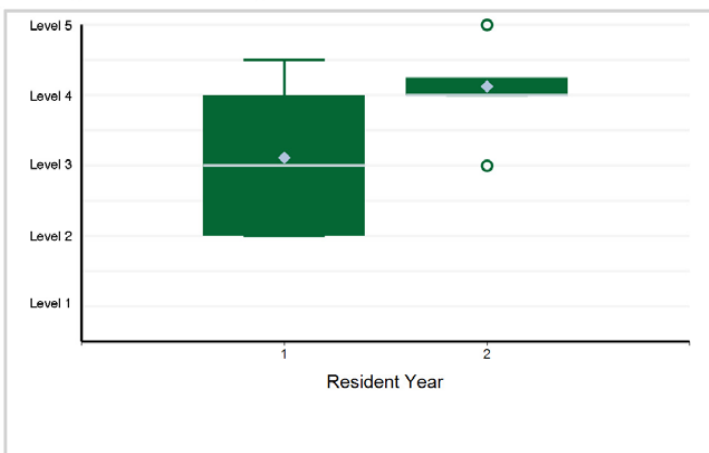

Specialty Box Plot Report - Milestone Evaluation by Resident Year: Year-End 2021-2022

SUBSPECIALTY: Clinical Informatics (multidisciplinary, Pathology)

13. Practice-Based Learning and Improvement - Practice-Based Learning and Improvement 2: Scholarly Activity ...

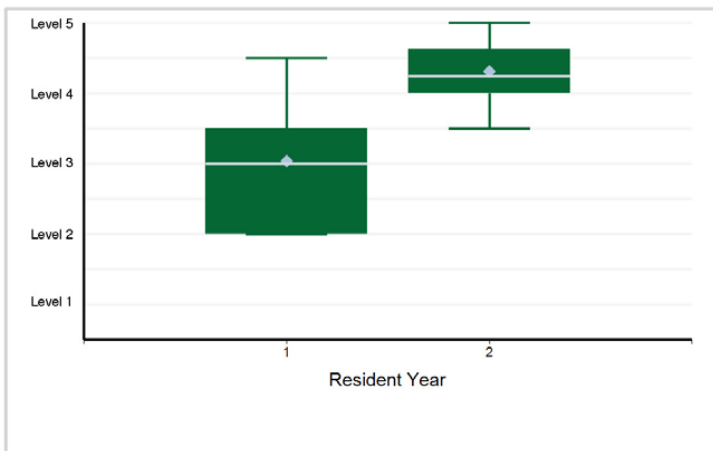

14. Professionalism - Professionalism 1: Professionalism — Demonstrates honesty, integrity, and ethical behavior

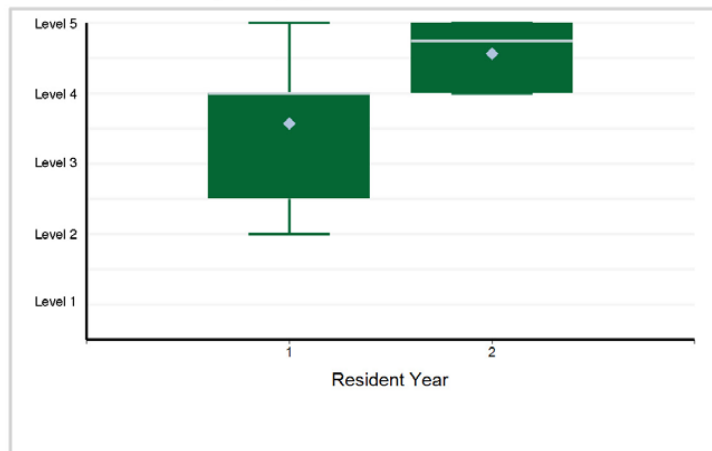

15. Professionalism - Professionalism 2: Professionalism — Demonstrates responsibility and follow-through on tasks

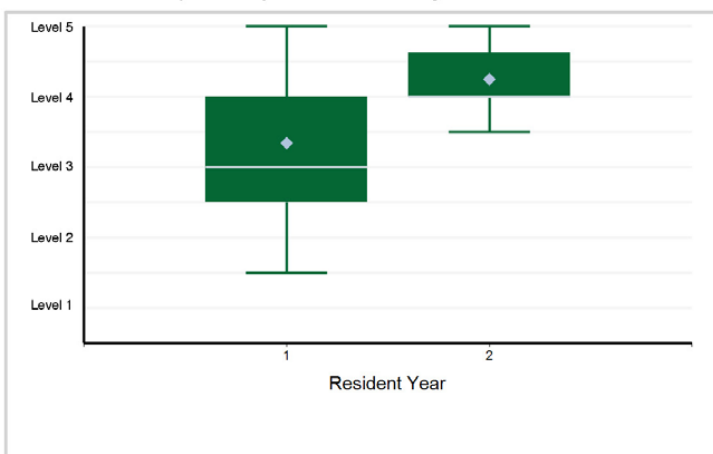

16. Professionalism - Professionalism 3: Professionalism — Gives and receives feedback

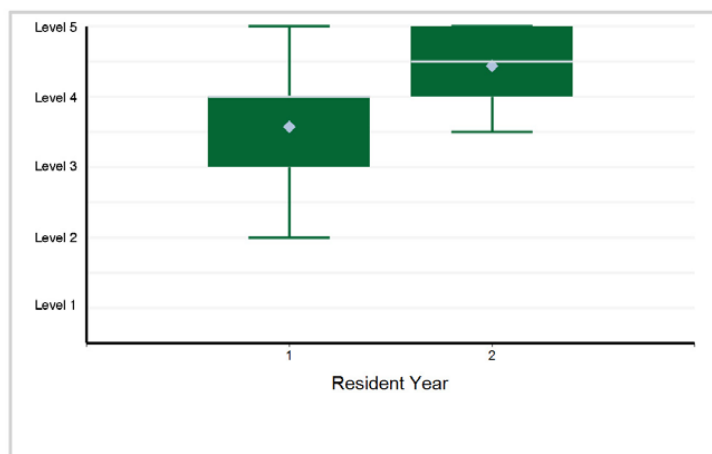

17. Professionalism - Professionalism 4: Professionalism — Demonstrates responsiveness and sensitivity to ...

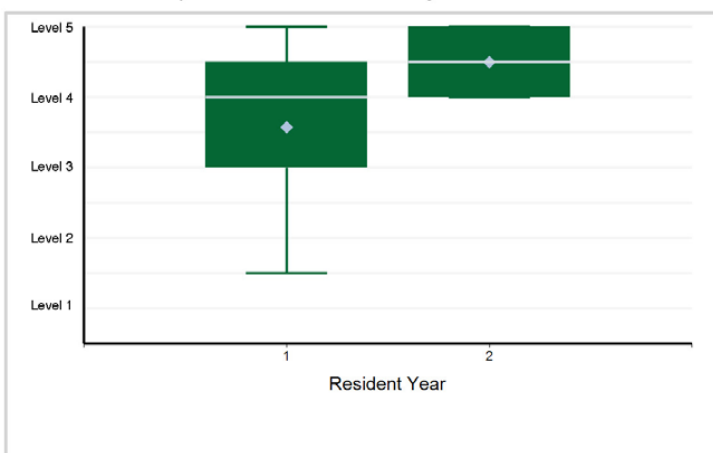

18. Professionalism - Professionalism 5: Professionalism — Understands and practices information security and privacy

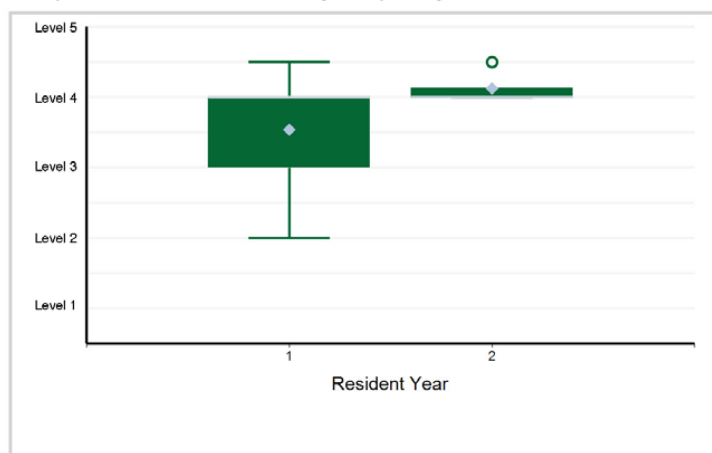

Specialty Box Plot Report - Milestone Evaluation by Resident Year: Year-End 2021-2022

SUBSPECIALTY: Clinical Informatics (multidisciplinary, Pathology)

19. Interpersonal and Communication Skills - Interpersonal and Communication Skills 1: Effective Communications ...

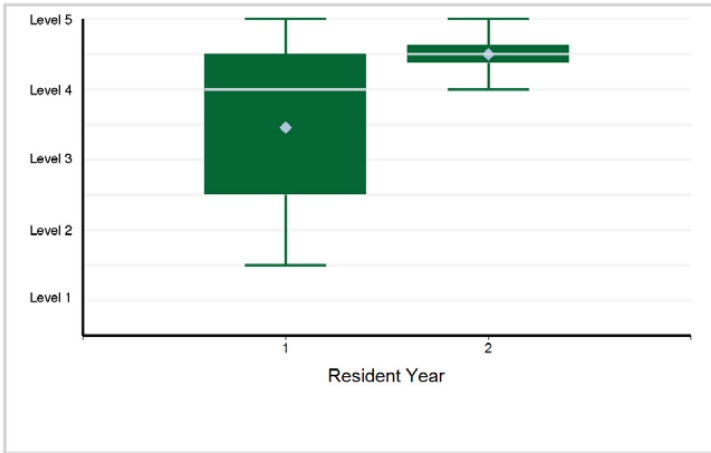

20. Interpersonal and Communication Skills - Interpersonal and Communication Skills 2: Communication with Patients and Families

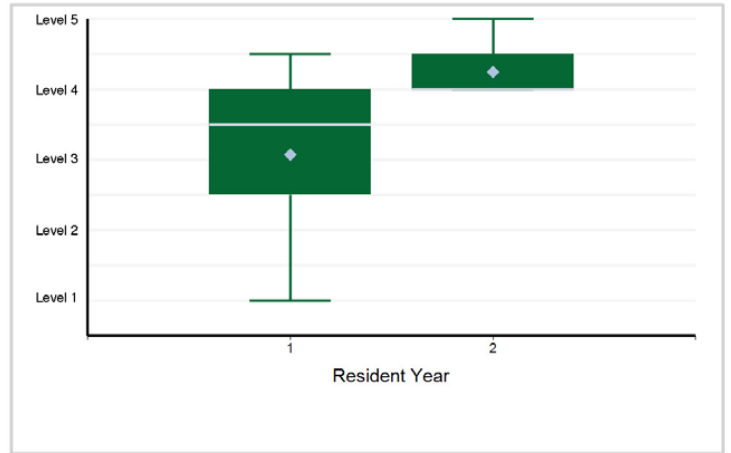

Specialty Box Plot Report - Milestone Evaluation by Resident Year: Year-End 2021-2022

TABLE 85: SUBSPECIALTY: **Cytopathology**

Resident Year	1	Total Residents
# of Residents	124	124

1. Patient Care - Patient Care 1: Reporting

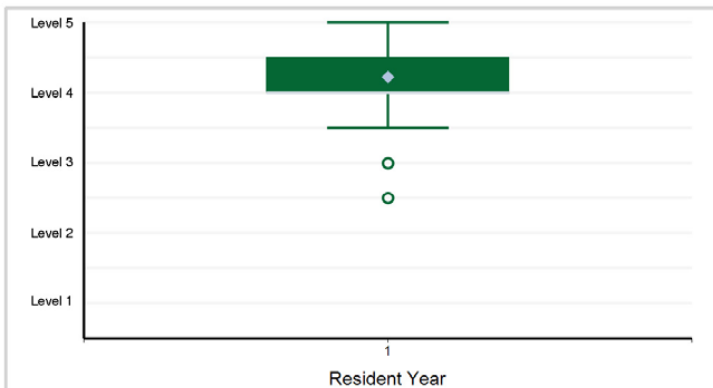

Note: 1 of 124 residents have a status of "Not Yet Rotated" and are not included in the analysis.

2. Patient Care - Patient Care 2: Consultation

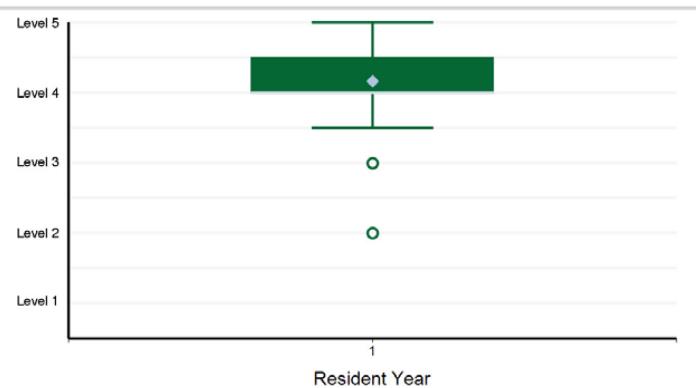

Note: 1 of 124 residents have a status of "Not Yet Rotated" and are not included in the analysis.

3. Patient Care - Patient Care 3: Performance of Fine Needle Aspirations

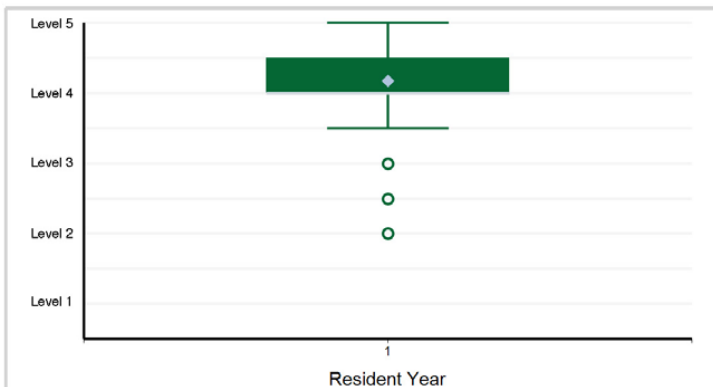

Note: 2 of 124 residents have a status of "Not Yet Rotated" and are not included in the analysis.

4. Patient Care - Patient Care 4: Adequacy (Rapid On-Site Evaluation [ROSE]) and Triage

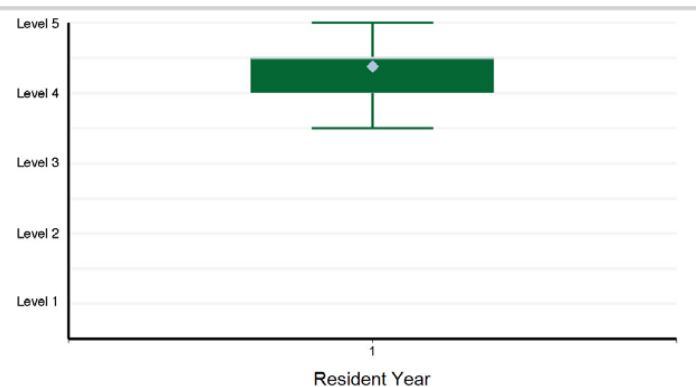

Note: 1 of 124 residents have a status of "Not Yet Rotated" and are not included in the analysis.

5. Patient Care - Patient Care 5: Fine Needle Aspiration Slide and Core Biopsy Touch Preparations

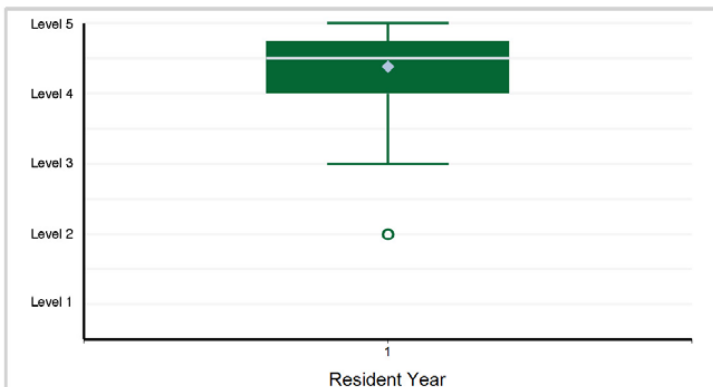

Note: 1 of 124 residents have a status of "Not Yet Rotated" and are not included in the analysis.

6. Patient Care - Patient Care 6: Cytopreparatory Techniques

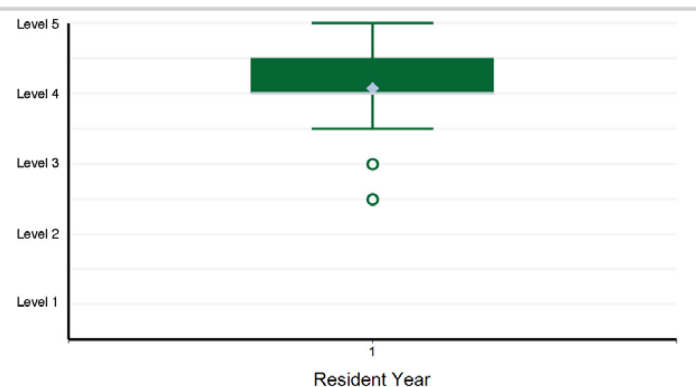

Note: 1 of 124 residents have a status of "Not Yet Rotated" and are not included in the analysis.

Specialty Box Plot Report - Milestone Evaluation by Resident Year: Year-End 2021-2022

SUBSPECIALTY: **Cytopathology**

7. Medical Knowledge - Medical Knowledge 1: Diagnosis

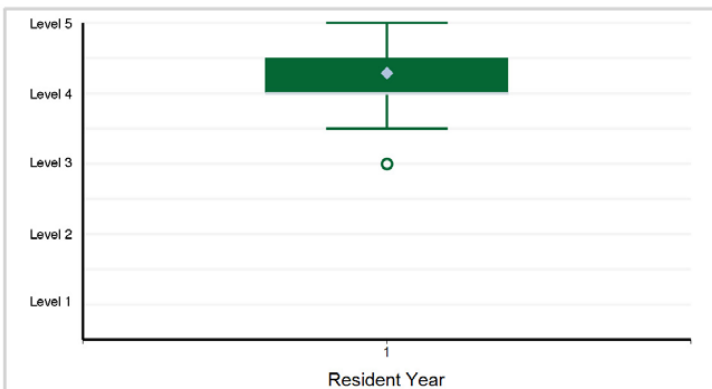

Note: 1 of 124 residents have a status of "Not Yet Rotated" and are not included in the analysis.

8. Medical Knowledge - Medical Knowledge 2: Clinical Reasoning

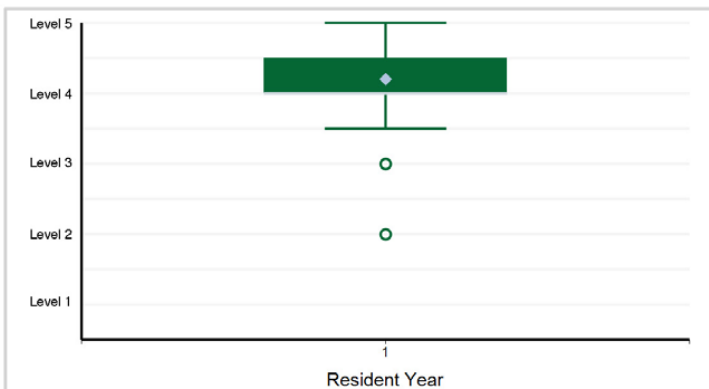

Note: 1 of 124 residents have a status of "Not Yet Rotated" and are not included in the analysis.

9. Systems-Based Practice - Systems-Based Practice 1: Patient Safety and Quality Improvement (QI)

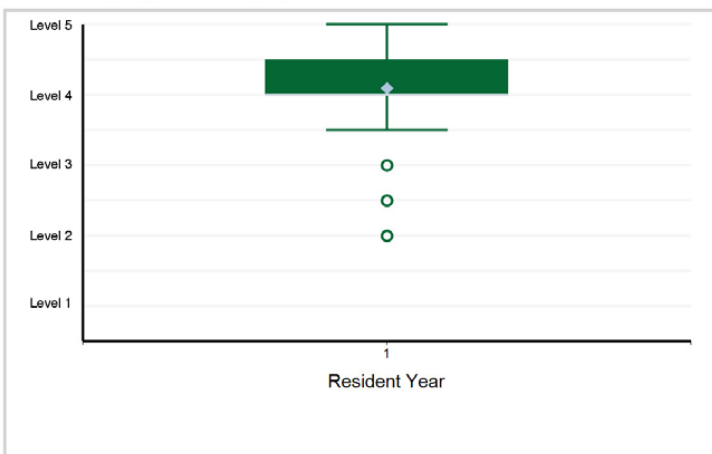

10. Systems-Based Practice - Systems-Based Practice 2: Systems Navigation for Patient-Centered Care

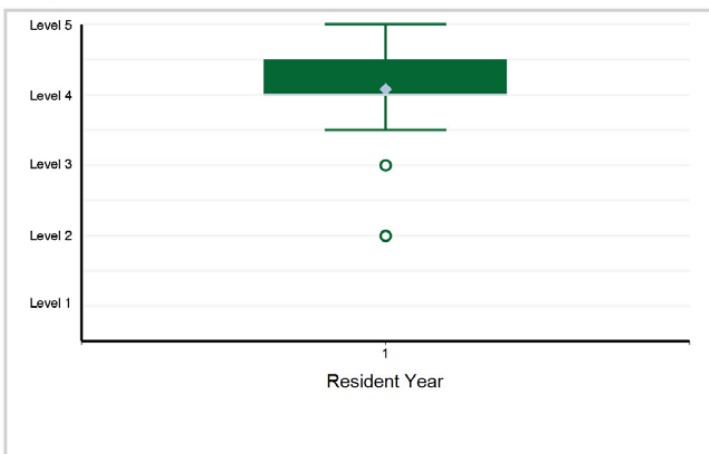

11. Systems-Based Practice - Systems-Based Practice 3: Physician Role in Health Care System



12. Systems-Based Practice - Systems-Based Practice 4: Accreditation, Compliance, and Quality



Specialty Box Plot Report - Milestone Evaluation by Resident Year: Year-End 2021-2022

SUBSPECIALTY: **Cytopathology**

13. - Systems-Based Practice 5: Utilization



14. Practice-Based Learning and Improvement - Practice-Based Learning and Improvement 1: Evidence-Based Practice and Scholarship

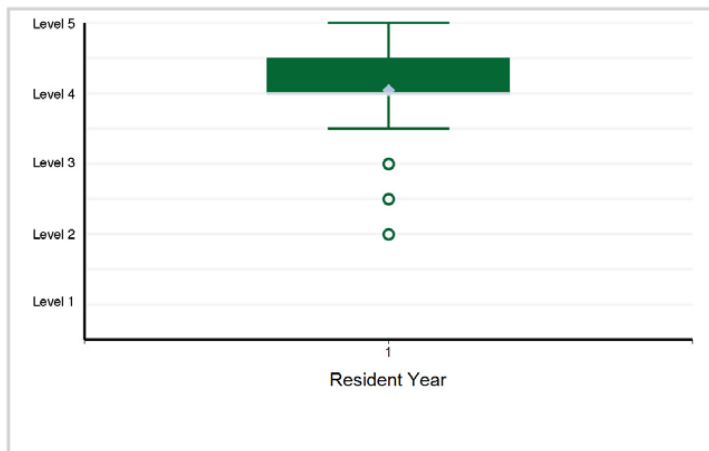

15. Practice-Based Learning and Improvement - Practice-Based Learning and Improvement 2: Reflective Practice and Commitment ...

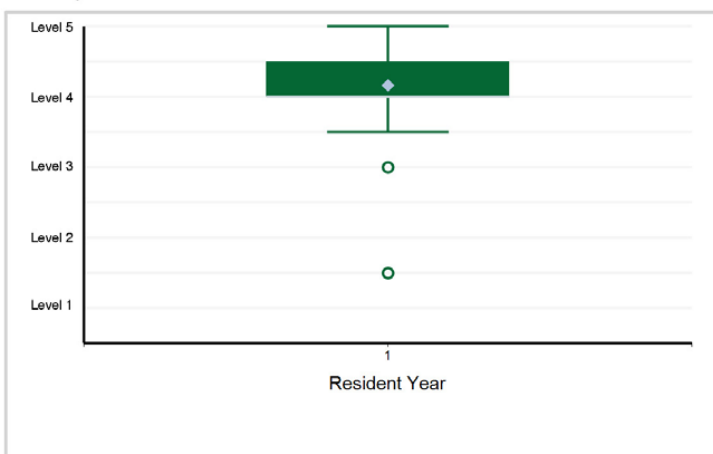

16. Professionalism - Professionalism 1: Professional Behavior and Ethical Principles

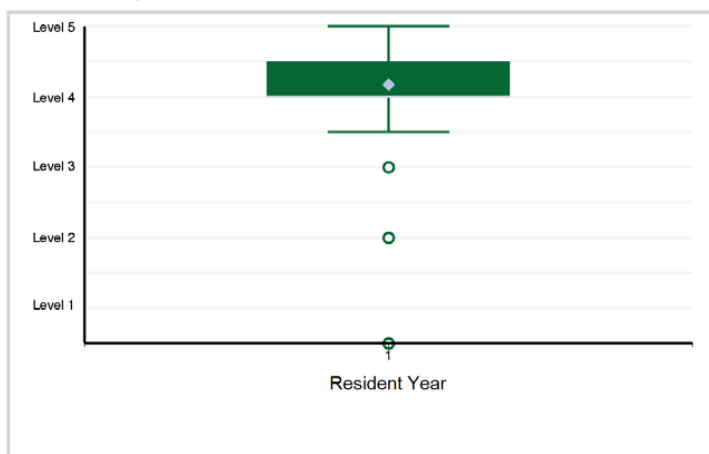

17. Professionalism - Professionalism 2: Accountability and Conscientiousness

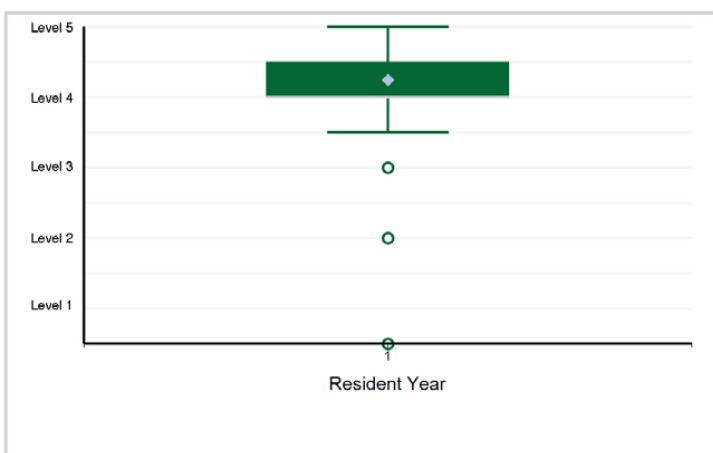

18. Professionalism - Professionalism 3: Self-Awareness and Help-Seeking

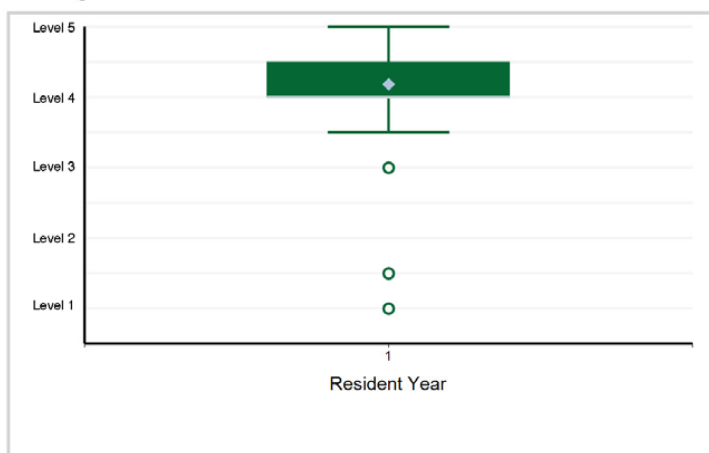

Specialty Box Plot Report - Milestone Evaluation by Resident Year: Year-End 2021-2022

SUBSPECIALTY: Cytopathology

19. Interpersonal and Communication Skills - Interpersonal and Communication Skills 1: Patient and Family-Centered Communication

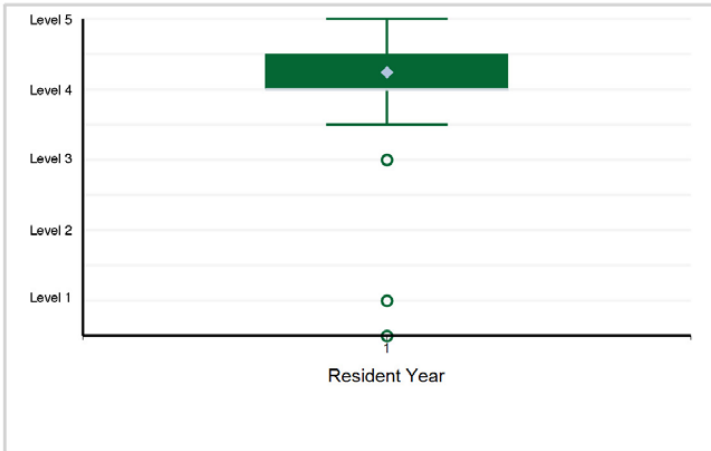

20. Interpersonal and Communication Skills - Interpersonal and Communication Skills 2: Interprofessional and Team Communication

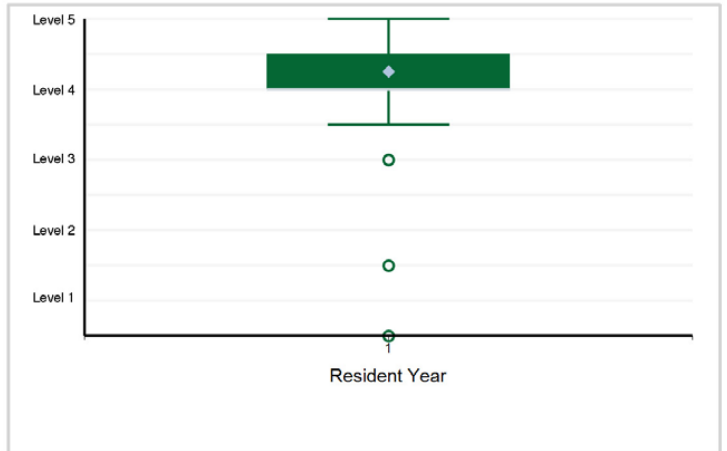

21. Interpersonal and Communication Skills - Interpersonal and Communication Skills 3: Communication within Health Care Systems

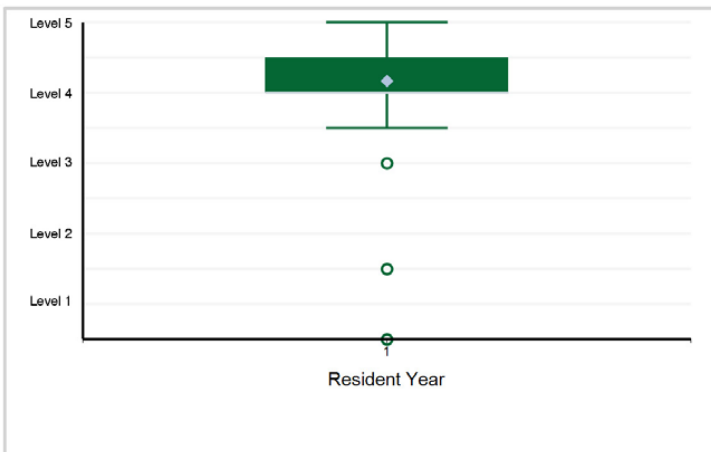

Specialty Box Plot Report - Milestone Evaluation by Resident Year: Year-End 2021-2022

TABLE 86: SUBSPECIALTY: **Forensic Pathology**

Resident Year	1	Total Residents
# of Residents	59	59

1. Patient Care - Patient Care 1: Death Investigation

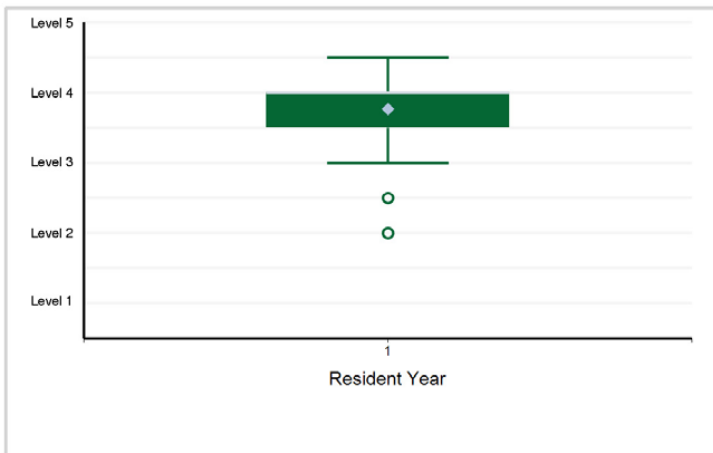

2. Patient Care - Patient Care 2: Autopsy (External and Internal Examination)

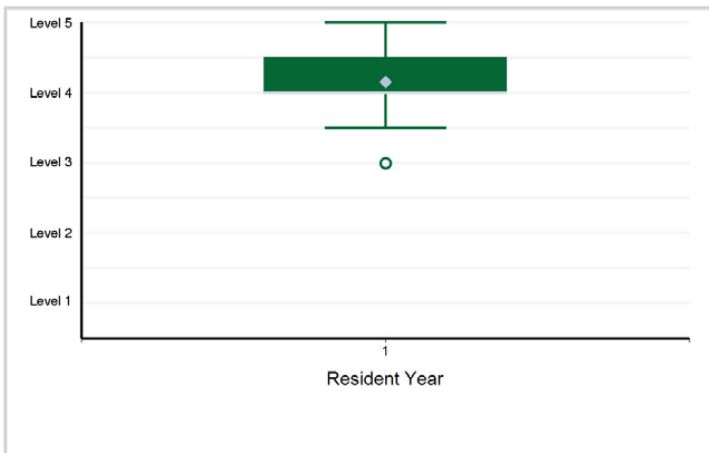

3. Medical Knowledge - Medical Knowledge 1: Death Certification and Reporting

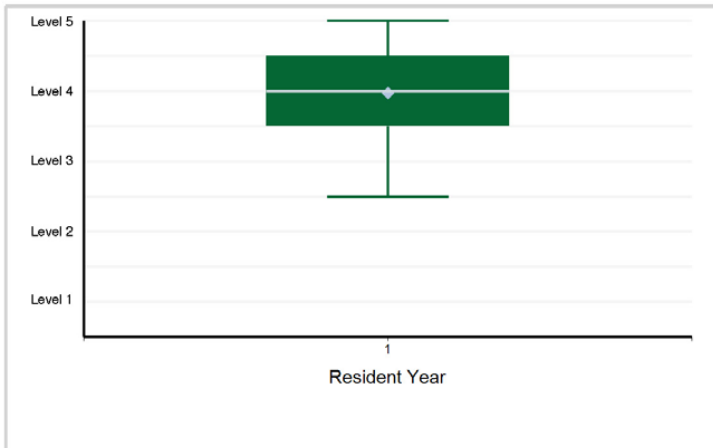

4. Medical Knowledge - Medical Knowledge 2: Recognition and Interpretation of Autopsy Findings and Ancillary Studies

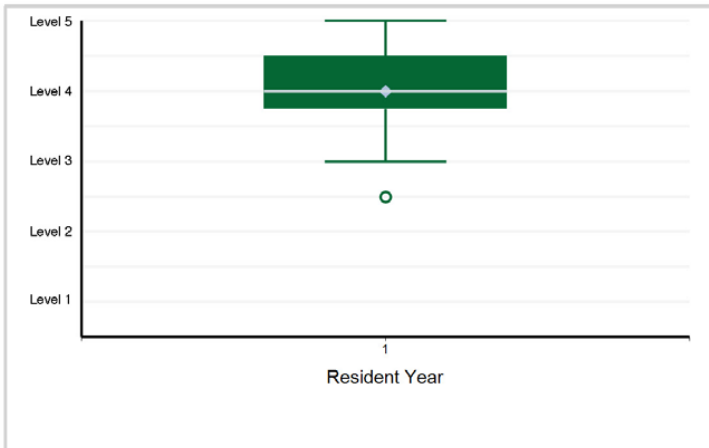

5. Medical Knowledge - Medical Knowledge 3: Clinical Reasoning

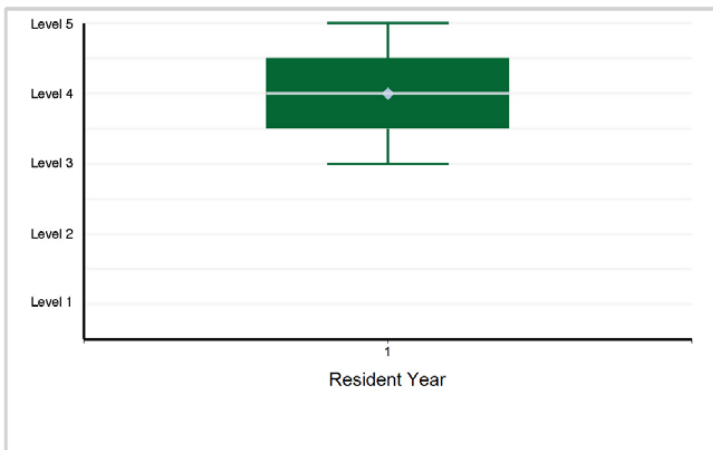

6. Systems-Based Practice - Systems-Based Practice 1: Safety and Quality Improvement (QI)

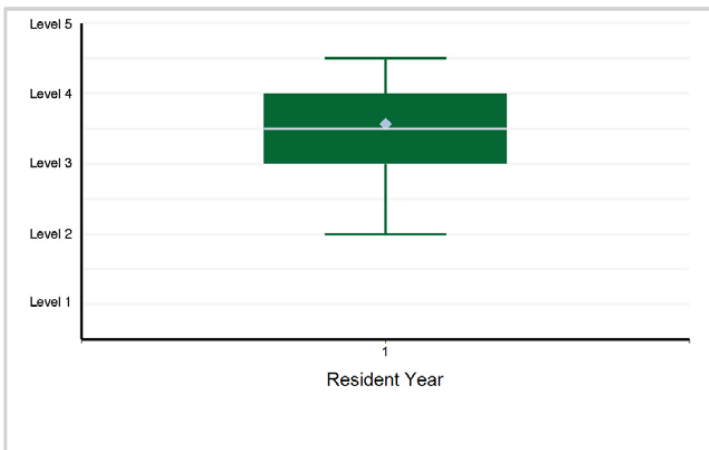

Specialty Box Plot Report - Milestone Evaluation by Resident Year: Year-End 2021-2022

SUBSPECIALTY: Forensic Pathology

7. Systems-Based Practice - Systems-Based Practice 2: Systems Navigation for Patient-Centered Care

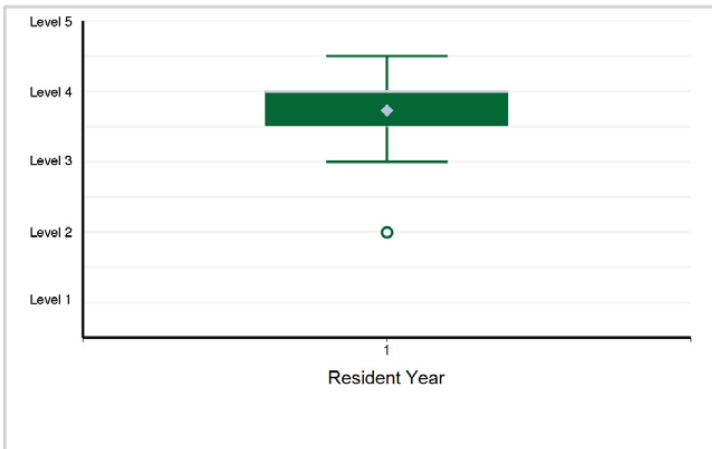

8. Systems-Based Practice - Systems-Based Practice 3: Physician Role in Health Care System



9. Systems-Based Practice - Systems-Based Practice 4: Accreditation, Compliance, and Quality

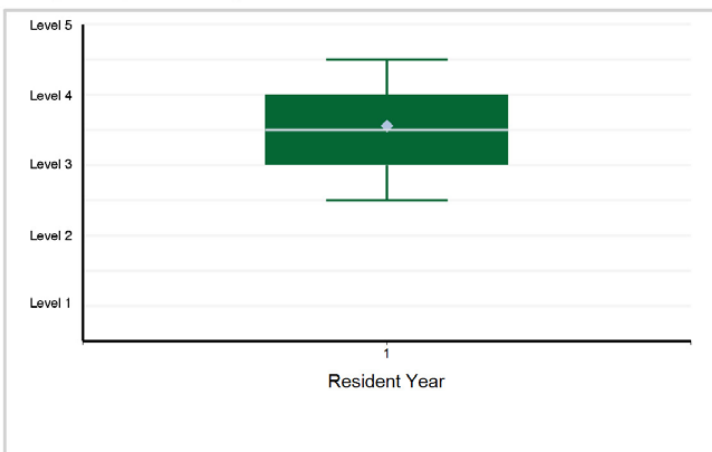

10. Systems-Based Practice - Systems-Based Practice 5: Utilization

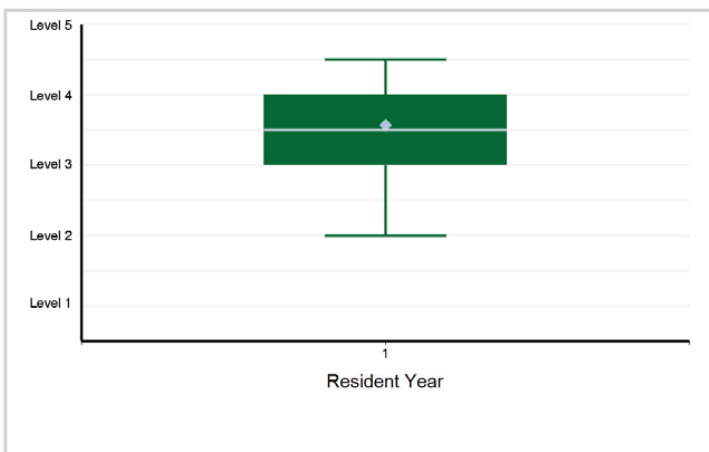

11. Practice-Based Learning and Improvement - Practice-Based Learning and Improvement 1: Evidence-Based Practice and Scholarship

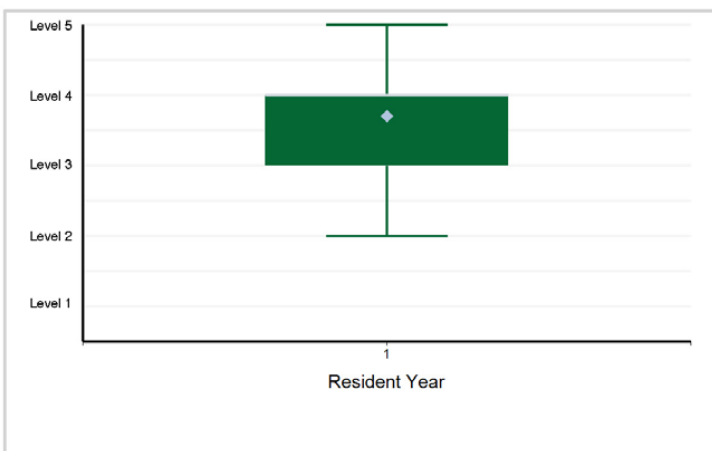

12. Practice-Based Learning and Improvement - Practice-Based Learning and Improvement 2: Reflective Practice and Commitment ...



Specialty Box Plot Report - Milestone Evaluation by Resident Year: Year-End 2021-2022

SUBSPECIALTY: Forensic Pathology

13. Professionalism - Professionalism 1: Professional Behavior and Ethical Principles

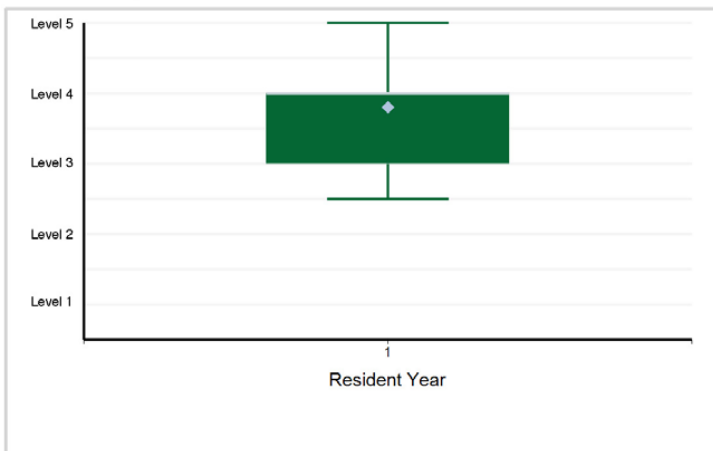

14. Professionalism - Professionalism 2: Accountability and Conscientiousness

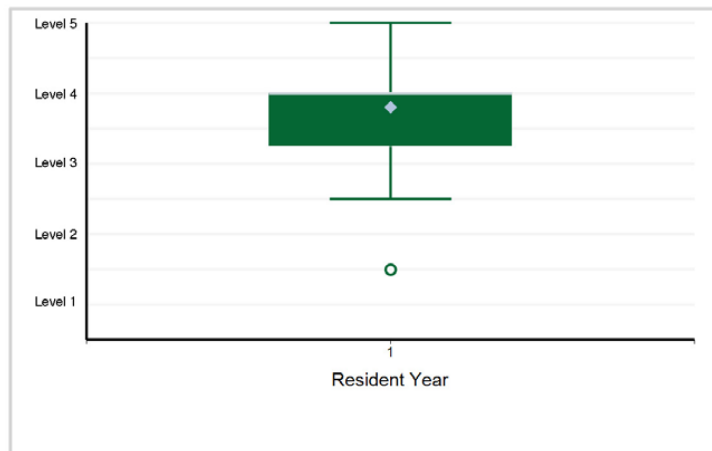

15. Professionalism - Professionalism 3: Self-Awareness and Help-Seeking

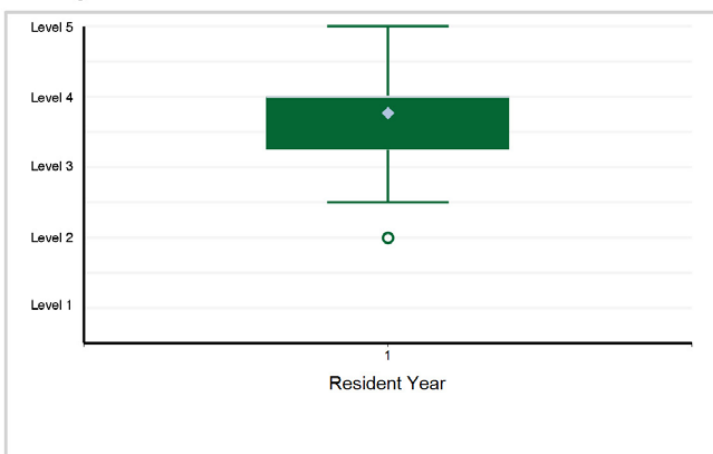

16. Interpersonal and Communication Skills - Interpersonal and Communication Skills 1: Family-Centered Communication



17. Interpersonal and Communication Skills - Interpersonal and Communication Skills 2: Interprofessional and Team Communication

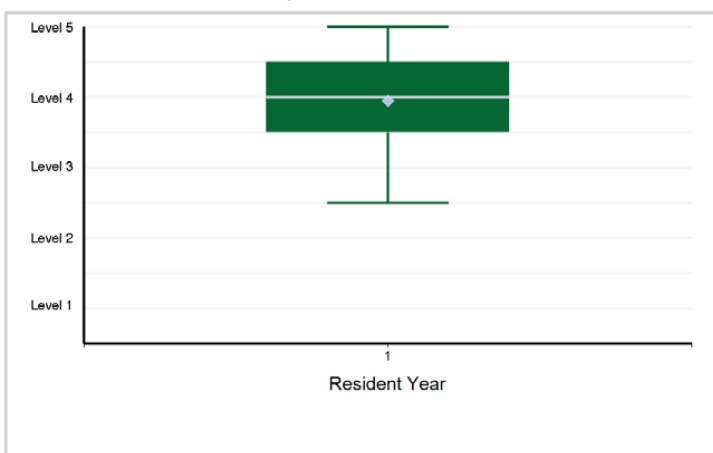

18. Interpersonal and Communication Skills - Interpersonal and Communication Skills 3: Systems Communication



Specialty Box Plot Report - Milestone Evaluation by Resident Year: Year-End 2021-2022

SUBSPECIALTY: **Forensic Pathology**

19. Interpersonal and Communication Skills - Interpersonal and Communication Skills 4: Medicolegal Communication



Specialty Box Plot Report - Milestone Evaluation by Resident Year: Year-End 2021-2022

TABLE 87: SUBSPECIALTY: **Hematopathology**

Resident Year	1	Total Residents
# of Residents	128	128

1. Patient Care - Patient Care 1: Interdisciplinary Consultation

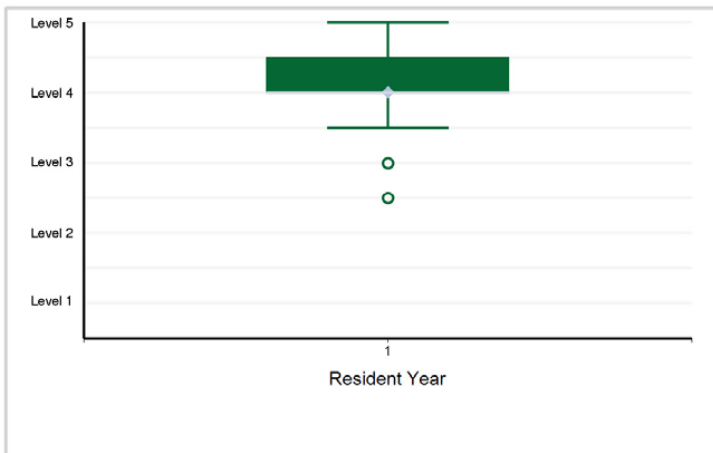

2. Patient Care - Patient Care 2: Reporting

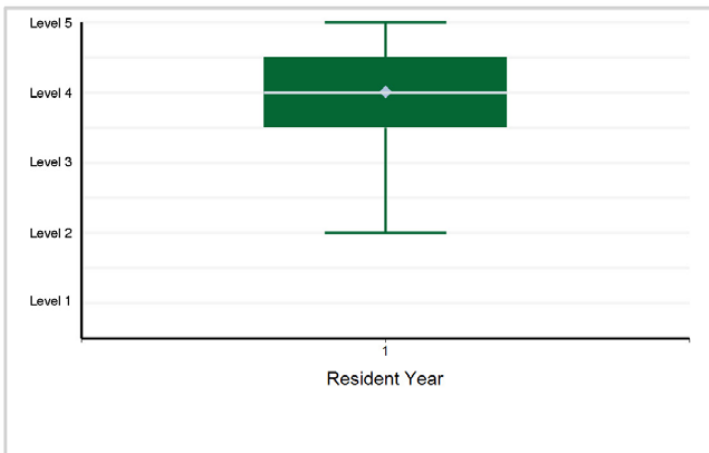

3. Patient Care - Patient Care 3: Procedure: Bone Marrow Aspiration and Biopsy

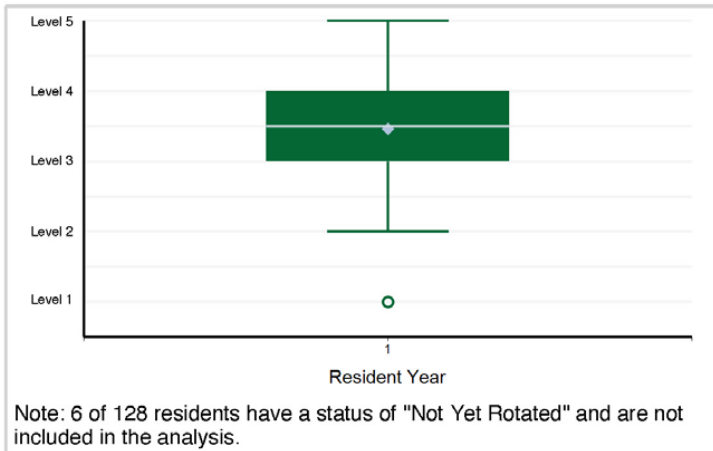

4. Patient Care - Patient Care 4: Specimen Handling and Triaging

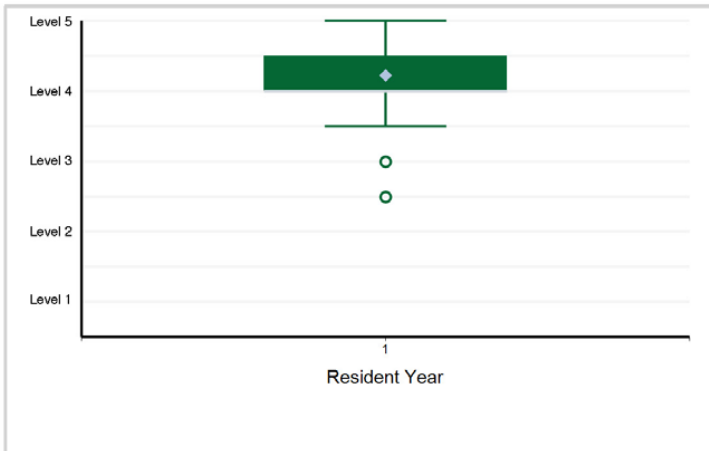

5. Medical Knowledge - Medical Knowledge 1: Interpretation of Hematology Testing

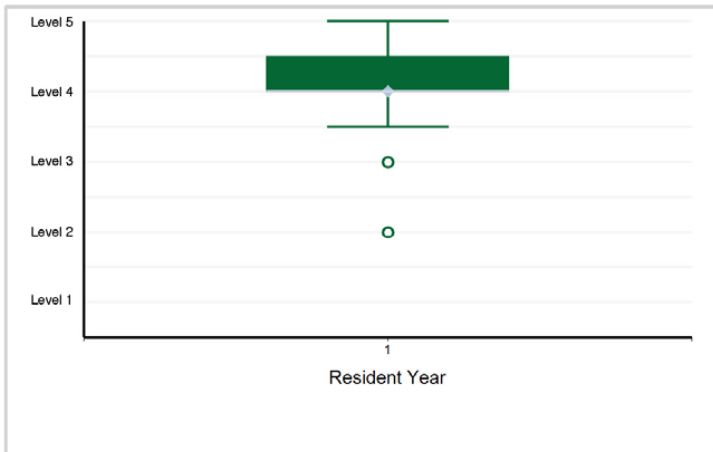

6. Medical Knowledge - Medical Knowledge 2: Interpretation of Coagulation Testing

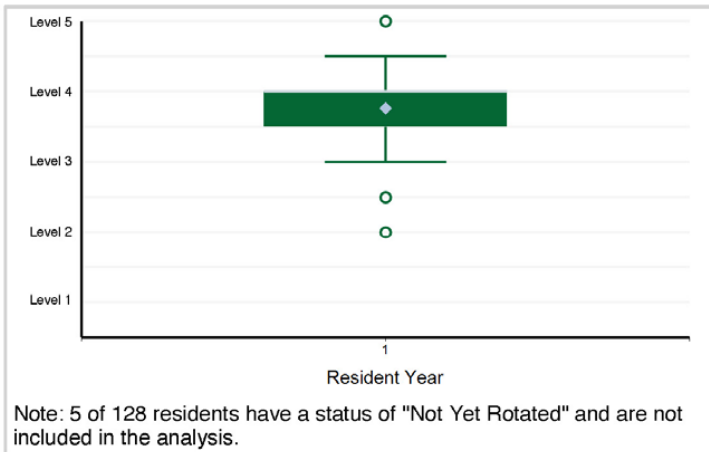

Specialty Box Plot Report - Milestone Evaluation by Resident Year: Year-End 2021-2022

SUBSPECIALTY: Hematopathology

7. Medical Knowledge - Medical Knowledge 3: Interpretation of Flow Cytometry

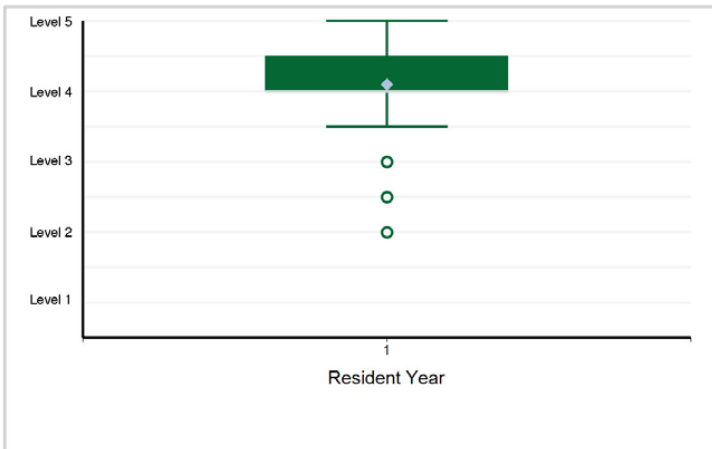

8. Medical Knowledge - Medical Knowledge 4: Morphologic Interpretation and Diagnosis

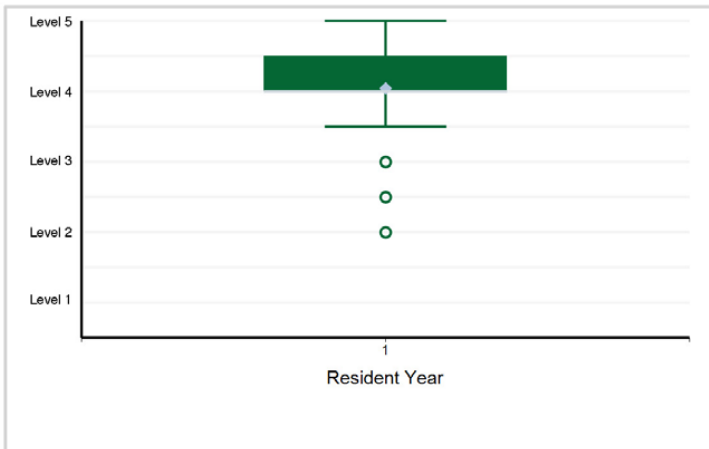

9. Medical Knowledge - Medical Knowledge 5: Selection of Molecular and Cytogenetics Testing and Interpretation of Reports



10. Medical Knowledge - Medical Knowledge 6: Clinical Reasoning in Hematopathology and Hematology

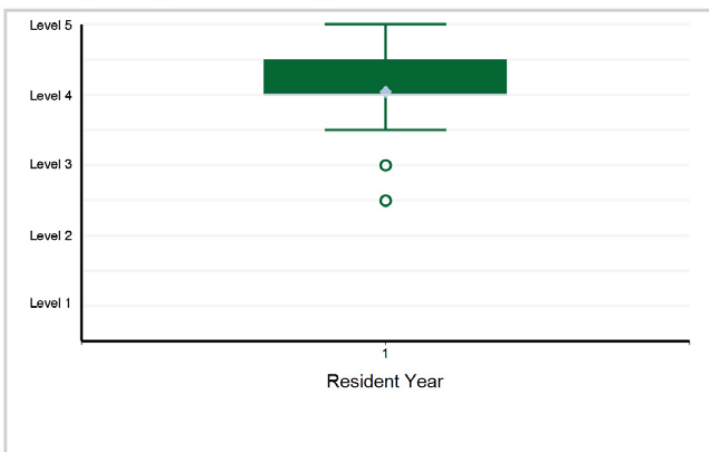

11. Systems-Based Practice - Systems-Based Practice 1: Patient Safety and Quality Improvement (QI)



12. Systems-Based Practice - Systems-Based Practice 2: Systems Navigation for Patient-Centered Care



Specialty Box Plot Report - Milestone Evaluation by Resident Year: Year-End 2021-2022

SUBSPECIALTY: Hematopathology

13. Systems-Based Practice - Systems-Based Practice 3: Physician Role in Health Care System



14. Systems-Based Practice - Systems-Based Practice 4: Accreditation, Compliance, and Quality

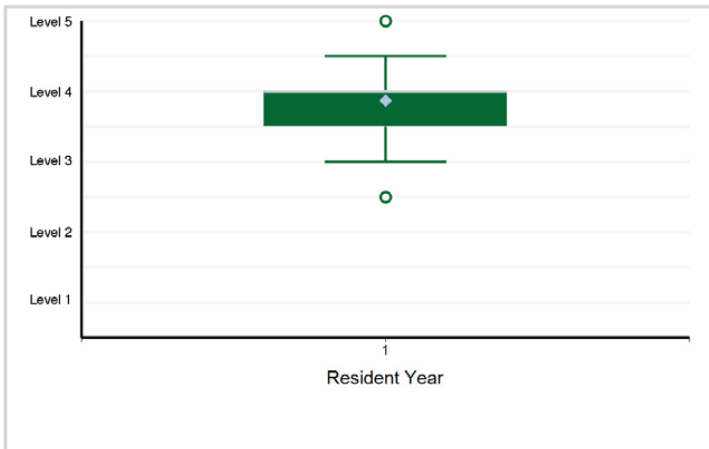

15. Systems-Based Practice - Systems-Based Practice 5: Utilization

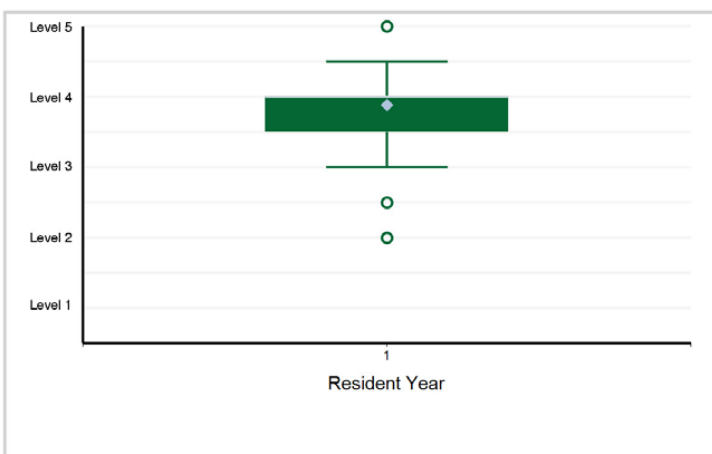

16. Practice-Based Learning and Improvement - Practice-Based Learning and Improvement 1: Evidence-Based Practice and Scholarship



17. Practice-Based Learning and Improvement - Practice-Based Learning and Improvement 2: Reflective Practice and Commitment ...

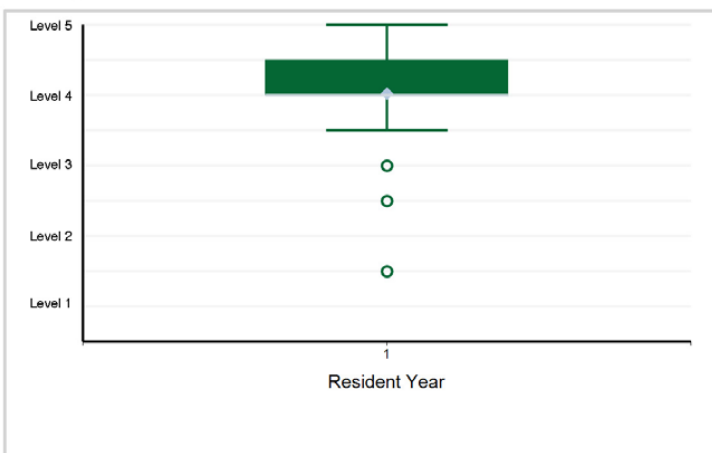

18. Professionalism - Professionalism 1: Professional Behavior and Ethical Principles

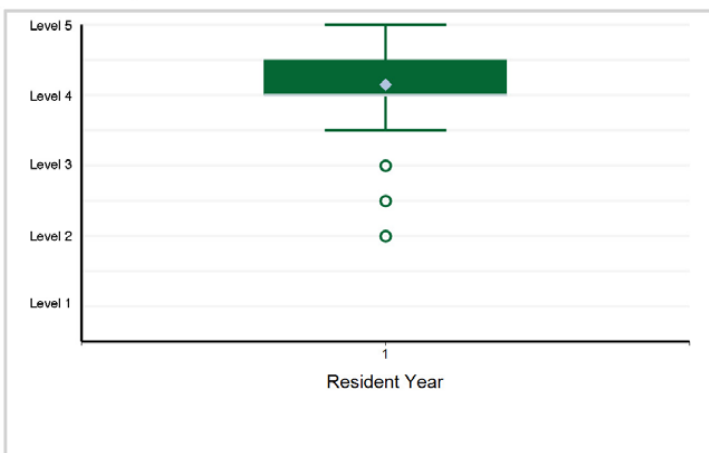

Specialty Box Plot Report - Milestone Evaluation by Resident Year: Year-End 2021-2022

SUBSPECIALTY: Hematopathology

19. Professionalism - Professionalism 2: Accountability and Conscientiousness

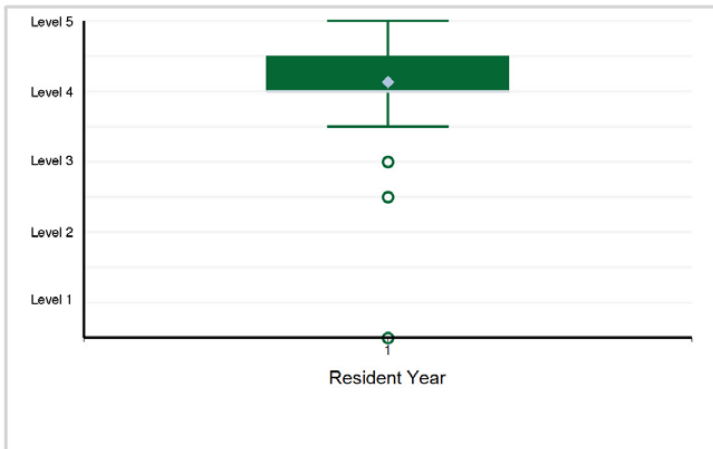

20. Professionalism - Professionalism 3: Self-Awareness and Help-Seeking

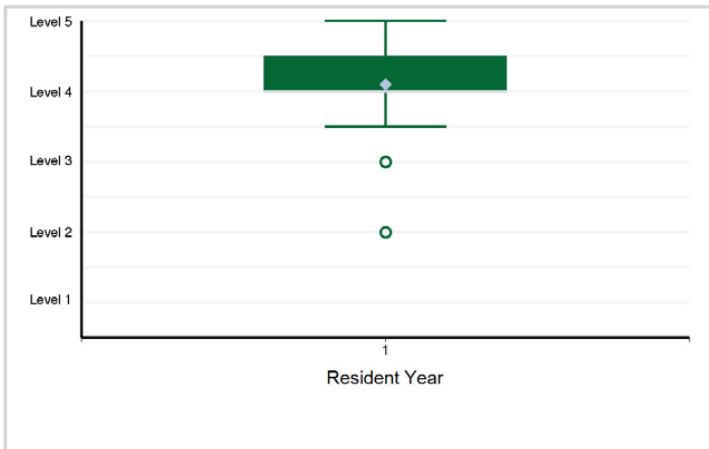

21. Interpersonal and Communication Skills - Interpersonal and Communication Skills 1: Patient- and Family-Centered Communication



22. Interpersonal and Communication Skills - Interpersonal and Communication Skills 2: Interprofessional and Team Communication

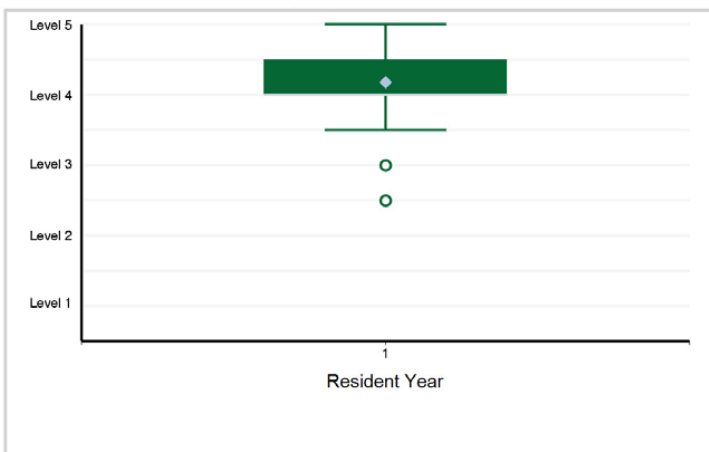

23. Interpersonal and Communication Skills - Interpersonal and Communication Skills 3: Communication within Health Care Systems

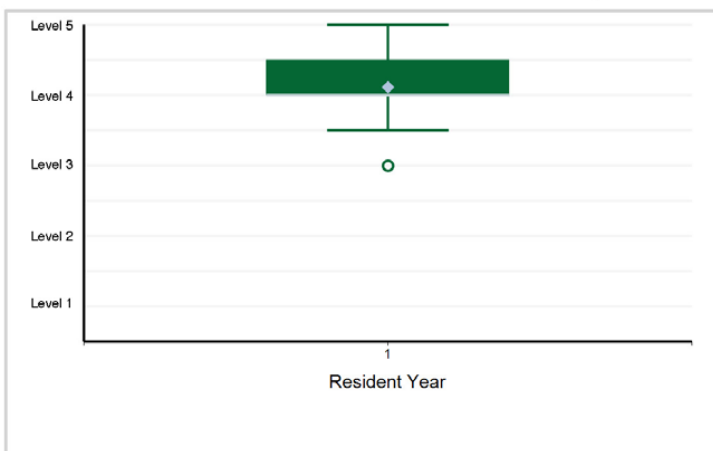

Specialty Box Plot Report - Milestone Evaluation by Resident Year: Year-End 2021-2022

TABLE 88: SUBSPECIALTY: **Medical Microbiology**

Resident Year	1	Total Residents
# of Residents	12	12

1. Patient Care - Patient Care 1: Clinical Consultation

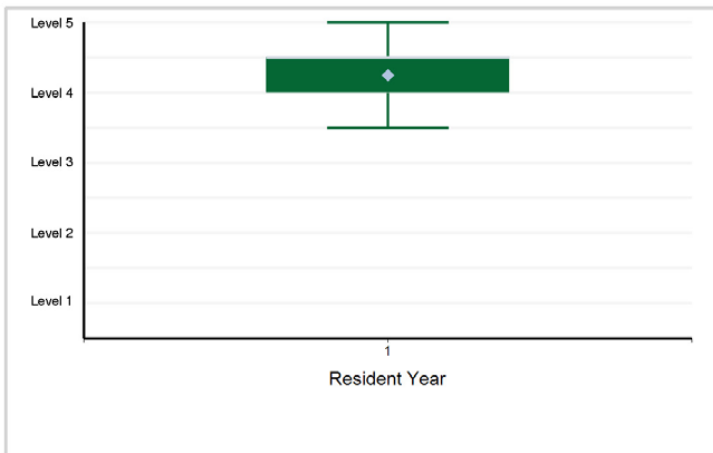

2. Patient Care - Patient Care 2: Test Performance and Organism Identification

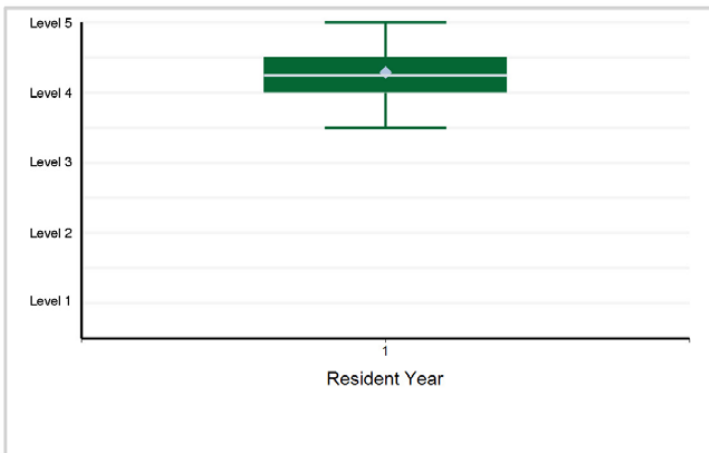

3. Patient Care - Patient Care 3: Test Interpretation and Reporting

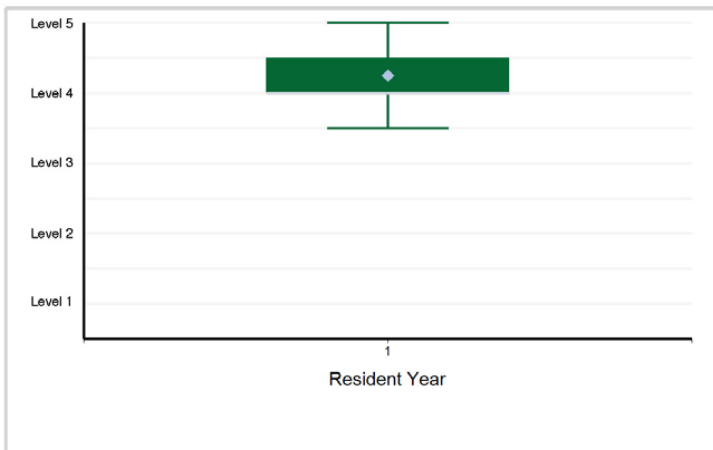

4. Medical Knowledge - Medical Knowledge 1: Fundamental and Diagnostic Knowledge

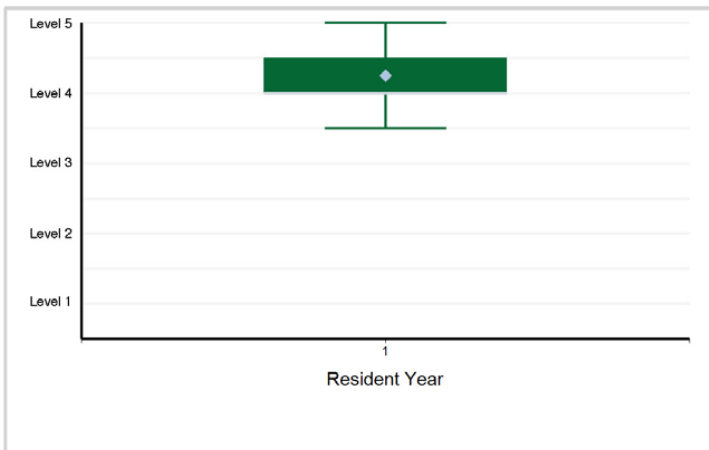

5. Medical Knowledge - Medical Knowledge 2: Test Methodology

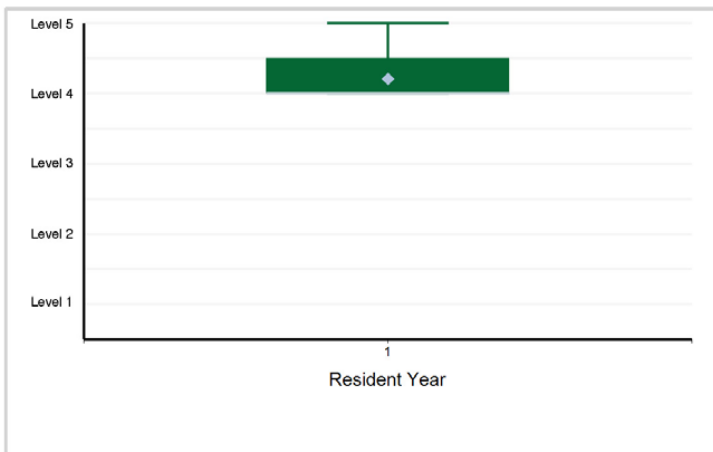

6. Medical Knowledge - Medical Knowledge 3: Test Development and Validation/Verification



Specialty Box Plot Report - Milestone Evaluation by Resident Year: Year-End 2021-2022

SUBSPECIALTY: Medical Microbiology

7. Medical Knowledge - Medical Knowledge 4: Clinical Reasoning

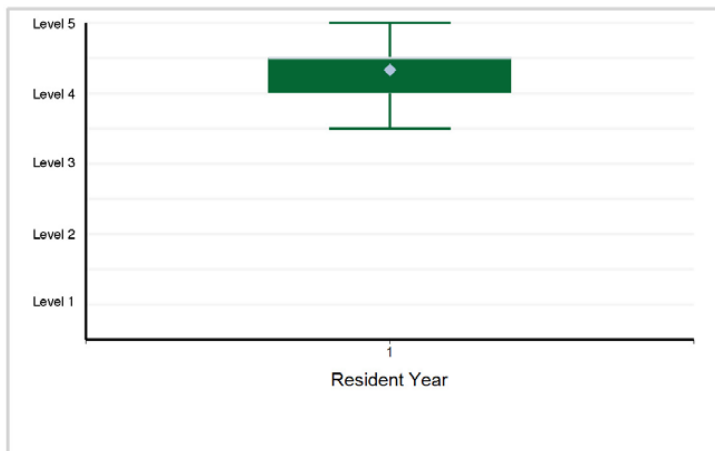

8. Systems-Based Practice - Systems-Based Practice 1: Patient Safety and Quality Improvement (QI)

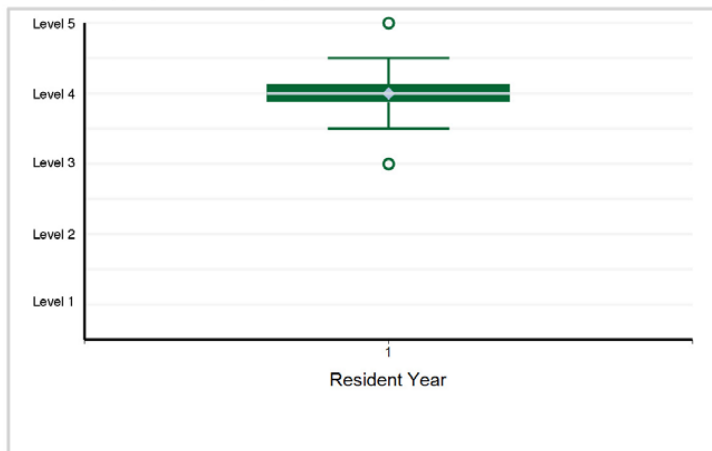

9. Systems-Based Practice - Systems-Based Practice 2: Systems Navigation for Patient-Centered Care

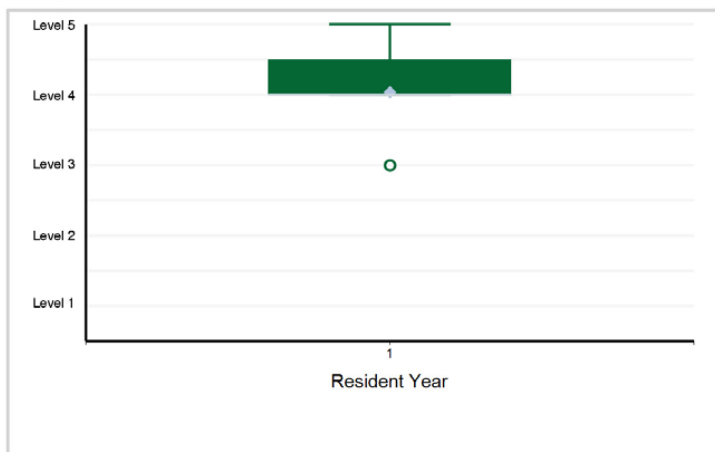

10. Systems-Based Practice - Systems-Based Practice 3: Physician Role in Health Care System

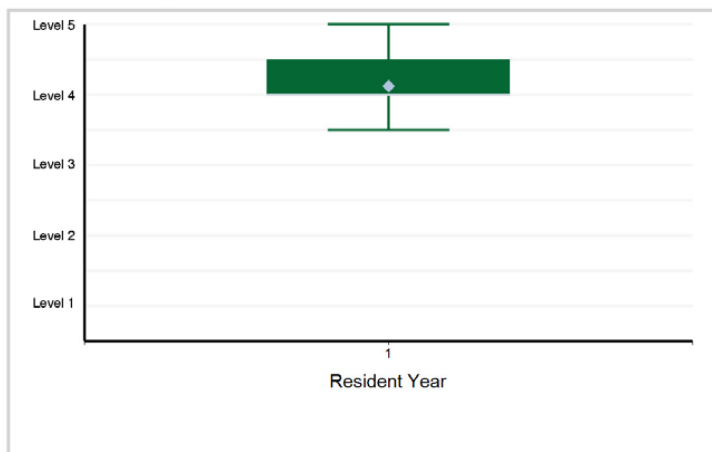

11. Systems-Based Practice - Systems-Based Practice 4: Accreditation, Compliance, and Quality

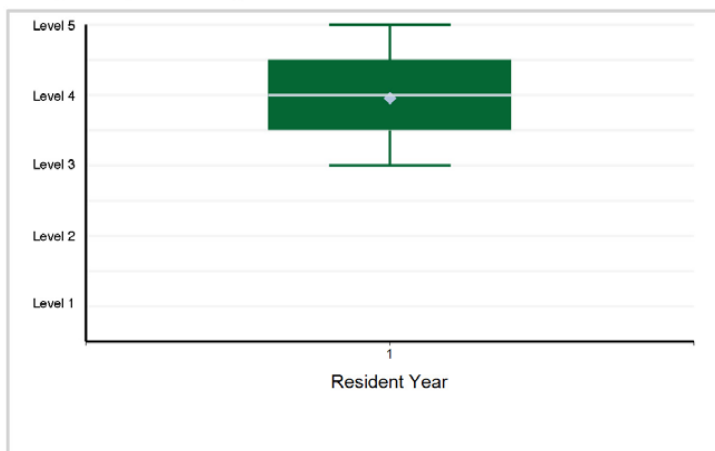

12. Systems-Based Practice - Systems-Based Practice 5: Utilization

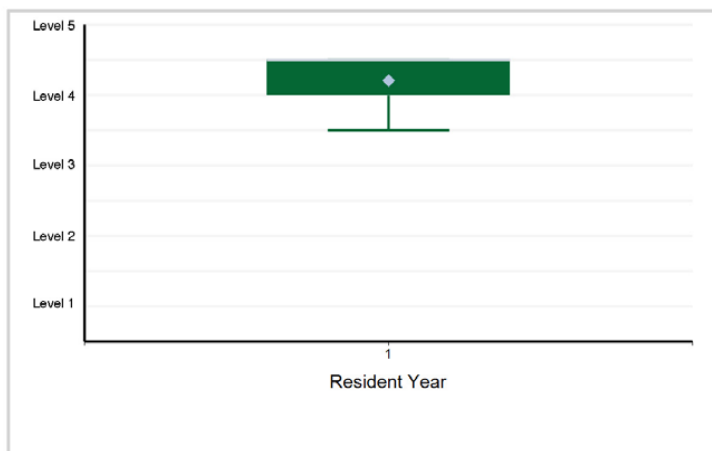

Specialty Box Plot Report - Milestone Evaluation by Resident Year: Year-End 2021-2022

SUBSPECIALTY: Medical Microbiology

13. Systems-Based Practice - Systems-Based Practice 6: Infection Prevention, Antimicrobial Stewardship, and Public Health

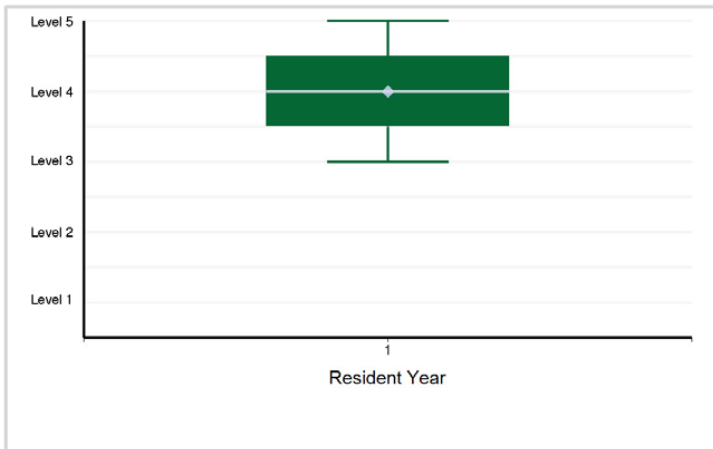

14. Practice-Based Learning and Improvement - Practice-Based Learning and Improvement 1: Evidence-Based Practice and Scholarship

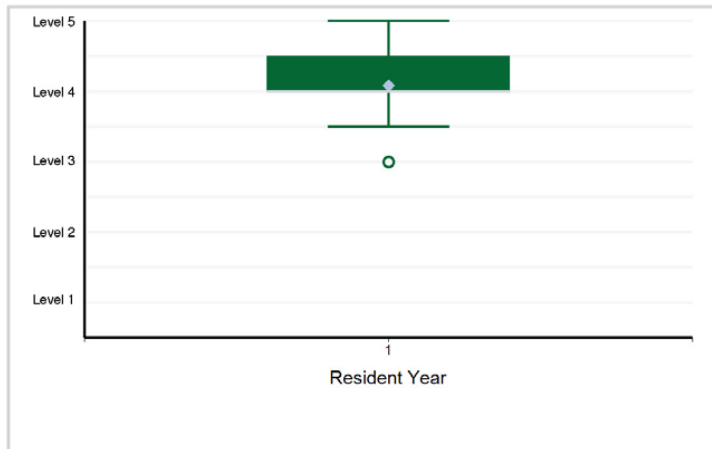

15. Practice-Based Learning and Improvement - Practice-Based Learning and Improvement 2: Reflective Practice and Commitment ...

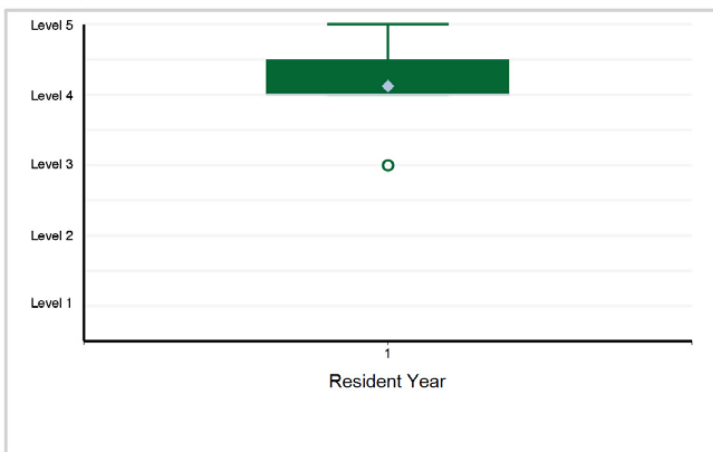

16. Professionalism - Professionalism 1: Professional Behavior and Ethical Principles

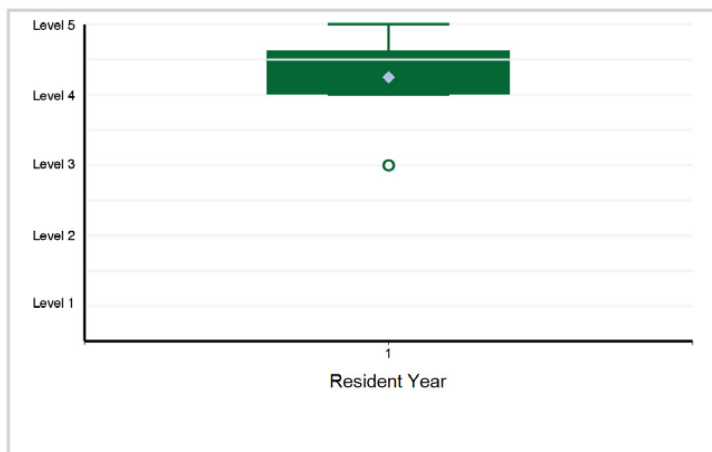

17. Professionalism - Professionalism 2: Accountability and Conscientiousness

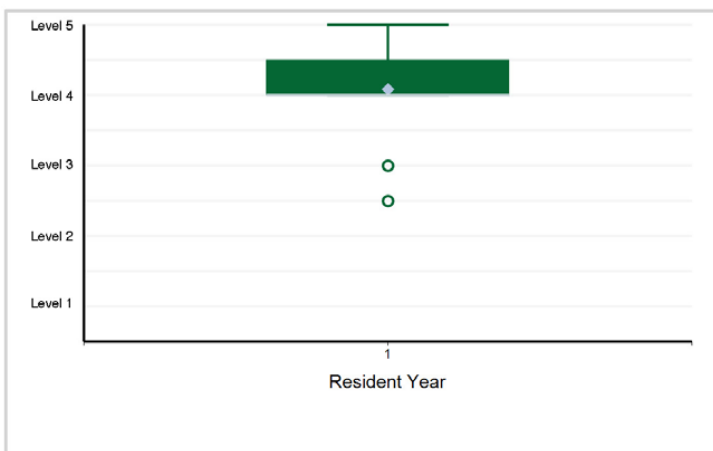

18. Professionalism - Professionalism 3: Self-Awareness and Help-Seeking

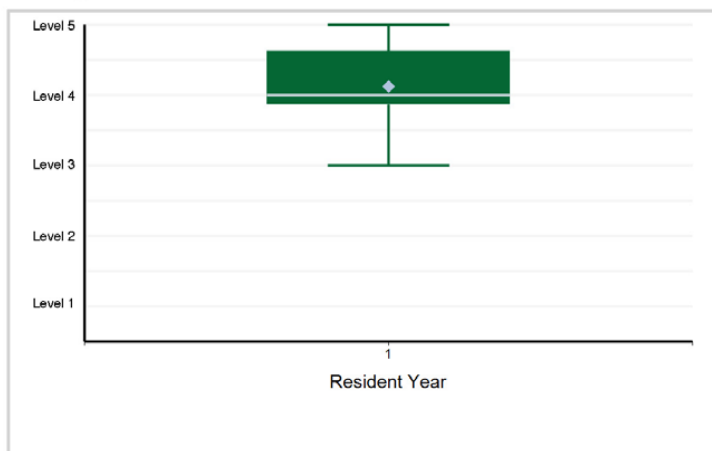

Specialty Box Plot Report - Milestone Evaluation by Resident Year: Year-End 2021-2022

SUBSPECIALTY: Medical Microbiology

19. Interpersonal and Communication Skills - Interpersonal and Communication Skills 1: Patient- and Family-Centered Communication

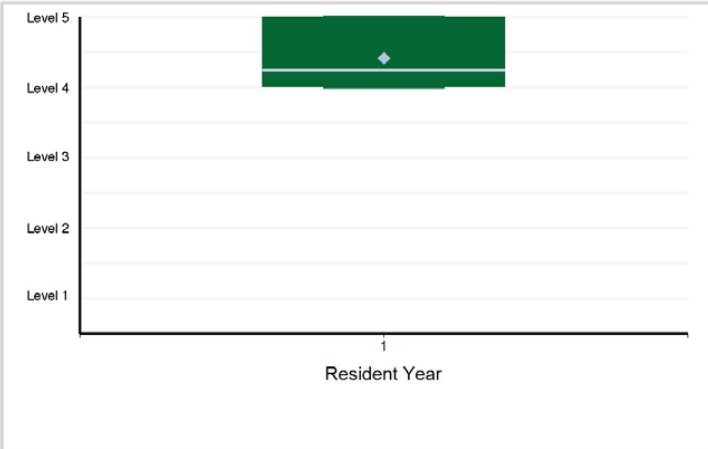

20. Interpersonal and Communication Skills - Interpersonal and Communication Skills 2: Interprofessional and Team Communication

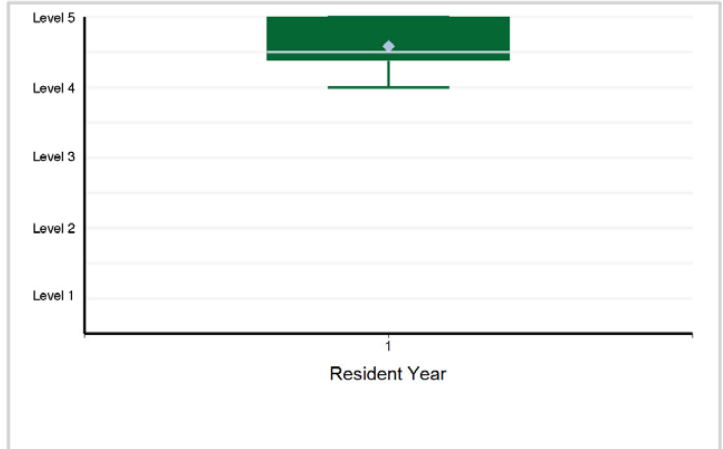

21. Interpersonal and Communication Skills - Interpersonal and Communication Skills 3: Communication within Health Care Systems

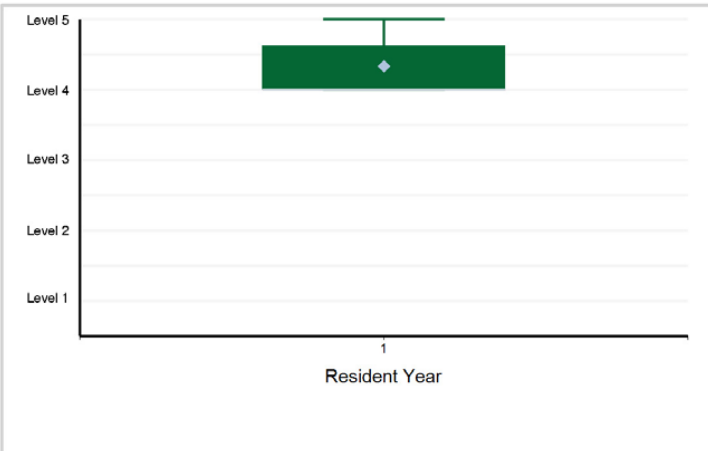

Specialty Box Plot Report - Milestone Evaluation by Resident Year: Year-End 2021-2022

TABLE 89: SUBSPECIALTY: **Neuropathology**

Resident Year	1	2	Total Residents
# of Residents	31	22	53

1. Patient Care - Patient Care 1: Autopsy

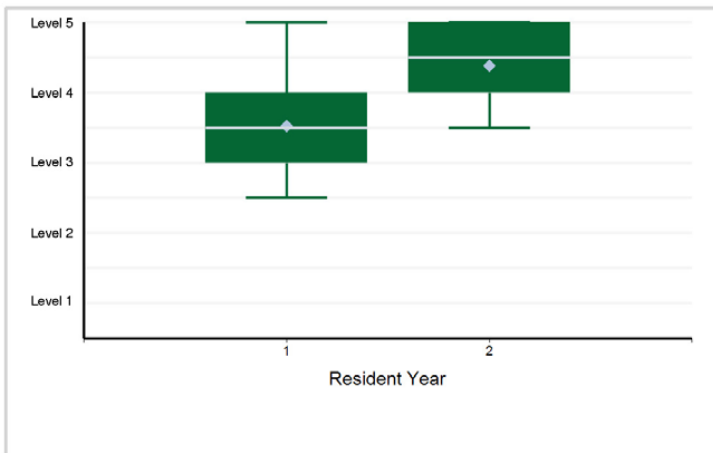

2. Patient Care - Patient Care 2: Surgical Neuropathology

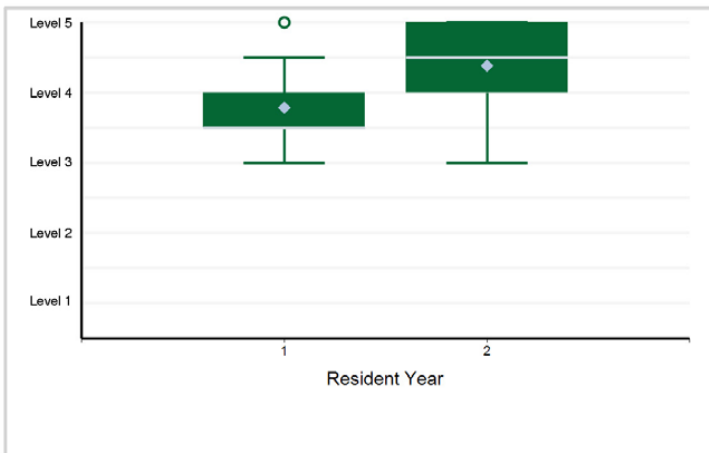

3. Patient Care - Patient Care 3: Intra-Operative Consultation (IOC), including Frozen Section

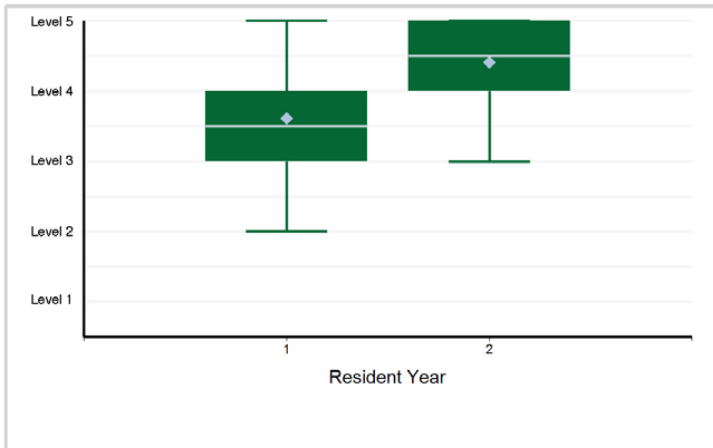

4. Patient Care - Patient Care 4: Reporting

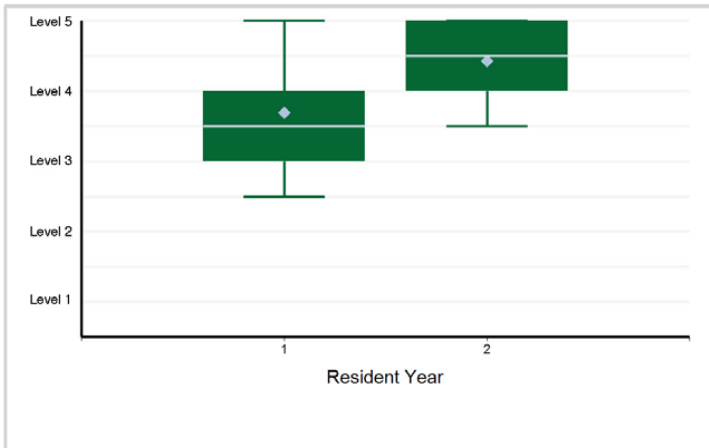

5. Medical Knowledge - Medical Knowledge 1: Diagnostic Knowledge

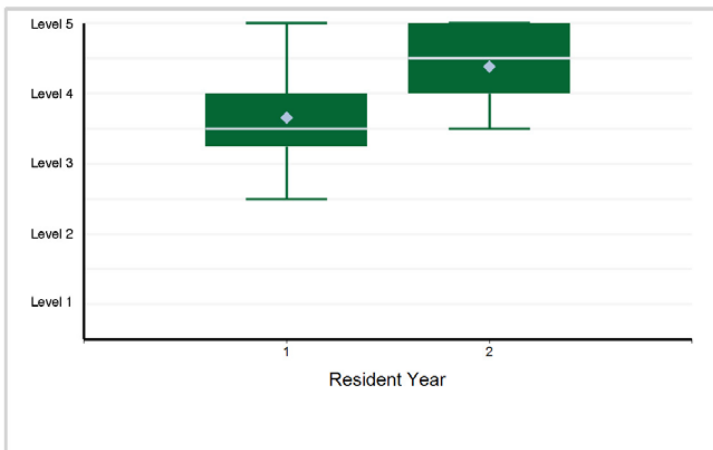

6. Medical Knowledge - Medical Knowledge 2: Neuropathology Instruction

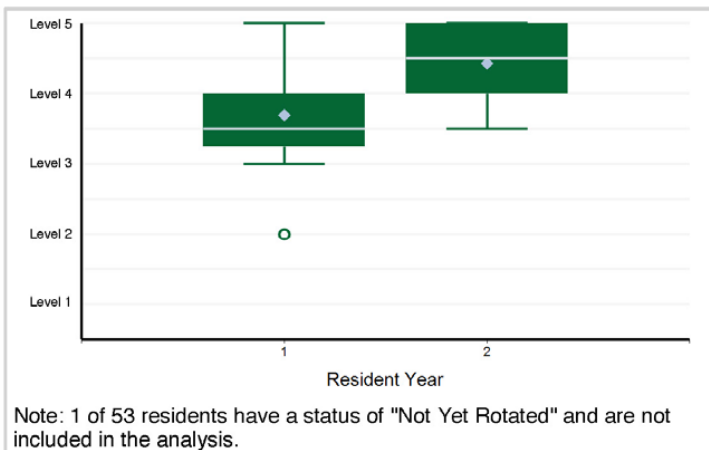

Note: 1 of 53 residents have a status of "Not Yet Rotated" and are not included in the analysis.

Specialty Box Plot Report - Milestone Evaluation by Resident Year: Year-End 2021-2022

SUBSPECIALTY: Neuropathology

7. Medical Knowledge - Medical Knowledge 3: Clinical Reasoning

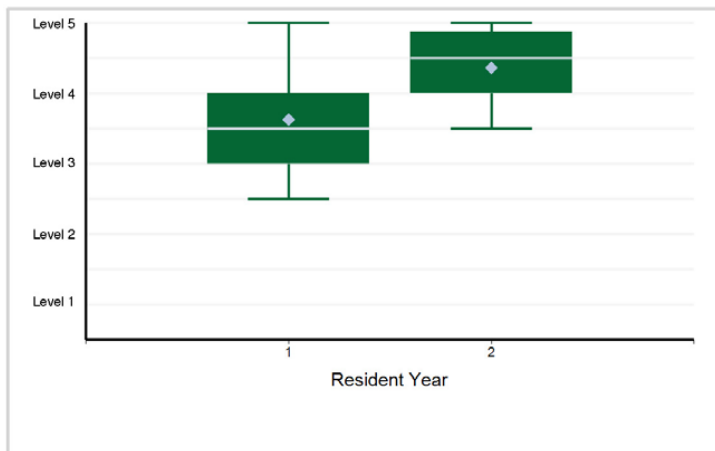

8. Systems-Based Practice - Systems-Based Practice 1: Patient Safety and Quality Improvement (QI)

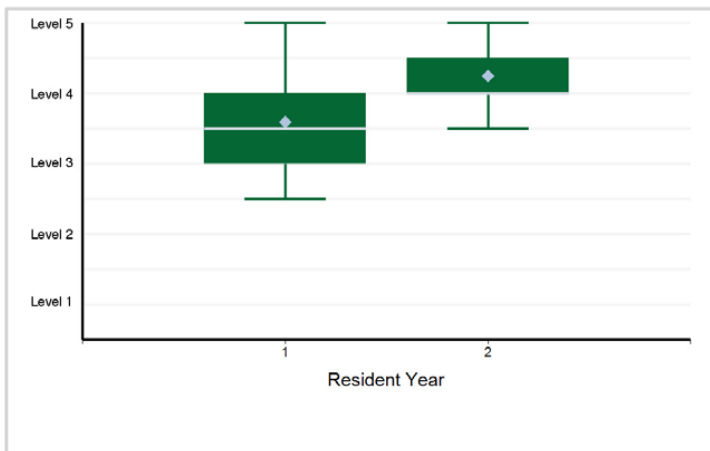

9. Systems-Based Practice - Systems-Based Practice 2: Systems Navigation for Patient-Centered Care

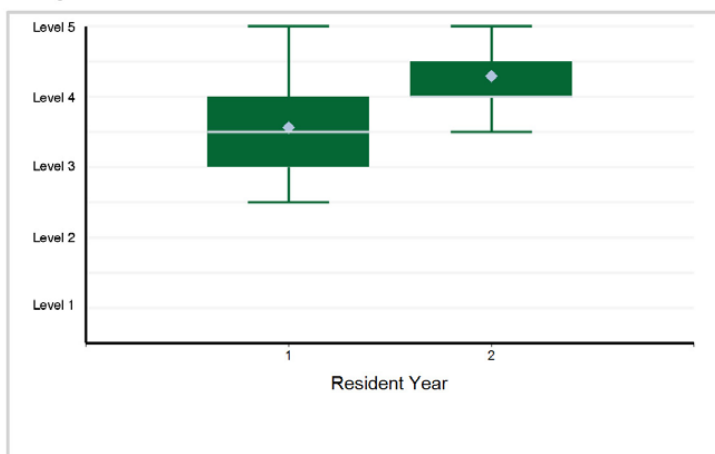

10. Systems-Based Practice - Systems-Based Practice 3: Physician Role in Health Care System

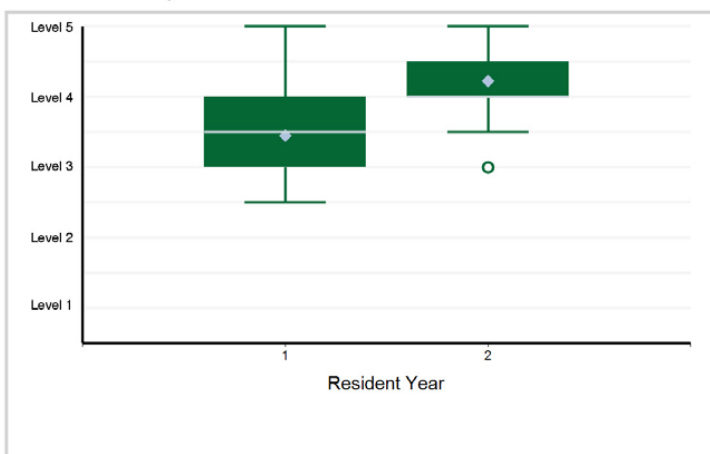

11. Systems-Based Practice - Systems-Based Practice 4: Accreditation, Compliance, and Quality

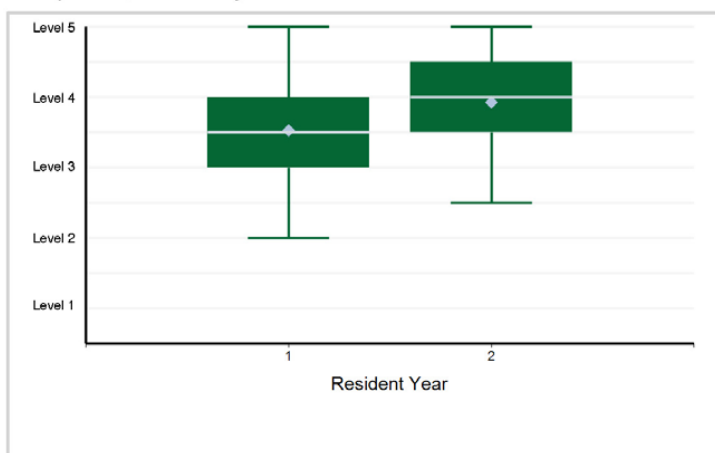

12. Systems-Based Practice - Systems-Based Practice 5: Utilization

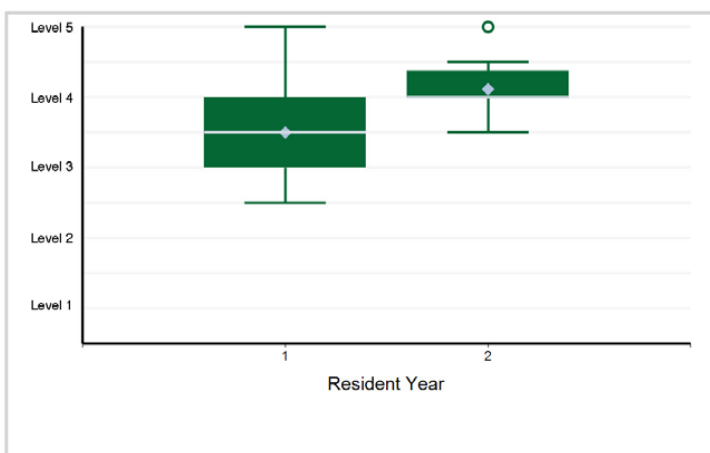

Specialty Box Plot Report - Milestone Evaluation by Resident Year: Year-End 2021-2022

SUBSPECIALTY: **Neuropathology**

13. Practice-Based Learning and Improvement - Practice-Based Learning and Improvement 1: Evidence-Based Practice and Scholarship

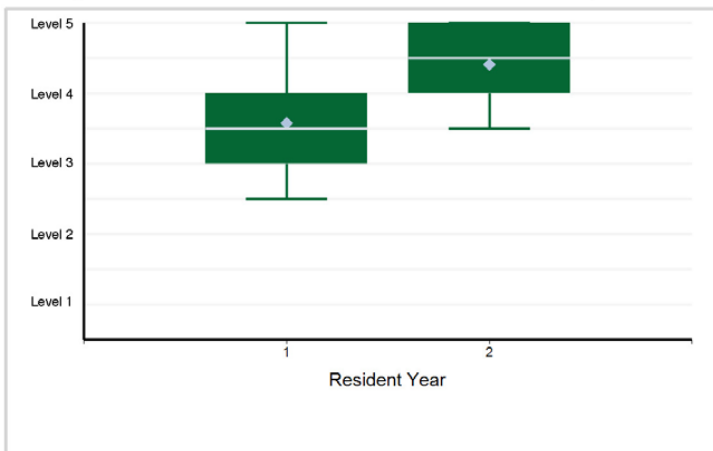

14. Practice-Based Learning and Improvement - Practice-Based Learning and Improvement 2: Reflective Practice and Commitment ...

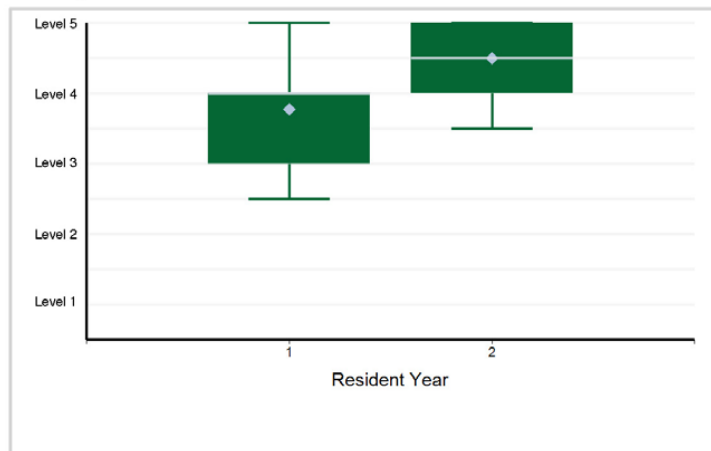

15. Professionalism - Professionalism 1: Professional Behavior and Ethical Principles

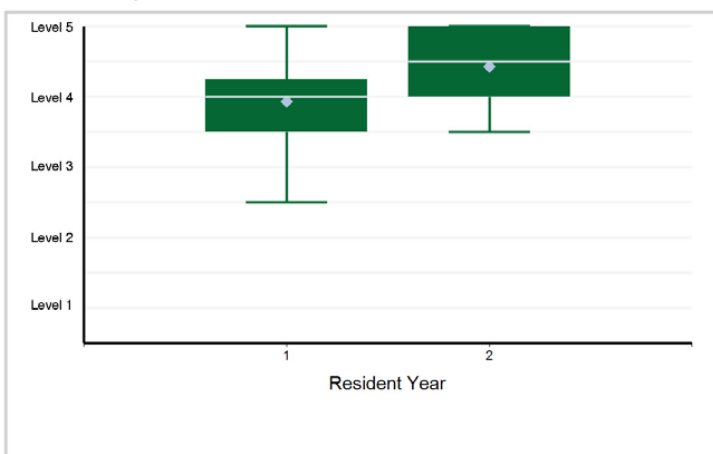

16. Professionalism - Professionalism 2: Accountability and Conscientiousness

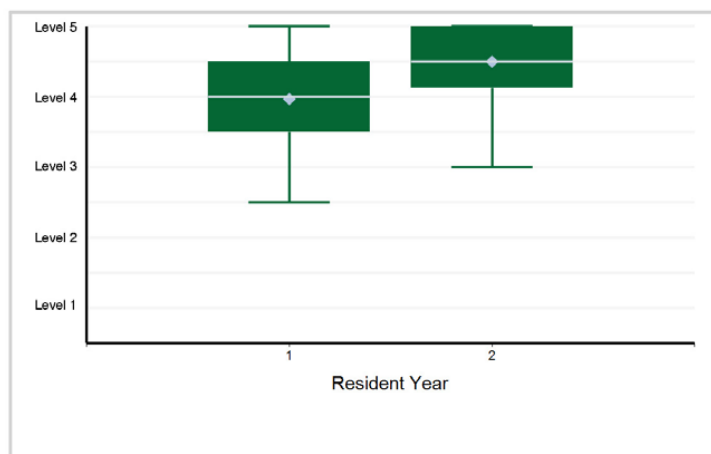

17. Professionalism - Professionalism 3: Self-Awareness and Help-Seeking

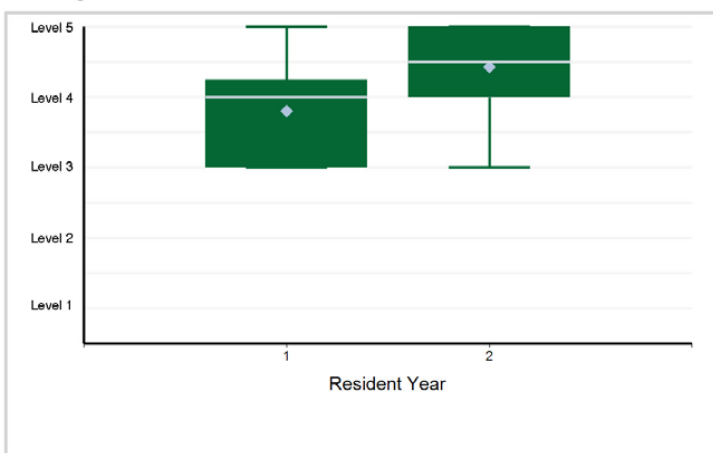

18. Interpersonal and Communication Skills - Interpersonal and Communication Skills 1: Patient- and Family-Centered Communication

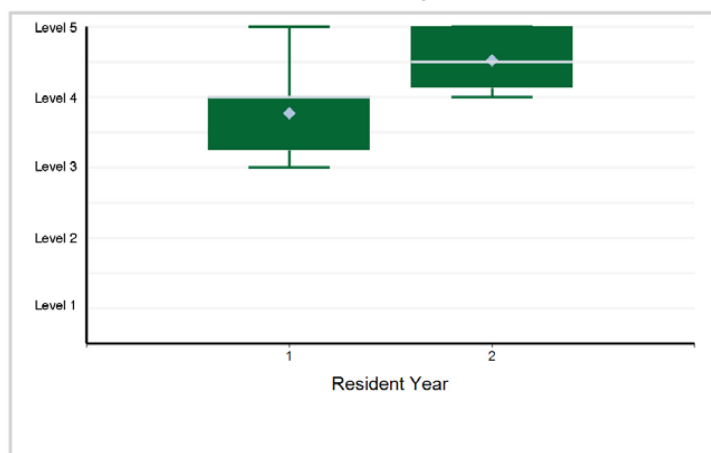

Specialty Box Plot Report - Milestone Evaluation by Resident Year: Year-End 2021-2022

SUBSPECIALTY: **Neuropathology**

19. Interpersonal and Communication Skills - Interpersonal and Communication Skills 2: Interprofessional and Team Communication

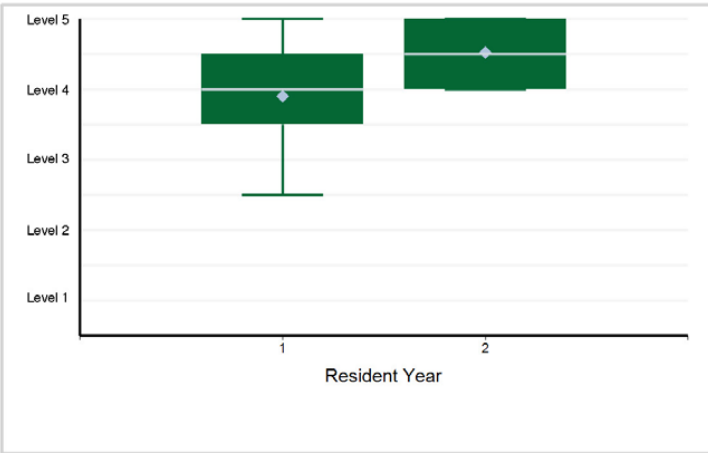

20. Interpersonal and Communication Skills - Interpersonal and Communication Skills 3: Communication within Health Care Systems

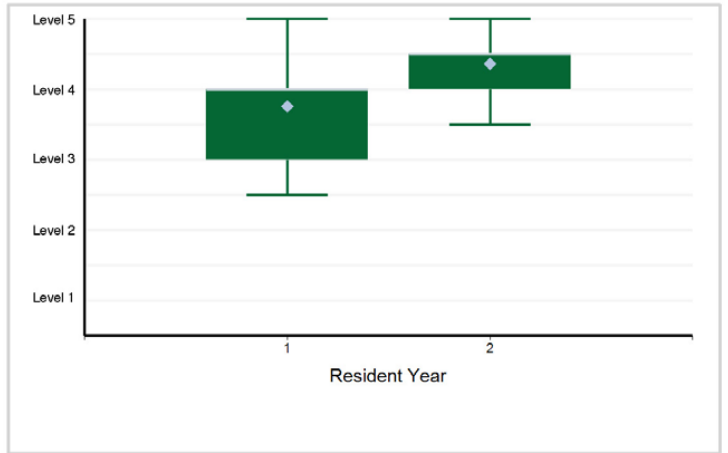

Specialty Box Plot Report - Milestone Evaluation by Resident Year: Year-End 2021-2022

TABLE 90: SUBSPECIALTY: **Pediatric Pathology**

Resident Year	1	Total Residents
# of Residents	22	22

1. Patient Care - Patient Care 1: Pediatric and Perinatal Pathology Grossing (Examine, Describe, Triage, Sample, and Document)

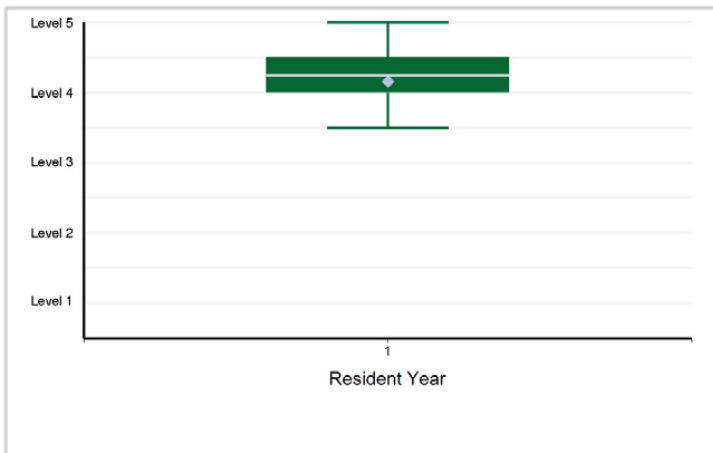

2. Patient Care - Patient Care 2: Intra-Operative Consultation (Frozen Sections, Rapid Onsite Evaluation of Fine Needle Aspiration)

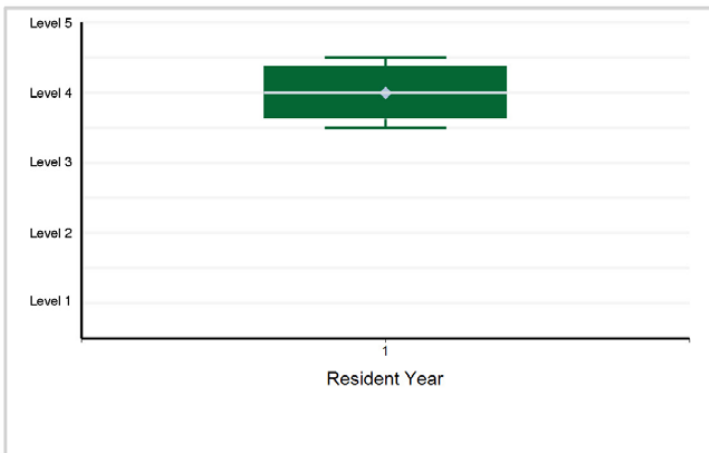

3. Patient Care - Patient Care 3: Autopsy

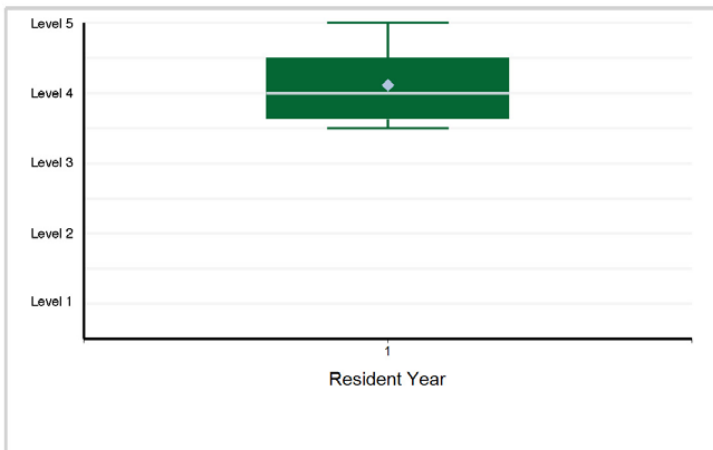

4. Patient Care - Patient Care 4: Reporting, including Surgical Pathology, Cytopathology, and Autopsy

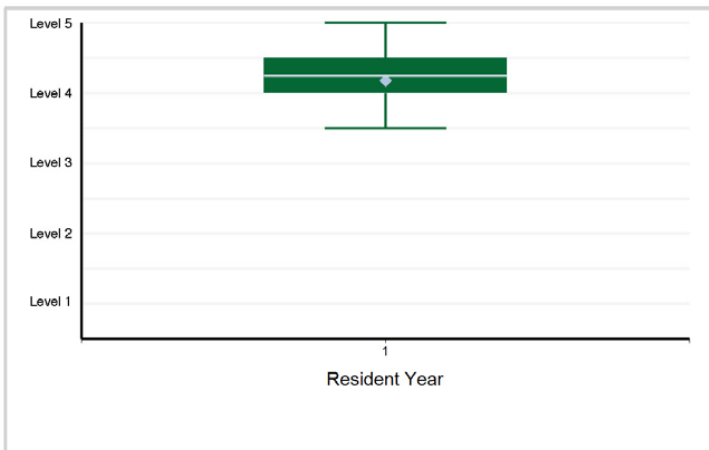

5. Medical Knowledge - Medical Knowledge 1: Knowledge of Pediatric and Perinatal Diseases

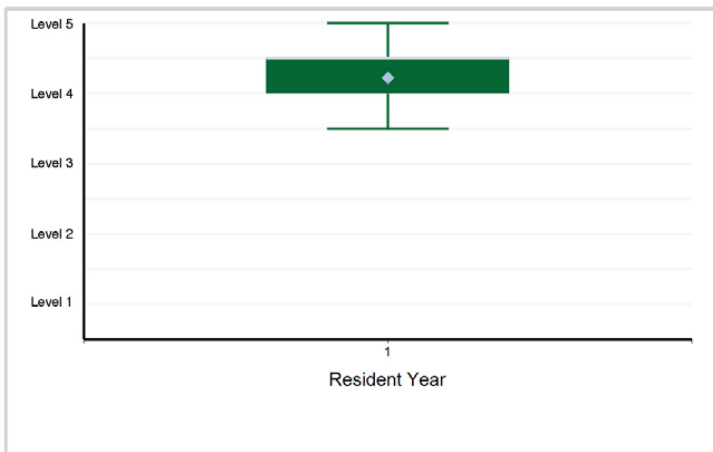

6. Medical Knowledge - Medical Knowledge 2: Clinical Reasoning

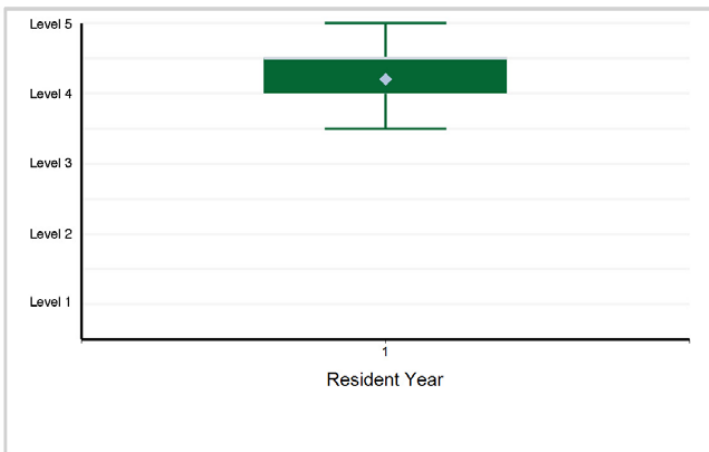

Specialty Box Plot Report - Milestone Evaluation by Resident Year: Year-End 2021-2022

SUBSPECIALTY: Pediatric Pathology

7. Systems-Based Practice - Systems-Based Practice 1: Patient Safety and Quality Improvement (QI)

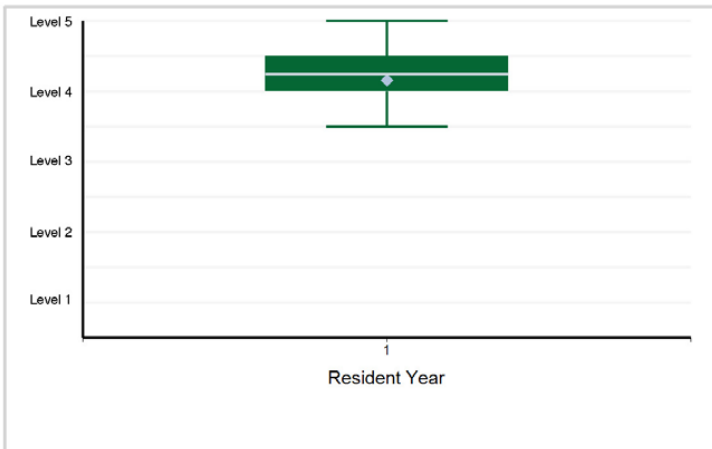

8. Systems-Based Practice - Systems-Based Practice 2: Systems Navigation for Patient-Centered Care

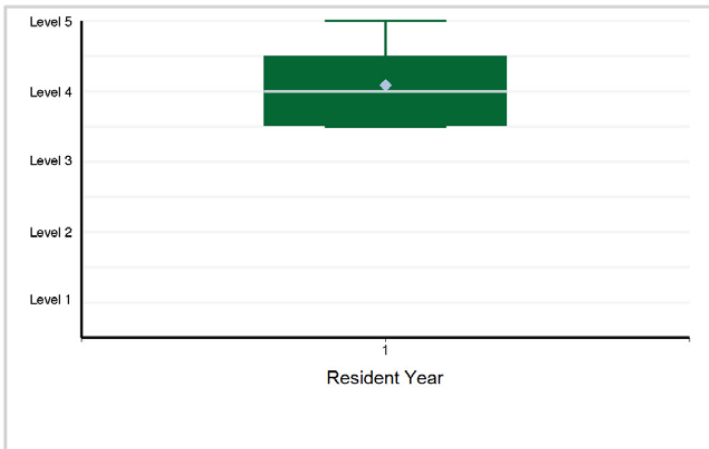

9. Systems-Based Practice - Systems-Based Practice 3: Physician Role in Health Care System

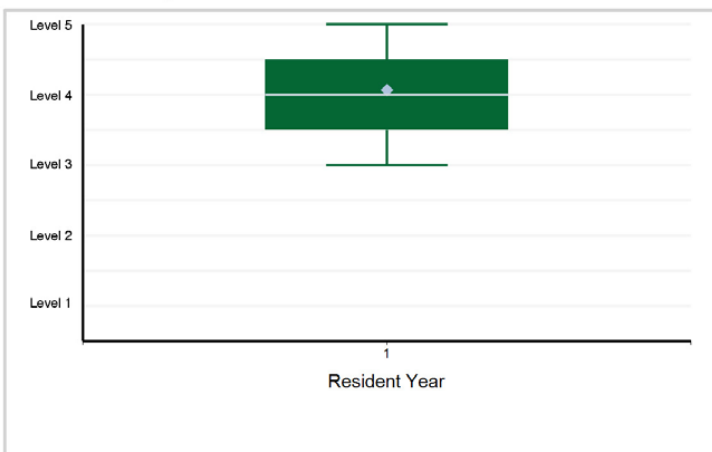

10. Systems-Based Practice - Systems-Based Practice 4: Accreditation, Compliance, and Quality

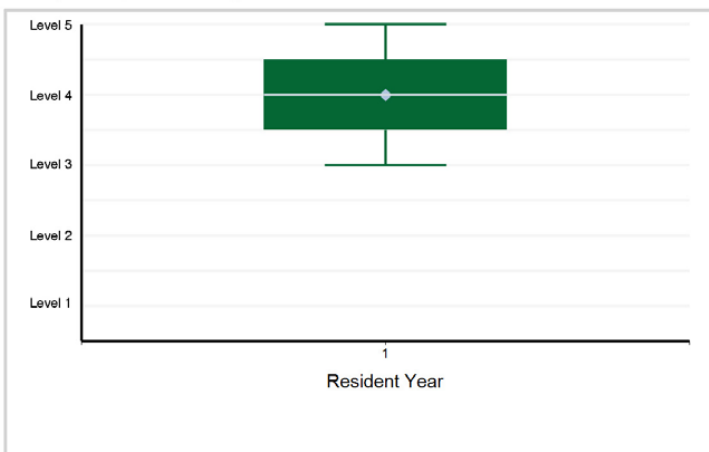

11. Systems-Based Practice - Systems-Based Practice 5: Utilization

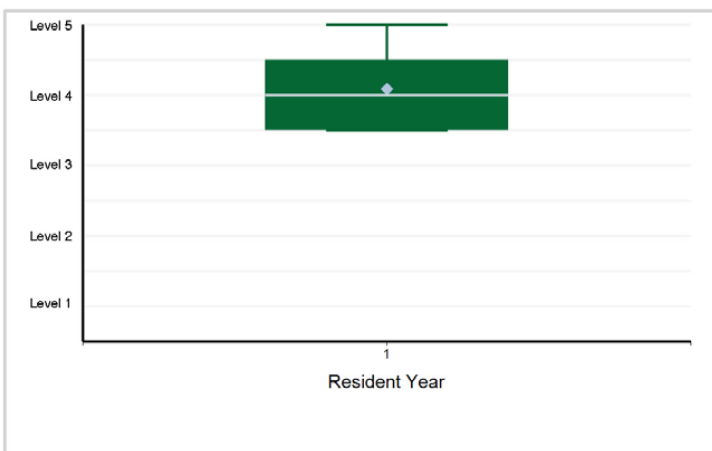

12. Practice-Based Learning and Improvement - Practice-Based Learning and Improvement 1: Evidence-Based Practice and Scholarship

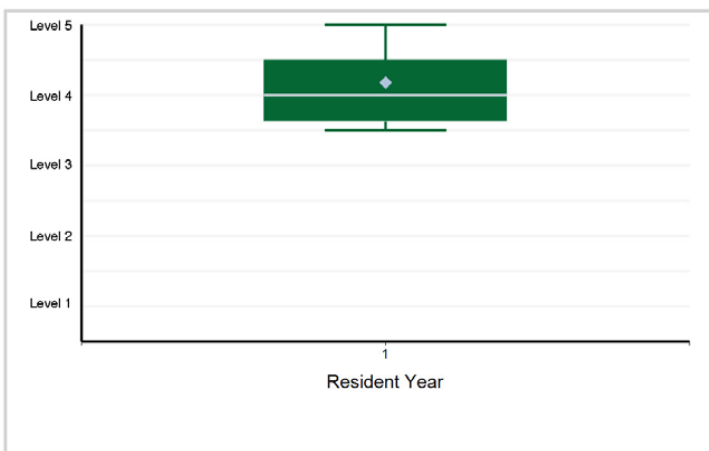

Specialty Box Plot Report - Milestone Evaluation by Resident Year: Year-End 2021-2022

SUBSPECIALTY: Pediatric Pathology

13. Practice-Based Learning and Improvement - Practice-Based Learning and Improvement 2: Reflective Practice and Commitment ...

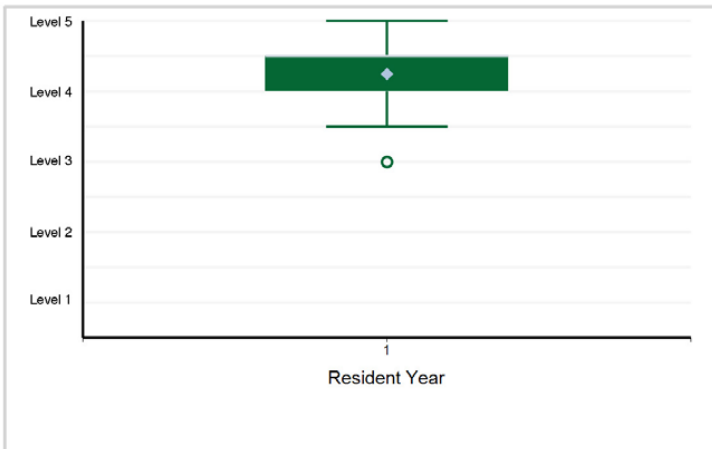

14. Professionalism - Professionalism 1: Professional Behavior and Ethical Principles

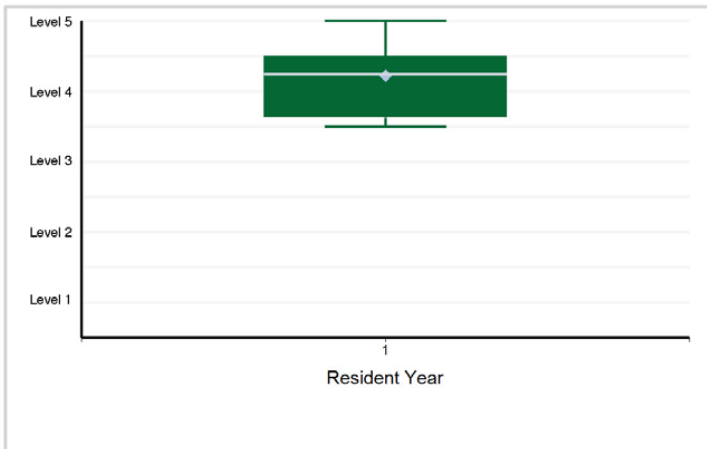

15. Professionalism - Professionalism 2: Accountability and Conscientiousness

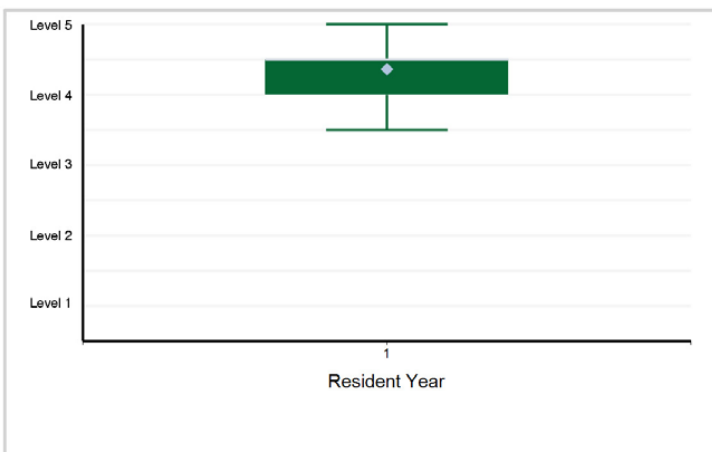

16. Professionalism - Professionalism 3: Self-Awareness and Help-Seeking

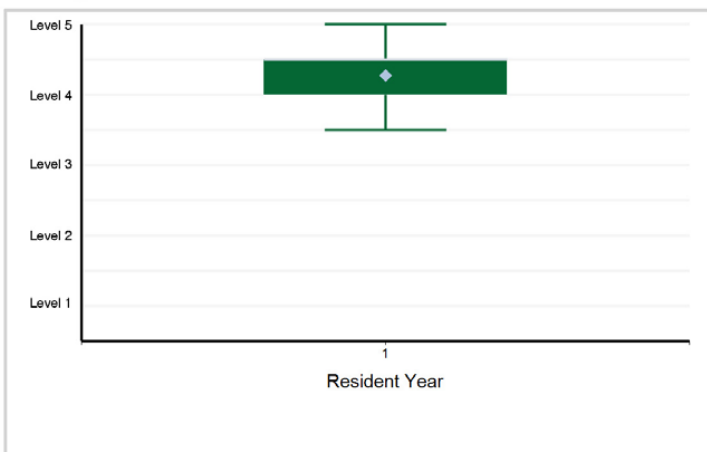

17. Interpersonal and Communication Skills - Interpersonal and Communication Skills 1: Patient- and Family-Centered Communication

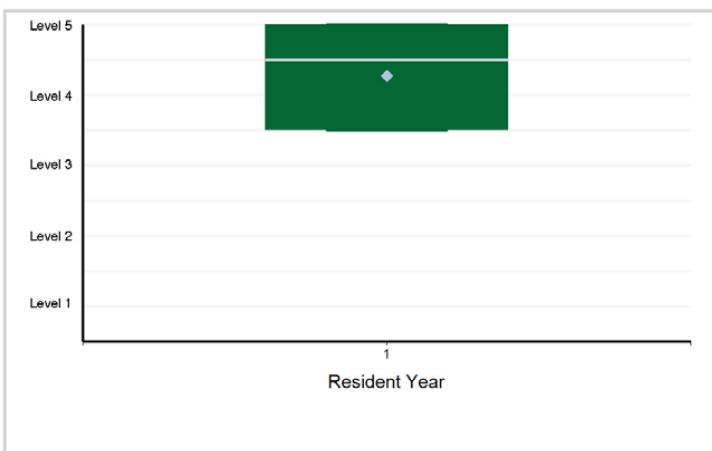

18. Interpersonal and Communication Skills - Interpersonal and Communication Skills 2: Interprofessional and Team Communication

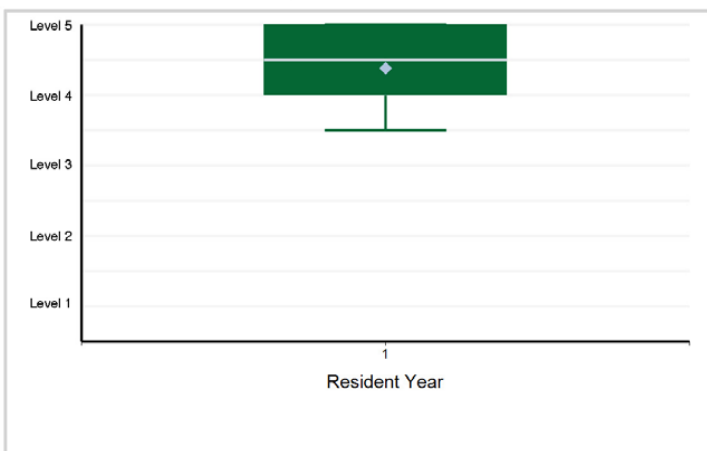

Specialty Box Plot Report - Milestone Evaluation by Resident Year: Year-End 2021-2022

SUBSPECIALTY: **Pediatric Pathology**

19. Interpersonal and Communication Skills - Interpersonal and Communication Skills 3: Communication within Health Care Systems

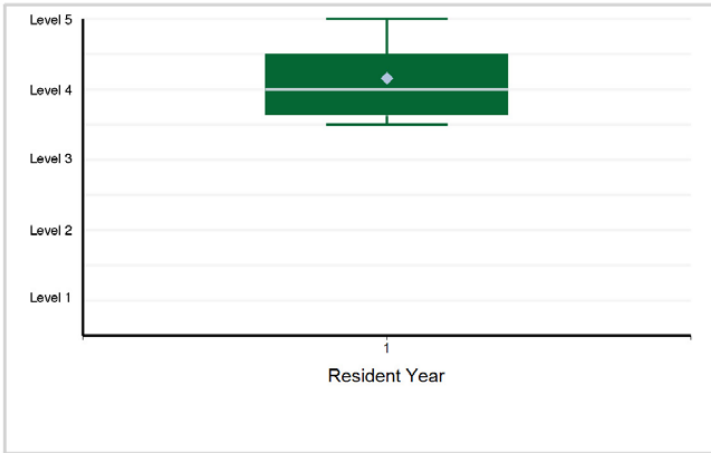

Specialty Box Plot Report - Milestone Evaluation by Resident Year: Year-End 2021-2022

TABLE 91: SUBSPECIALTY: **Selective Pathology - Focused Anatomic**

Resident Year	1	Total Residents
# of Residents	104	104

1. Patient Care - Patient Care 1: Reporting (Track A, B, and C)

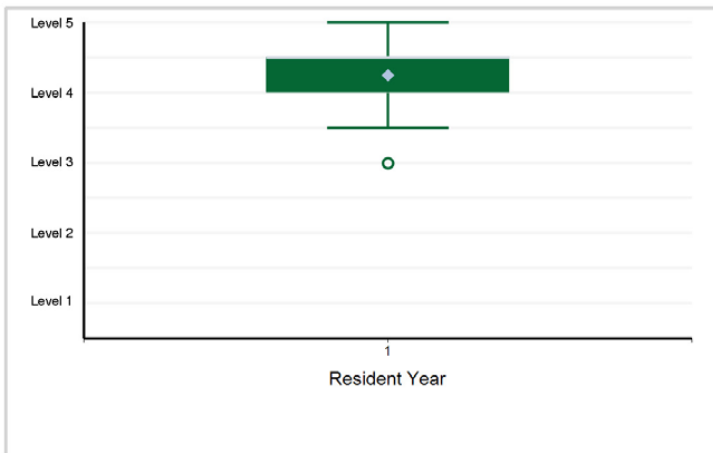

2. Patient Care - Patient Care 2: Gross Examination (Track A and B)

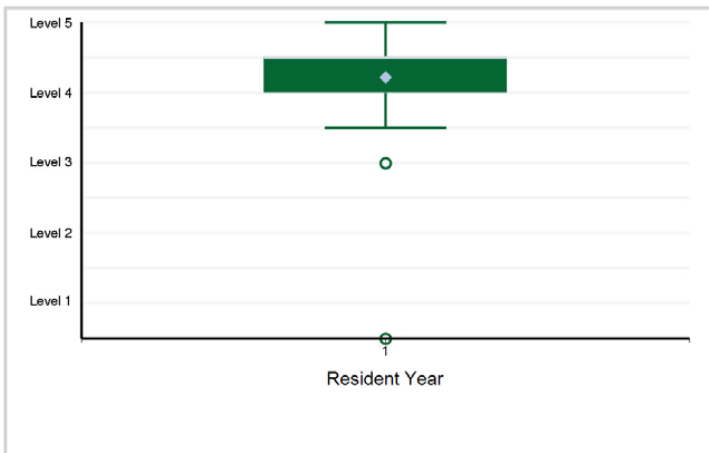

3. Patient Care - Patient Care 3: Intra-Operative Consultation (IOC), including Frozen Section (Track A and B)

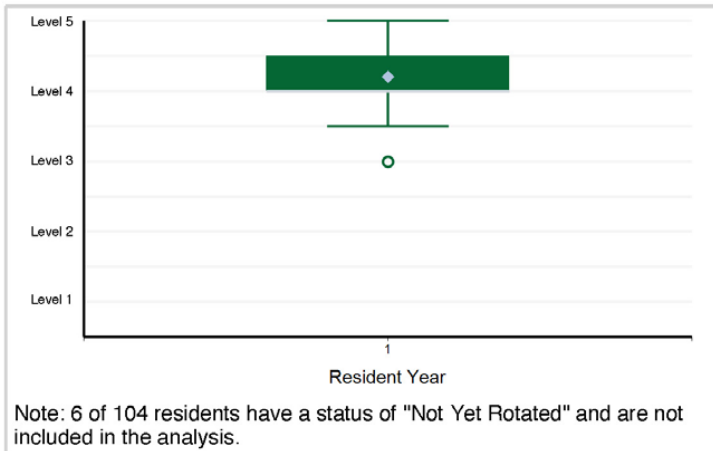

4. Patient Care - Patient Care 4: Microscopic Examination and Ancillary Testing for Diagnosis (Track A and B)

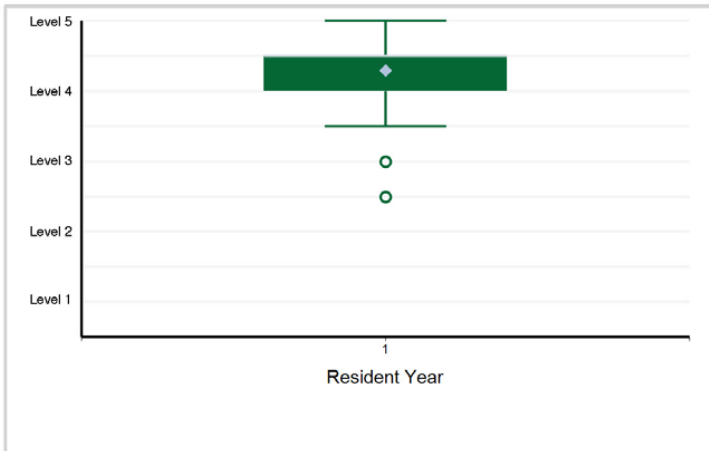

5. Medical Knowledge - Medical Knowledge 1: Clinical Reasoning (Track A, B, and C)

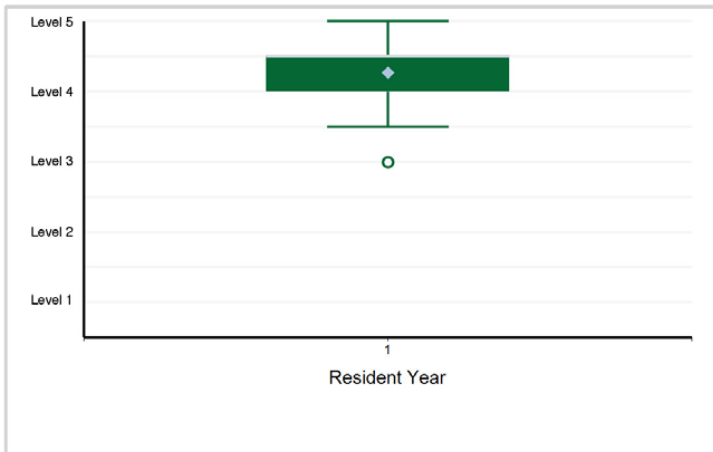

6. Medical Knowledge - Medical Knowledge 2: Knowledge of Established and Evolving Biomedical, Clinical, ...

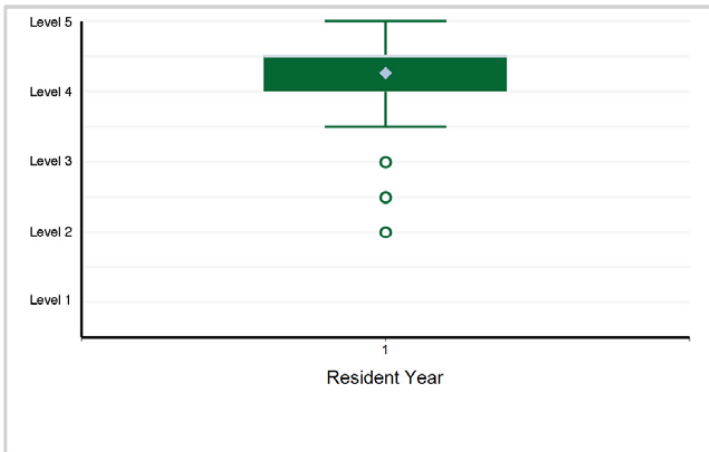

Specialty Box Plot Report - Milestone Evaluation by Resident Year: Year-End 2021-2022

SUBSPECIALTY: Selective Pathology - Focused Anatomic

7. Systems-Based Practice - Systems-Based Practice 1: Patient Safety and Quality Improvement (QI) (Track A, B, and C)

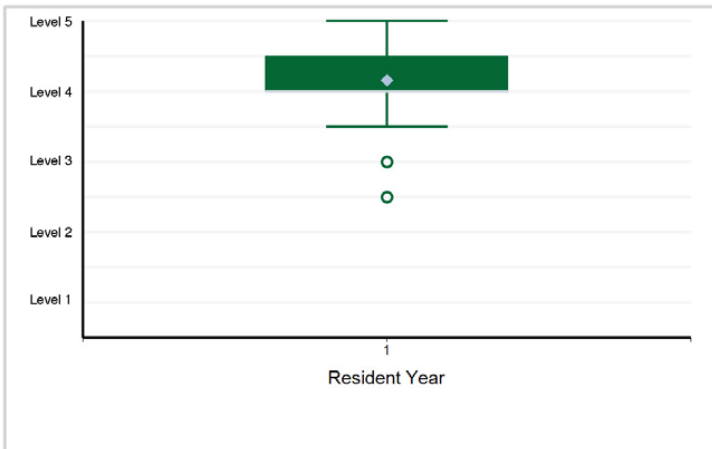

8. Systems-Based Practice - Systems-Based Practice 2: Systems Navigation for Patient-Centered Care (Track A, B, and C)

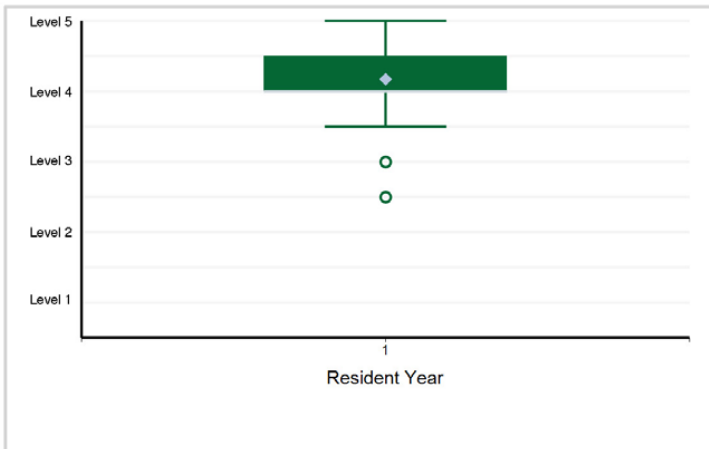

9. Systems-Based Practice - Systems-Based Practice 3: Physician Role in Health Care System (Track A, B, and C)

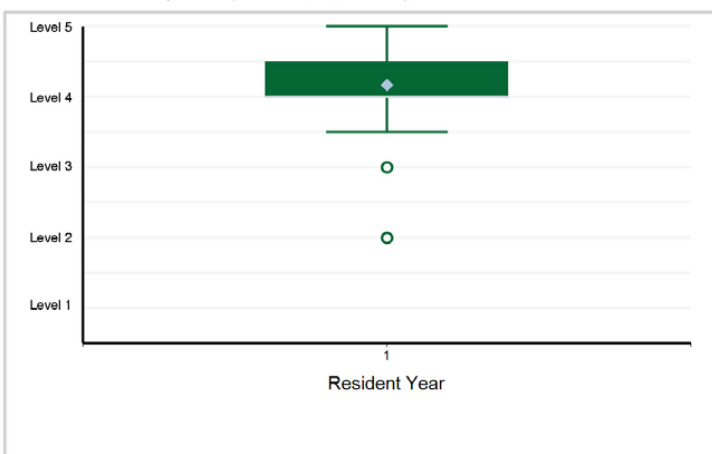

10. Systems-Based Practice - Systems-Based Practice 4: Accreditation, Compliance, and Quality (Track A, B, and C)

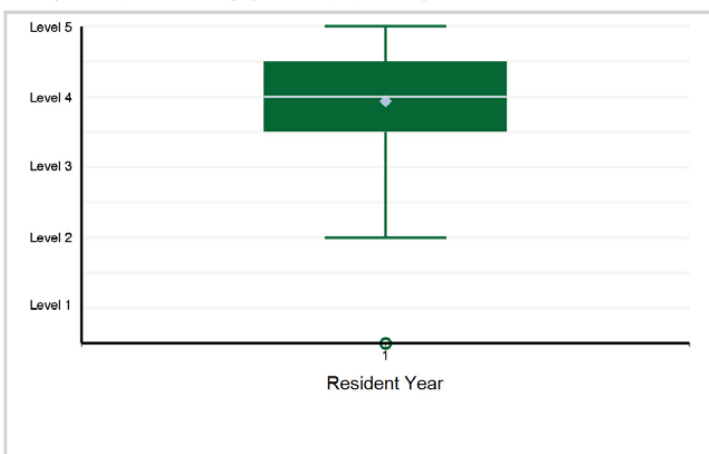

11. Systems-Based Practice - Systems-Based Practice 5: Utilization (Track A, B, and C)

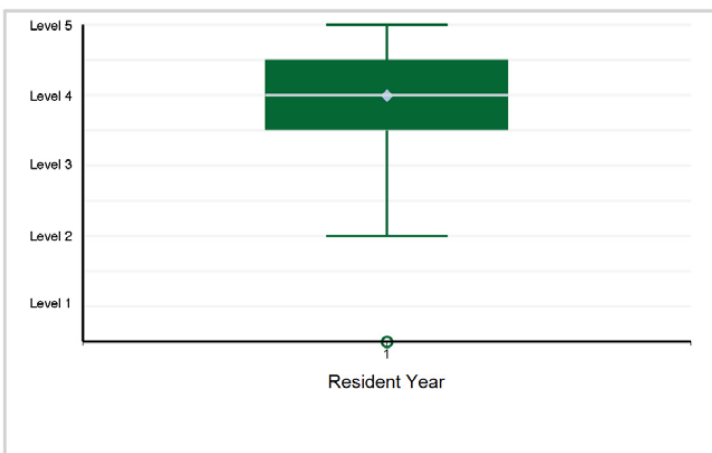

12. Practice-Based Learning and Improvement - Practice-Based Learning and Improvement 1: Evidence-Based ...

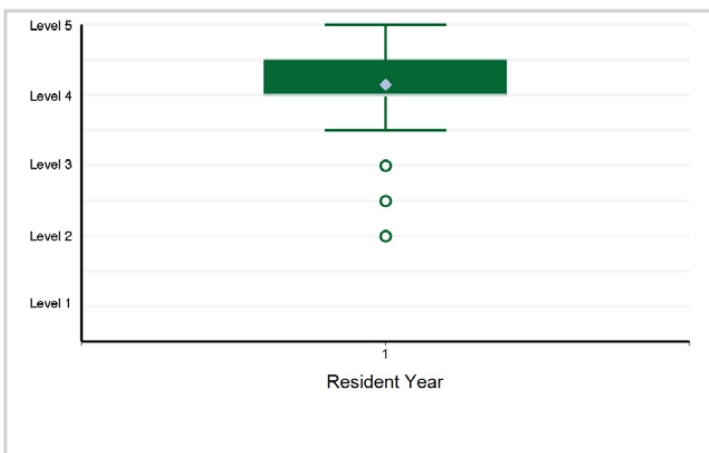

Specialty Box Plot Report - Milestone Evaluation by Resident Year: Year-End 2021-2022

SUBSPECIALTY: Selective Pathology - Focused Anatomic

13. Practice-Based Learning and Improvement - Practice-Based Learning and Improvement 2: Reflective Practice and Commitment ...

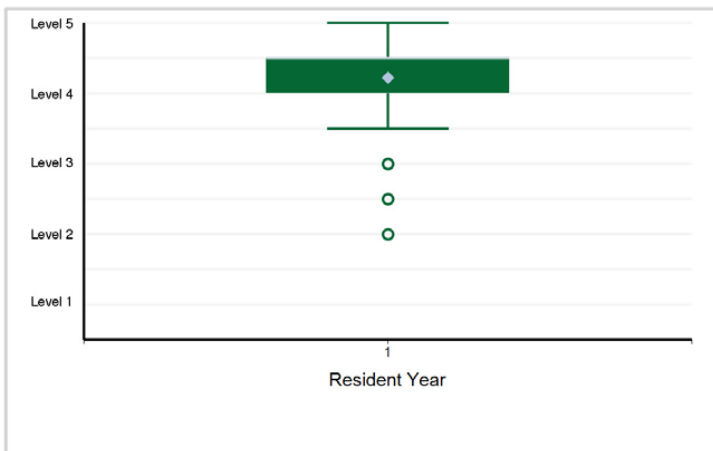

14. Professionalism - Professionalism 1: Professional Behavior and Ethical Principles (Track A, B, and C)

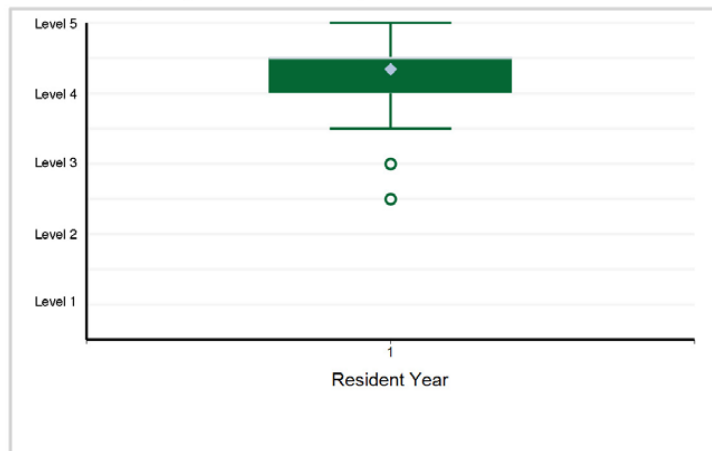

15. Professionalism - Professionalism 2: Accountability and Conscientiousness (Track A, B, and C)

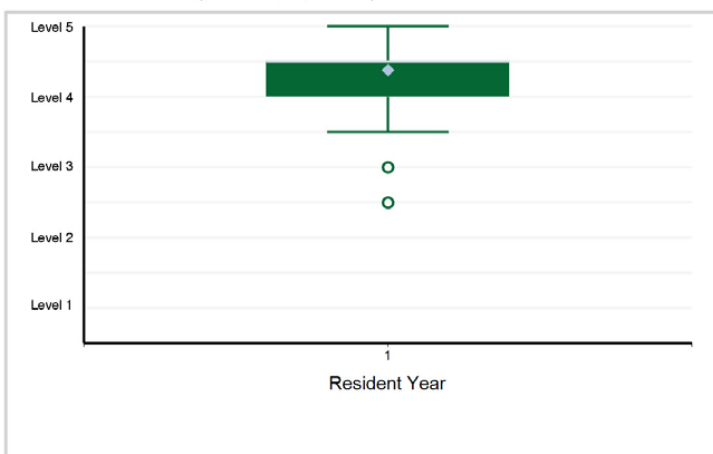

16. Professionalism - Professionalism 3: Self-Awareness and Help-Seeking (Track A, B, and C)

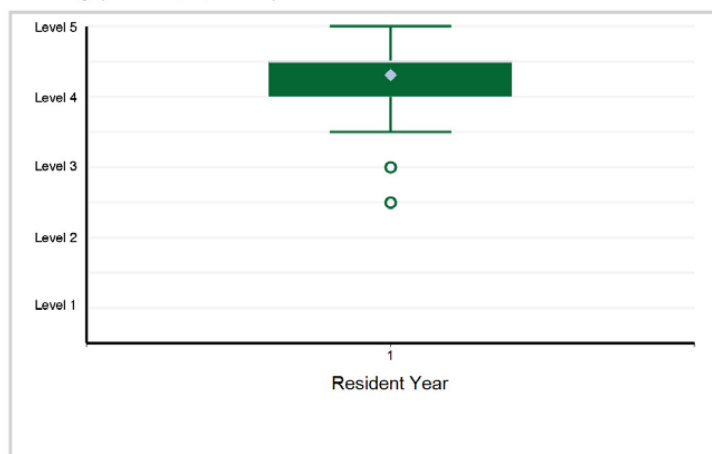

17. Interpersonal and Communication Skills - Interpersonal and Communication Skills 1: Patient- and Family-Centered ...

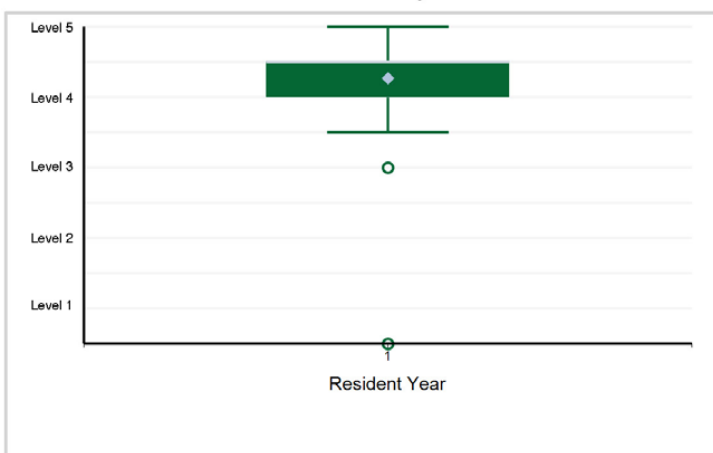

18. Interpersonal and Communication Skills - Interpersonal and Communication Skills 2: Interprofessional ...

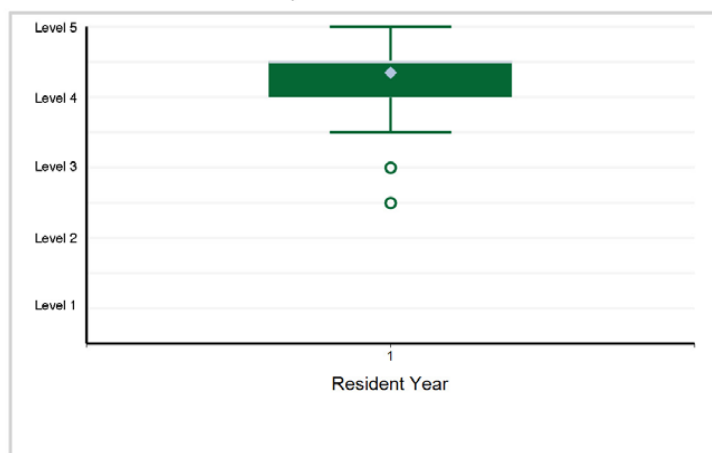

Specialty Box Plot Report - Milestone Evaluation by Resident Year: Year-End 2021-2022

SUBSPECIALTY: **Selective Pathology - Focused Anatomic**

19. Interpersonal and Communication Skills - Interpersonal and Communication Skills 3: Communication within ...

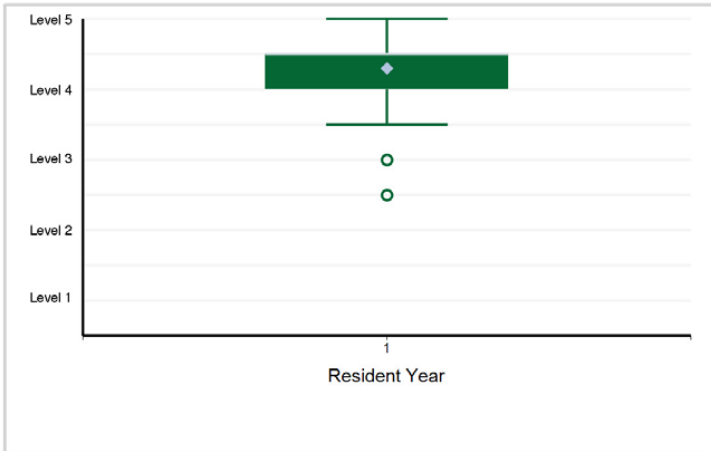

Specialty Box Plot Report - Milestone Evaluation by Resident Year: Year-End 2021-2022

TABLE 92: SUBSPECIALTY: **Selective Pathology - Surgical**

Resident Year	1	Total Residents
# of Residents	82	82

1. Patient Care - Patient Care 1: Reporting (Track A, B, and C)

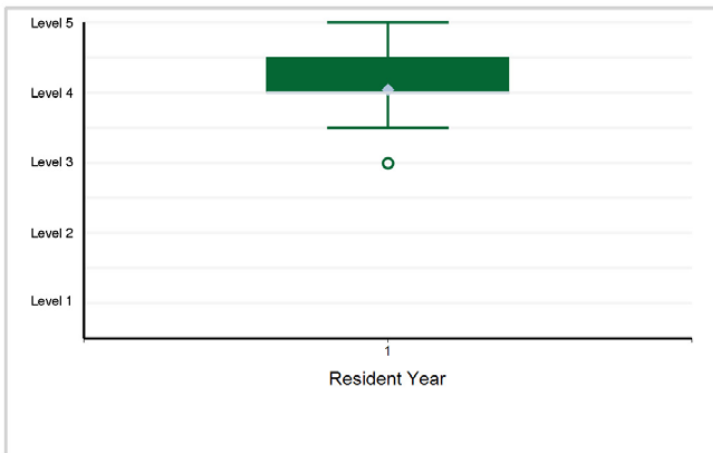

2. Patient Care - Patient Care 2: Gross Examination (Track A and B)

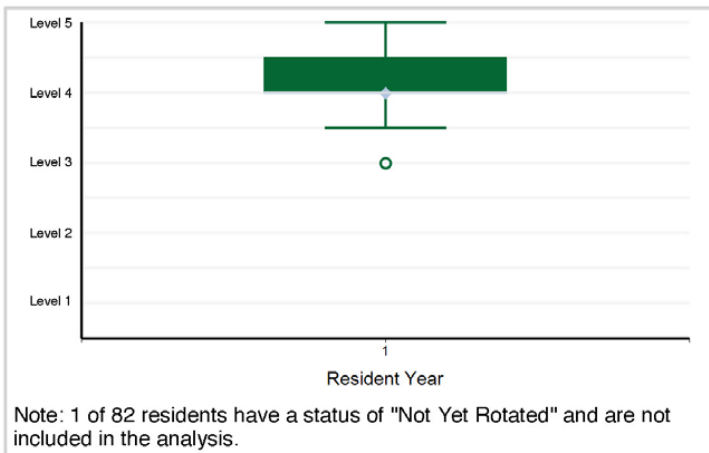

3. Patient Care - Patient Care 3: Intra-Operative Consultation (IOC), including Frozen Section (Track A and B)

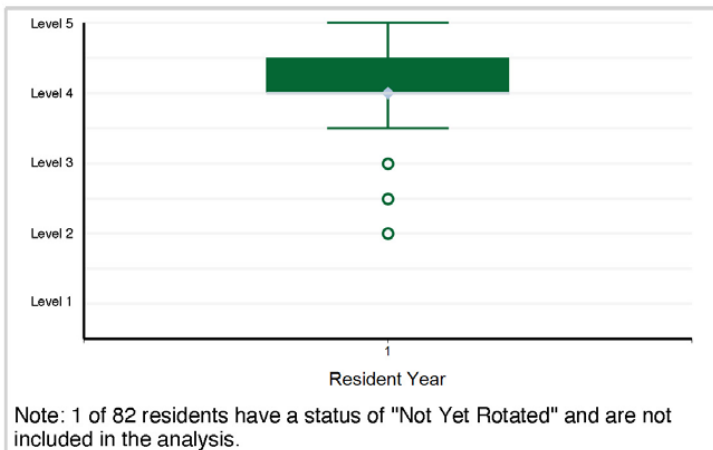

4. Patient Care - Patient Care 4: Microscopic Examination and Ancillary Testing for Diagnosis (Track A and B)

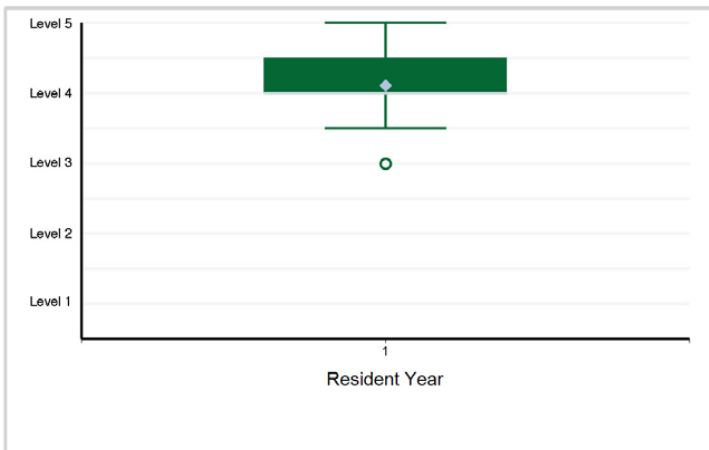

5. Medical Knowledge - Medical Knowledge 1: Clinical Reasoning (Track A, B, and C)

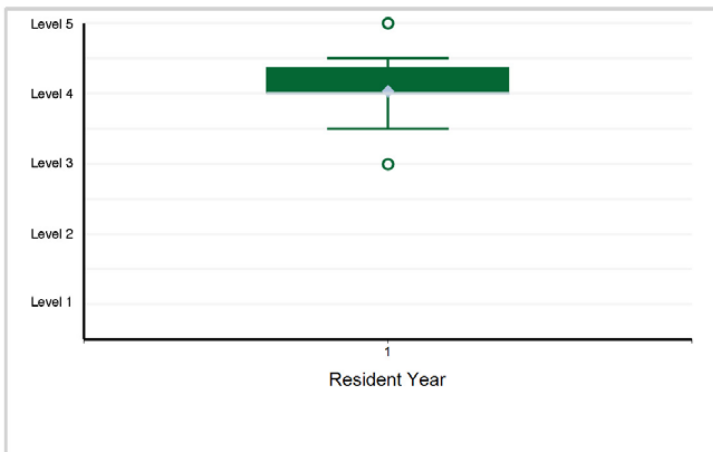

6. Medical Knowledge - Medical Knowledge 2: Knowledge of Established and Evolving Biomedical, Clinical, ...

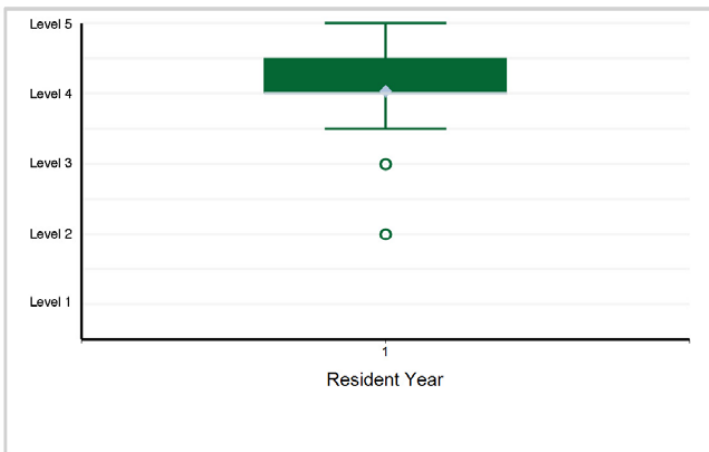

Specialty Box Plot Report - Milestone Evaluation by Resident Year: Year-End 2021-2022

SUBSPECIALTY: Selective Pathology - Surgical

7. Systems-Based Practice - Systems-Based Practice 1: Patient Safety and Quality Improvement (QI) (Track A, B, and C)

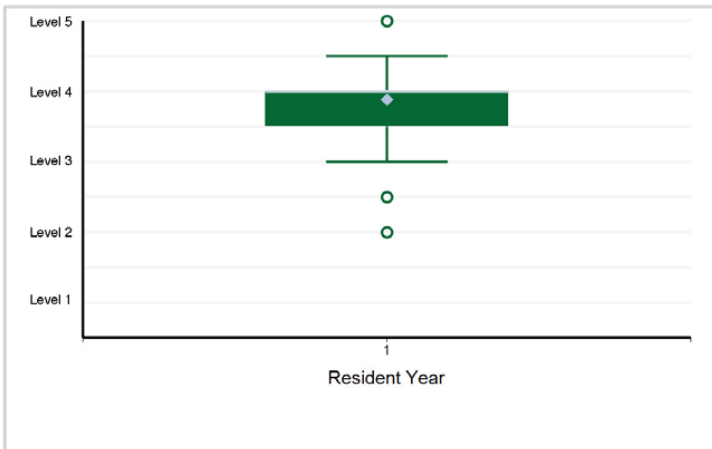

8. Systems-Based Practice - Systems-Based Practice 2: Systems Navigation for Patient-Centered Care (Track A, B, and C)



9. Systems-Based Practice - Systems-Based Practice 3: Physician Role in Health Care System (Track A, B, and C)

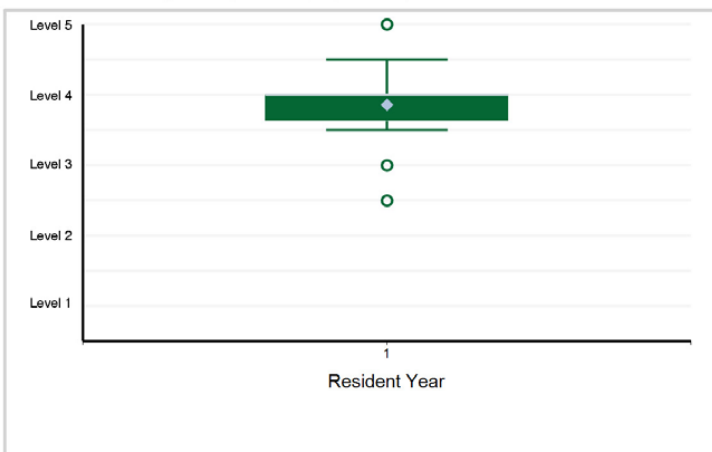

10. Systems-Based Practice - Systems-Based Practice 4: Accreditation, Compliance, and Quality (Track A, B, and C)

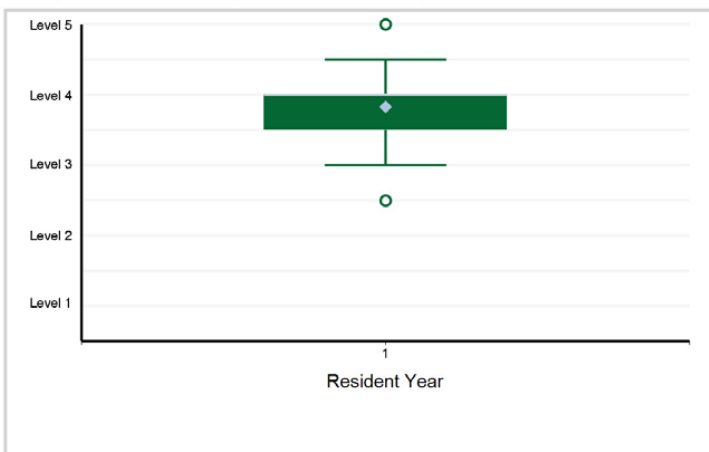

11. Systems-Based Practice - Systems-Based Practice 5: Utilization (Track A, B, and C)



12. Practice-Based Learning and Improvement - Practice-Based Learning and Improvement 1: Evidence-Based ...

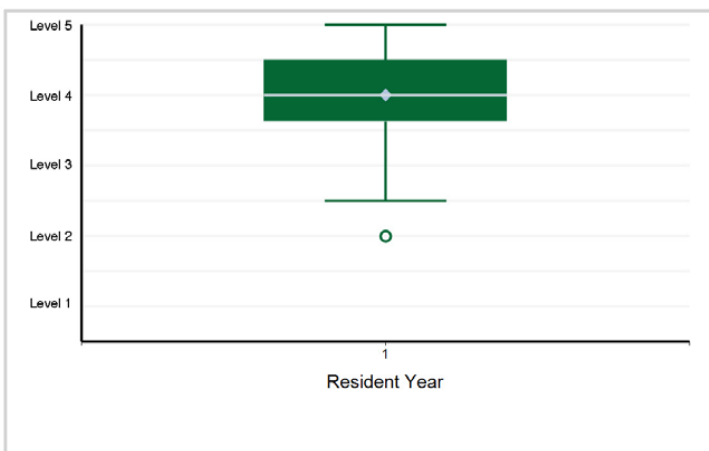

Specialty Box Plot Report - Milestone Evaluation by Resident Year: Year-End 2021-2022

SUBSPECIALTY: Selective Pathology - Surgical

13. Practice-Based Learning and Improvement - Practice-Based Learning and Improvement 2: Reflective Practice and Commitment ...

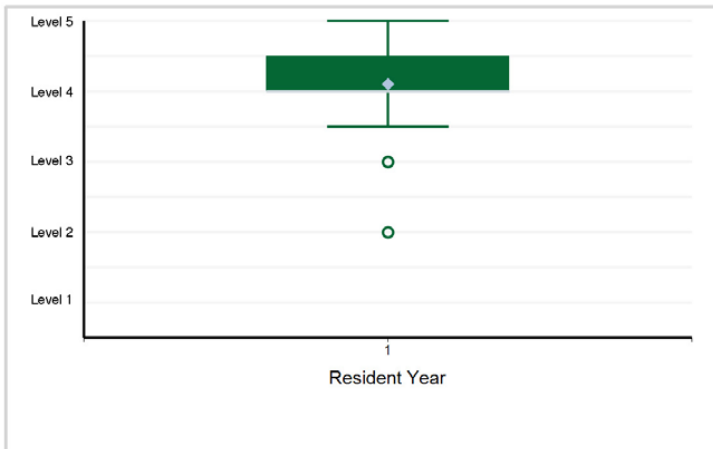

14. Professionalism - Professionalism 1: Professional Behavior and Ethical Principles (Track A, B, and C)

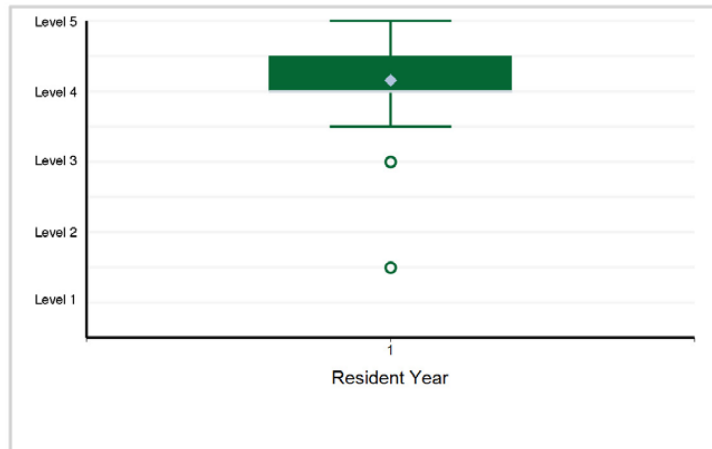

15. Professionalism - Professionalism 2: Accountability and Conscientiousness (Track A, B, and C)

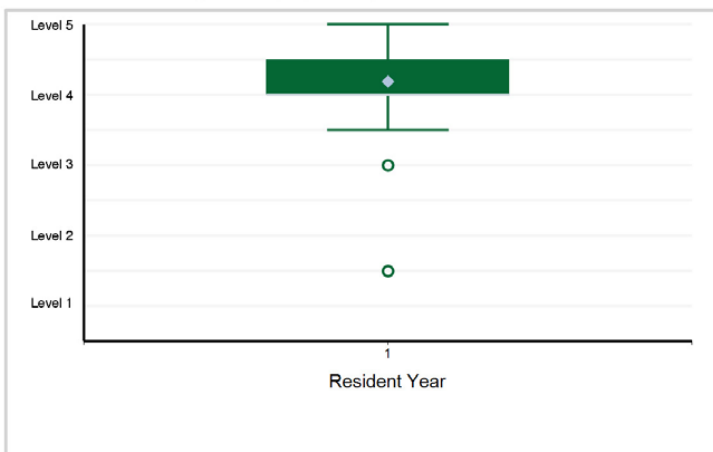

16. Professionalism - Professionalism 3: Self-Awareness and Help-Seeking (Track A, B, and C)

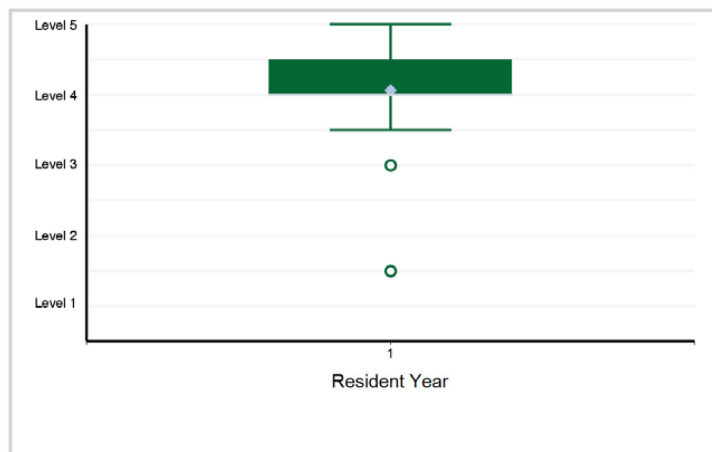

17. Interpersonal and Communication Skills - Interpersonal and Communication Skills 1: Patient- and Family-Centered ...



18. Interpersonal and Communication Skills - Interpersonal and Communication Skills 2: Interprofessional ...

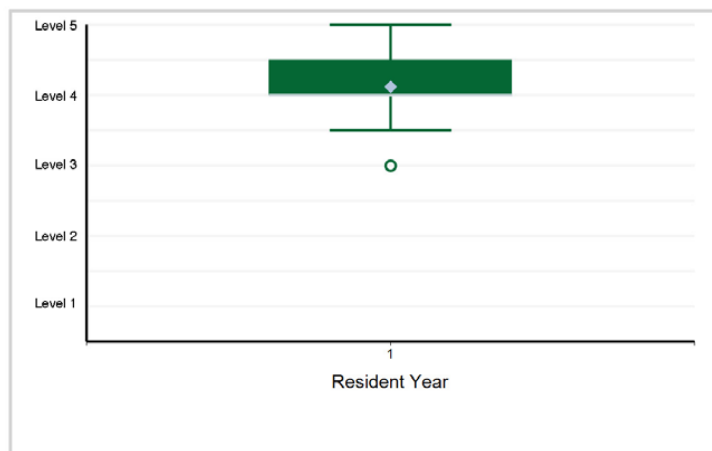

Specialty Box Plot Report - Milestone Evaluation by Resident Year: Year-End 2021-2022

SUBSPECIALTY: **Selective Pathology - Surgical**

19. Interpersonal and Communication Skills - Interpersonal and Communication Skills 3: Communication within ...

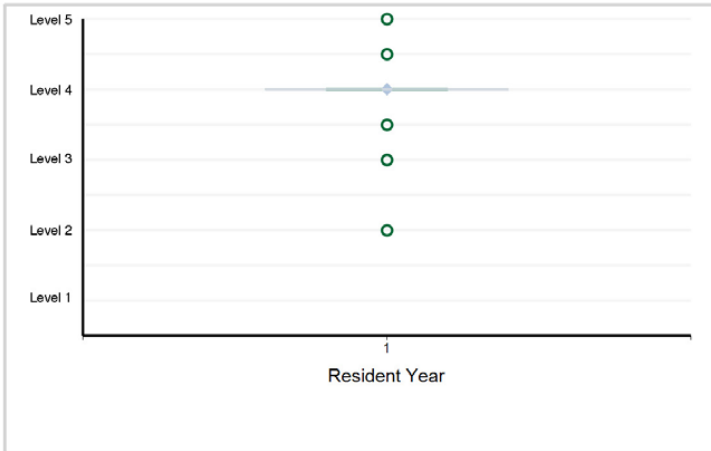

Specialty Box Plot Report - Milestone Evaluation by Resident Year: Year-End 2021-2022

TABLE 93: SPECIALTY: **Pediatrics**

Resident Year	1	2	3	Total Residents
# of Residents	3,286	3,209	3,015	9,510

1. Patient Care - Patient Care 1: History

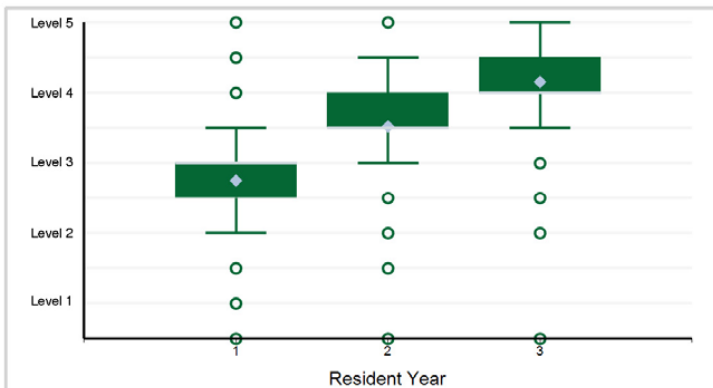

Note: 7 of 9,510 residents have a status of "Not Yet Assessable" and are not included in the analysis.

2. Patient Care - Patient Care 2: Physical Exam

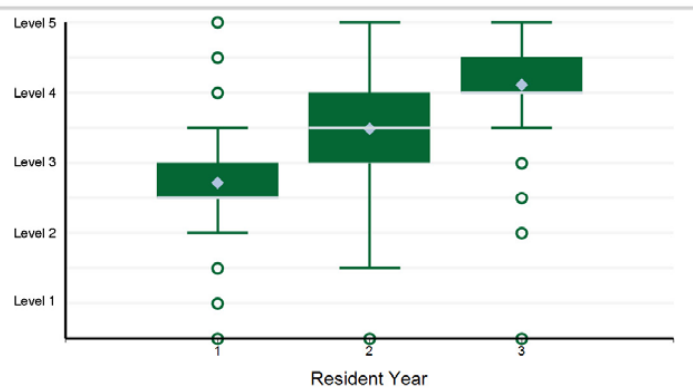

Note: 69 of 9,510 residents have a status of "Not Yet Assessable" and are not included in the analysis.

3. Patient Care - Patient Care 3: Organize and Prioritize Patient Care

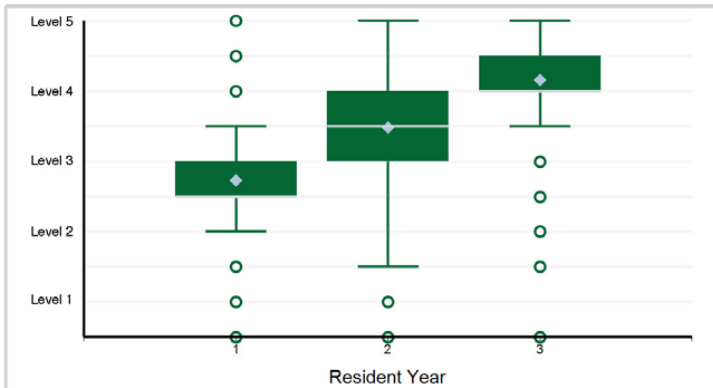

Note: 17 of 9,510 residents have a status of "Not Yet Assessable" and are not included in the analysis.

4. Patient Care - Patient Care 4: Clinical Reasoning

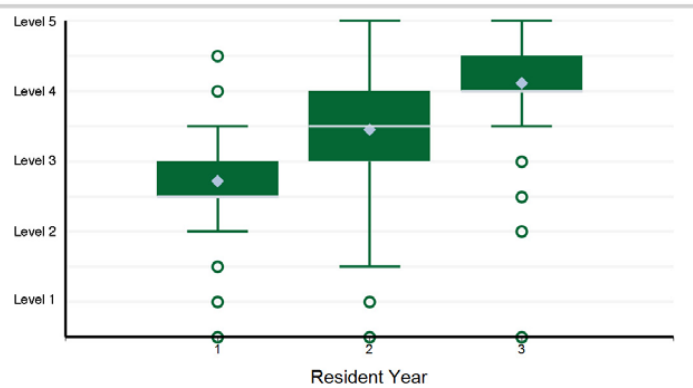

Note: 7 of 9,510 residents have a status of "Not Yet Assessable" and are not included in the analysis.

5. Patient Care - Patient Care 5: Patient Management

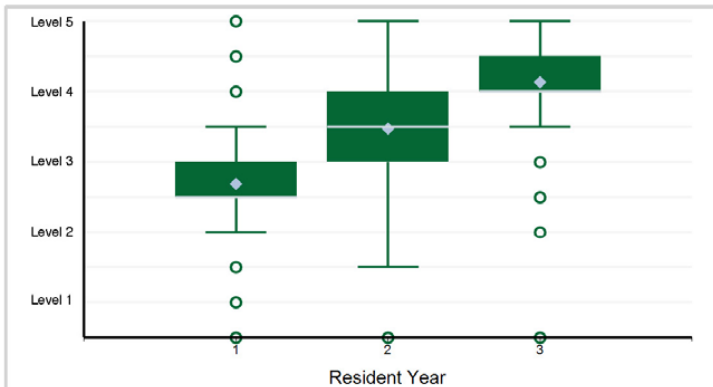

Note: 41 of 9,510 residents have a status of "Not Yet Assessable" and are not included in the analysis.

6. Medical Knowledge - Medical Knowledge 1: Clinical Knowledge

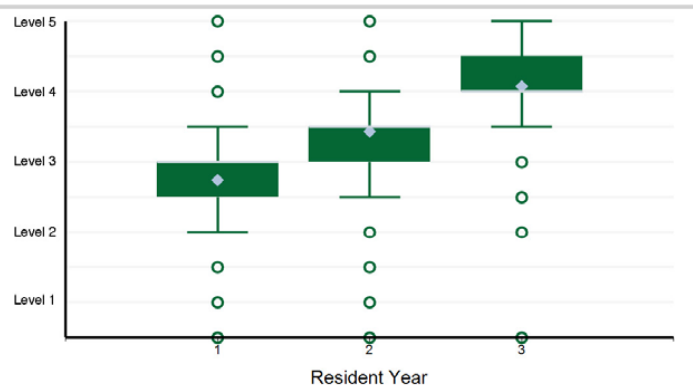

Note: 18 of 9,510 residents have a status of "Not Yet Assessable" and are not included in the analysis.

Specialty Box Plot Report - Milestone Evaluation by Resident Year: Year-End 2021-2022

SPECIALTY: **Pediatrics**

7. Medical Knowledge - Medical Knowledge 2: Diagnostic Evaluation

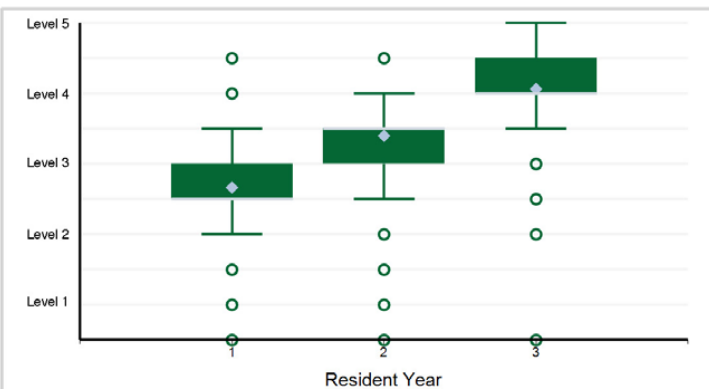

Note: 7 of 9,510 residents have a status of "Not Yet Assessable" and are not included in the analysis.

8. Systems-Based Practice - Systems-Based Practice 1: Patient Safety

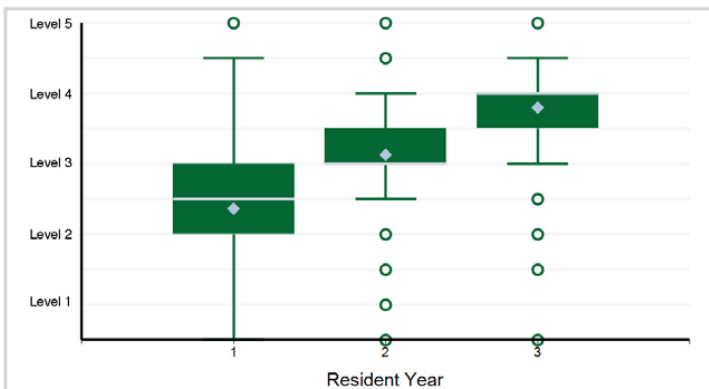

9. Systems-Based Practice - Systems-Based Practice 2: Quality Improvement

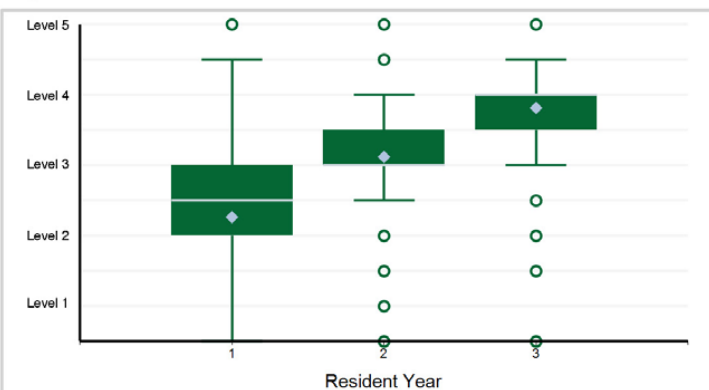

10. Systems-Based Practice - Systems-Based Practice 3: System Navigation for Patient Centered Care – Coordination of Care

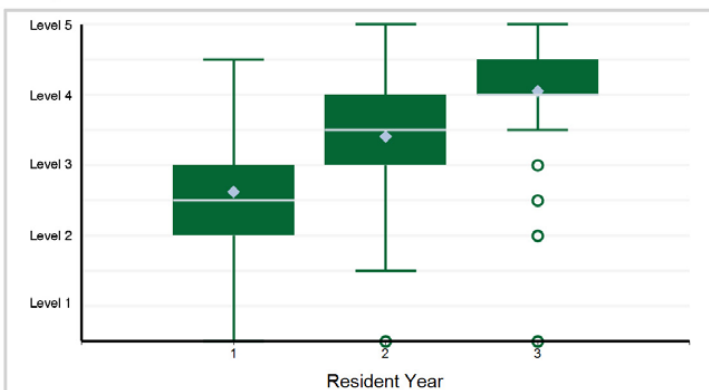

11. Systems-Based Practice - Systems-Based Practice 4: System Navigation for Patient-Centered Care – Transitions in Care

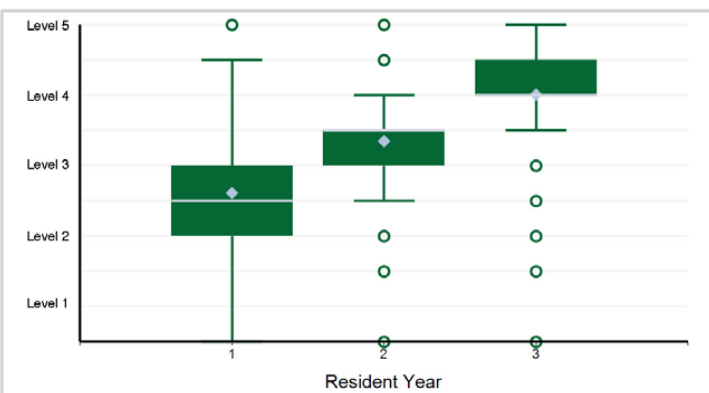

12. Systems-Based Practice - Systems-Based Practice 5: Population and Community Health

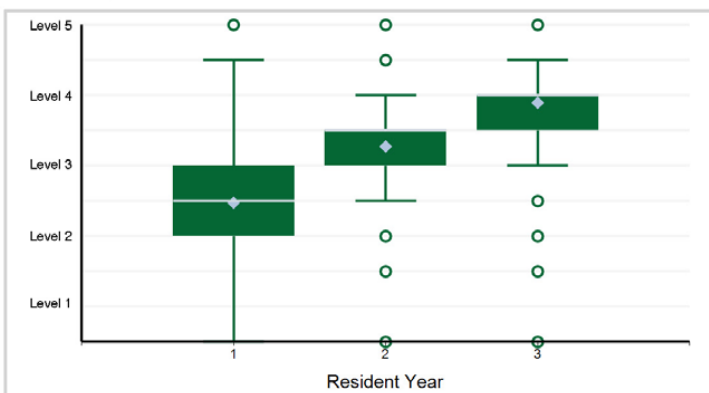

Specialty Box Plot Report - Milestone Evaluation by Resident Year: Year-End 2021-2022

SPECIALTY: Pediatrics

13. Systems-Based Practice - Systems-Based Practice 6: Physician Role in Health Care Systems

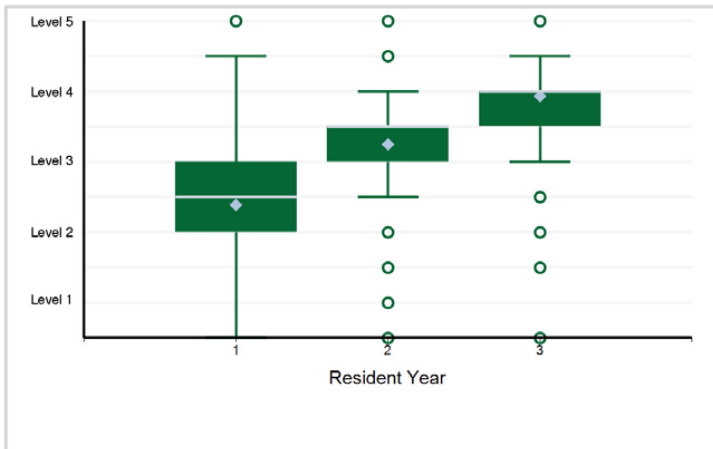

14. Practice-Based Learning and Improvement - Practice-Based Learning and Improvement 1: Evidence-Based and Informed Practice

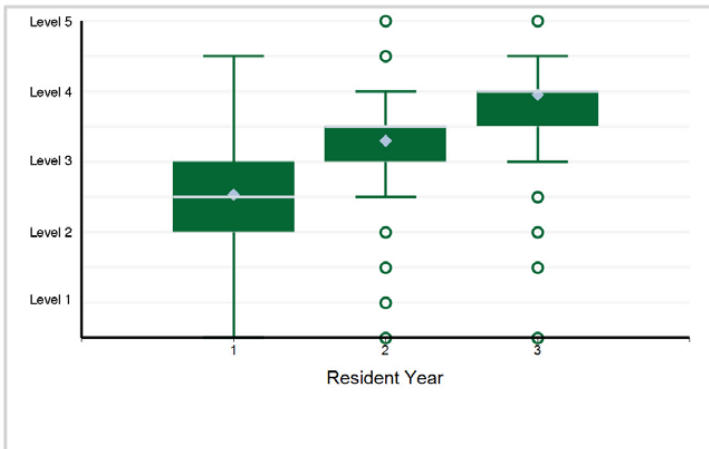

15. Practice-Based Learning and Improvement - Practice-Based Learning and Improvement 2: Reflective Practice and Commitment ...

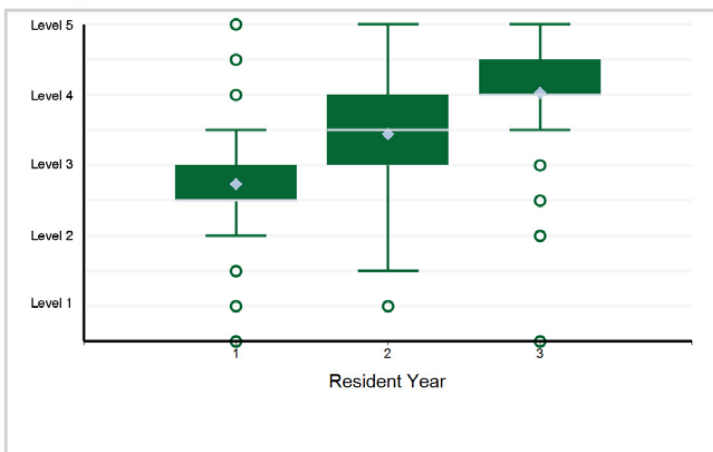

16. Professionalism - Professionalism 1: Professional Behavior

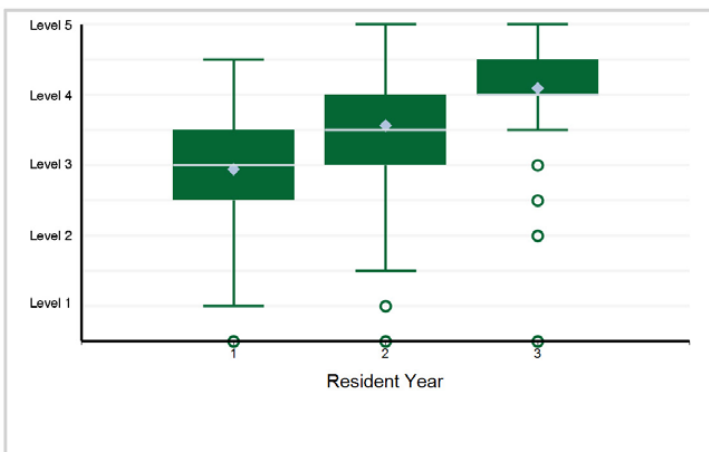

17. Professionalism - Professionalism 2: Ethical Principles

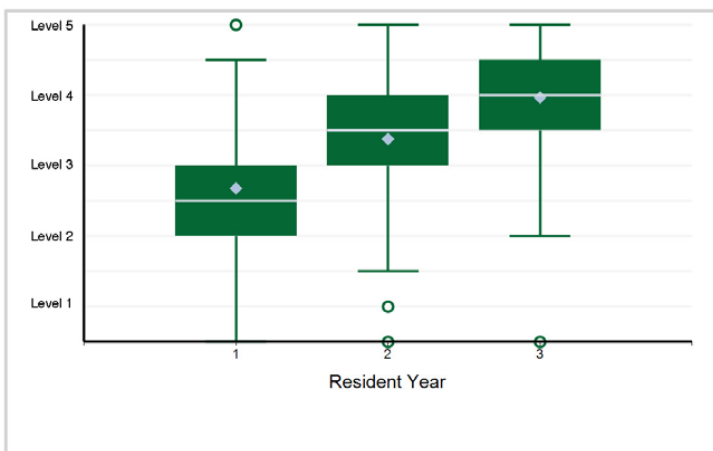

18. Professionalism - Professionalism 3: Accountability/Conscientiousness

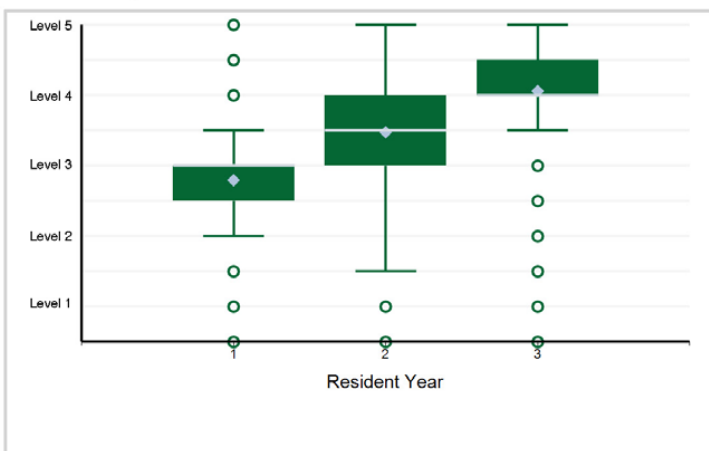

Specialty Box Plot Report - Milestone Evaluation by Resident Year: Year-End 2021-2022

SPECIALTY: **Pediatrics**

19. Professionalism - Professionalism 4: Well-Being

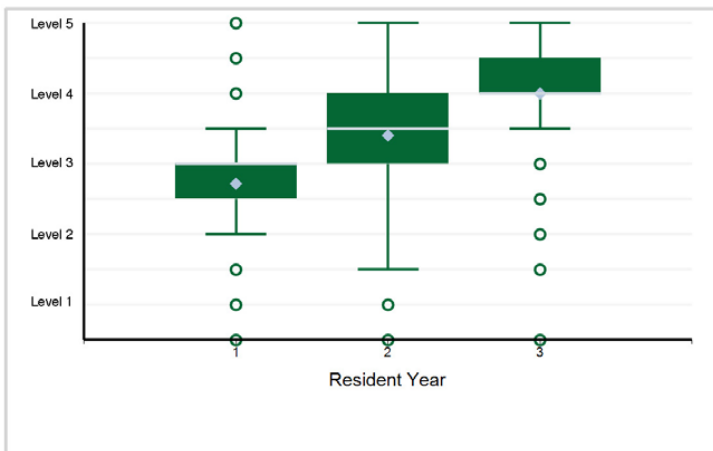

20. Interpersonal and Communication Skills - Interpersonal and Communication Skills 1: Patient- and Family-Centered Communication

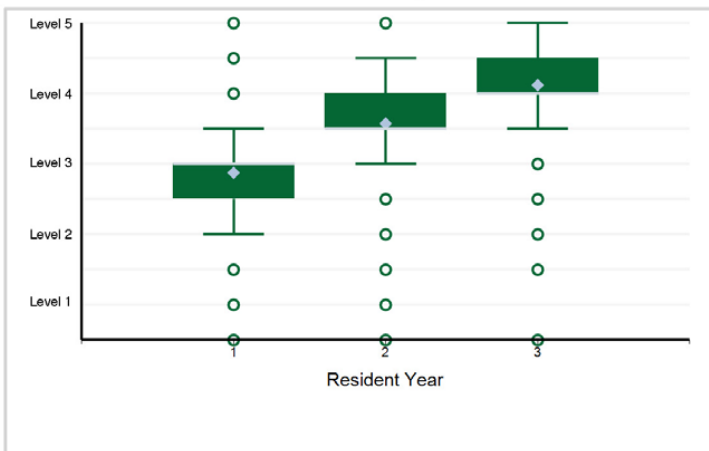

21. Interpersonal and Communication Skills - Interpersonal and Communication Skills 2: Interprofessional and Team Communication

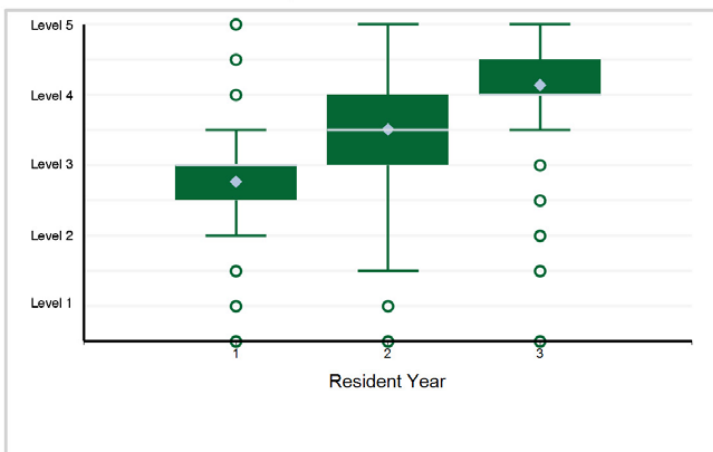

22. Interpersonal and Communication Skills - Interpersonal and Communication Skills 3: Communication within Health Care Systems

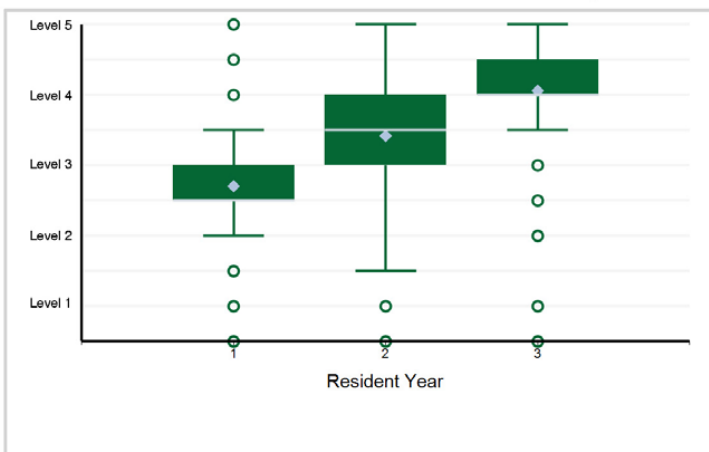

Specialty Box Plot Report - Milestone Evaluation by Resident Year: Year-End 2021-2022

TABLE 94: SUBSPECIALTY: **Adolescent Medicine**

Resident Year	1	2	3	Total Residents
# of Residents	28	32	33	93

1. Patient Care - PC1. Provide transfer of care that ensures seamless transitions

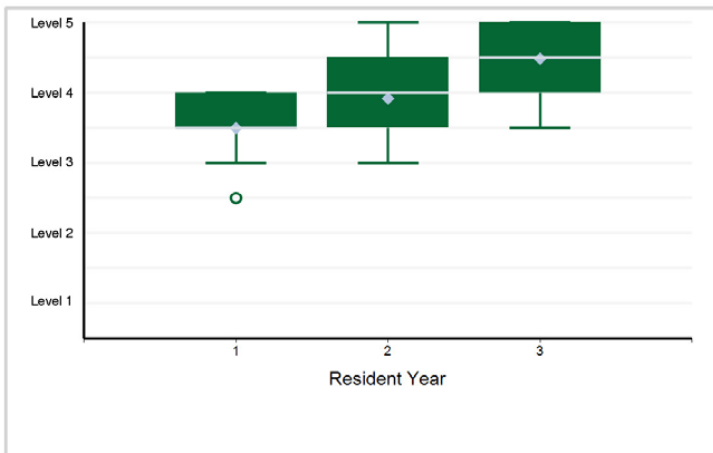

2. Patient Care - PC2. Make informed diagnostic and therapeutic decisions that result in optimal clinical judgment

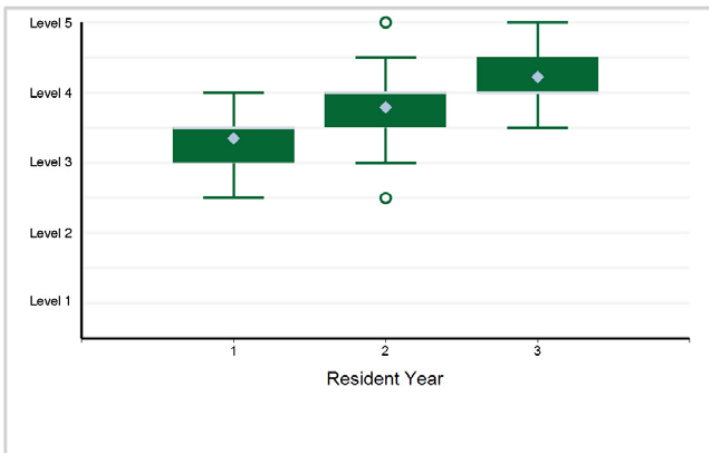

3. Patient Care - PC3. Develop and carry out management plans

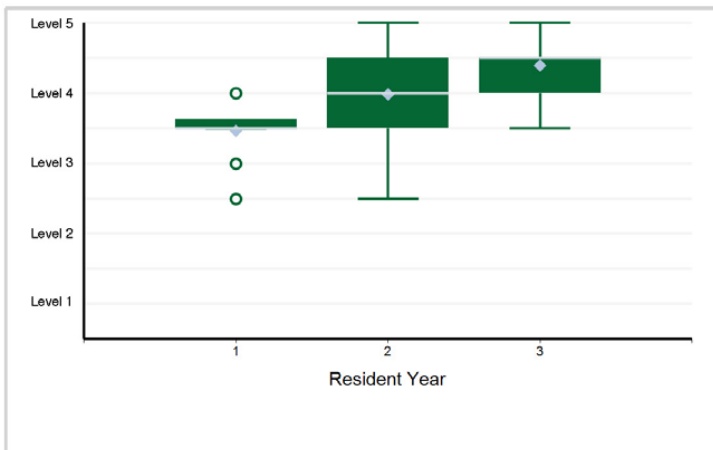

4. Patient Care - PC4. Provide appropriate role modeling

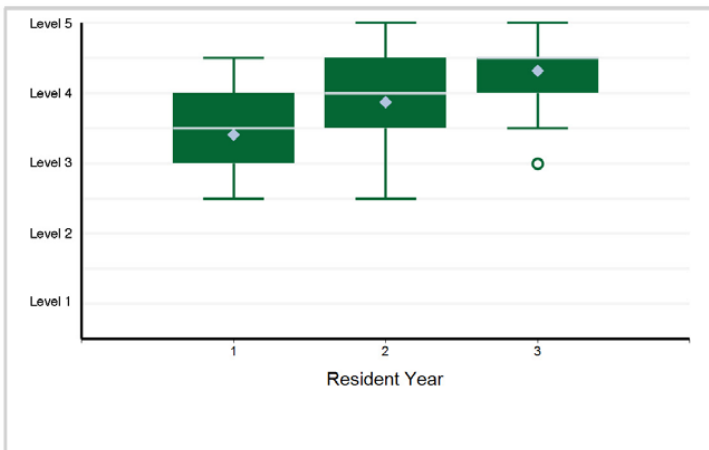

5. Medical Knowledge - MK1. Locate, appraise, and assimilate evidence from scientific studies related to ...

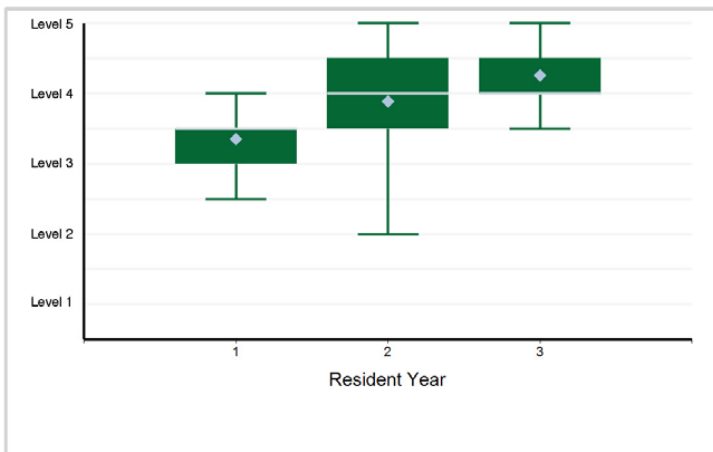

6. Systems-Based Practice - SBP1. Work effectively in various health care delivery settings and systems ...

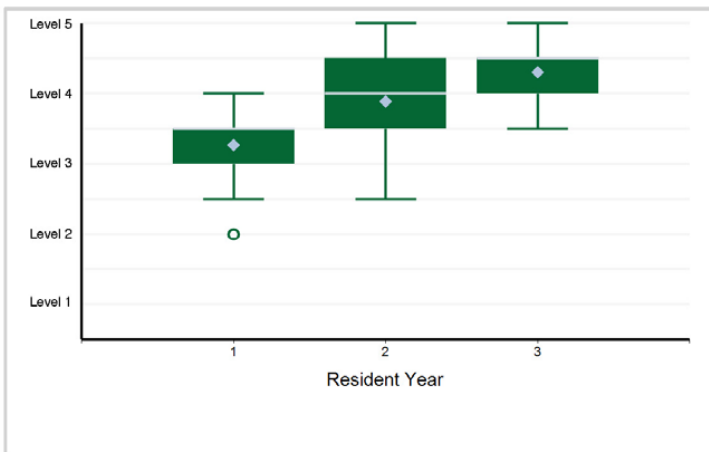

Specialty Box Plot Report - Milestone Evaluation by Resident Year: Year-End 2021-2022

SUBSPECIALTY: Adolescent Medicine

7. Systems-Based Practice - SBP2. Coordinate patient care within the health care system relevant to their clinical specialty

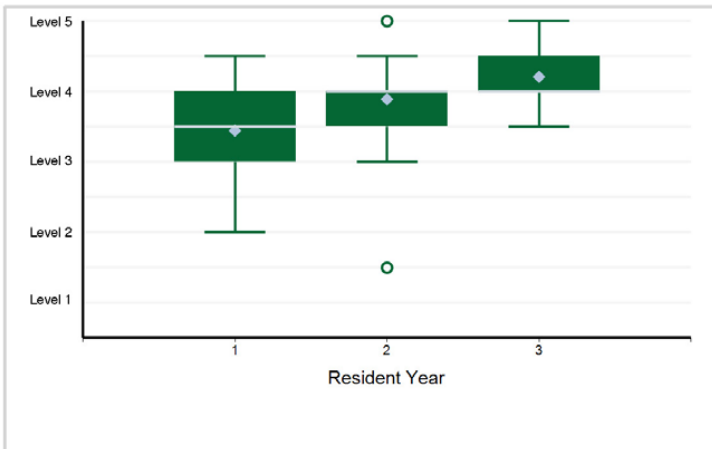

8. Systems-Based Practice - SBP3. Incorporate considerations of cost awareness and risk-benefit analysis in patient and/or ...

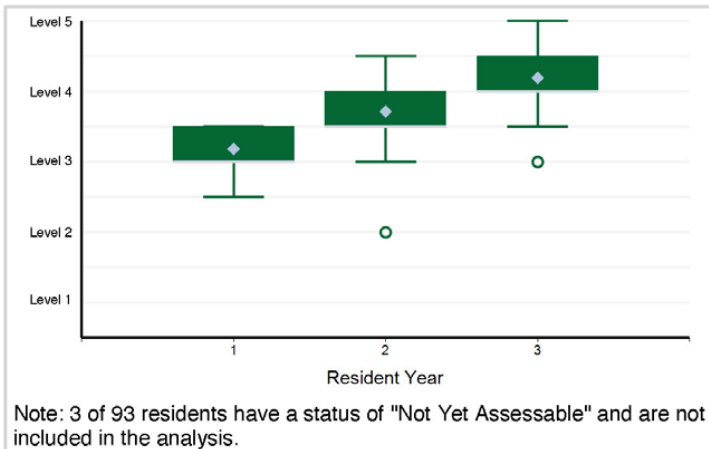

9. Systems-Based Practice - SBP4. Work in interprofessional teams to enhance patient safety and improve patient care quality

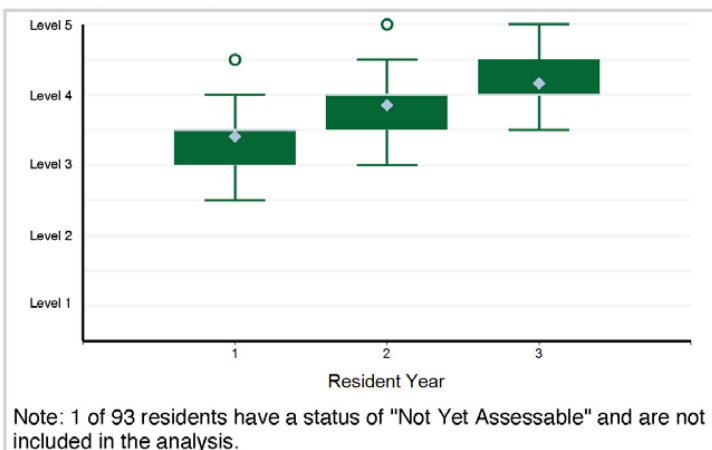

10. Systems-Based Practice - SBP5. Participate in identifying system errors and implementing potential systems solutions

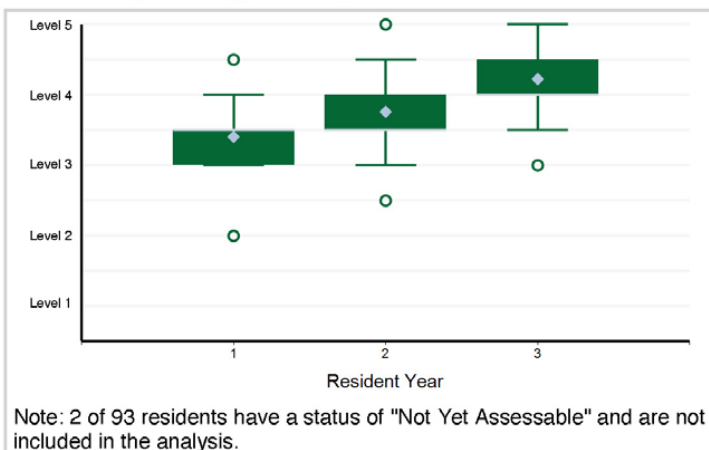

11. Practice-Based Learning and Improvement - PBLI1. Identify strengths, deficiencies, and limits in one's knowledge and expertise

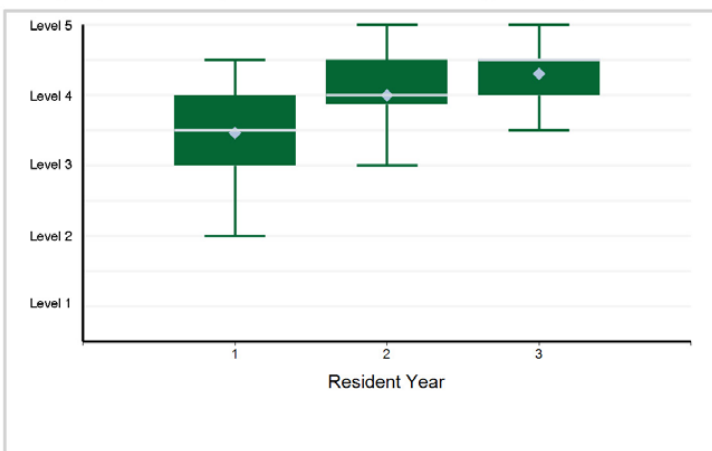

12. Practice-Based Learning and Improvement - PBLI2. Systematically analyze practice using quality improvement methods, and ...

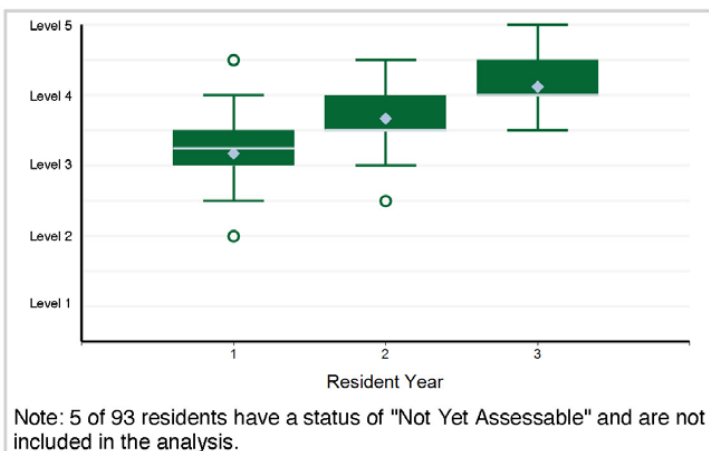

Specialty Box Plot Report - Milestone Evaluation by Resident Year: Year-End 2021-2022

SUBSPECIALTY: Adolescent Medicine

13. Practice-Based Learning and Improvement - PBLI3. Use information technology to optimize learning and care delivery

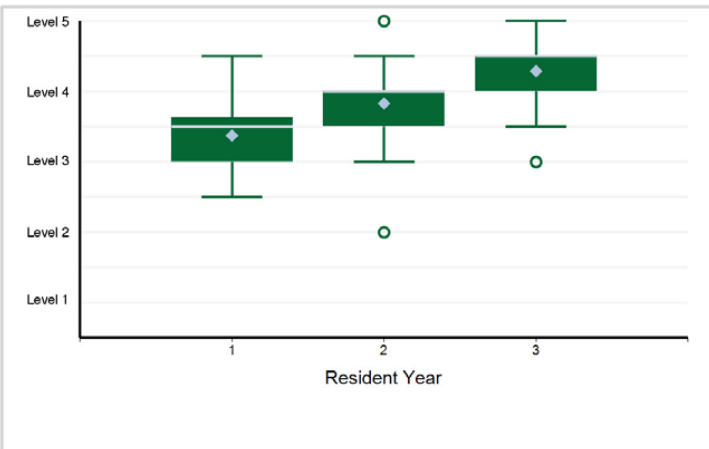

14. Practice-Based Learning and Improvement - PBLI4. Participate in the education of patients, families, ...

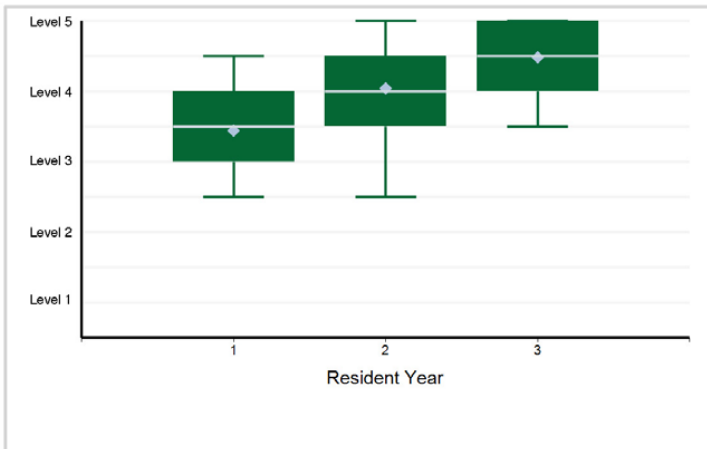

15. Professionalism - PROF1. Professional Conduct: High standards of ethical behavior which includes maintaining ...

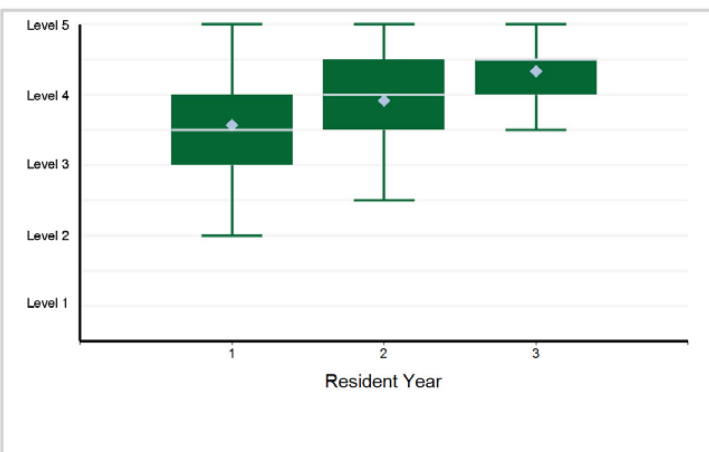

16. Professionalism - PROF2. Trustworthiness that makes colleagues feel secure when one is responsible for the care of patients

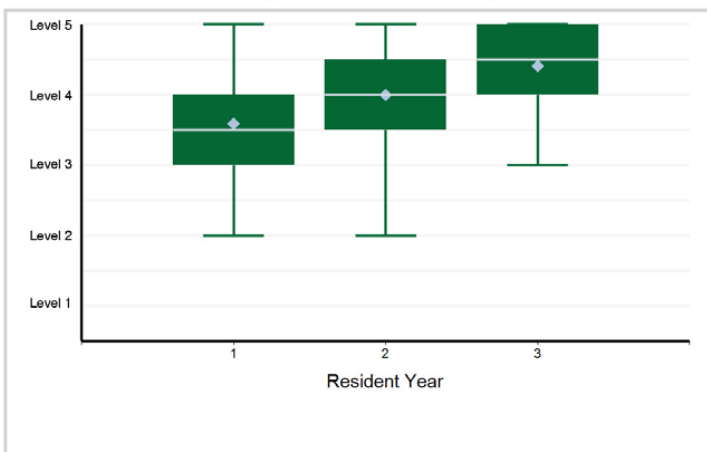

17. Professionalism - PROF3. Provide leadership skills that enhance team functioning, the learning environment, ...

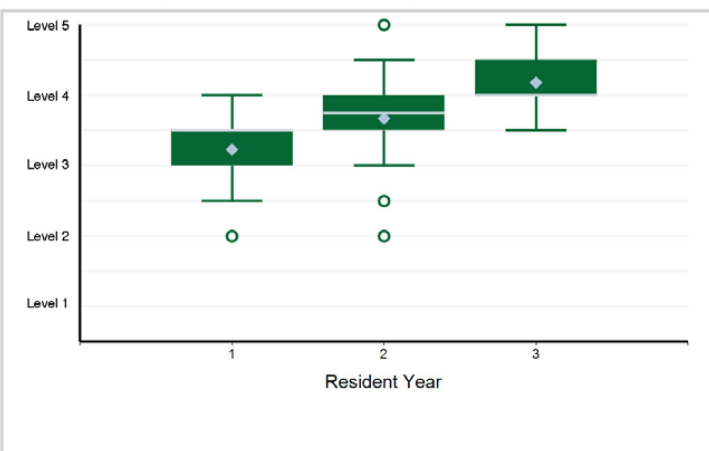

18. Professionalism - PROF4. The capacity to accept that ambiguity is part of clinical medicine and to recognize ...

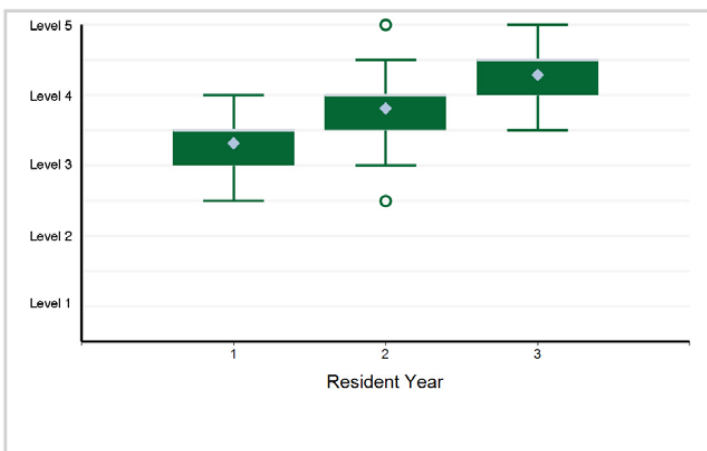

Specialty Box Plot Report - Milestone Evaluation by Resident Year: Year-End 2021-2022

SUBSPECIALTY: Adolescent Medicine

19. Interpersonal and Communication Skills - ICS1. Communicate effectively with physicians, other health professionals, and ...

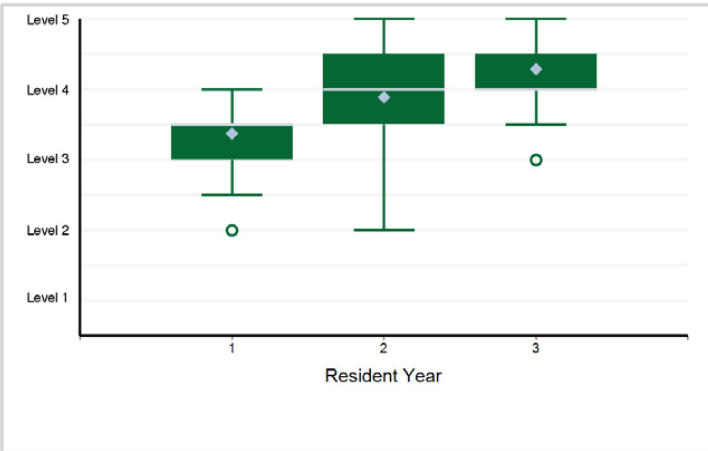

20. Interpersonal and Communication Skills - ICS2. Work effectively as a member or leader of a health care ...

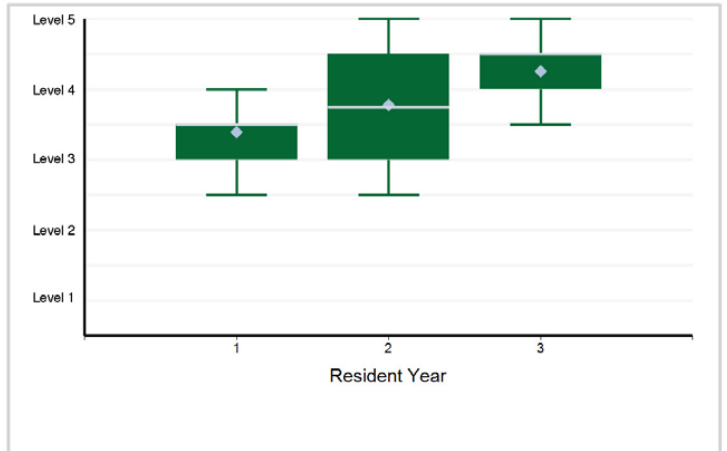

21. Interpersonal and Communication Skills - ICS3. Act in a consultative role to other physicians and health professionals

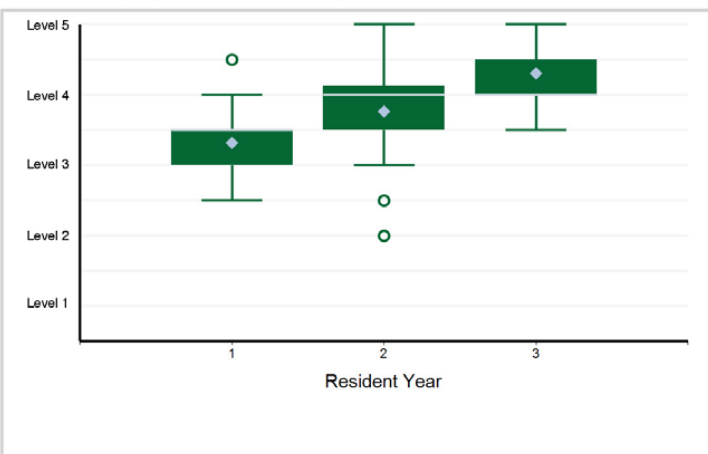

Specialty Box Plot Report - Milestone Evaluation by Resident Year: Year-End 2021-2022

TABLE 95: SUBSPECIALTY: **Child Abuse Pediatrics**

Resident Year	1	2	3	Total Residents
# of Residents	22	14	14	50

1. Patient Care - PC1. Provide transfer of care that ensures seamless transitions

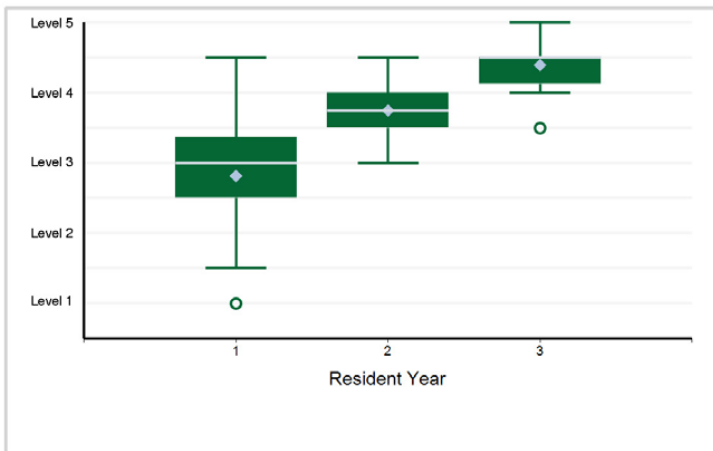

2. Patient Care - PC2. Make informed diagnostic and therapeutic decisions that result in optimal clinical judgment

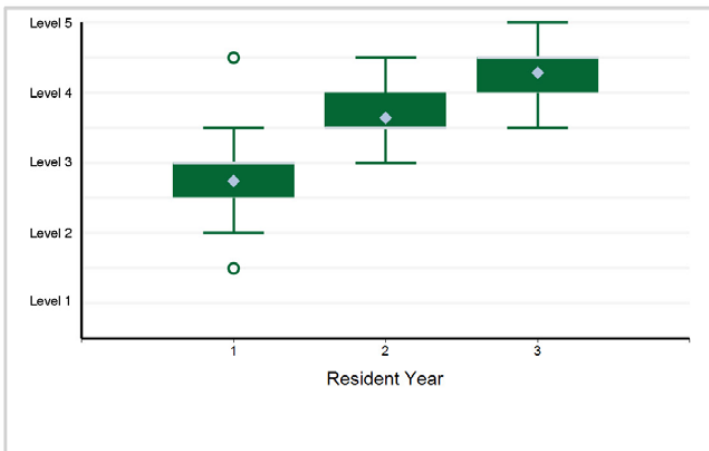

3. Patient Care - PC3. Develop and carry out management plans

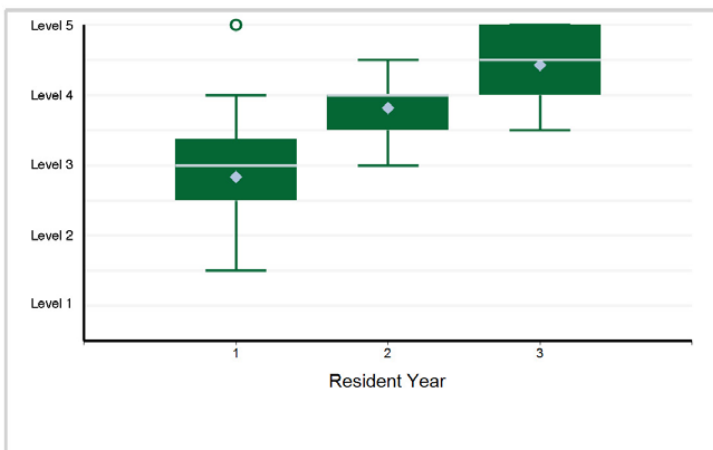

4. Patient Care - PC4. Provide appropriate role modeling

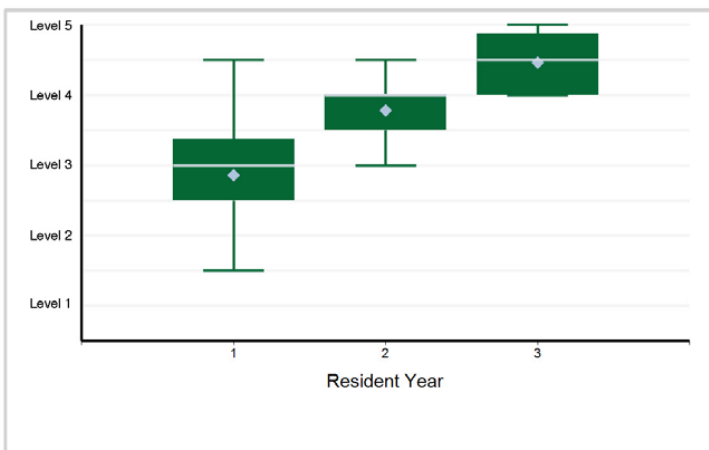

5. Medical Knowledge - MK1. Locate, appraise, and assimilate evidence from scientific studies related to ...

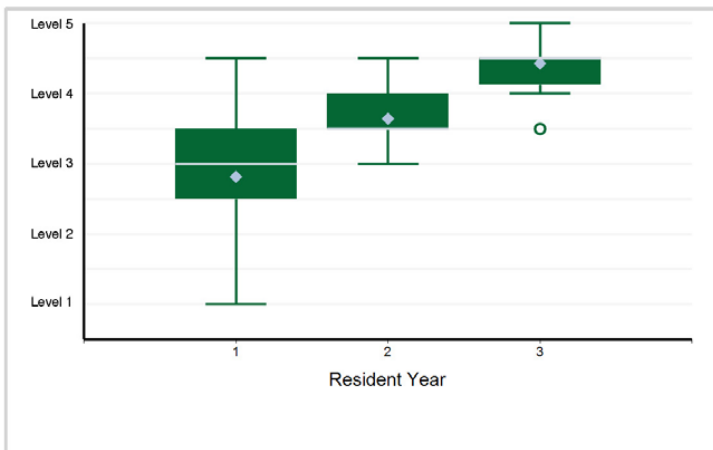

6. Systems-Based Practice - SBP1. Work effectively in various health care delivery settings and systems ...

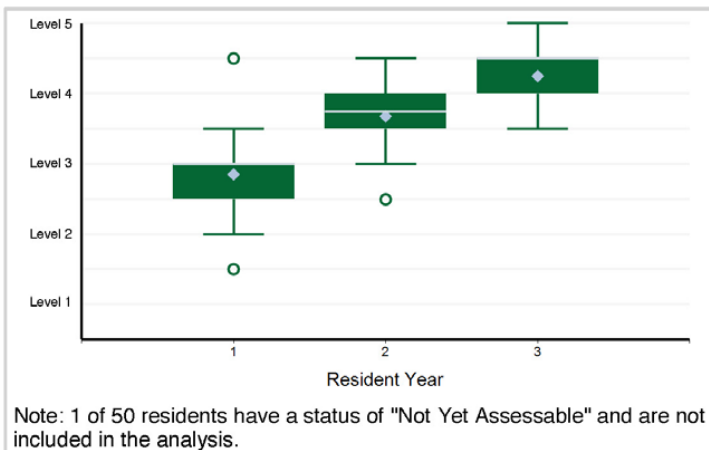

Note: 1 of 50 residents have a status of "Not Yet Assessable" and are not included in the analysis.

Specialty Box Plot Report - Milestone Evaluation by Resident Year: Year-End 2021-2022

SUBSPECIALTY: Child Abuse Pediatrics

7. Systems-Based Practice - SBP2. Coordinate patient care within the health care system relevant to their clinical specialty

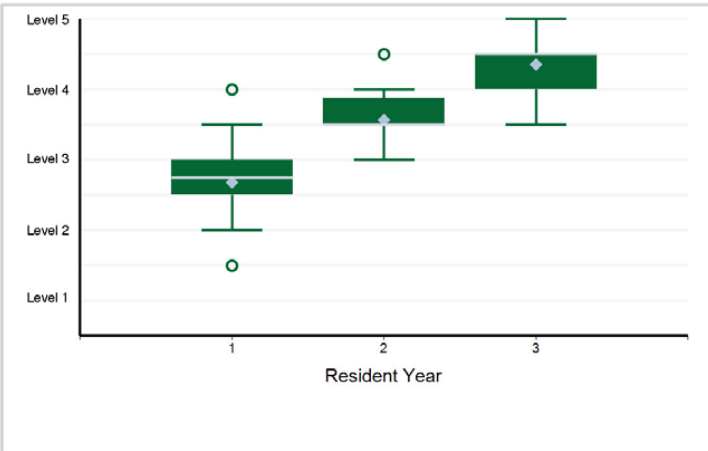

8. Systems-Based Practice - SBP3. Incorporate considerations of cost awareness and risk-benefit analysis in patient and/or ...

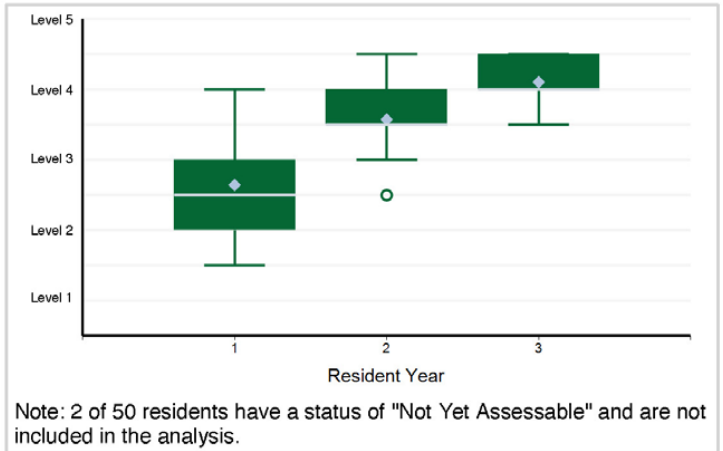

9. Systems-Based Practice - SBP4. Work in interprofessional teams to enhance patient safety and improve patient care quality

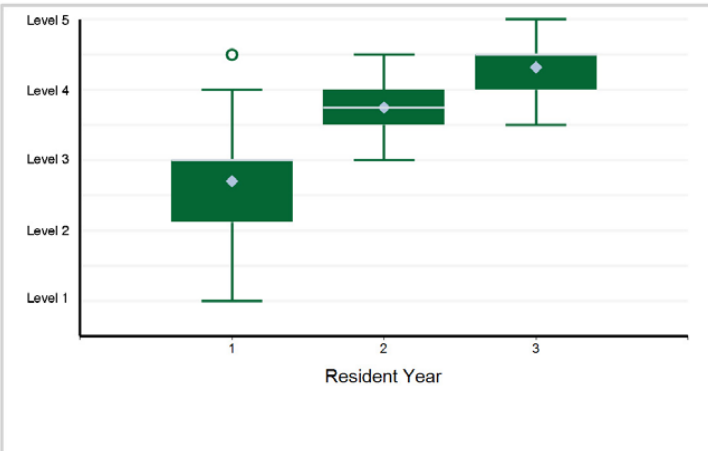

10. Systems-Based Practice - SBP5. Participate in identifying system errors and implementing potential systems solutions

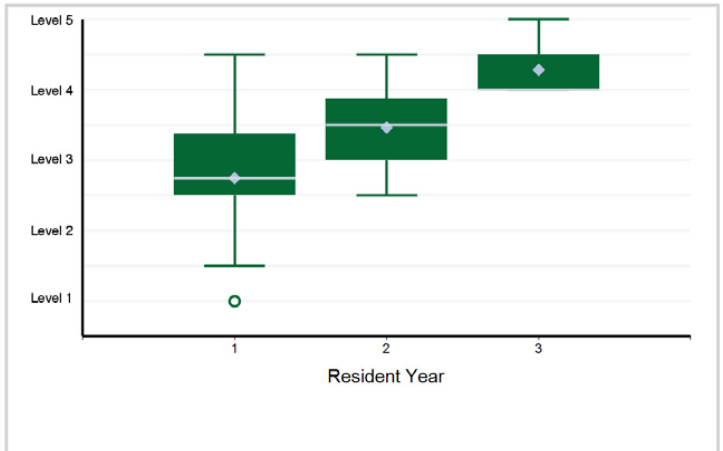

11. Practice-Based Learning and Improvement - PBLI1. Identify strengths, deficiencies, and limits in one's knowledge and expertise

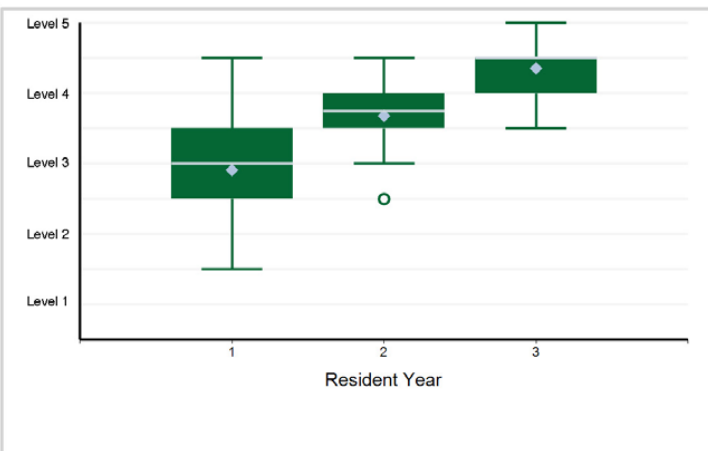

12. Practice-Based Learning and Improvement - PBLI2. Systematically analyze practice using quality improvement methods, and ...

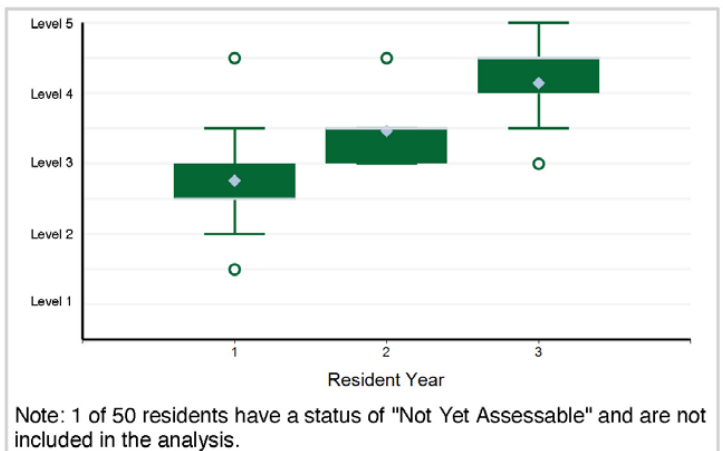

Specialty Box Plot Report - Milestone Evaluation by Resident Year: Year-End 2021-2022

SUBSPECIALTY: Child Abuse Pediatrics

13. Practice-Based Learning and Improvement - PBLI3. Use information technology to optimize learning and care delivery

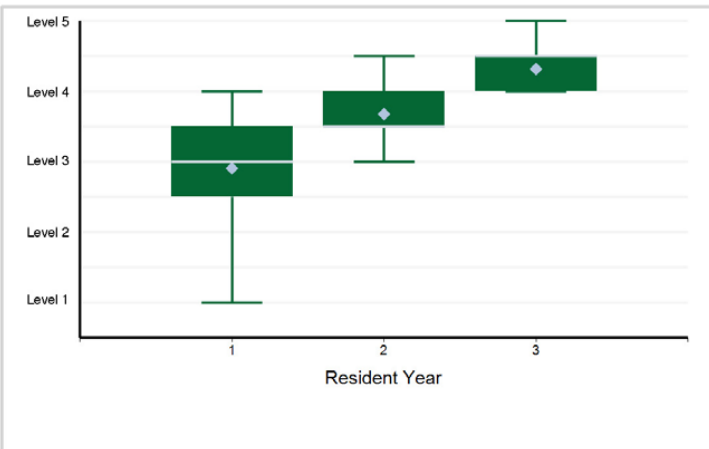

14. Practice-Based Learning and Improvement - PBLI4. Participate in the education of patients, families, ...

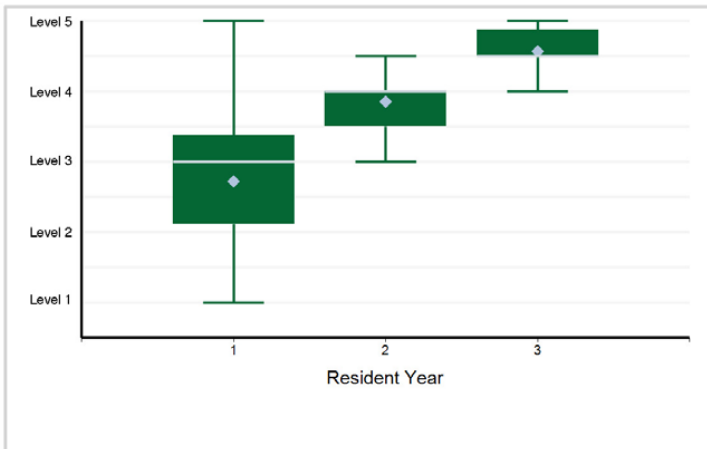

15. Professionalism - PROF1. Professional Conduct: High standards of ethical behavior which includes maintaining ...

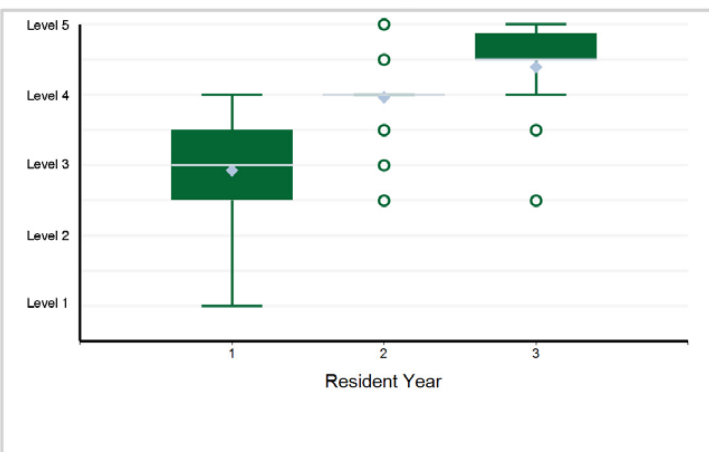

16. Professionalism - PROF2. Trustworthiness that makes colleagues feel secure when one is responsible for the care of patients

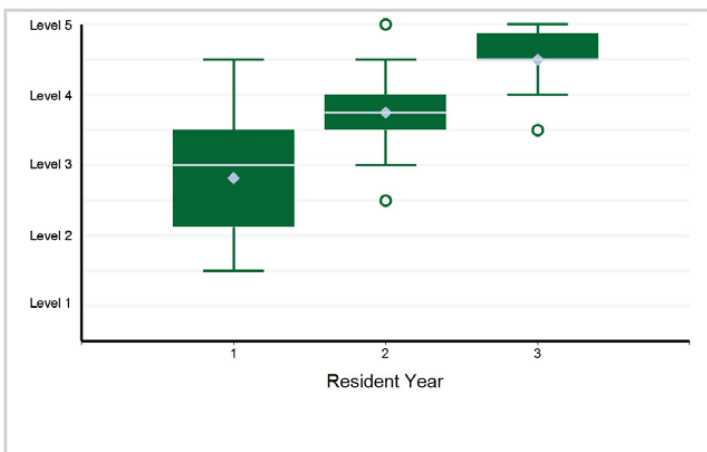

17. Professionalism - PROF3. Provide leadership skills that enhance team functioning, the learning environment, ...

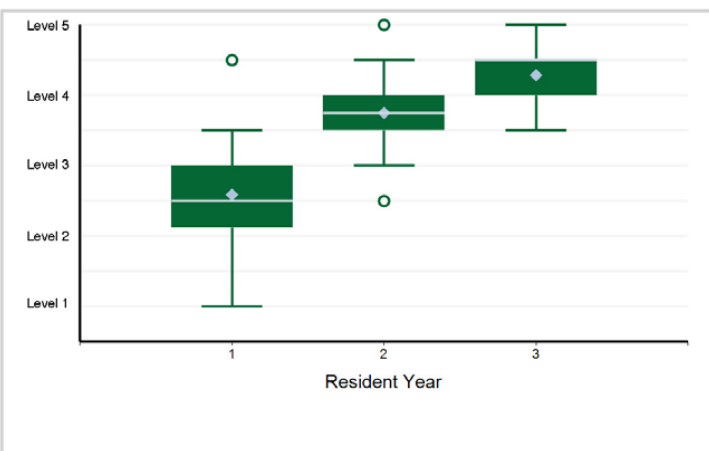

18. Professionalism - PROF4. The capacity to accept that ambiguity is part of clinical medicine and to recognize ...

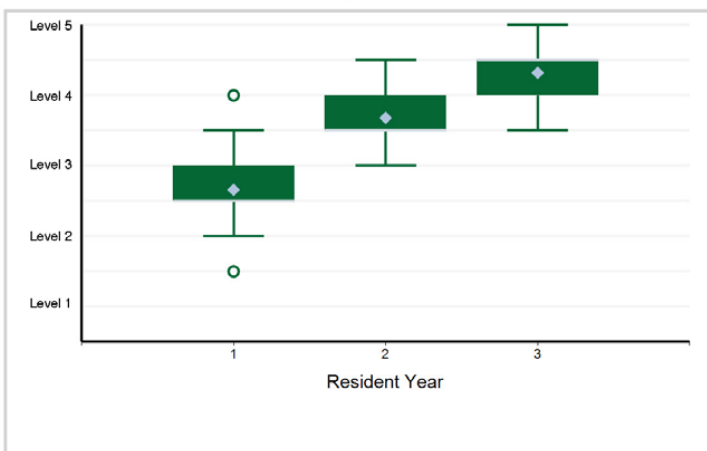

Specialty Box Plot Report - Milestone Evaluation by Resident Year: Year-End 2021-2022

SUBSPECIALTY: Child Abuse Pediatrics

19. Interpersonal and Communication Skills - ICS1. Communicate effectively with physicians, other health professionals, and ...

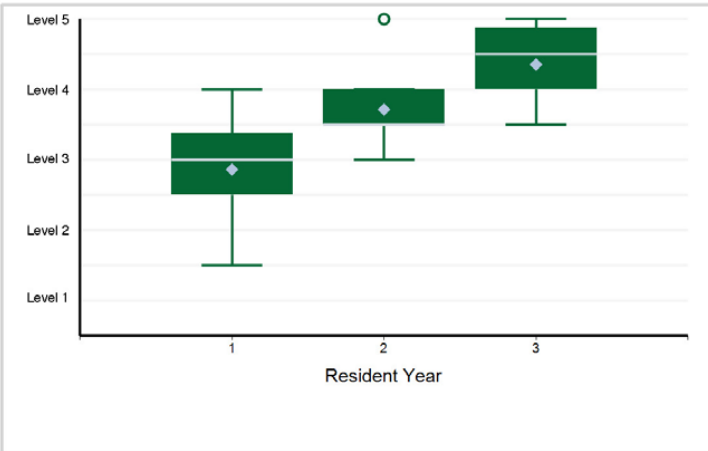

20. Interpersonal and Communication Skills - ICS2. Work effectively as a member or leader of a health care ...

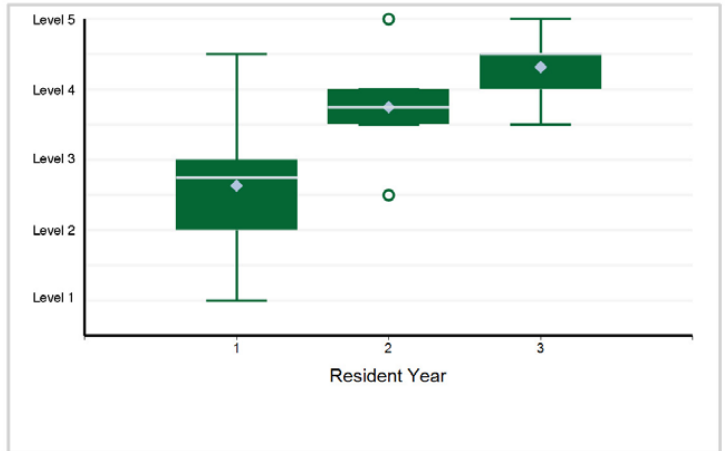

21. Interpersonal and Communication Skills - ICS3. Act in a consultative role to other physicians and health professionals

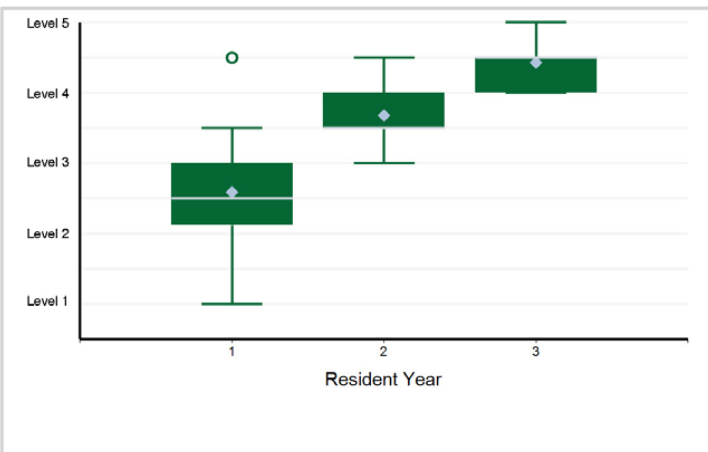

Specialty Box Plot Report - Milestone Evaluation by Resident Year: Year-End 2021-2022

TABLE 96: SUBSPECIALTY: **Clinical Informatics (multidisciplinary, Pediatrics)**

Resident Year	1	2	Total Residents
# of Residents	15	14	29

1. Patient Care - Patient Care 1: Technology Assessment

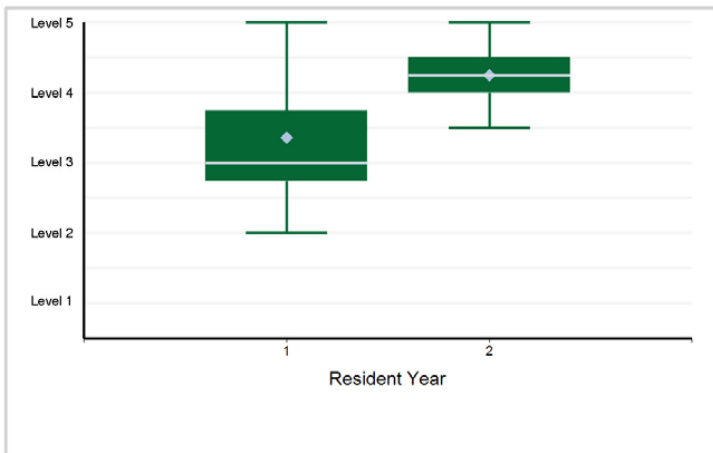

2. Patient Care - Patient Care 2: Clinical Decision Support Systems

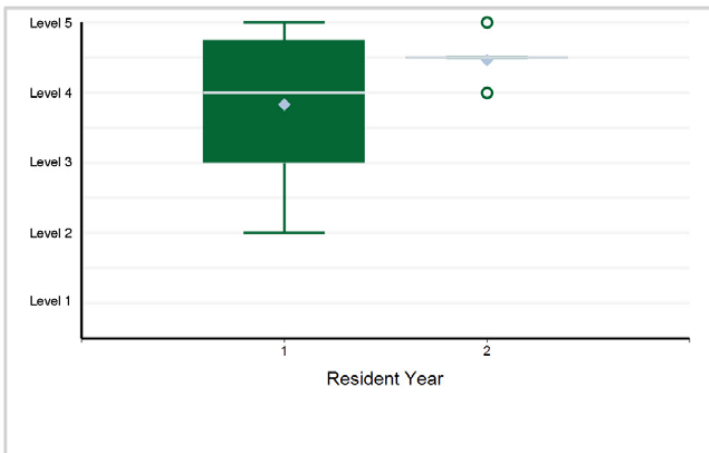

3. Patient Care - Patient Care 3: Impact of Clinical Informatics on Patient Care

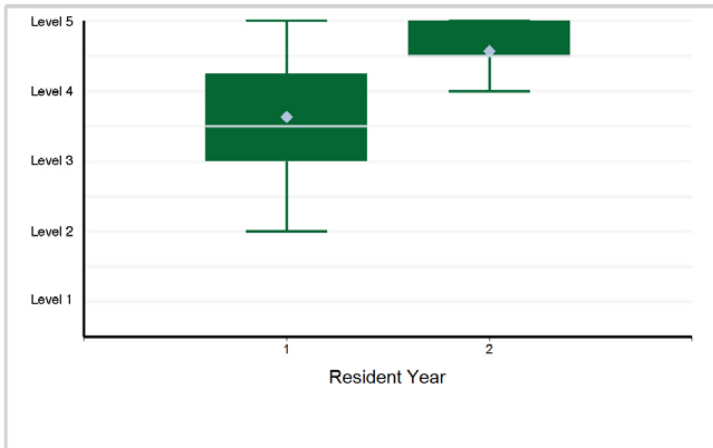

4. Patient Care - Patient Care 4: Project Management

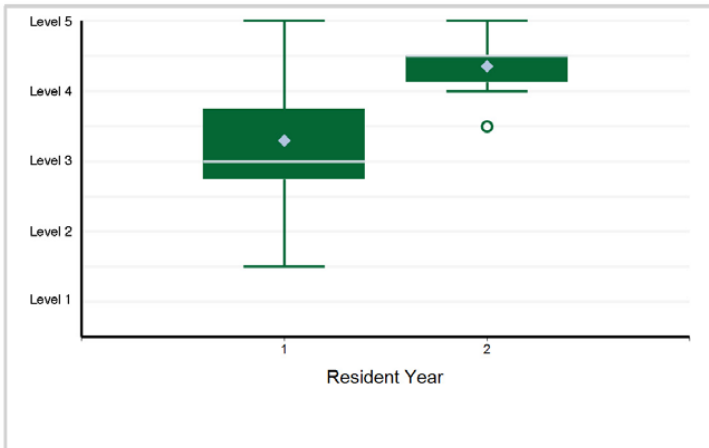

5. Patient Care - Patient Care 5: Information System Lifecycle

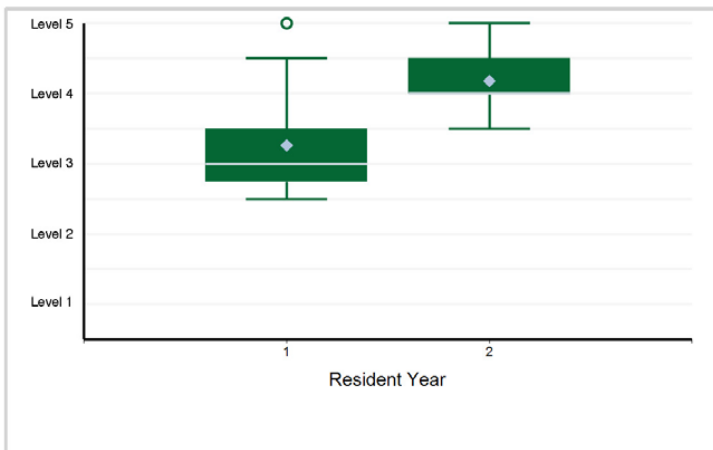

6. Patient Care - Patient Care 6: Assessing User Needs

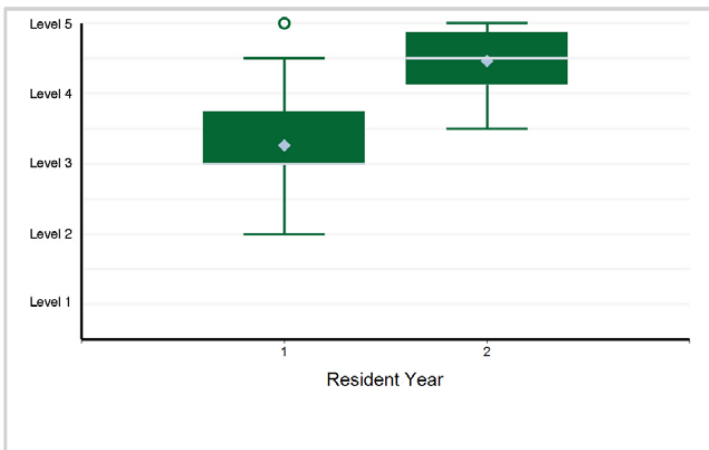

Specialty Box Plot Report - Milestone Evaluation by Resident Year: Year-End 2021-2022

SUBSPECIALTY: Clinical Informatics (multidisciplinary, Pediatrics)

7. Medical Knowledge - Medical Knowledge 1: Clinical Informatics Fundamentals and Programming

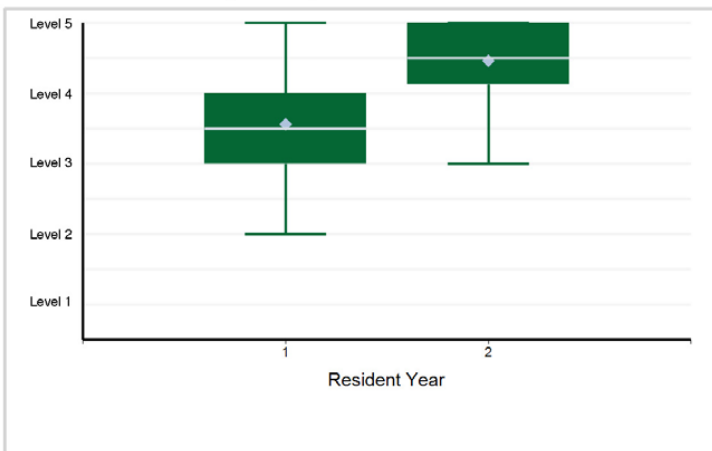

8. Medical Knowledge - Medical Knowledge 2: Leadership and Change Management

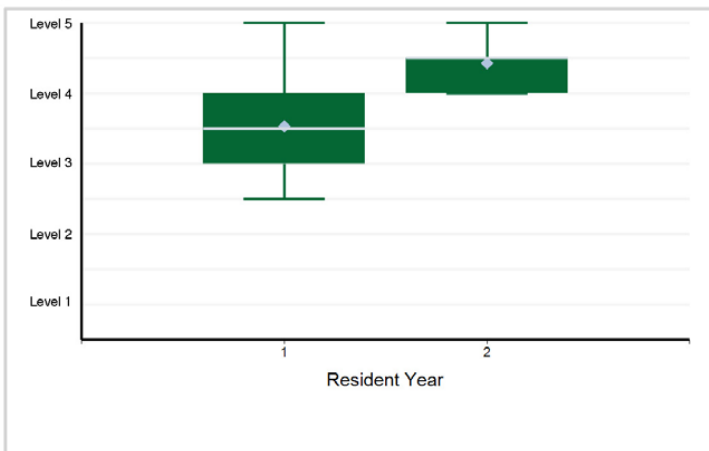

9. Systems-Based Practice - Systems-Based Practice 1: Patient Safety and Unintended Consequences

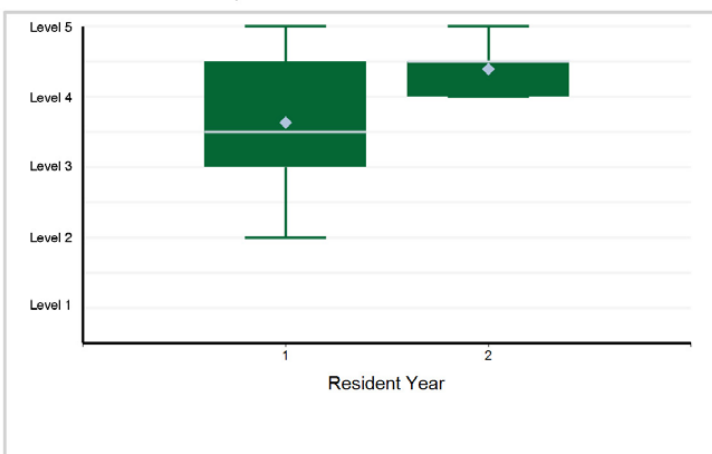

10. Systems-Based Practice - Systems-Based Practice 2: Resource Utilization

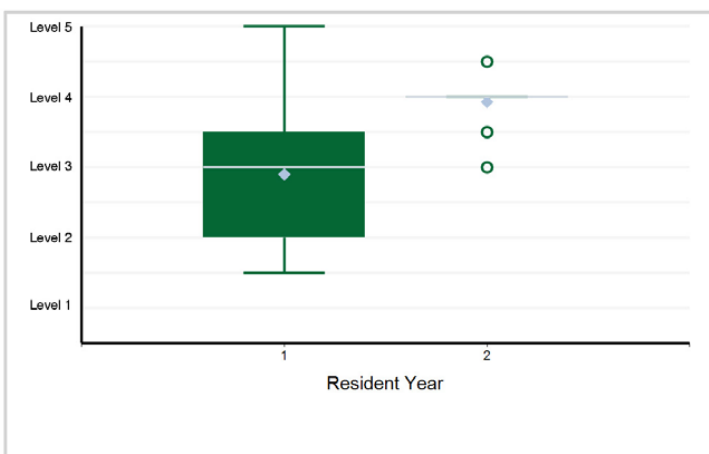

11. Systems-Based Practice - Systems-Based Practice 3: Workflow and Data Warehouse/Repository

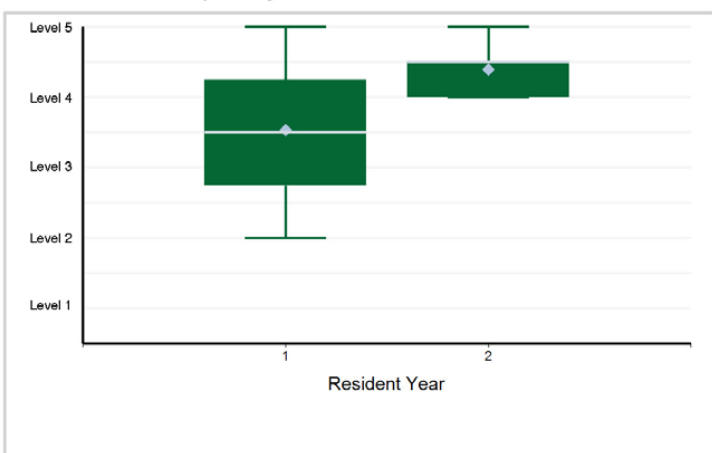

12. Practice-Based Learning and Improvement - Practice-Based Learning and Improvement 1: Recognition of ...

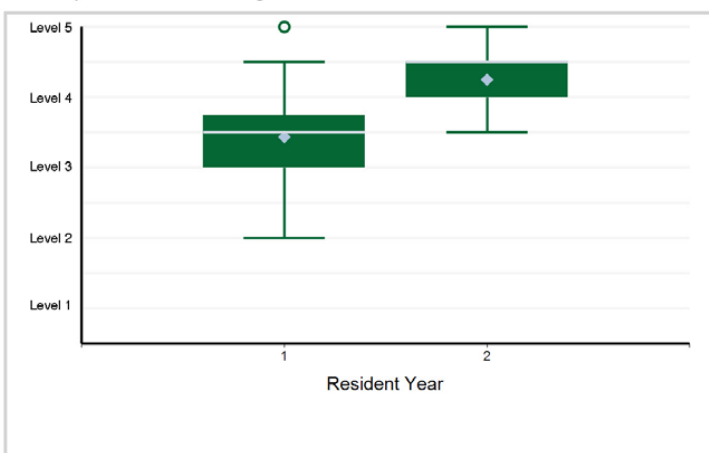

Specialty Box Plot Report - Milestone Evaluation by Resident Year: Year-End 2021-2022

SUBSPECIALTY: Clinical Informatics (multidisciplinary, Pediatrics)

13. Practice-Based Learning and Improvement - Practice-Based Learning and Improvement 2: Scholarly Activity ...

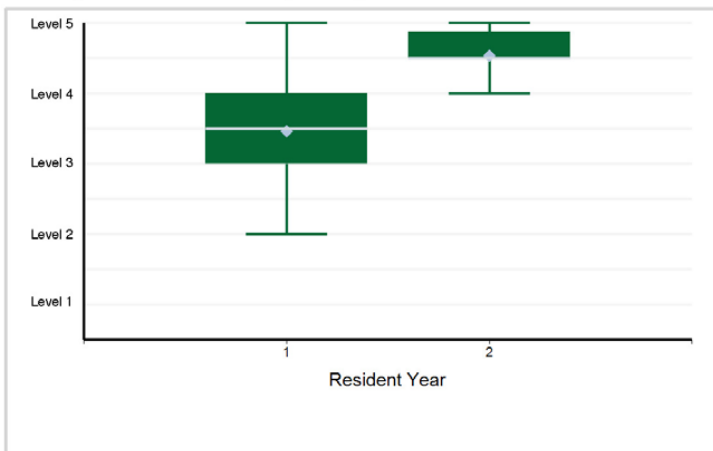

14. Professionalism - Professionalism 1: Professionalism — Demonstrates honesty, integrity, and ethical behavior

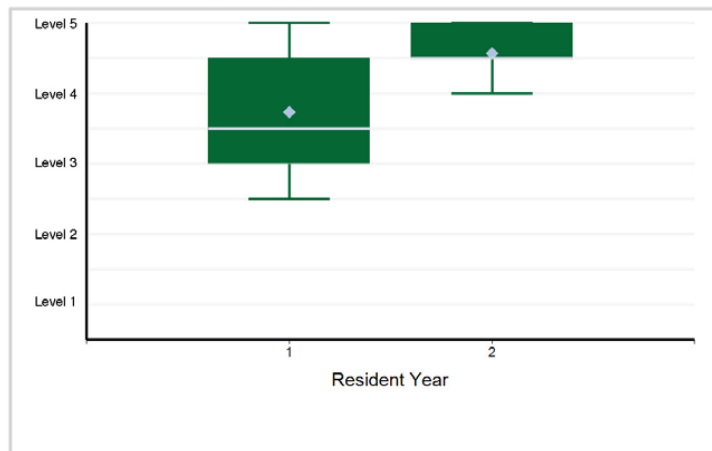

15. Professionalism - Professionalism 2: Professionalism — Demonstrates responsibility and follow-through on tasks

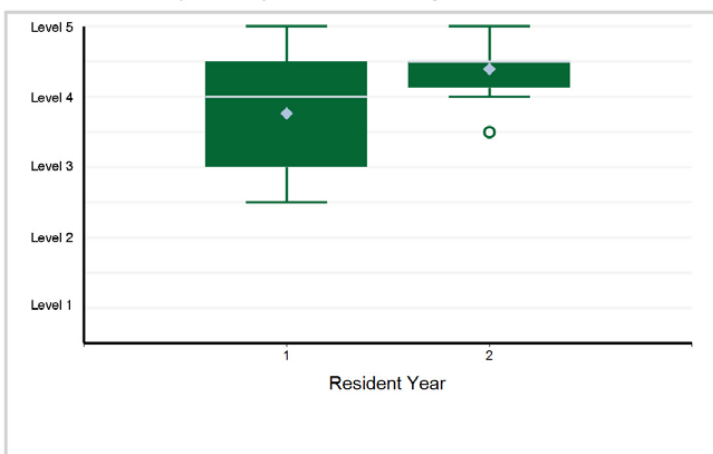

16. Professionalism - Professionalism 3: Professionalism — Gives and receives feedback

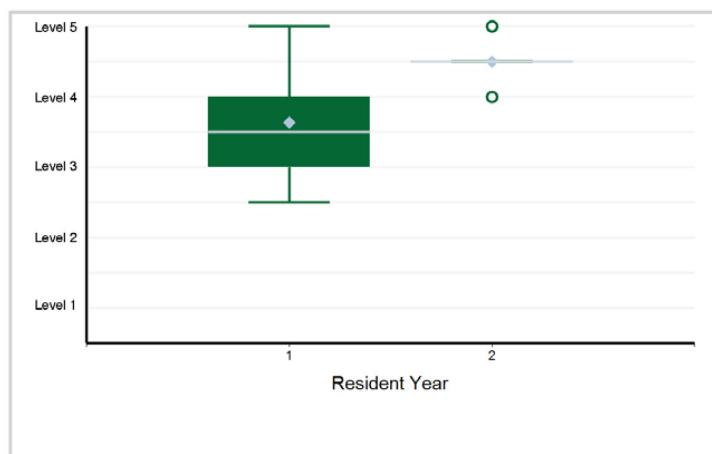

17. Professionalism - Professionalism 4: Professionalism — Demonstrates responsiveness and sensitivity to ...

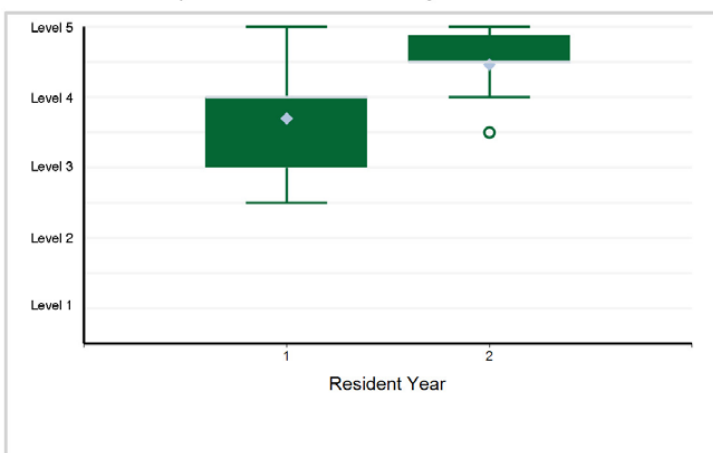

18. Professionalism - Professionalism 5: Professionalism — Understands and practices information security and privacy

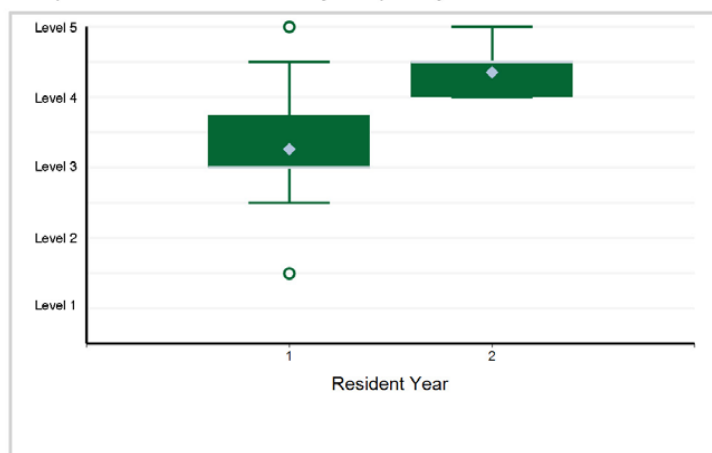

Specialty Box Plot Report - Milestone Evaluation by Resident Year: Year-End 2021-2022

SUBSPECIALTY: **Clinical Informatics (multidisciplinary, Pediatrics)**

19. Interpersonal and Communication Skills - Interpersonal and Communication Skills 1: Effective Communications ...

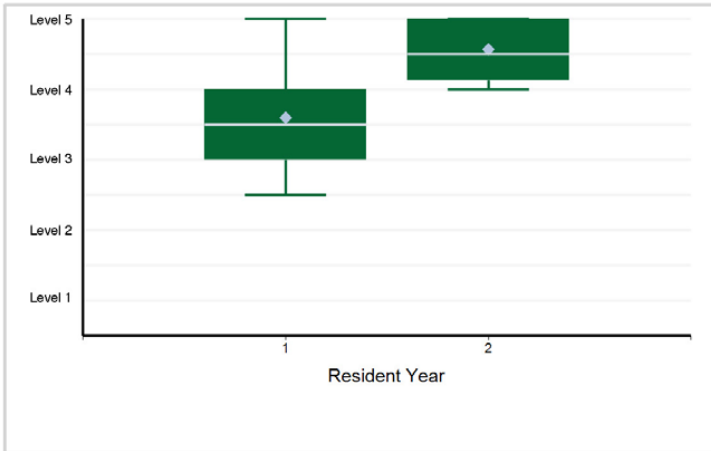

20. Interpersonal and Communication Skills - Interpersonal and Communication Skills 2: Communication with Patients and Families

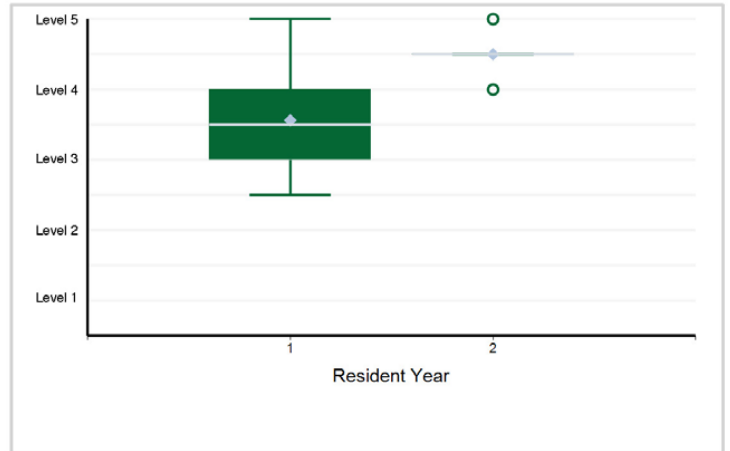

Specialty Box Plot Report - Milestone Evaluation by Resident Year: Year-End 2021-2022

TABLE 97: SUBSPECIALTY: **Developmental-Behavioral Pediatrics**

Resident Year	1	2	3	Total Residents
# of Residents	46	30	37	113

1. Patient Care - PC1. Provide transfer of care that ensures seamless transitions

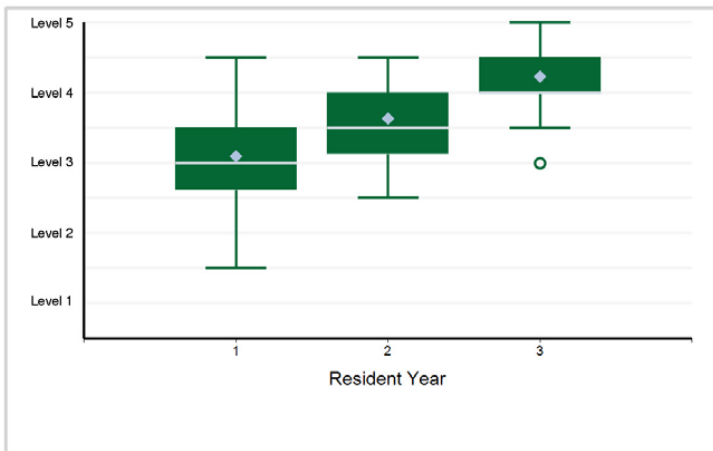

2. Patient Care - PC2. Make informed diagnostic and therapeutic decisions that result in optimal clinical judgment

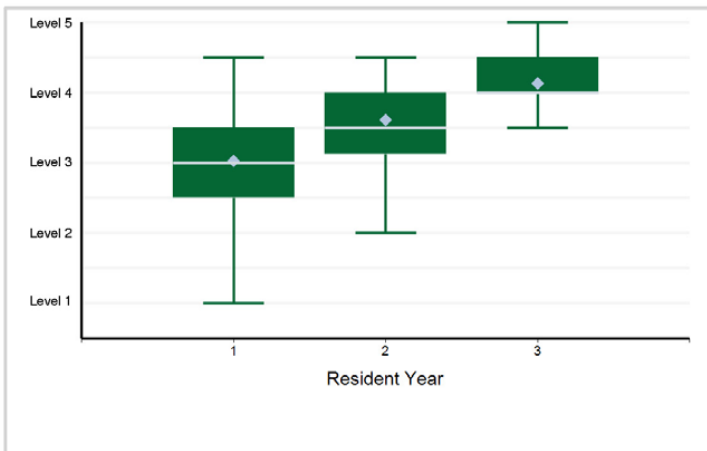

3. Patient Care - PC3. Develop and carry out management plans

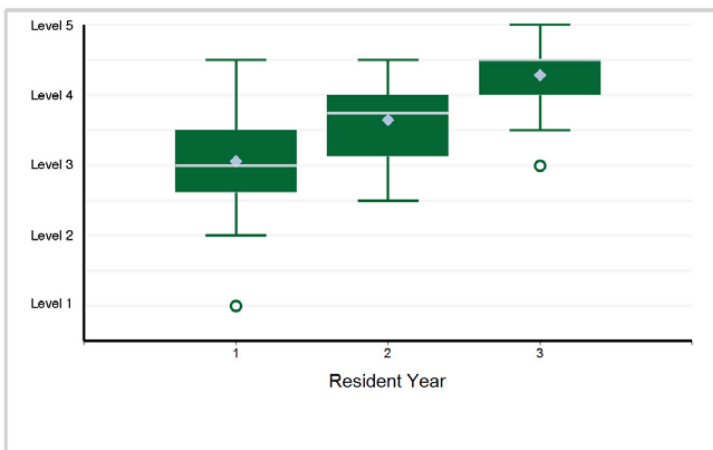

4. Patient Care - PC4. Provide appropriate role modeling

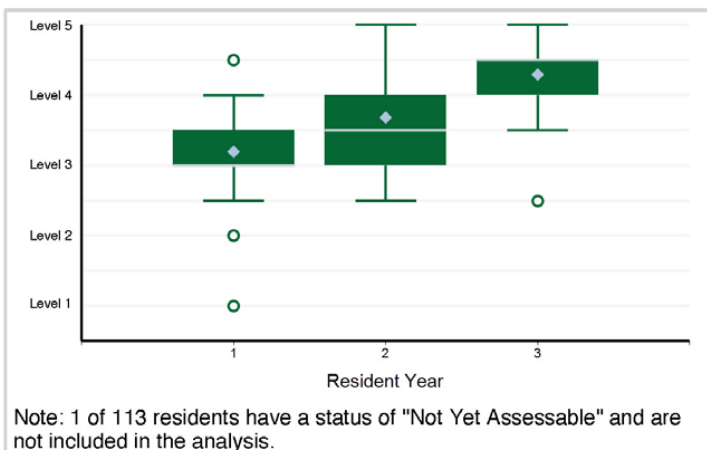

Note: 1 of 113 residents have a status of "Not Yet Assessable" and are not included in the analysis.

5. Medical Knowledge - MK1. Locate, appraise, and assimilate evidence from scientific studies related to ...

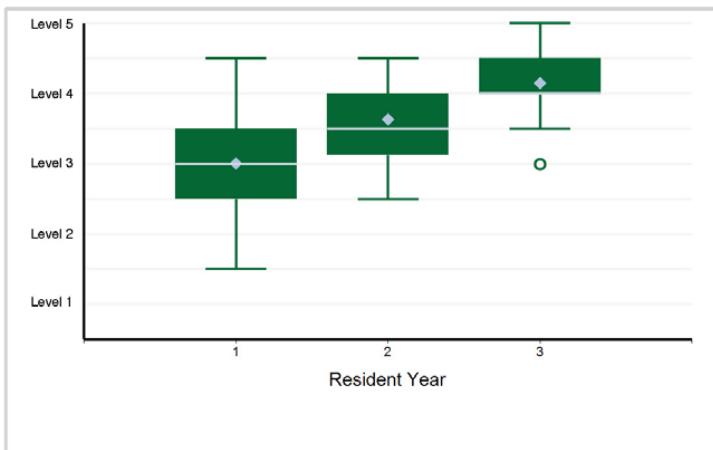

6. Systems-Based Practice - SBP1. Work effectively in various health care delivery settings and systems ...

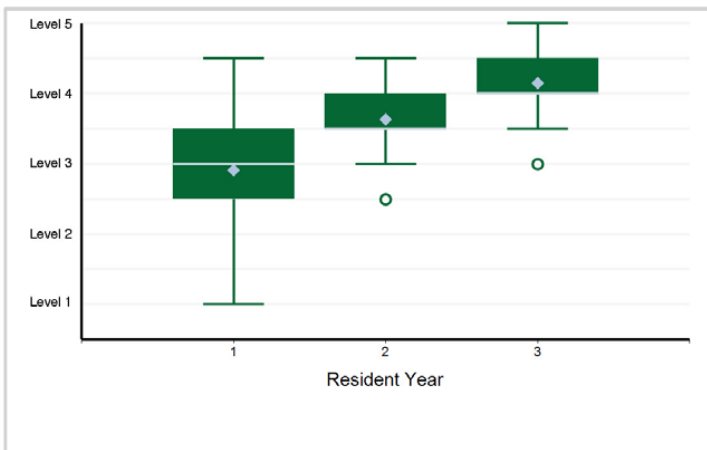

Specialty Box Plot Report - Milestone Evaluation by Resident Year: Year-End 2021-2022

SUBSPECIALTY: Developmental-Behavioral Pediatrics

7. Systems-Based Practice - SBP2. Coordinate patient care within the health care system relevant to their clinical specialty

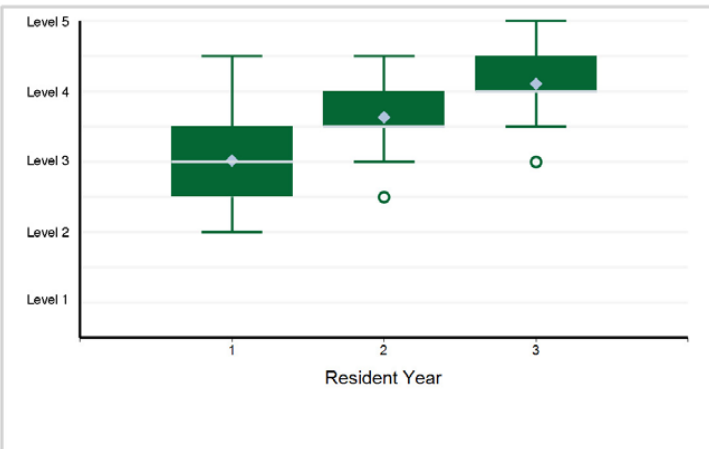

8. Systems-Based Practice - SBP3. Incorporate considerations of cost awareness and risk-benefit analysis in patient and/or ...

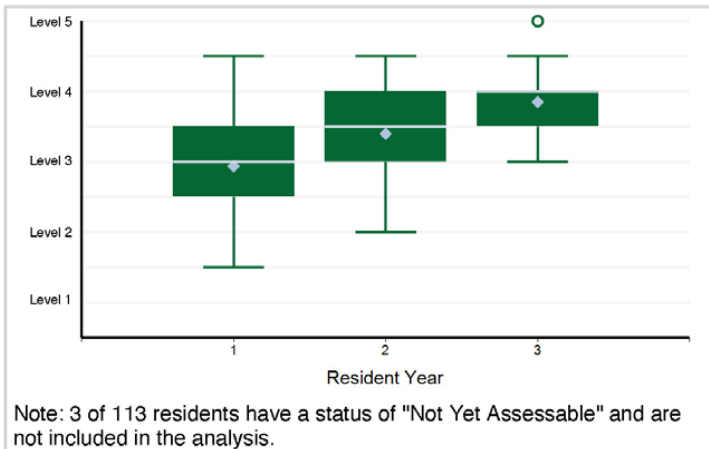

9. Systems-Based Practice - SBP4. Work in interprofessional teams to enhance patient safety and improve patient care quality

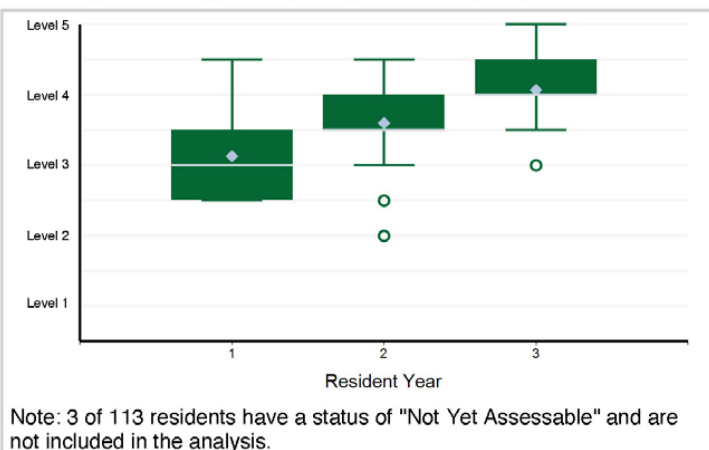

10. Systems-Based Practice - SBP5. Participate in identifying system errors and implementing potential systems solutions

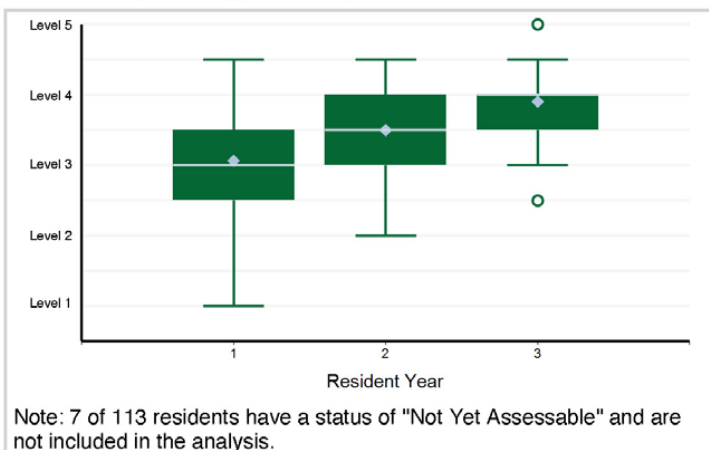

11. Practice-Based Learning and Improvement - PBLI1. Identify strengths, deficiencies, and limits in one's knowledge and expertise

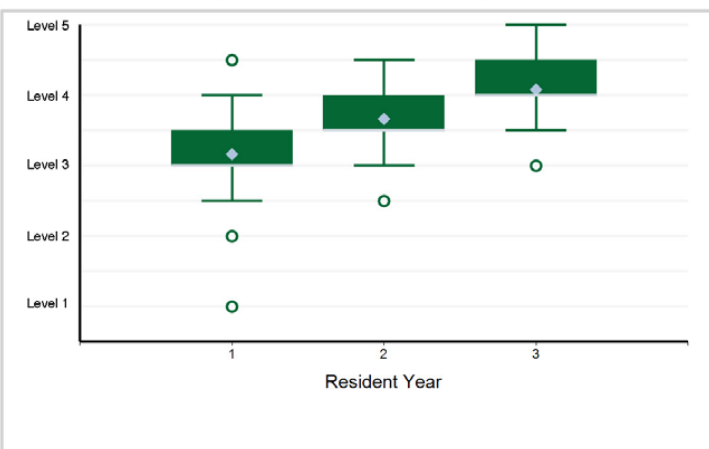

12. Practice-Based Learning and Improvement - PBLI2. Systematically analyze practice using quality improvement methods, and ...

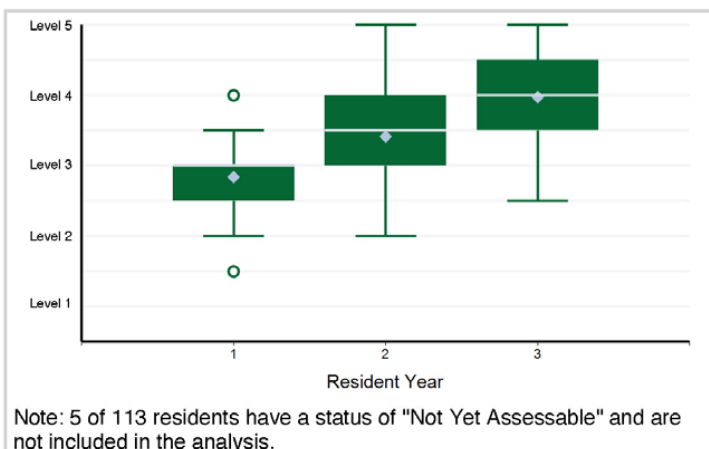

Specialty Box Plot Report - Milestone Evaluation by Resident Year: Year-End 2021-2022

SUBSPECIALTY: Developmental-Behavioral Pediatrics

13. Practice-Based Learning and Improvement - PBLI3. Use information technology to optimize learning and care delivery

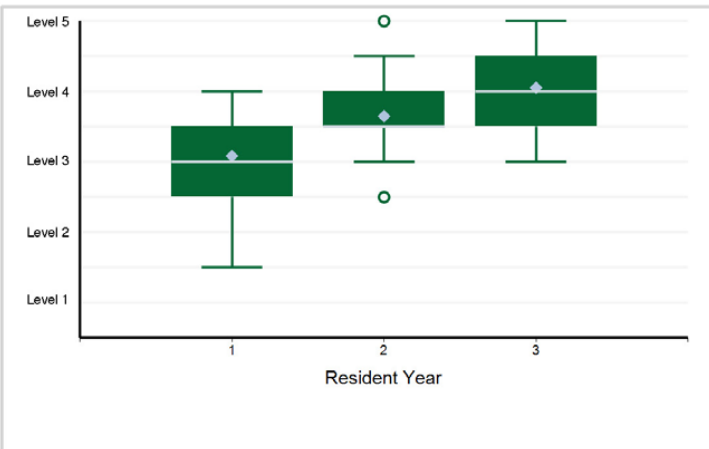

14. Practice-Based Learning and Improvement - PBLI4. Participate in the education of patients, families, ...

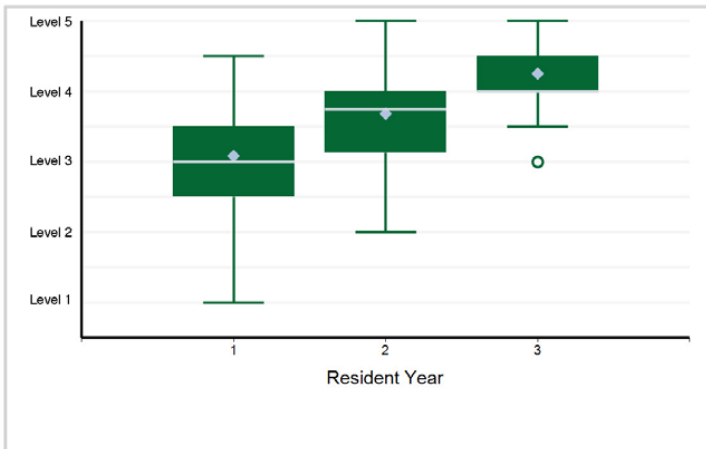

15. Professionalism - PROF1. Professional Conduct: High standards of ethical behavior which includes maintaining ...

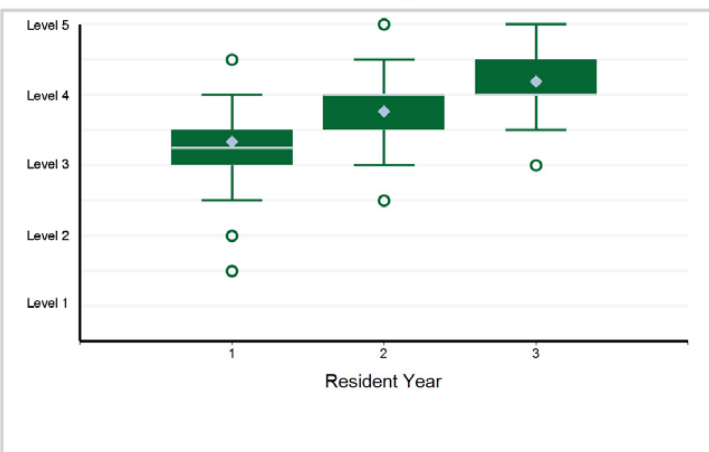

16. Professionalism - PROF2. Trustworthiness that makes colleagues feel secure when one is responsible for the care of patients

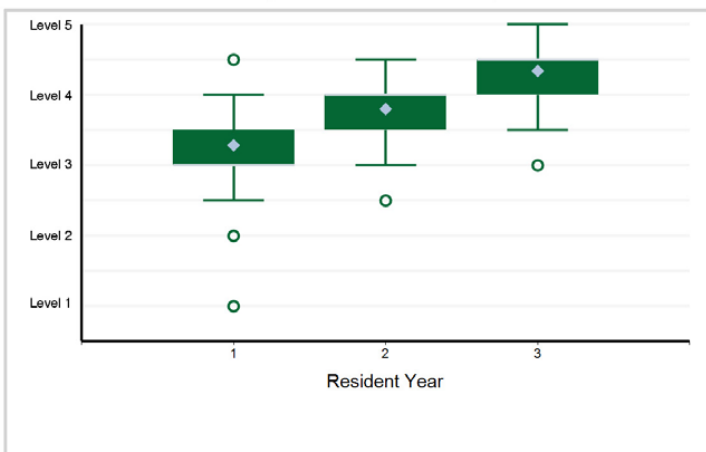

17. Professionalism - PROF3. Provide leadership skills that enhance team functioning, the learning environment, ...

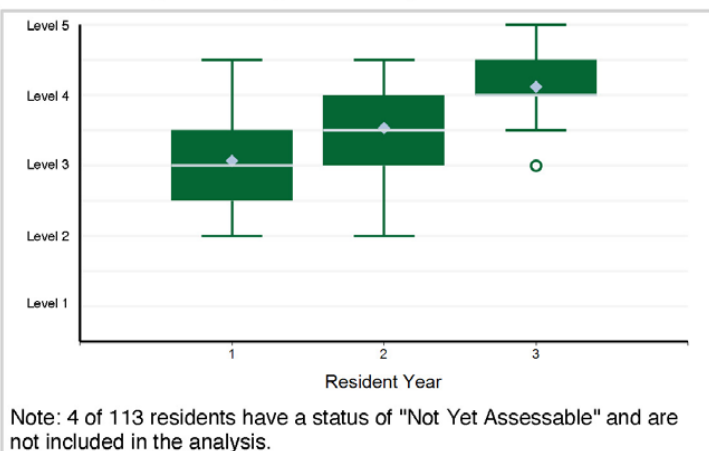

18. Professionalism - PROF4. The capacity to accept that ambiguity is part of clinical medicine and to recognize ...

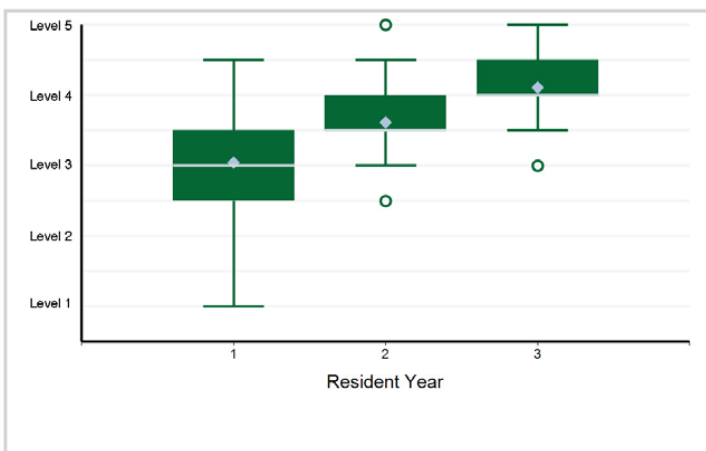

Note: 4 of 113 residents have a status of "Not Yet Assessable" and are not included in the analysis.

Specialty Box Plot Report - Milestone Evaluation by Resident Year: Year-End 2021-2022

SUBSPECIALTY: **Developmental-Behavioral Pediatrics**

19. Interpersonal and Communication Skills - ICS1. Communicate effectively with physicians, other health professionals, and ...

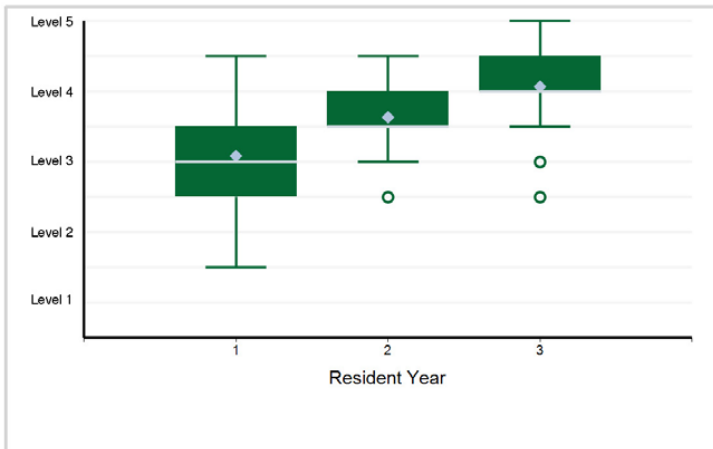

20. Interpersonal and Communication Skills - ICS2. Work effectively as a member or leader of a health care ...

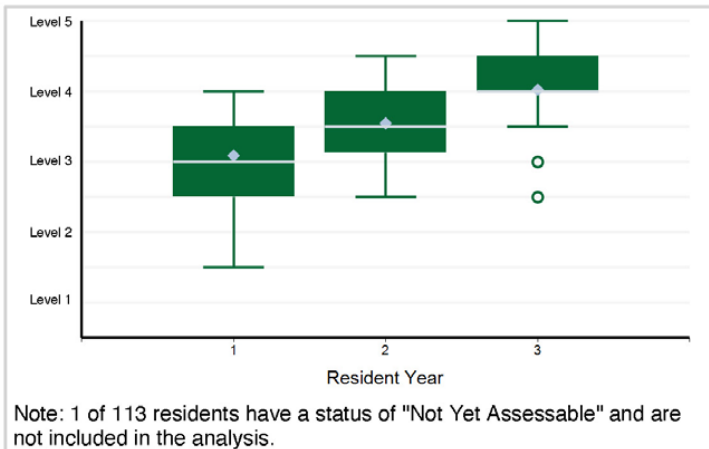

21. Interpersonal and Communication Skills - ICS3. Act in a consultative role to other physicians and health professionals

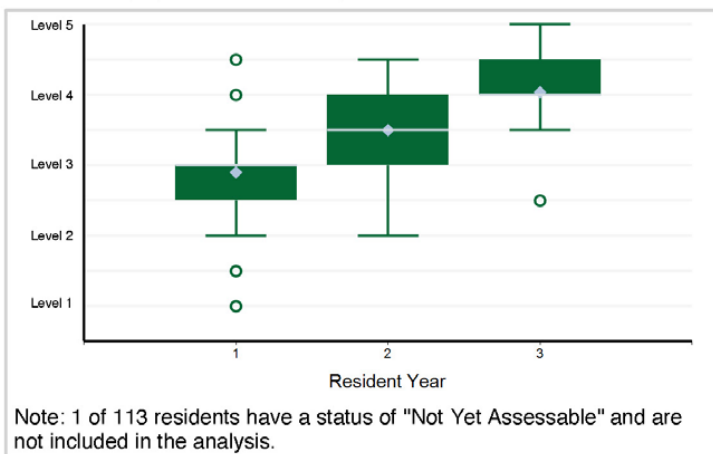

Specialty Box Plot Report - Milestone Evaluation by Resident Year: Year-End 2021-2022

TABLE 98: SUBSPECIALTY: Neonatal-Perinatal Medicine

Resident Year	1	2	3	Total Residents
# of Residents	299	252	252	803

1. Patient Care - PC1. Provide transfer of care that ensures seamless transitions

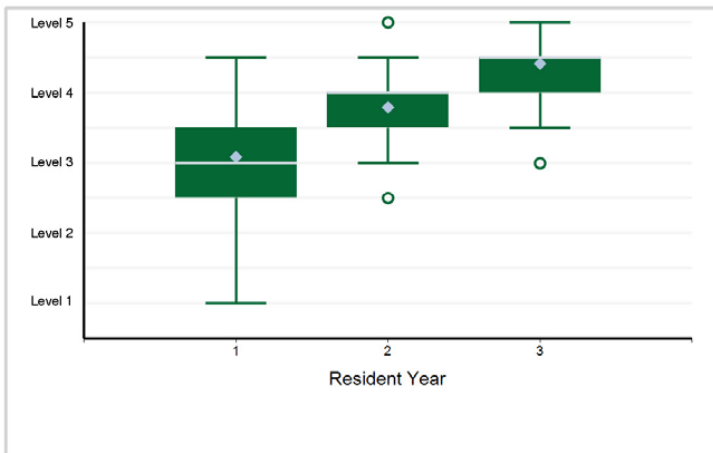

2. Patient Care - PC2. Make informed diagnostic and therapeutic decisions that result in optimal clinical judgment

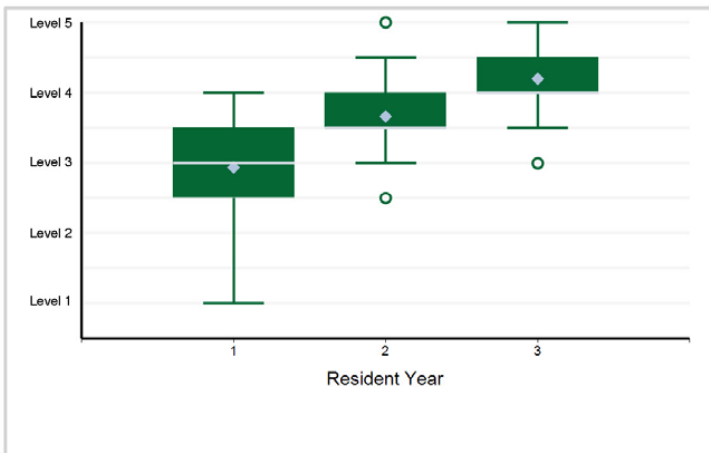

3. Patient Care - PC3. Develop and carry out management plans

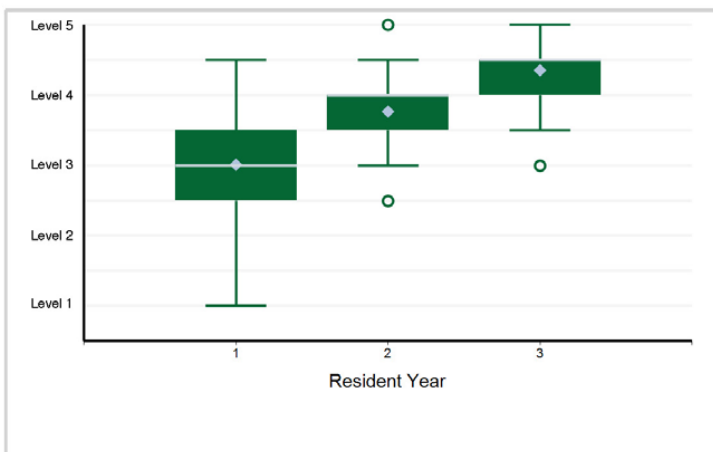

4. Patient Care - PC4. Provide appropriate role modeling

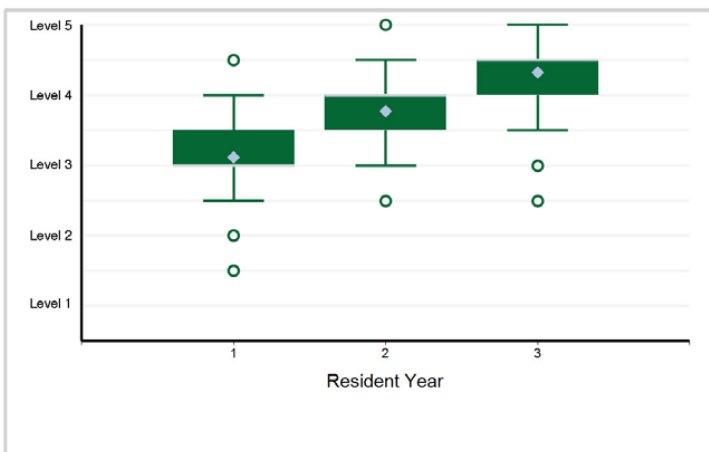

5. Medical Knowledge - MK1. Locate, appraise, and assimilate evidence from scientific studies related to ...

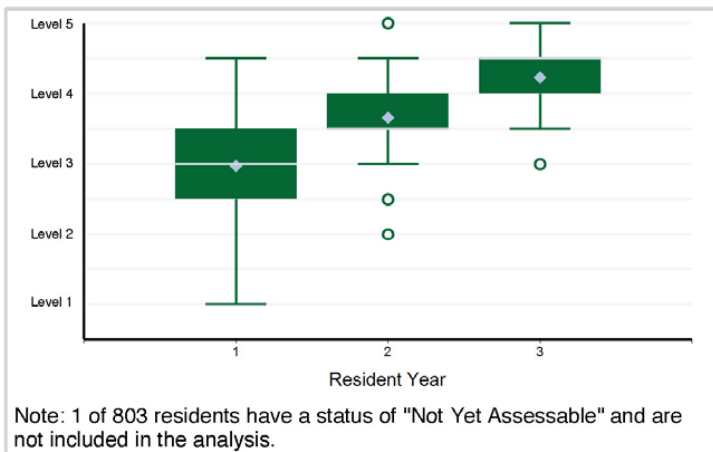

6. Systems-Based Practice - SBP1. Work effectively in various health care delivery settings and systems ...

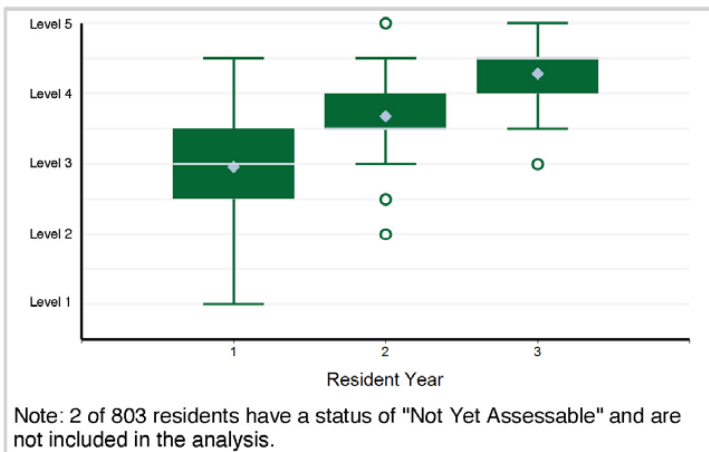

Note: 1 of 803 residents have a status of "Not Yet Assessable" and are not included in the analysis.

Note: 2 of 803 residents have a status of "Not Yet Assessable" and are not included in the analysis.

Specialty Box Plot Report - Milestone Evaluation by Resident Year: Year-End 2021-2022

SUBSPECIALTY: Neonatal-Perinatal Medicine

7. Systems-Based Practice - SBP2. Coordinate patient care within the health care system relevant to their clinical specialty

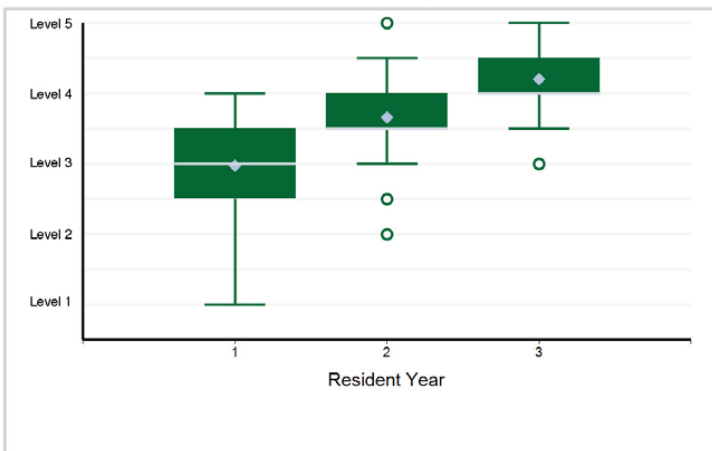

8. Systems-Based Practice - SBP3. Incorporate considerations of cost awareness and risk-benefit analysis in patient and/or ...

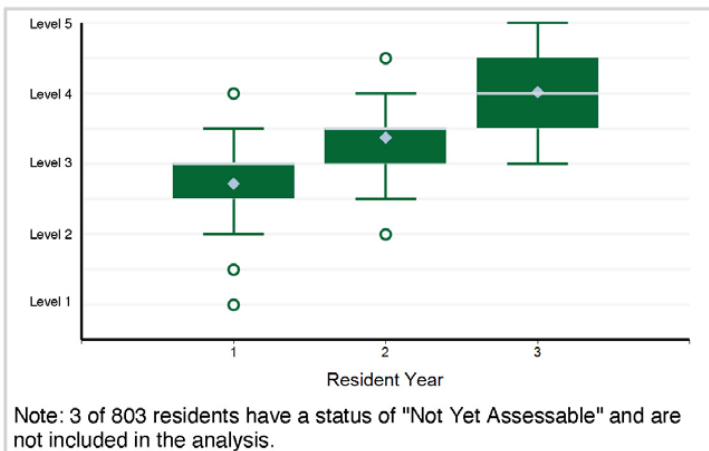

9. Systems-Based Practice - SBP4. Work in interprofessional teams to enhance patient safety and improve patient care quality

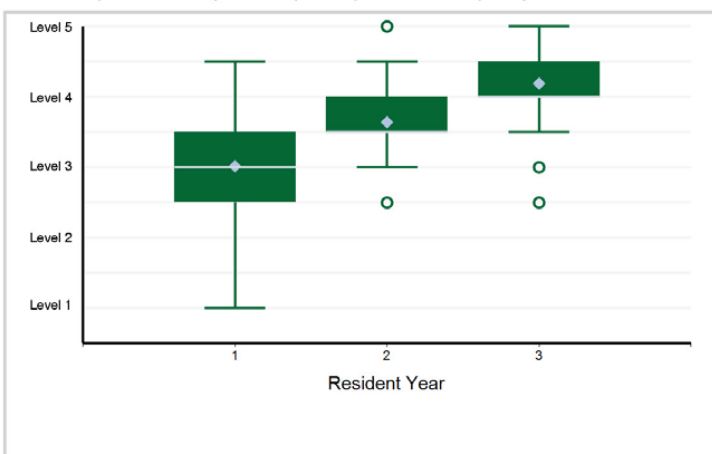

10. Systems-Based Practice - SBP5. Participate in identifying system errors and implementing potential systems solutions

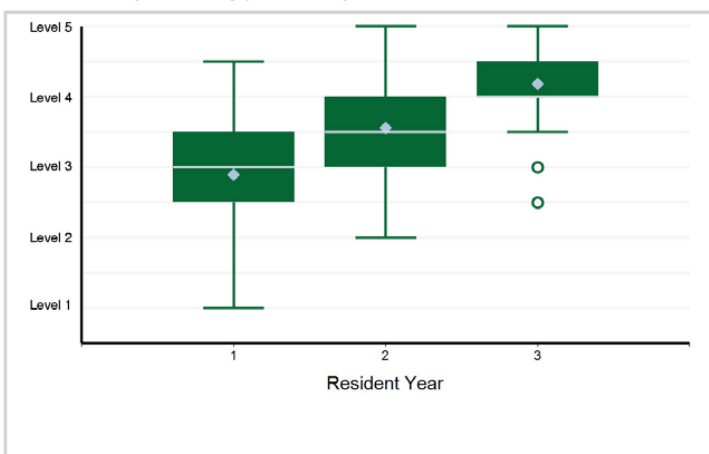

11. Practice-Based Learning and Improvement - PBLI1. Identify strengths, deficiencies, and limits in one's knowledge and expertise

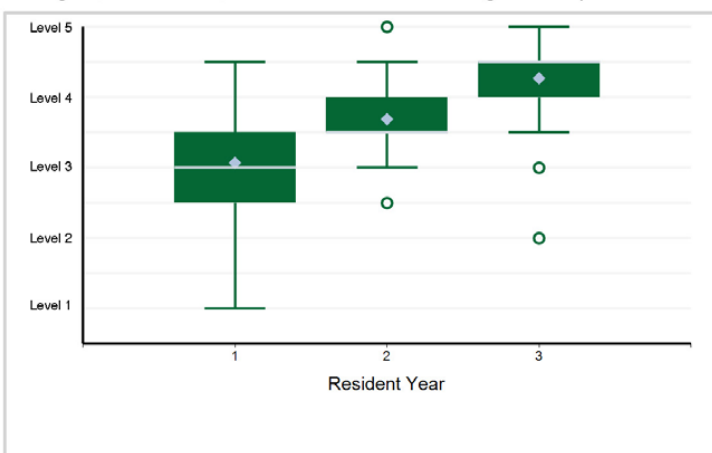

12. Practice-Based Learning and Improvement - PBLI2. Systematically analyze practice using quality improvement methods, and ...

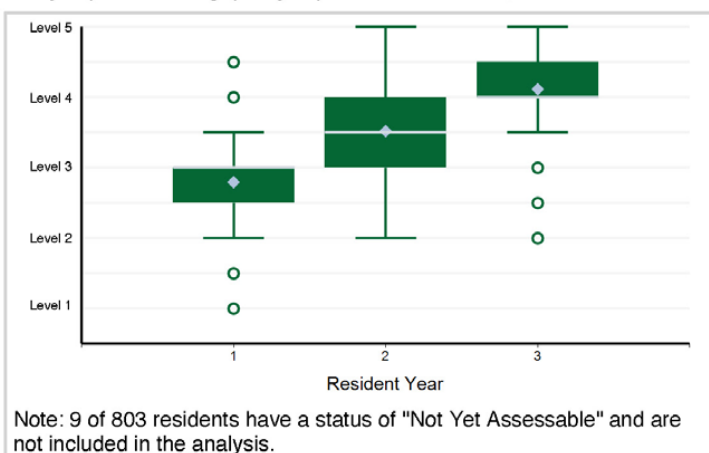

Specialty Box Plot Report - Milestone Evaluation by Resident Year: Year-End 2021-2022

SUBSPECIALTY: Neonatal-Perinatal Medicine

13. Practice-Based Learning and Improvement - PBLI3. Use information technology to optimize learning and care delivery

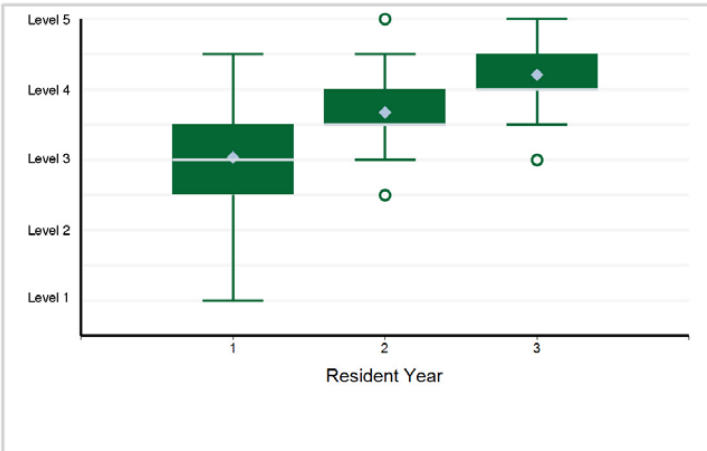

14. Practice-Based Learning and Improvement - PBLI4. Participate in the education of patients, families, ...

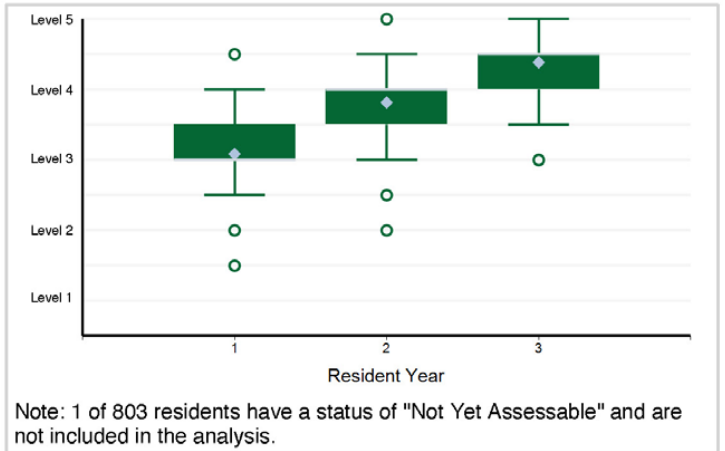

15. Professionalism - PROF1. Professional Conduct: High standards of ethical behavior which includes maintaining ...

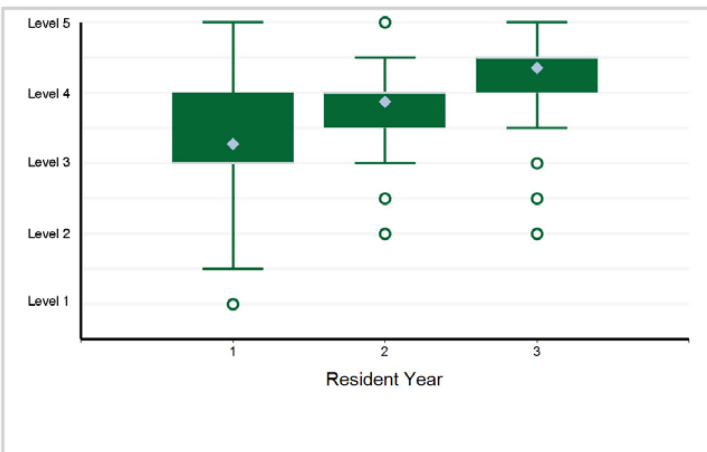

16. Professionalism - PROF2. Trustworthiness that makes colleagues feel secure when one is responsible for the care of patients

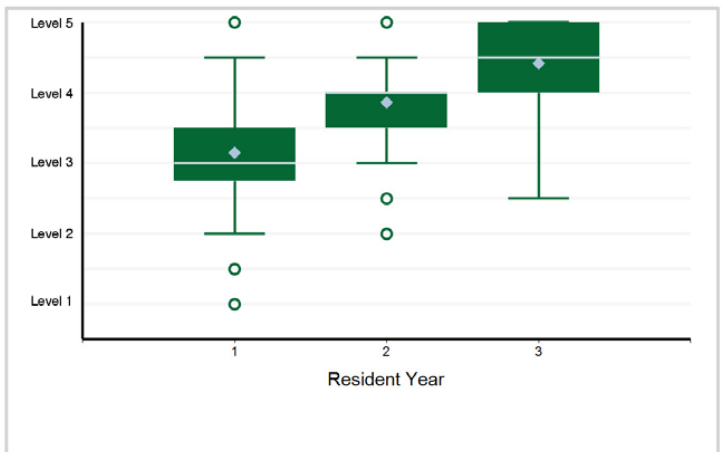

17. Professionalism - PROF3. Provide leadership skills that enhance team functioning, the learning environment, ...

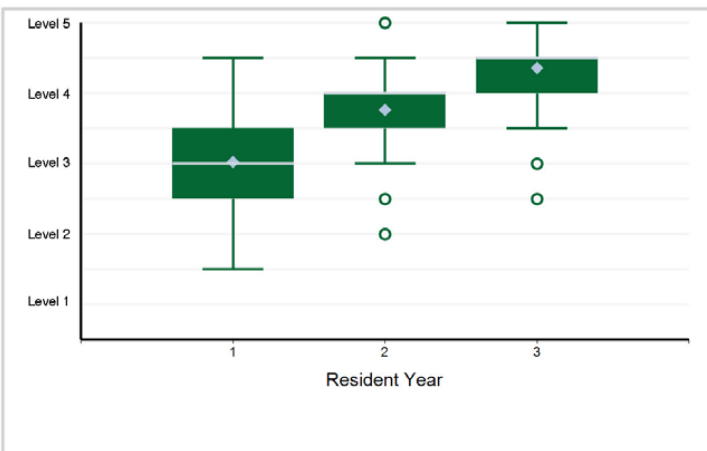

18. Professionalism - PROF4. The capacity to accept that ambiguity is part of clinical medicine and to recognize ...

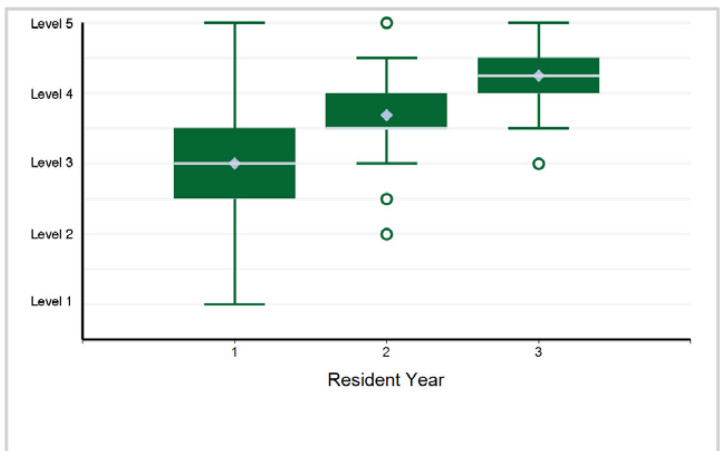

Specialty Box Plot Report - Milestone Evaluation by Resident Year: Year-End 2021-2022

SUBSPECIALTY: Neonatal-Perinatal Medicine

19. Interpersonal and Communication Skills - ICS1. Communicate effectively with physicians, other health professionals, and ...

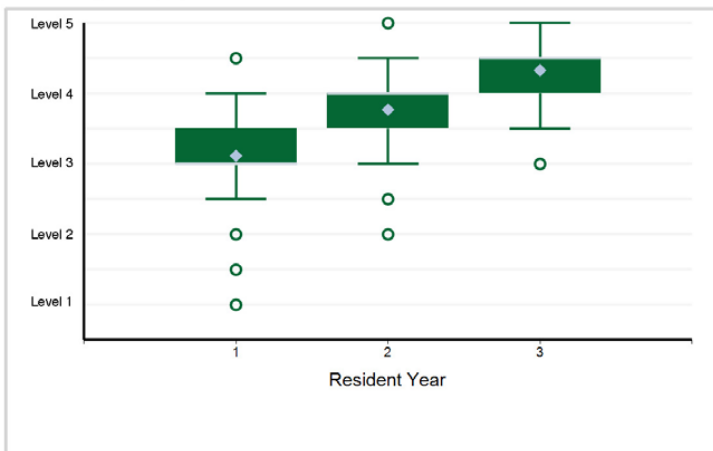

20. Interpersonal and Communication Skills - ICS2. Work effectively as a member or leader of a health care ...

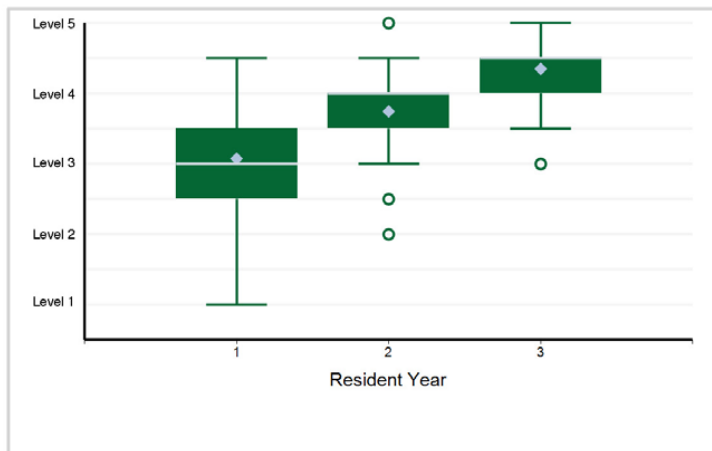

21. Interpersonal and Communication Skills - ICS3. Act in a consultative role to other physicians and health professionals

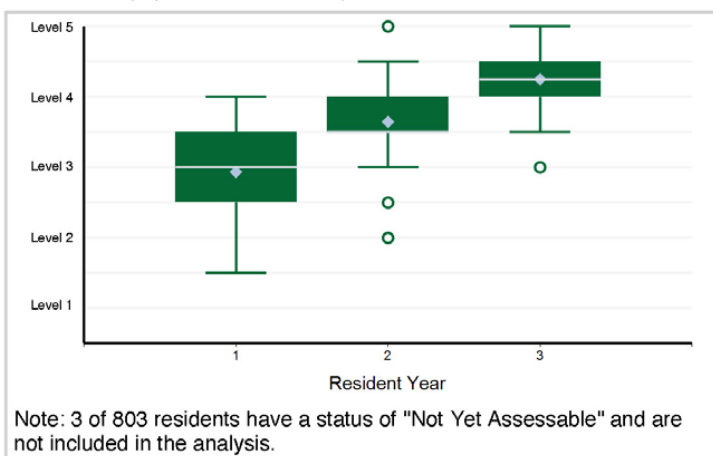

Specialty Box Plot Report - Milestone Evaluation by Resident Year: Year-End 2021-2022

TABLE 99: SUBSPECIALTY: **Pediatric Cardiology**

Resident Year	1	2	3	Total Residents
# of Residents	165	161	157	483

1. Patient Care - PC1. Provide transfer of care that ensures seamless transitions

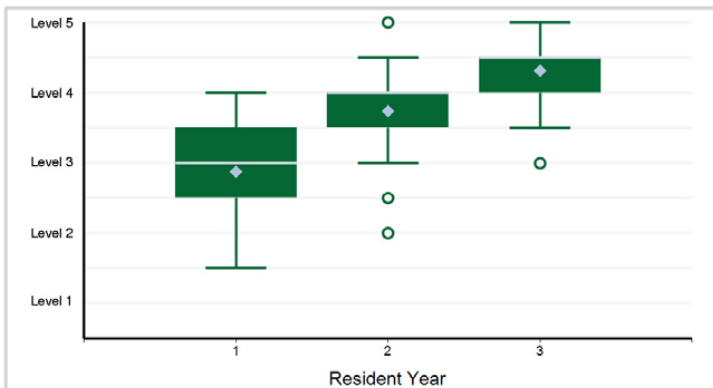

Note: 2 of 483 residents have a status of "Not Yet Assessable" and are not included in the analysis.

2. Patient Care - PC2. Make informed diagnostic and therapeutic decisions that result in optimal clinical judgment

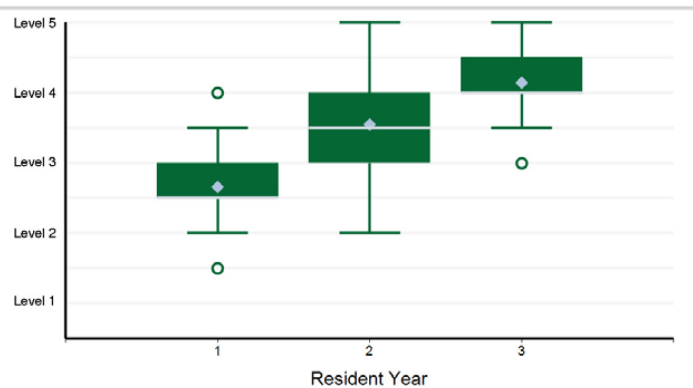

Note: 1 of 483 residents have a status of "Not Yet Assessable" and are not included in the analysis.

3. Patient Care - PC3. Develop and carry out management plans

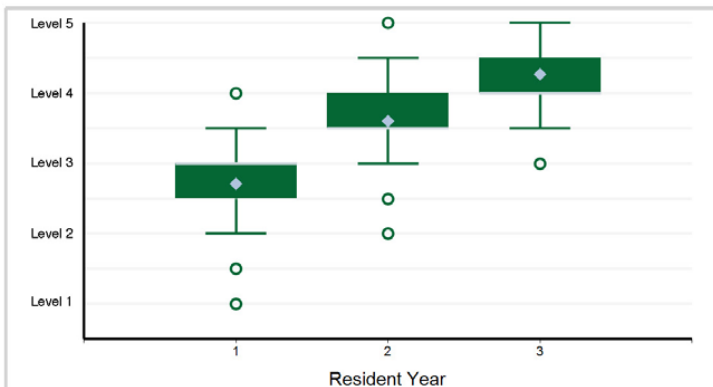

Note: 1 of 483 residents have a status of "Not Yet Assessable" and are not included in the analysis.

4. Patient Care - PC4. Provide appropriate role modeling

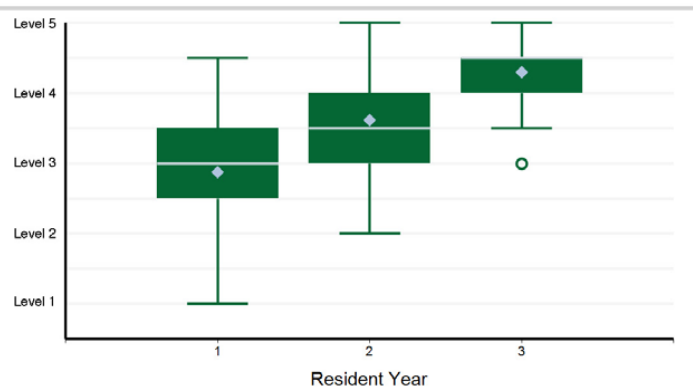

Note: 3 of 483 residents have a status of "Not Yet Assessable" and are not included in the analysis.

5. Medical Knowledge - MK1. Locate, appraise, and assimilate evidence from scientific studies related to ...

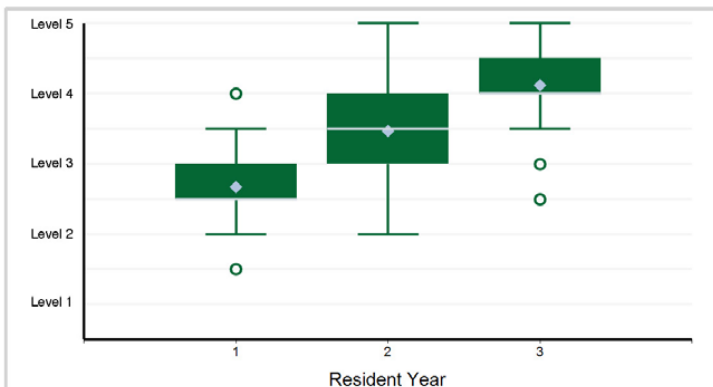

6. Systems-Based Practice - SBP1. Work effectively in various health care delivery settings and systems ...

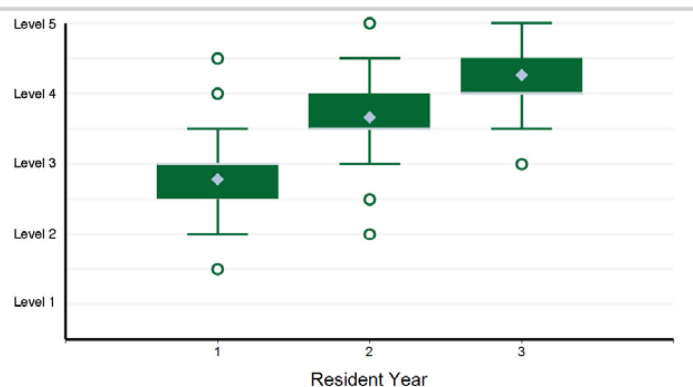

Note: 3 of 483 residents have a status of "Not Yet Assessable" and are not included in the analysis.

Specialty Box Plot Report - Milestone Evaluation by Resident Year: Year-End 2021-2022

SUBSPECIALTY: Pediatric Cardiology

7. Systems-Based Practice - SBP2. Coordinate patient care within the health care system relevant to their clinical specialty

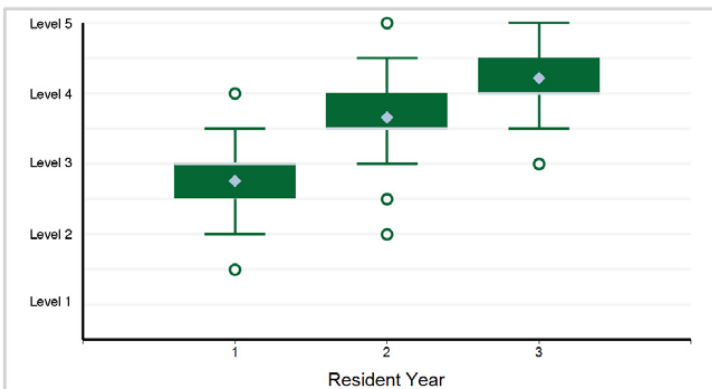

Note: 1 of 483 residents have a status of "Not Yet Assessable" and are not included in the analysis.

8. Systems-Based Practice - SBP3. Incorporate considerations of cost awareness and risk-benefit analysis in patient and/or ...

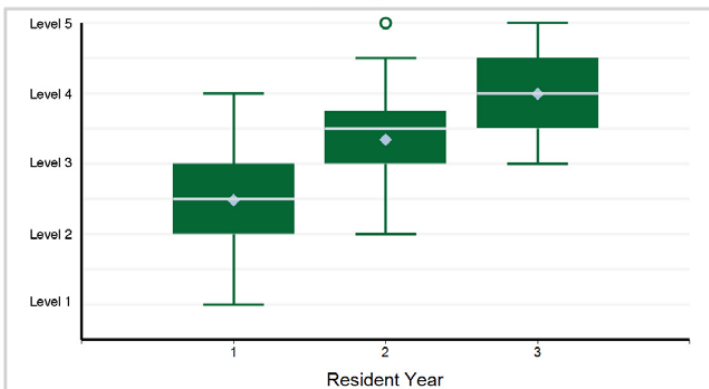

Note: 9 of 483 residents have a status of "Not Yet Assessable" and are not included in the analysis.

9. Systems-Based Practice - SBP4. Work in interprofessional teams to enhance patient safety and improve patient care quality

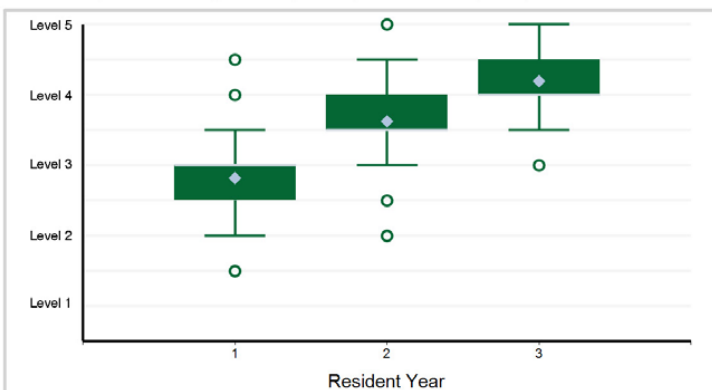

10. Systems-Based Practice - SBP5. Participate in identifying system errors and implementing potential systems solutions

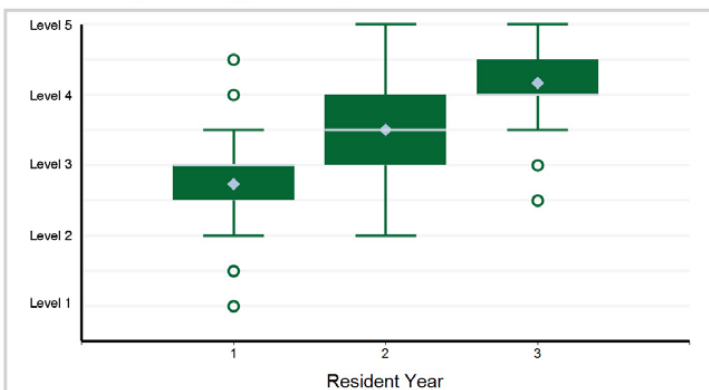

Note: 2 of 483 residents have a status of "Not Yet Assessable" and are not included in the analysis.

11. Practice-Based Learning and Improvement - PBLI1. Identify strengths, deficiencies, and limits in one's knowledge and expertise

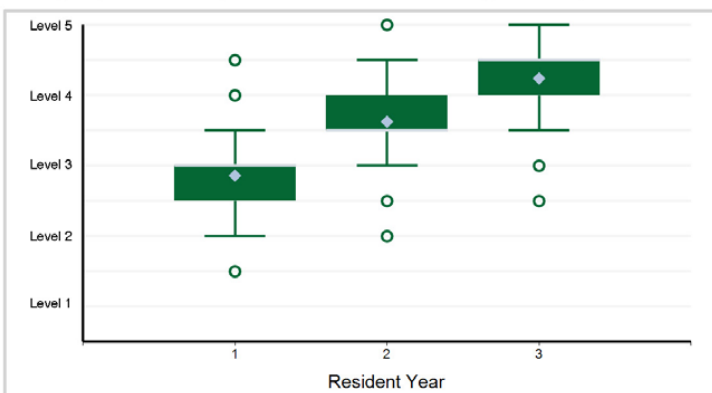

12. Practice-Based Learning and Improvement - PBLI2. Systematically analyze practice using quality improvement methods, and ...

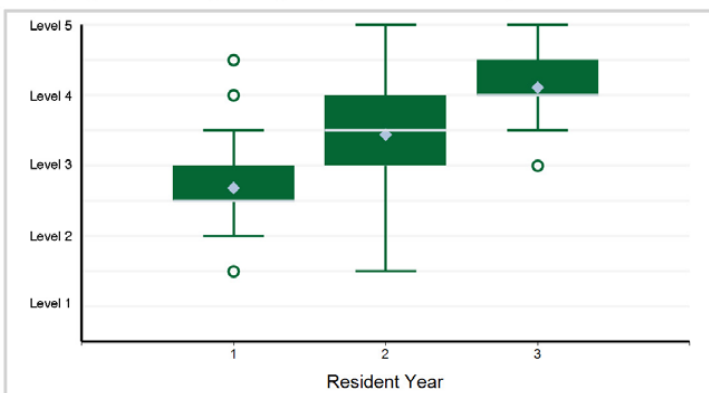

Note: 17 of 483 residents have a status of "Not Yet Assessable" and are not included in the analysis.

Specialty Box Plot Report - Milestone Evaluation by Resident Year: Year-End 2021-2022

SUBSPECIALTY: Pediatric Cardiology

13. Practice-Based Learning and Improvement - PBLI3. Use information technology to optimize learning and care delivery

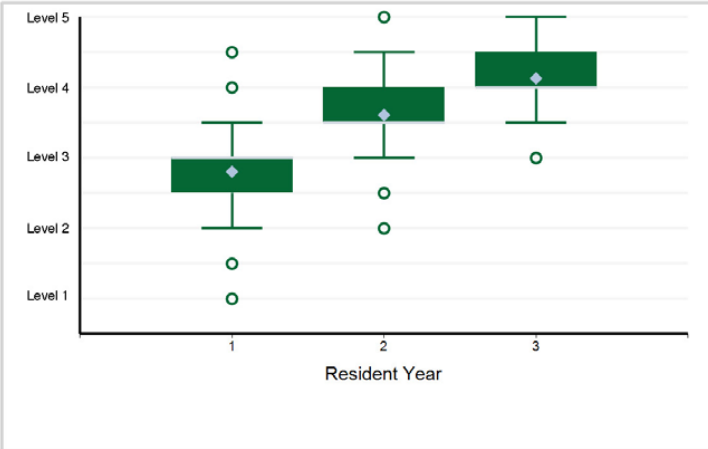

14. Practice-Based Learning and Improvement - PBLI4. Participate in the education of patients, families, ...

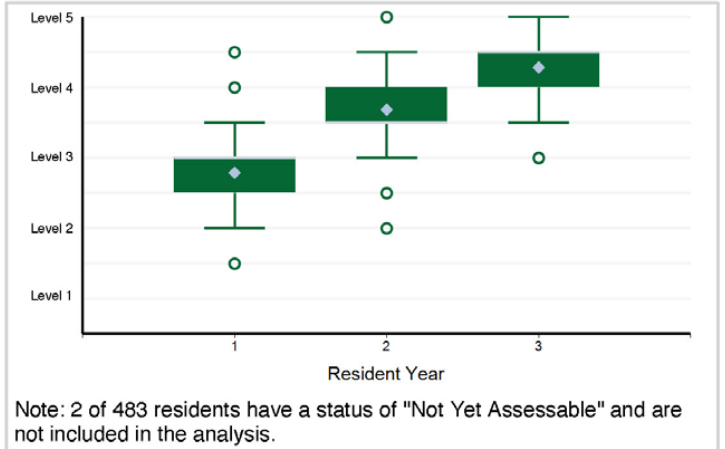

15. Professionalism - PROF1. Professional Conduct: High standards of ethical behavior which includes maintaining ...

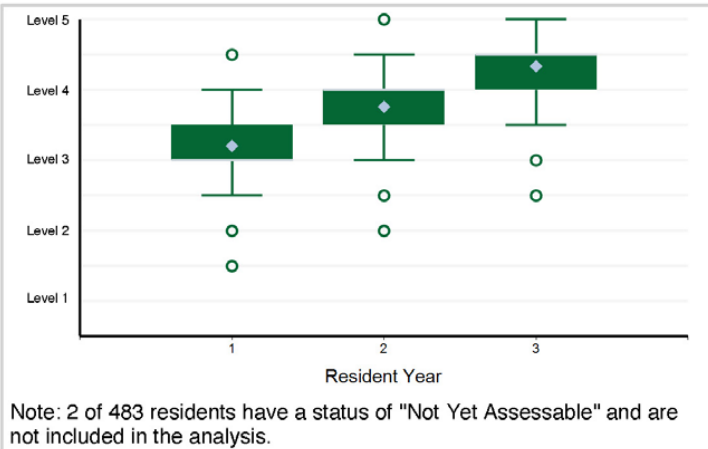

16. Professionalism - PROF2. Trustworthiness that makes colleagues feel secure when one is responsible for the care of patients

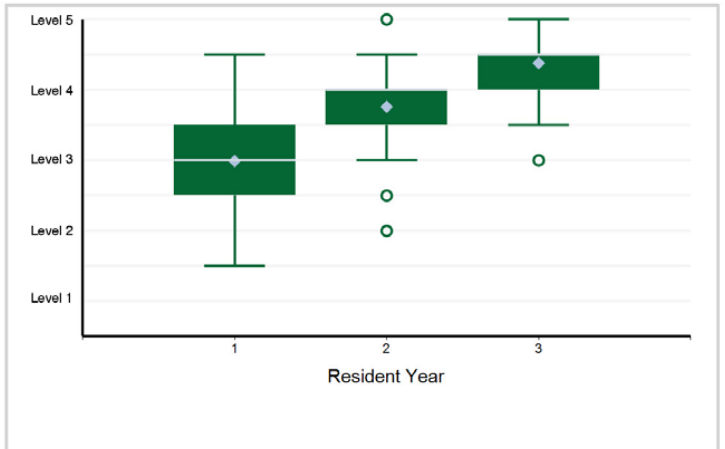

17. Professionalism - PROF3. Provide leadership skills that enhance team functioning, the learning environment, ...

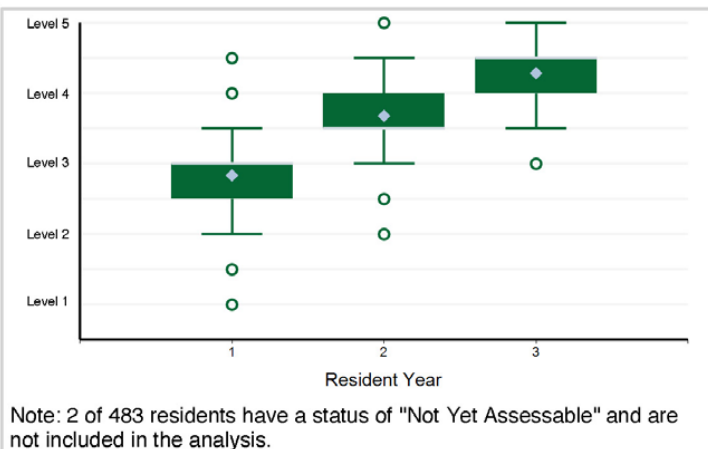

18. Professionalism - PROF4. The capacity to accept that ambiguity is part of clinical medicine and to recognize ...

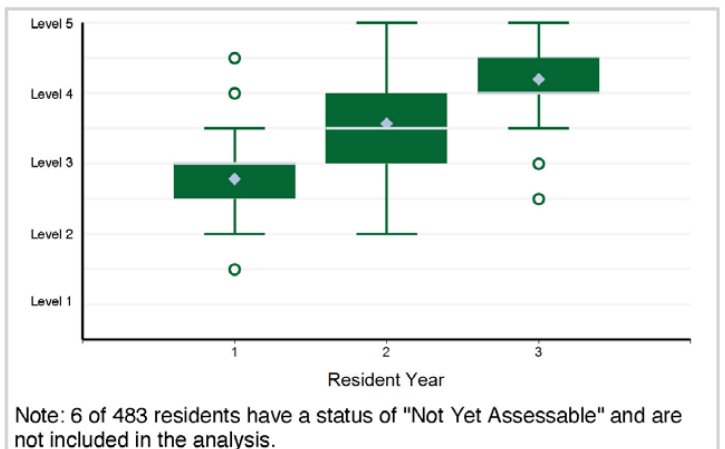

Specialty Box Plot Report - Milestone Evaluation by Resident Year: Year-End 2021-2022

SUBSPECIALTY: Pediatric Cardiology

19. Interpersonal and Communication Skills - ICS1. Communicate effectively with physicians, other health professionals, and ...

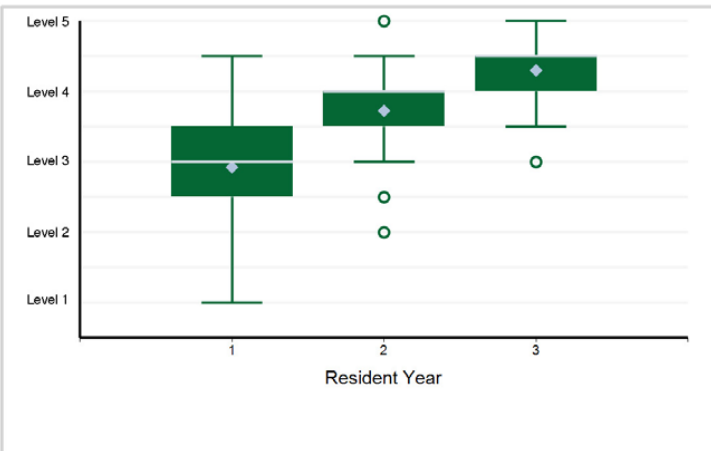

20. Interpersonal and Communication Skills - ICS2. Work effectively as a member or leader of a health care ...

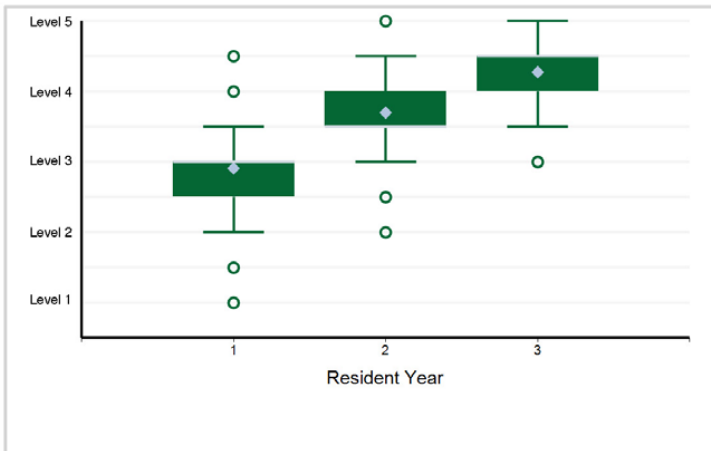

21. Interpersonal and Communication Skills - ICS3. Act in a consultative role to other physicians and health professionals

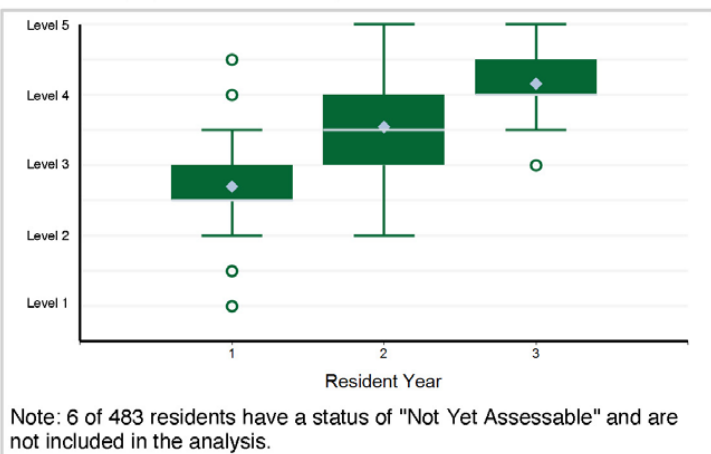

Note: 6 of 483 residents have a status of "Not Yet Assessable" and are not included in the analysis.

Specialty Box Plot Report - Milestone Evaluation by Resident Year: Year-End 2021-2022

TABLE 100: SUBSPECIALTY: **Pediatric Critical Care Medicine**

Resident Year	1	2	3	Total Residents
# of Residents	210	202	184	596

1. Patient Care - PC1. Provide transfer of care that ensures seamless transitions

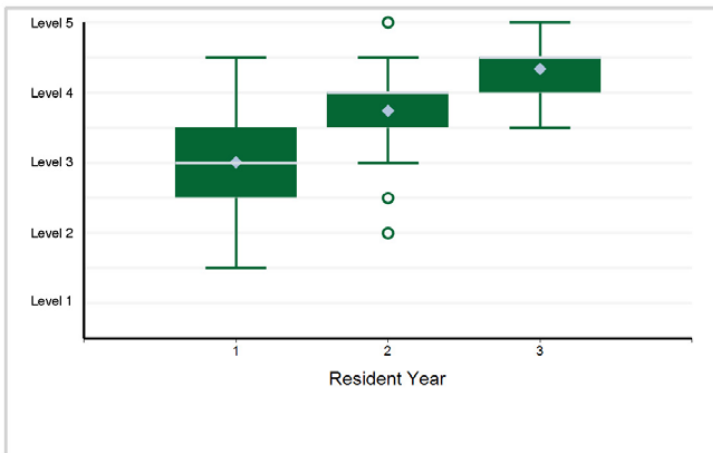

2. Patient Care - PC2. Make informed diagnostic and therapeutic decisions that result in optimal clinical judgment

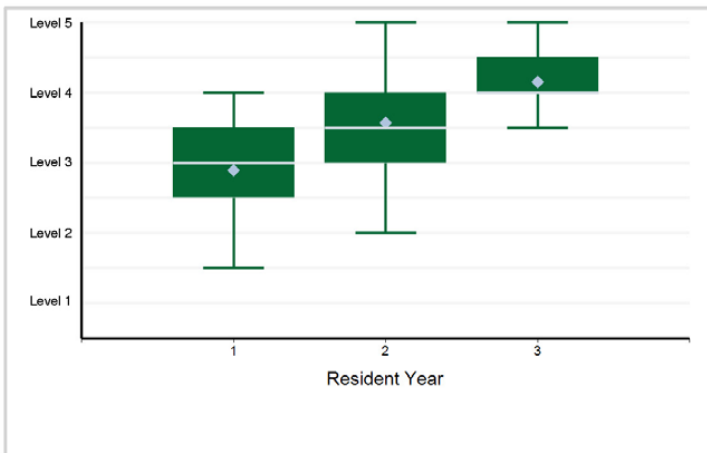

3. Patient Care - PC3. Develop and carry out management plans

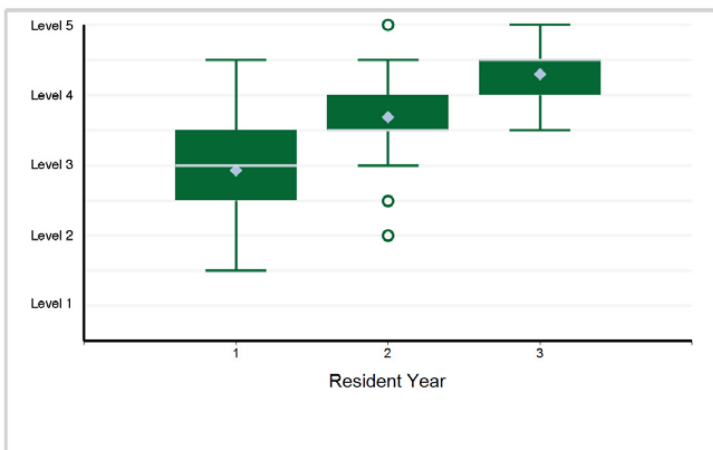

4. Patient Care - PC4. Provide appropriate role modeling

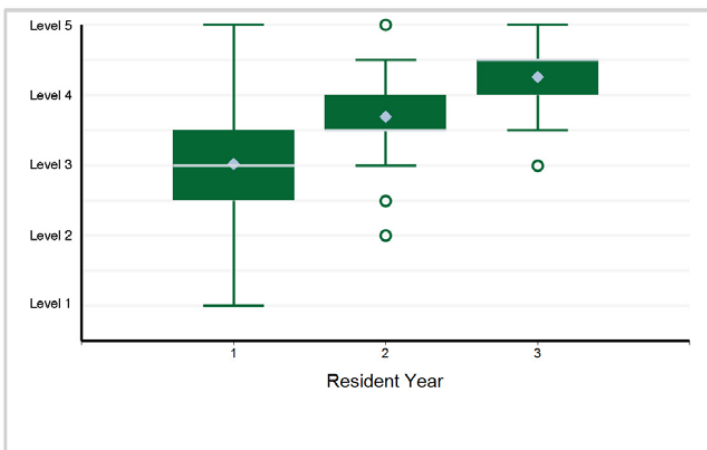

5. Medical Knowledge - MK1. Locate, appraise, and assimilate evidence from scientific studies related to ...

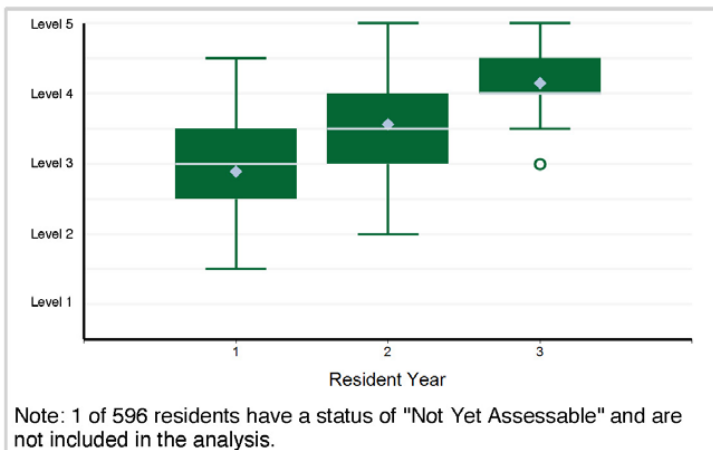

6. Systems-Based Practice - SBP1. Work effectively in various health care delivery settings and systems ...

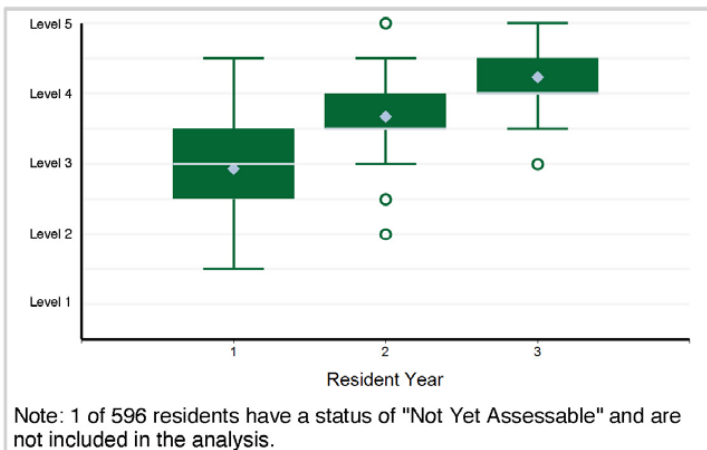

Note: 1 of 596 residents have a status of "Not Yet Assessable" and are not included in the analysis.

Note: 1 of 596 residents have a status of "Not Yet Assessable" and are not included in the analysis.

Specialty Box Plot Report - Milestone Evaluation by Resident Year: Year-End 2021-2022

SUBSPECIALTY: Pediatric Critical Care Medicine

7. Systems-Based Practice - SBP2. Coordinate patient care within the health care system relevant to their clinical specialty

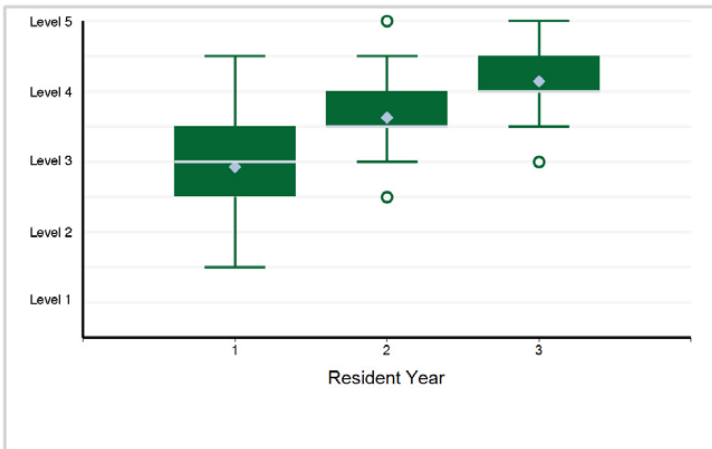

8. Systems-Based Practice - SBP3. Incorporate considerations of cost awareness and risk-benefit analysis in patient and/or ...

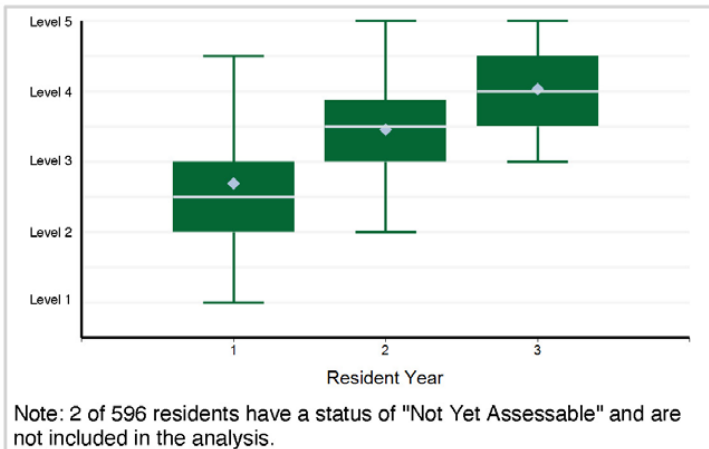

9. Systems-Based Practice - SBP4. Work in interprofessional teams to enhance patient safety and improve patient care quality

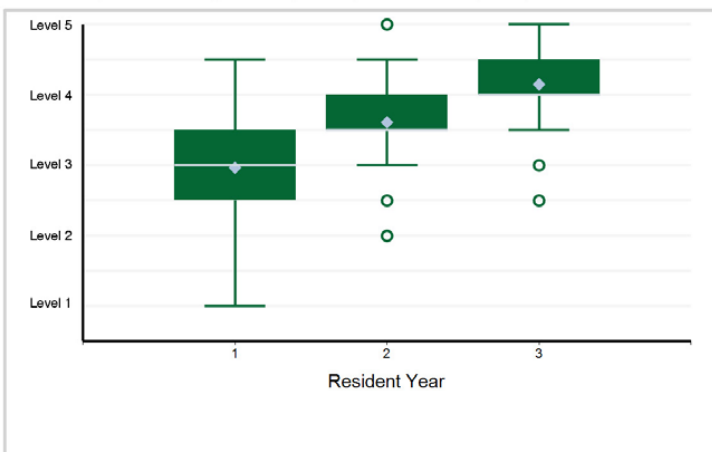

10. Systems-Based Practice - SBP5. Participate in identifying system errors and implementing potential systems solutions

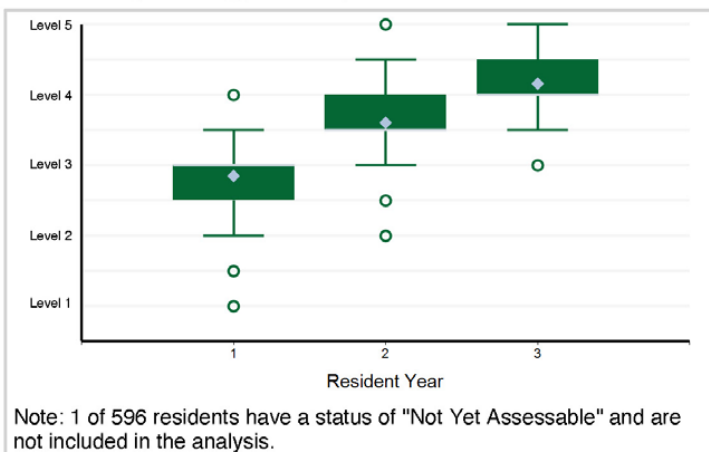

11. Practice-Based Learning and Improvement - PBLI1. Identify strengths, deficiencies, and limits in one's knowledge and expertise

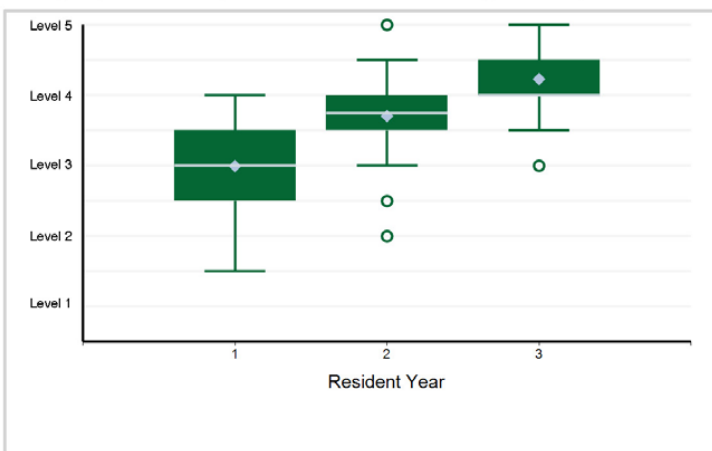

12. Practice-Based Learning and Improvement - PBLI2. Systematically analyze practice using quality improvement methods, and ...

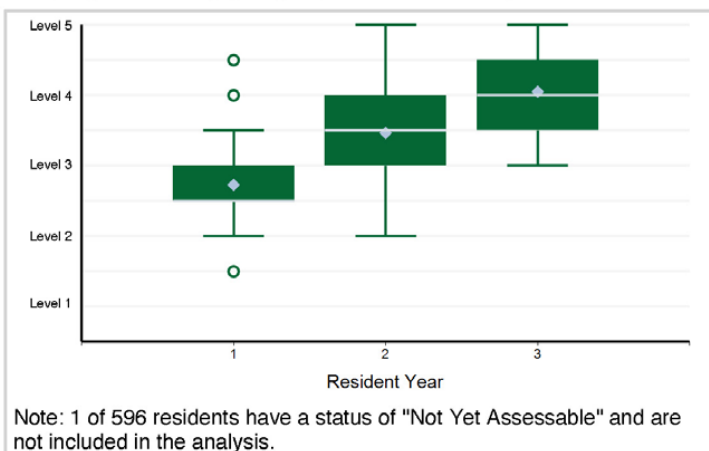

Specialty Box Plot Report - Milestone Evaluation by Resident Year: Year-End 2021-2022

SUBSPECIALTY: Pediatric Critical Care Medicine

13. Practice-Based Learning and Improvement - PBLI3. Use information technology to optimize learning and care delivery

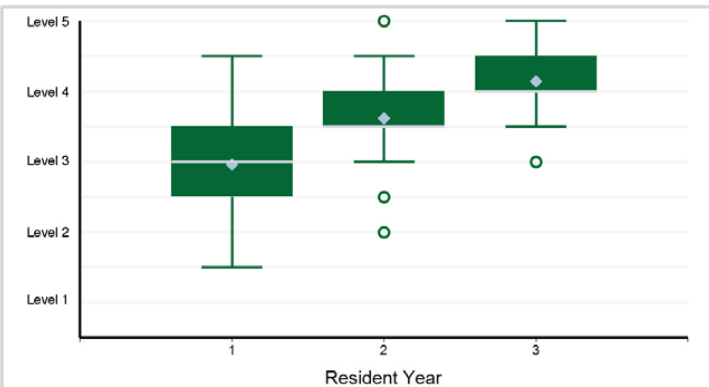

Note: 1 of 596 residents have a status of "Not Yet Assessable" and are not included in the analysis.

14. Practice-Based Learning and Improvement - PBLI4. Participate in the education of patients, families, ...

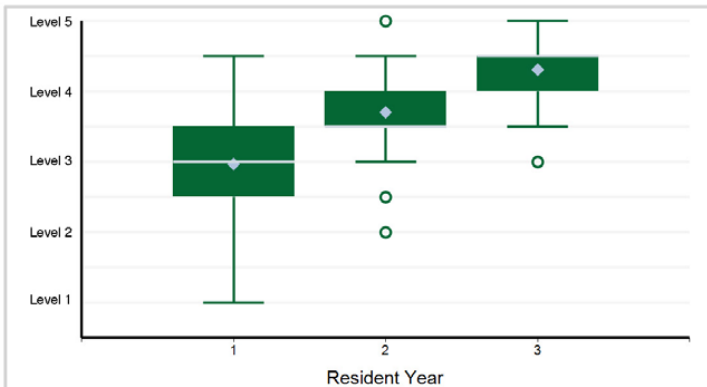

15. Professionalism - PROF1. Professional Conduct: High standards of ethical behavior which includes maintaining ...

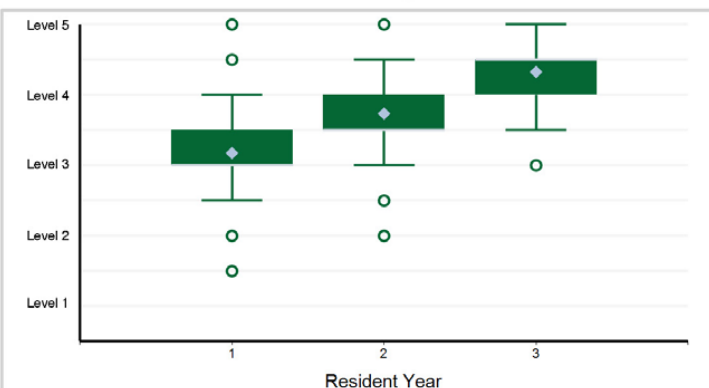

Note: 1 of 596 residents have a status of "Not Yet Assessable" and are not included in the analysis.

16. Professionalism - PROF2. Trustworthiness that makes colleagues feel secure when one is responsible for the care of patients

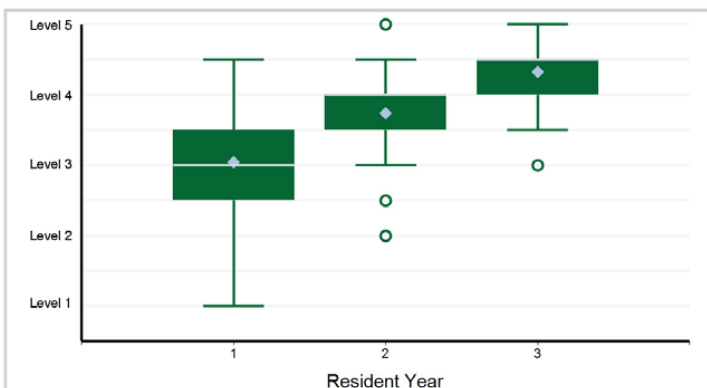

17. Professionalism - PROF3. Provide leadership skills that enhance team functioning, the learning environment, ...

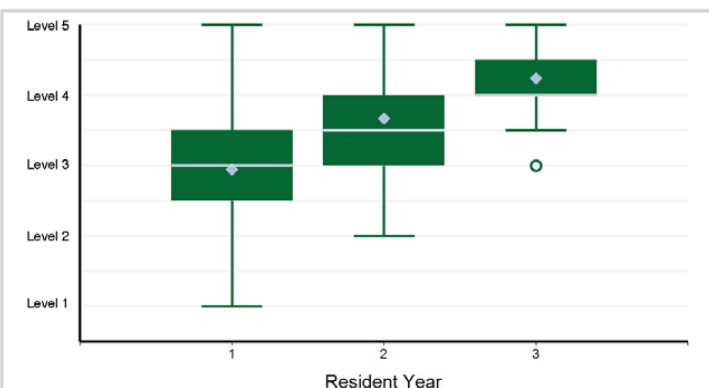

18. Professionalism - PROF4. The capacity to accept that ambiguity is part of clinical medicine and to recognize ...

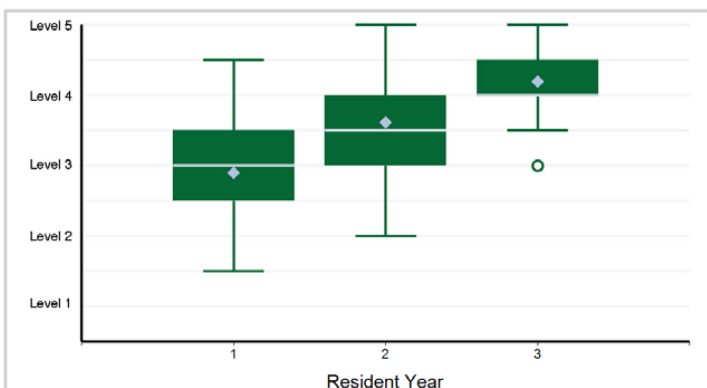

Specialty Box Plot Report - Milestone Evaluation by Resident Year: Year-End 2021-2022

SUBSPECIALTY: Pediatric Critical Care Medicine

19. Interpersonal and Communication Skills - ICS1. Communicate effectively with physicians, other health professionals, and ...

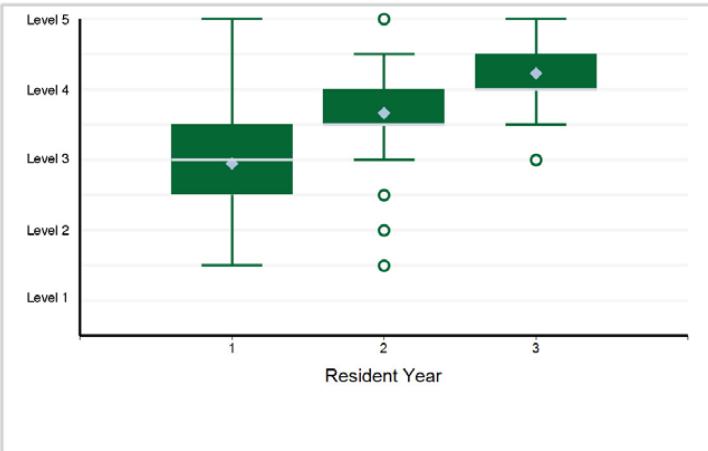

20. Interpersonal and Communication Skills - ICS2. Work effectively as a member or leader of a health care ...

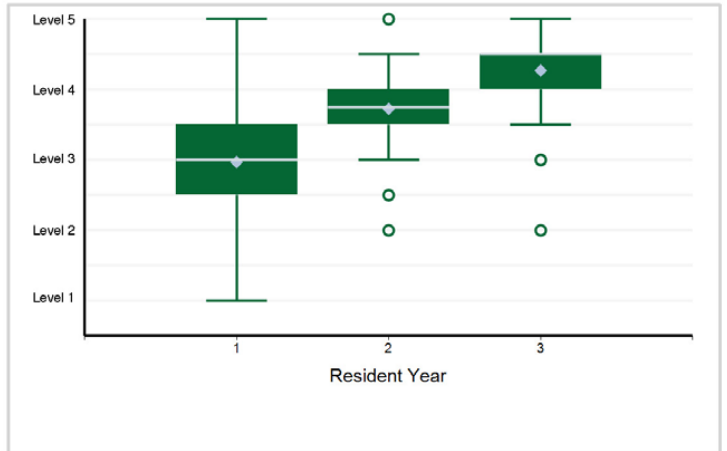

21. Interpersonal and Communication Skills - ICS3. Act in a consultative role to other physicians and health professionals

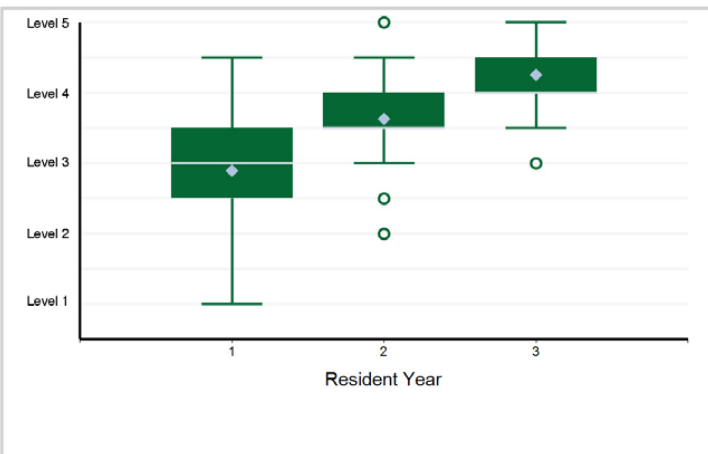

Specialty Box Plot Report - Milestone Evaluation by Resident Year: Year-End 2021-2022

TABLE 101: SUBSPECIALTY: **Pediatric Emergency Medicine (multidisciplinary, Pediatrics)**

Resident Year	1	2	3	Total Residents
# of Residents	154	150	142	446

1. Patient Care - Gather essential and accurate information about the patient: Abstracts current findings ...

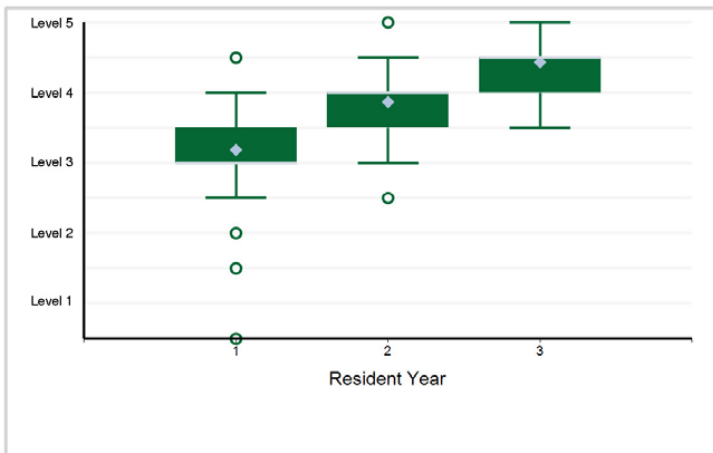

2. Patient Care - Organize and prioritize responsibilities to provide patient care that is safe, effective, ...

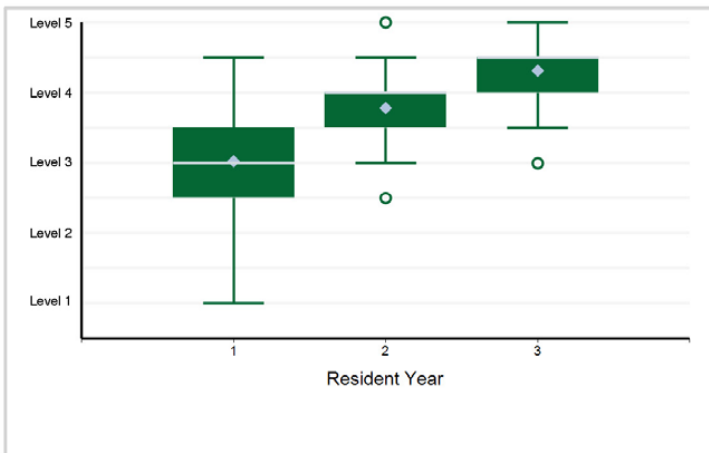

3. Patient Care - Provide transfer of care that ensures seamless transitions — PC3

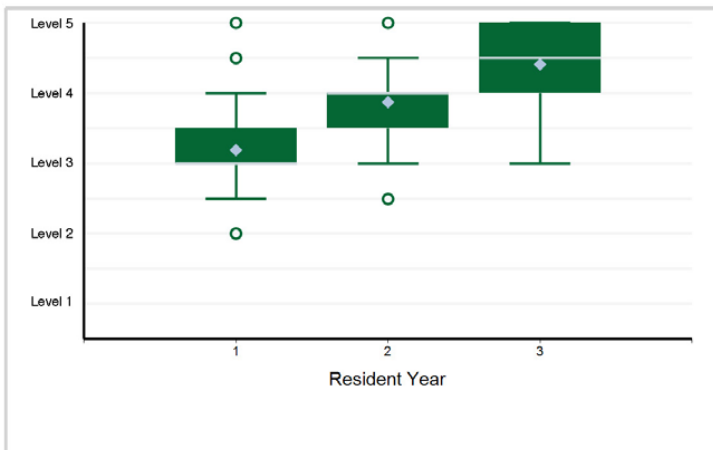

4. Patient Care - Make informed diagnostic and therapeutic decisions that result in optimal clinical judgment — PC4

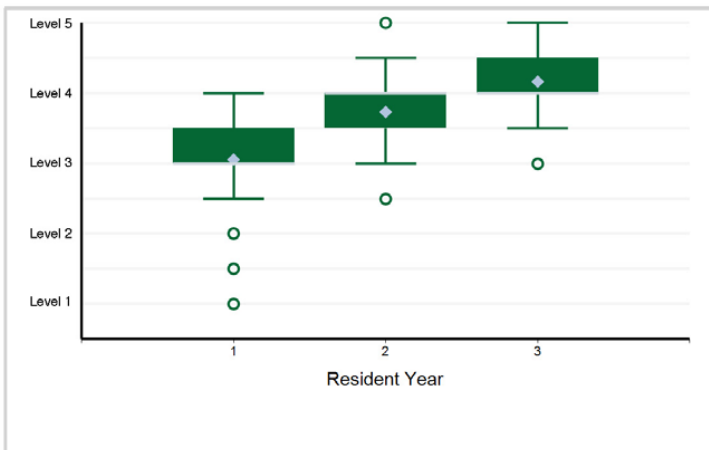

5. Patient Care - Emergency Stabilization: Prioritizes critical initial stabilization action and mobilizes ...

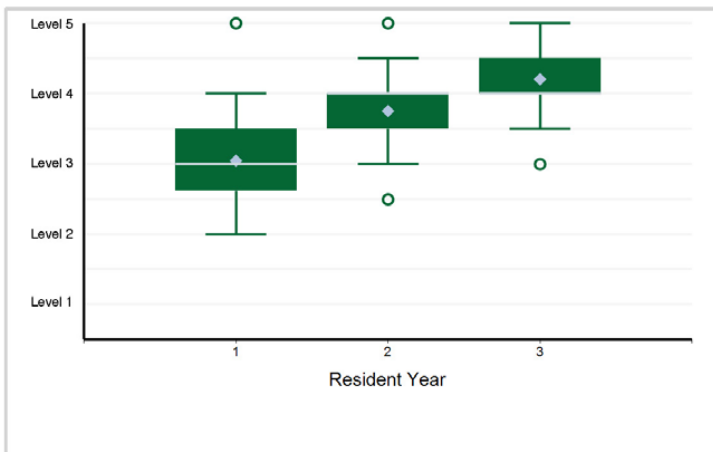

6. Patient Care - Diagnostic Studies: Applies the results of diagnostic testing based on the probability ...

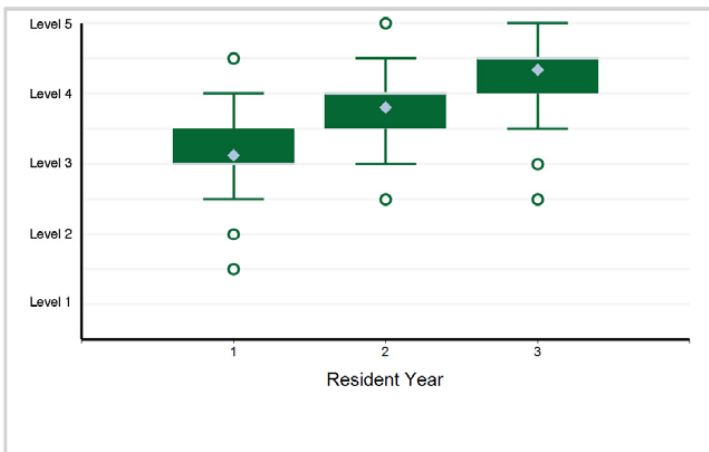

Specialty Box Plot Report - Milestone Evaluation by Resident Year: Year-End 2021-2022

SUBSPECIALTY: Pediatric Emergency Medicine (multidisciplinary, Pediatrics)

7. Patient Care - Observation and Reassessment: Re-evaluates patients undergoing emergency department (ED) ...

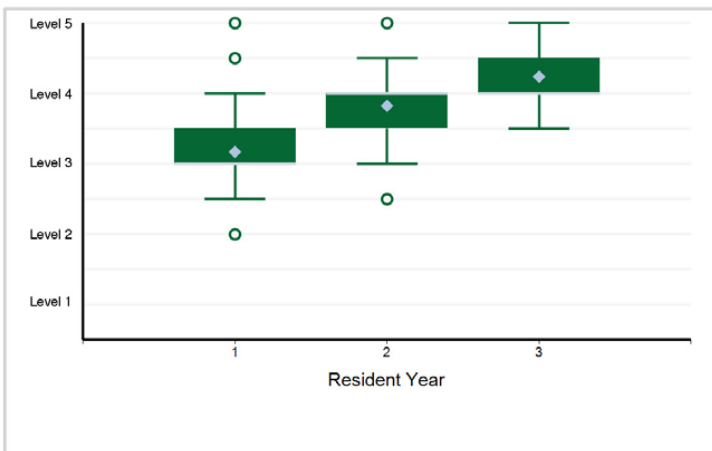

8. Patient Care - Disposition: Establishes and implements a comprehensive disposition plan that uses appropriate ...

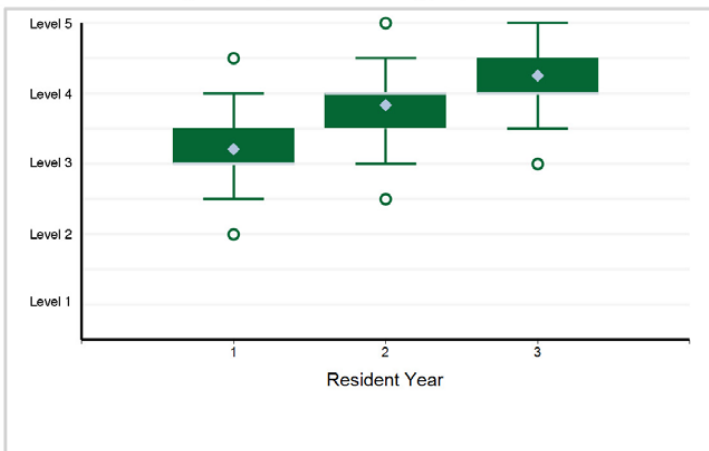

9. Patient Care - General Approach to Procedures: Performs the indicated procedure on all appropriate patients ...

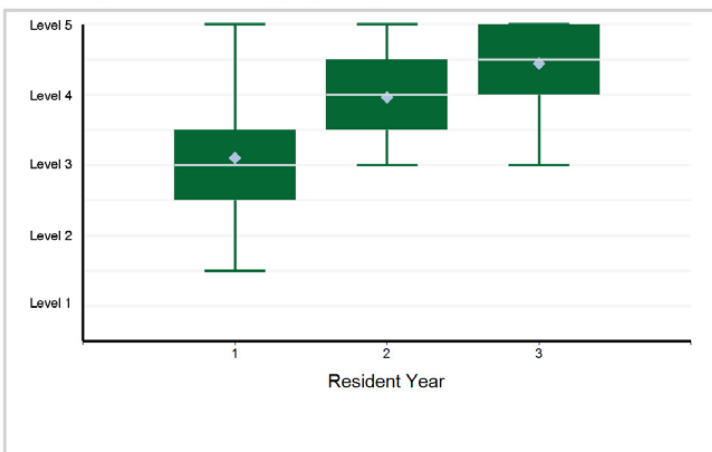

10. Patient Care - Anesthesia and Acute Pain Management: Provides safe acute pain management, anesthesia, ...

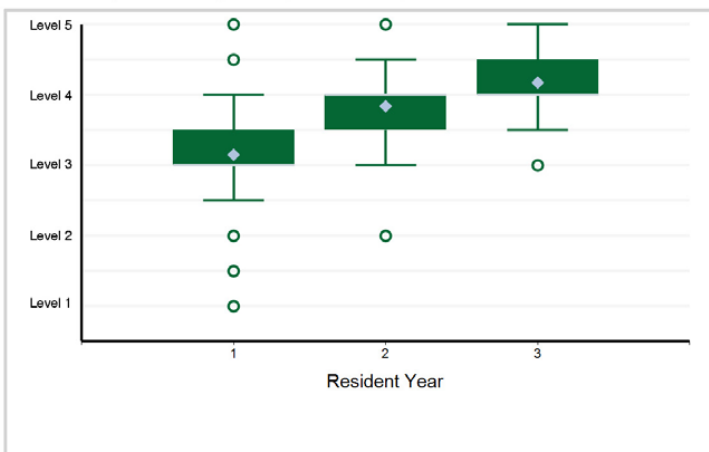

11. Patient Care - Provide appropriate supervision (milestones for the supervisor) — PC11

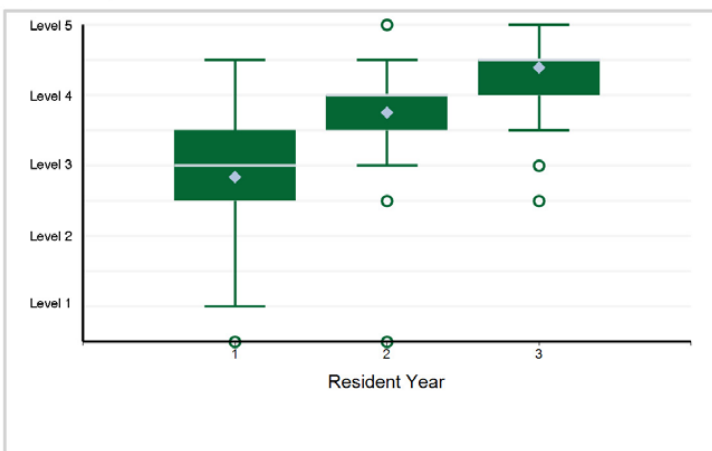

12. Medical Knowledge - Demonstrate sufficient knowledge of the basic and clinically supportive sciences ...

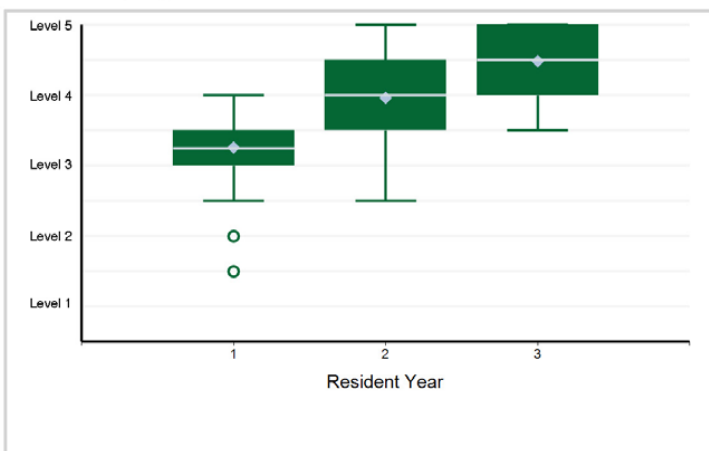

Specialty Box Plot Report - Milestone Evaluation by Resident Year: Year-End 2021-2022

SUBSPECIALTY: Pediatric Emergency Medicine (multidisciplinary, Pediatrics)

13. Systems-Based Practice - Advocate for quality patient care and optimal patient care systems — SBP1

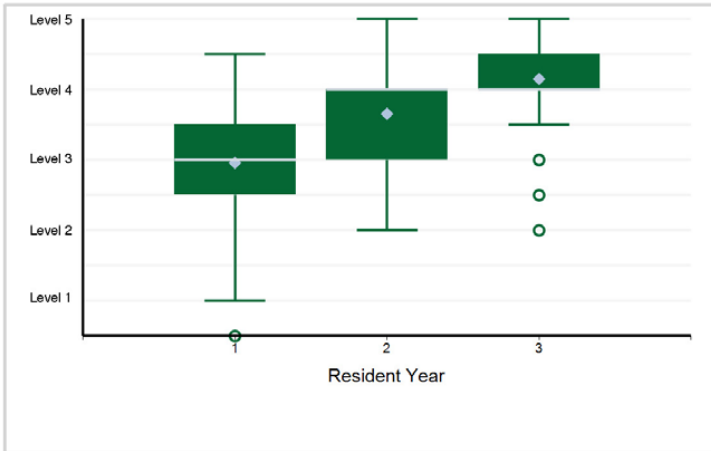

14. Systems-Based Practice - Participate in identifying system errors and implementing potential systems solutions — SBP2

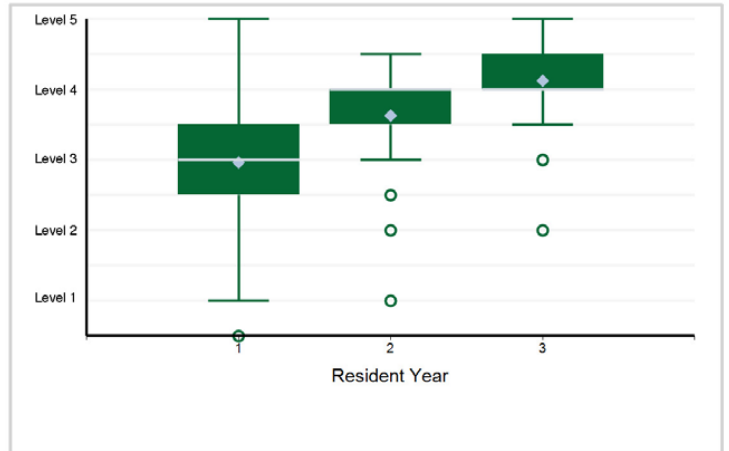

15. Practice-Based Learning and Improvement - Use information technology to optimize learning and care delivery — PBL1

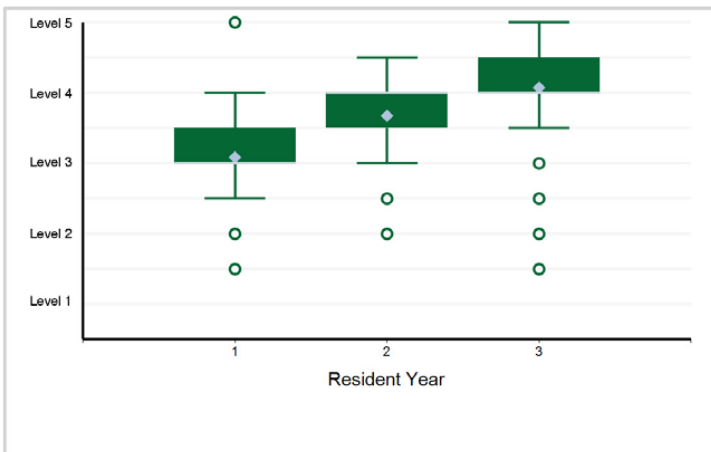

16. Professionalism - Self-awareness of one's own knowledge, skill, and emotional limitations that leads ...

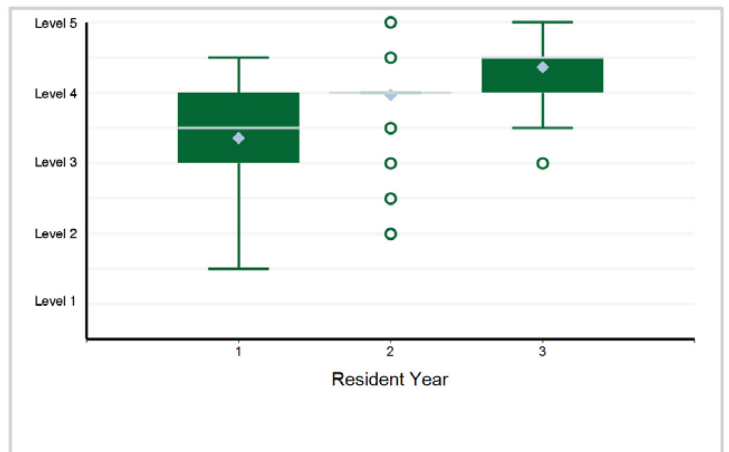

17. Professionalism - The capacity to accept that ambiguity is part of clinical medicine and to recognize ...

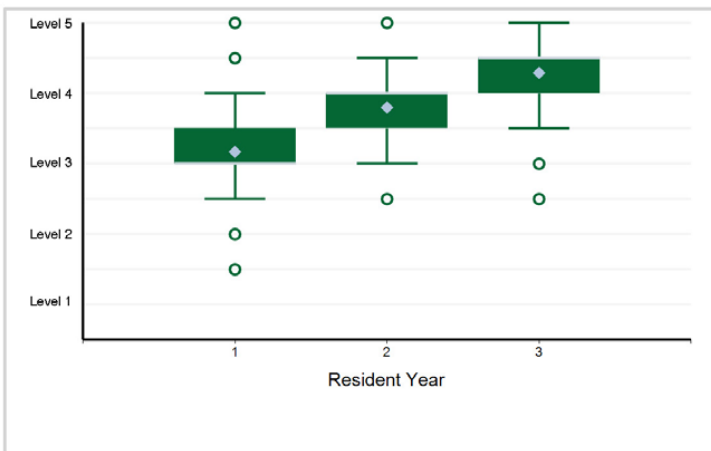

18. Professionalism - Practice flexibility and maturity in adjusting to change with the capacity to alter behavior — PROF3

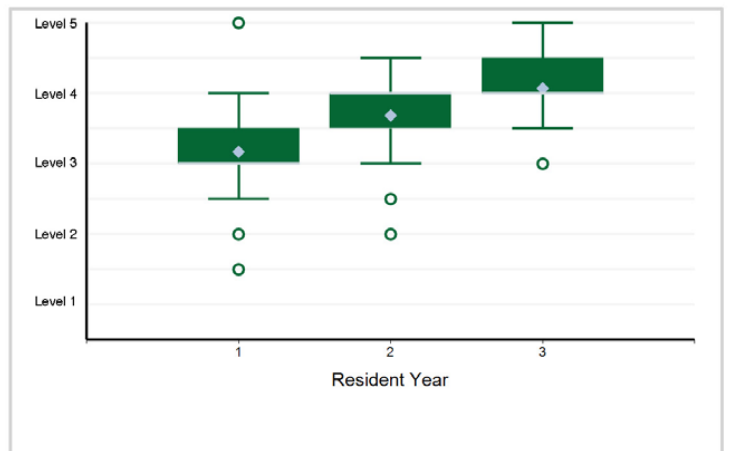

Specialty Box Plot Report - Milestone Evaluation by Resident Year: Year-End 2021-2022

SUBSPECIALTY: Pediatric Emergency Medicine (multidisciplinary, Pediatrics)

19. Professionalism - Provide leadership skills that enhance team functioning, the learning environment, ...

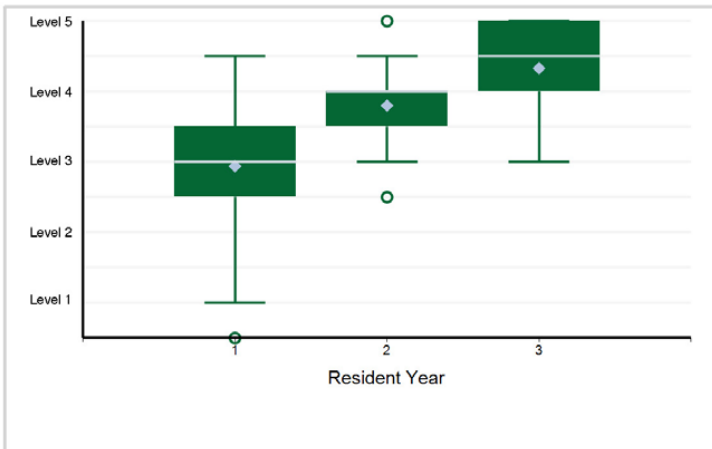

20. Professionalism - Demonstrate self-confidence that puts patients, families, and members of the health care team at ease ...

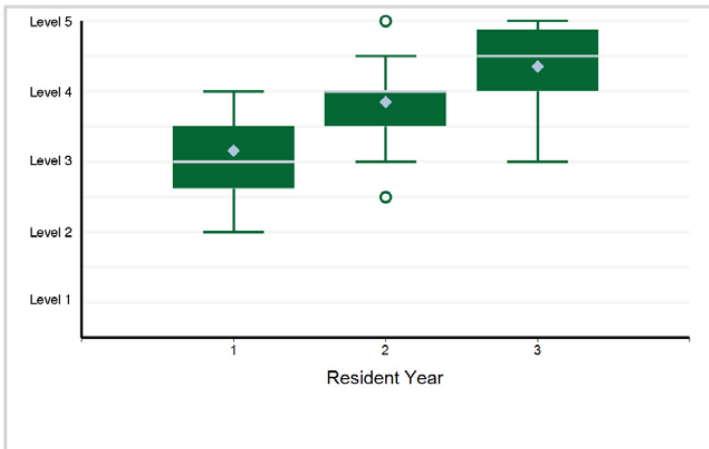

21. Interpersonal and Communication Skills - Communicate effectively with patients, families, and the public, ...

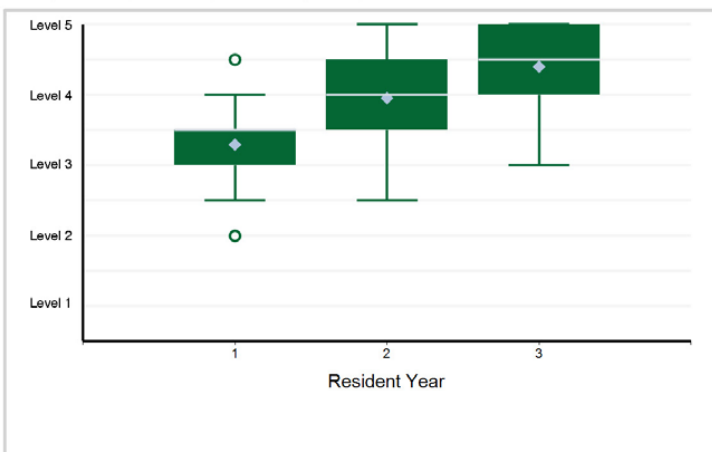

22. Interpersonal and Communication Skills - Demonstrate the insight and understanding into emotion and ...

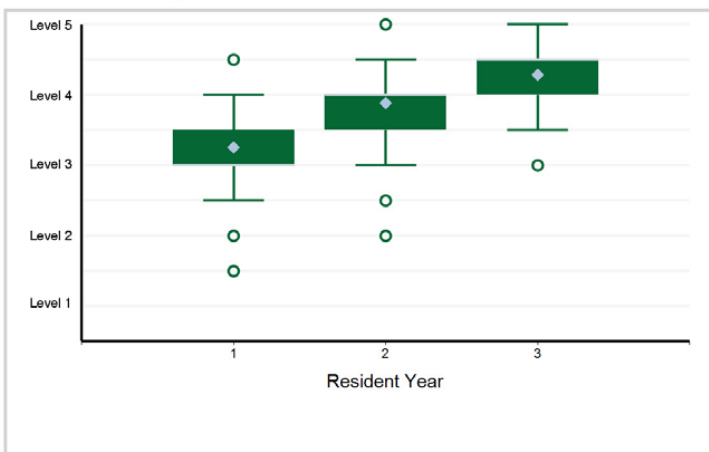

23. Interpersonal and Communication Skills - Act in a consultative role to other physicians and health professionals — ICS3

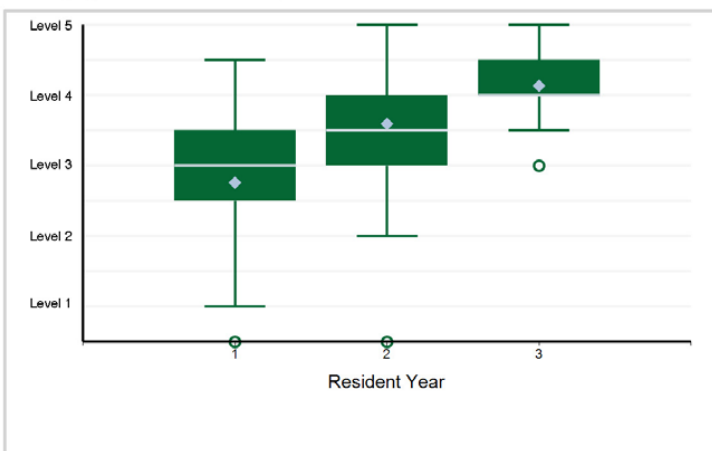

Specialty Box Plot Report - Milestone Evaluation by Resident Year: Year-End 2021-2022

TABLE 102: SUBSPECIALTY: **Pediatric Endocrinology**

Resident Year	1	2	3	Total Residents*
# of Residents	85	86	63	234

*Note: There are 3 residents with an incomplete milestone evaluation that are excluded from the box plots below.

1. Patient Care - PC1. Provide transfer of care that ensures seamless transitions

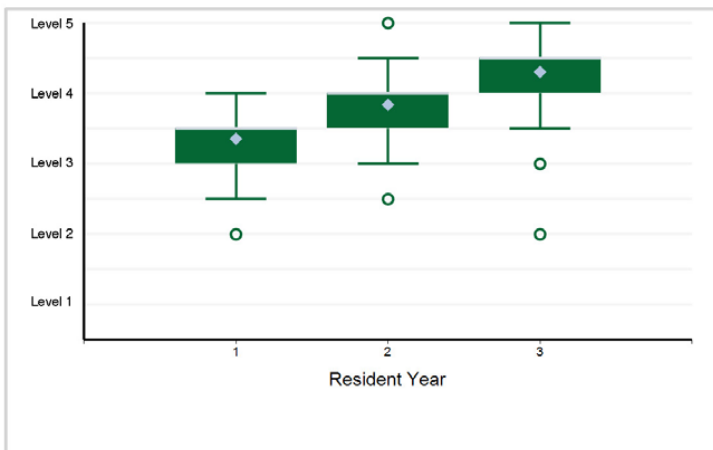

2. Patient Care - PC2. Make informed diagnostic and therapeutic decisions that result in optimal clinical judgment

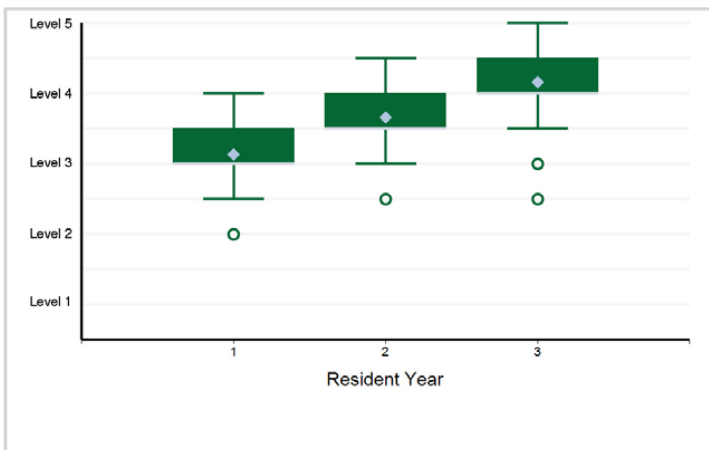

3. Patient Care - PC3. Develop and carry out management plans

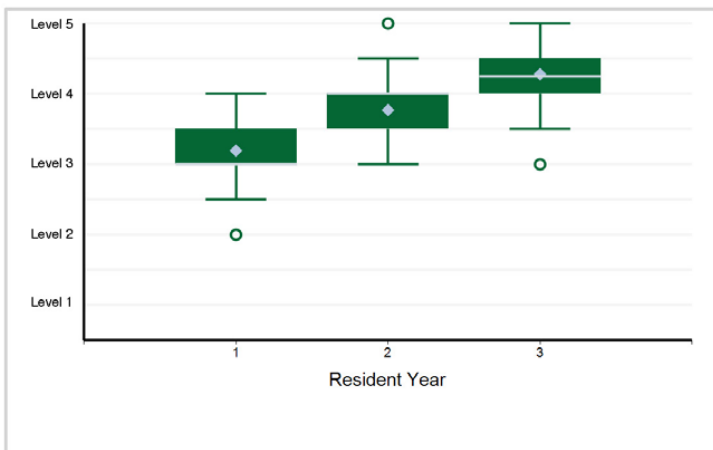

4. Patient Care - PC4. Provide appropriate role modeling

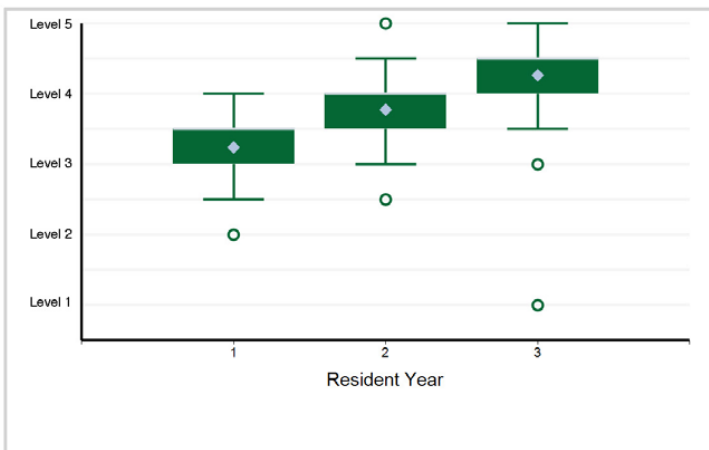

5. Medical Knowledge - MK1. Locate, appraise, and assimilate evidence from scientific studies related to ...

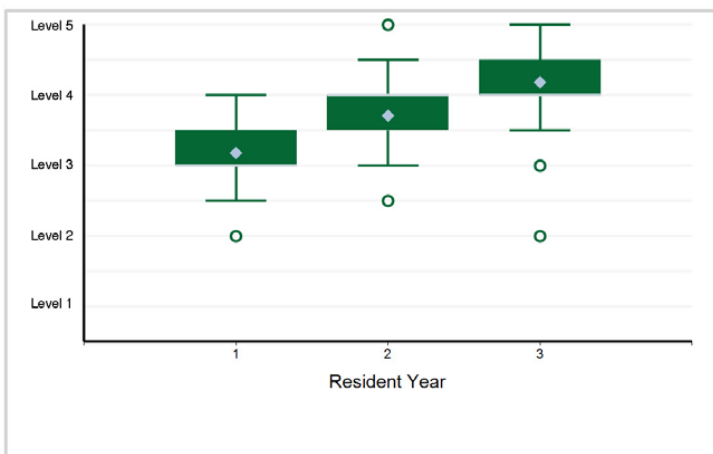

6. Systems-Based Practice - SBP1. Work effectively in various health care delivery settings and systems ...

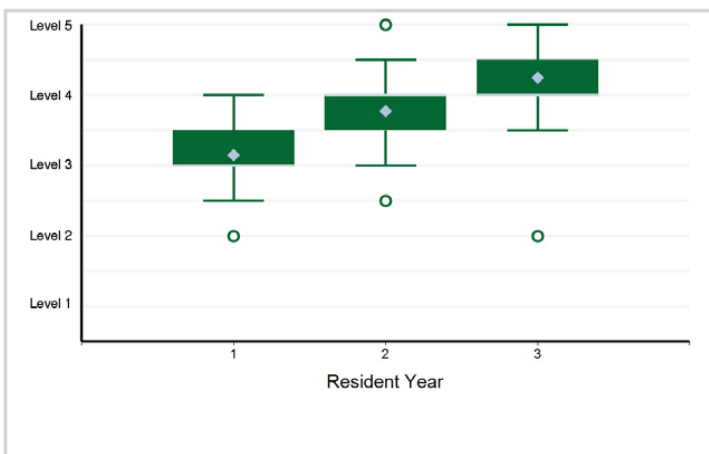

Specialty Box Plot Report - Milestone Evaluation by Resident Year: Year-End 2021-2022

SUBSPECIALTY: Pediatric Endocrinology

7. Systems-Based Practice - SBP2. Coordinate patient care within the health care system relevant to their clinical specialty

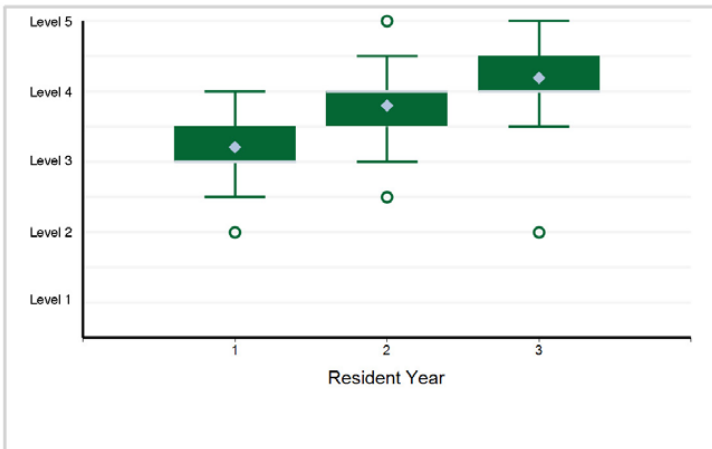

8. Systems-Based Practice - SBP3. Incorporate considerations of cost awareness and risk-benefit analysis in patient and/or ...

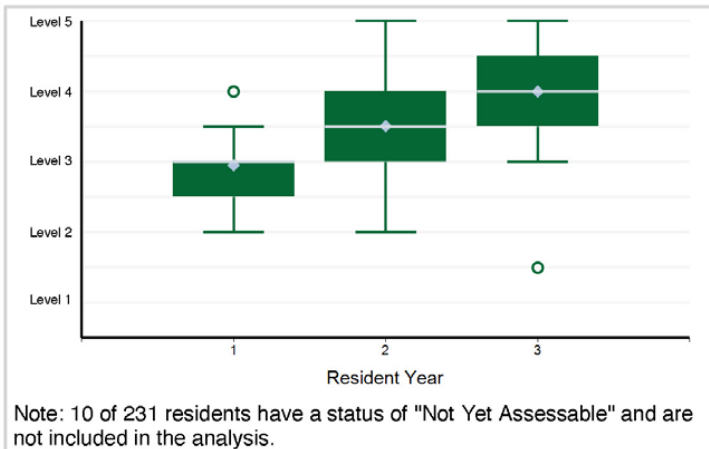

9. Systems-Based Practice - SBP4. Work in interprofessional teams to enhance patient safety and improve patient care quality

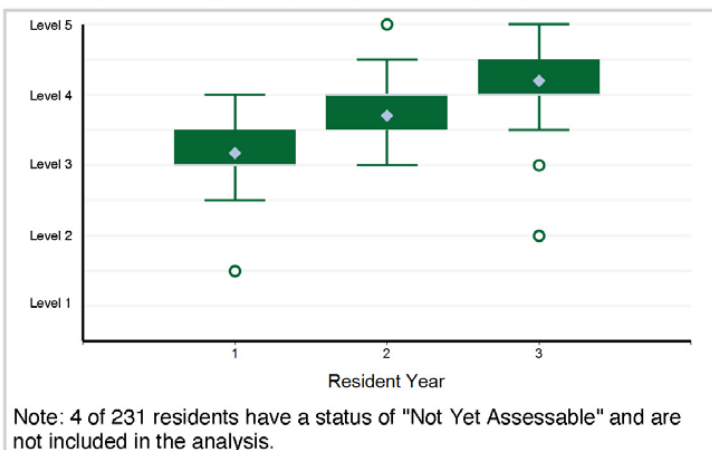

10. Systems-Based Practice - SBP5. Participate in identifying system errors and implementing potential systems solutions

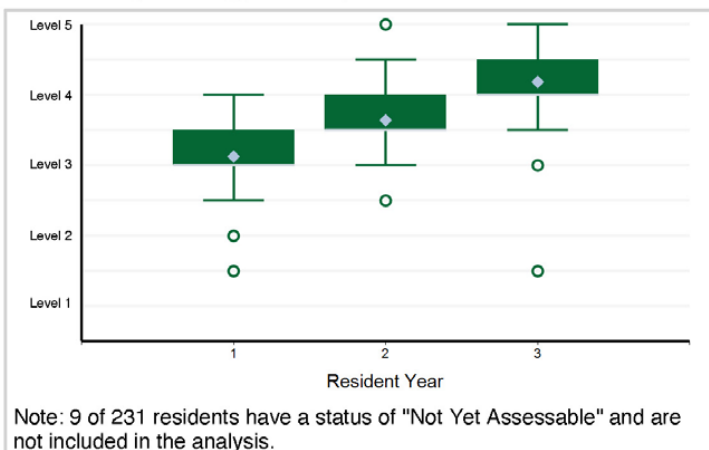

11. Practice-Based Learning and Improvement - PBLI1. Identify strengths, deficiencies, and limits in one's knowledge and expertise

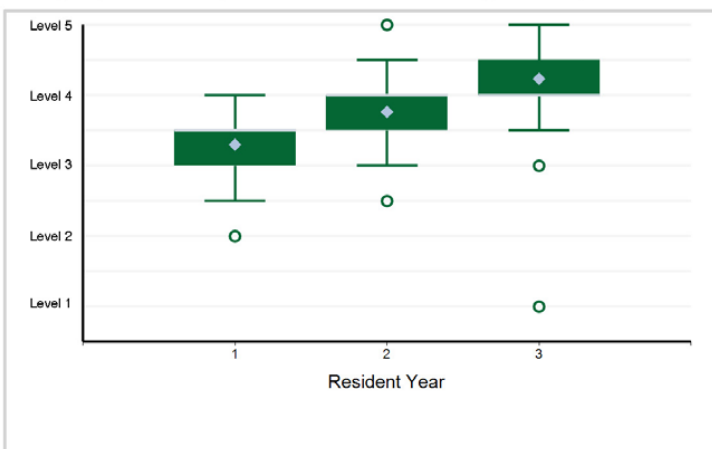

12. Practice-Based Learning and Improvement - PBLI2. Systematically analyze practice using quality improvement methods, and ...

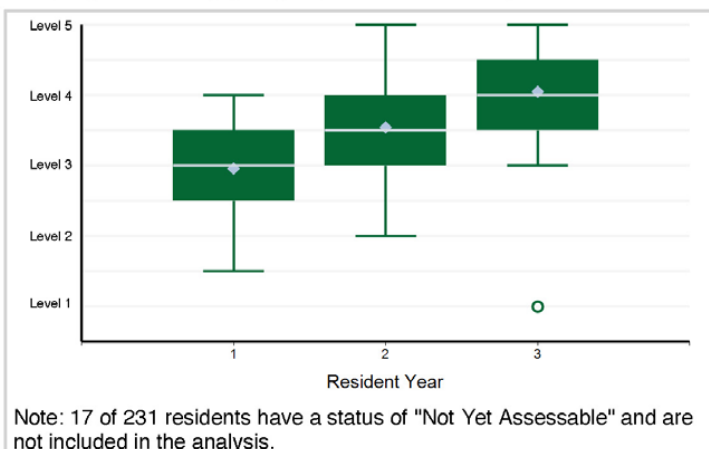

Specialty Box Plot Report - Milestone Evaluation by Resident Year: Year-End 2021-2022

SUBSPECIALTY: Pediatric Endocrinology

13. Practice-Based Learning and Improvement - PBLI3. Use information technology to optimize learning and care delivery

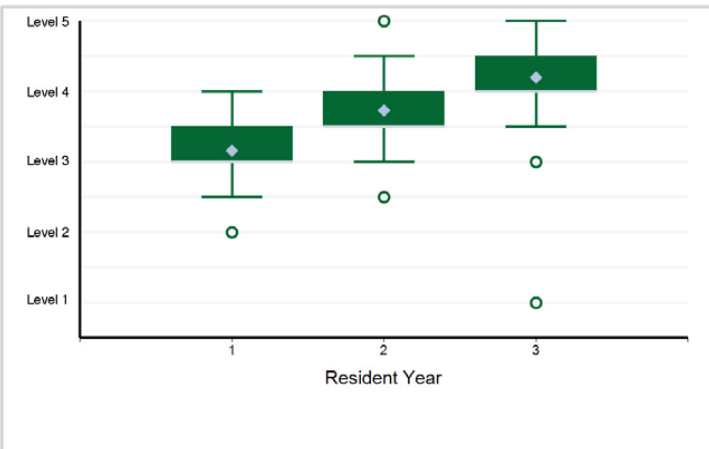

14. Practice-Based Learning and Improvement - PBLI4. Participate in the education of patients, families, ...

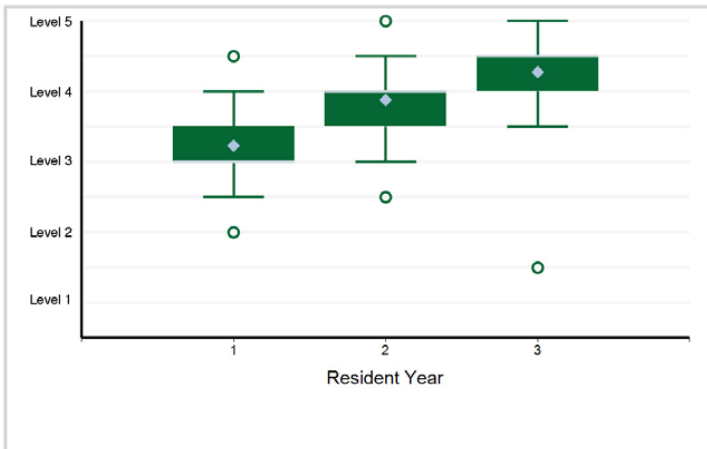

15. Professionalism - PROF1. Professional Conduct: High standards of ethical behavior which includes maintaining ...

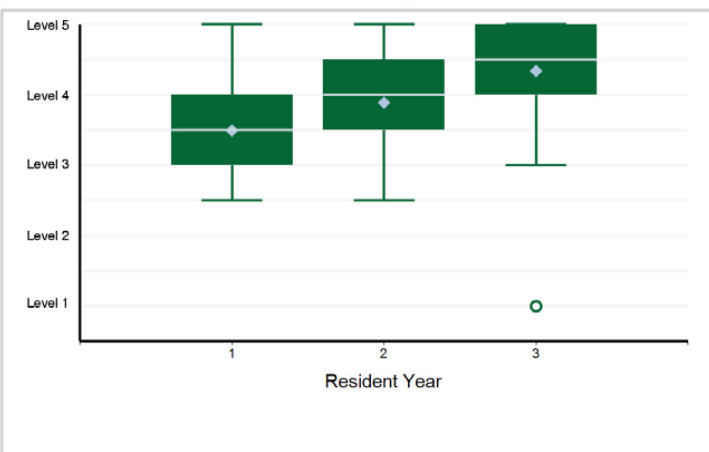

16. Professionalism - PROF2. Trustworthiness that makes colleagues feel secure when one is responsible for the care of patients

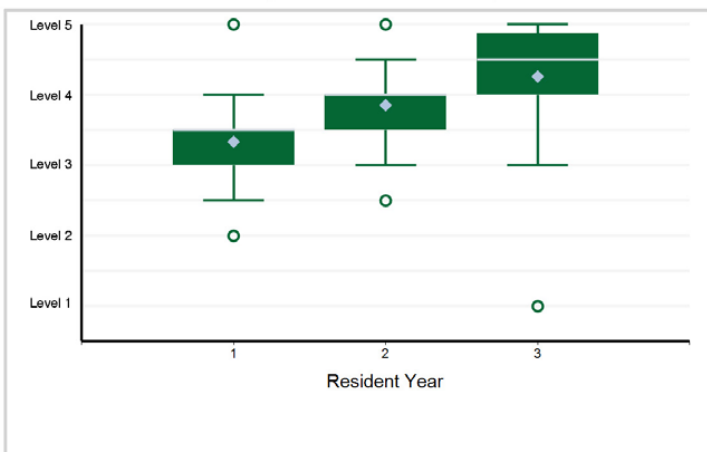

17. Professionalism - PROF3. Provide leadership skills that enhance team functioning, the learning environment, ...

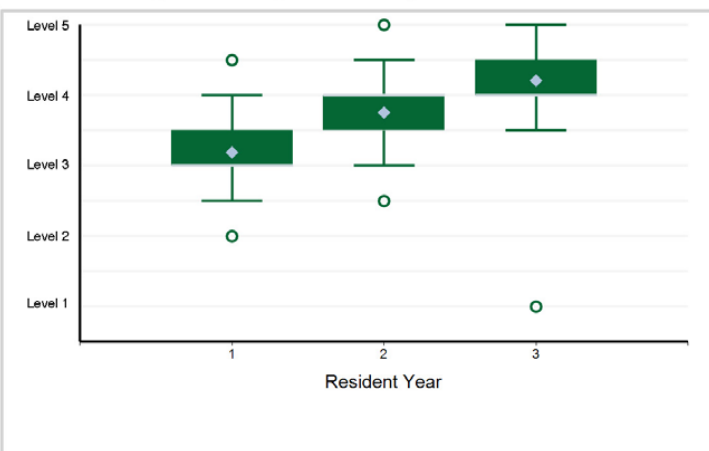

18. Professionalism - PROF4. The capacity to accept that ambiguity is part of clinical medicine and to recognize ...

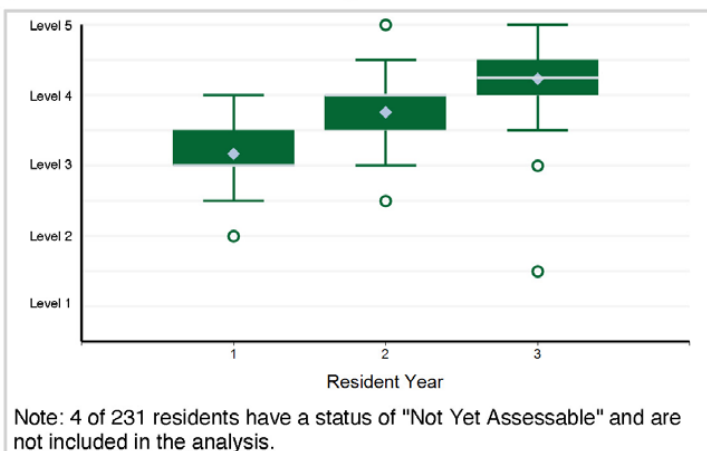

Note: 4 of 231 residents have a status of "Not Yet Assessable" and are not included in the analysis.

Specialty Box Plot Report - Milestone Evaluation by Resident Year: Year-End 2021-2022

SUBSPECIALTY: Pediatric Endocrinology

19. Interpersonal and Communication Skills - ICS1. Communicate effectively with physicians, other health professionals, and ...

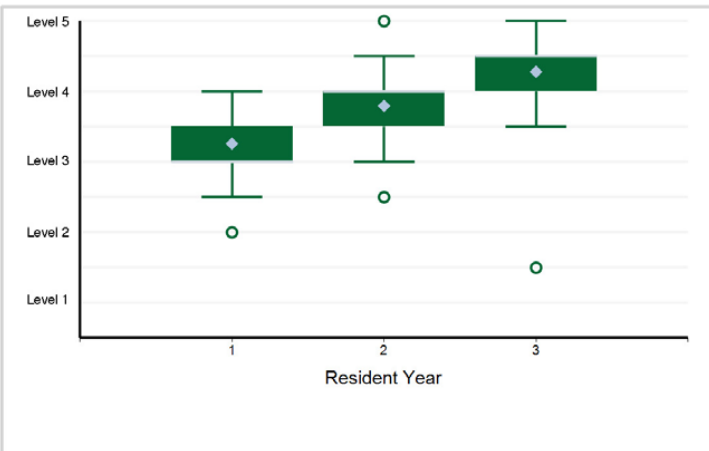

20. Interpersonal and Communication Skills - ICS2. Work effectively as a member or leader of a health care ...

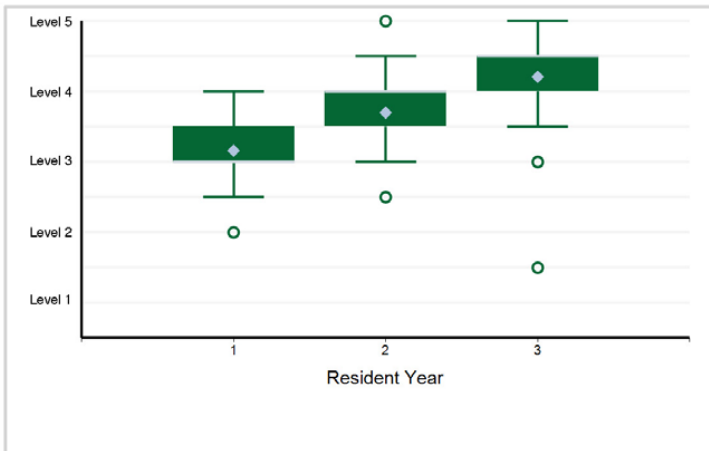

21. Interpersonal and Communication Skills - ICS3. Act in a consultative role to other physicians and health professionals

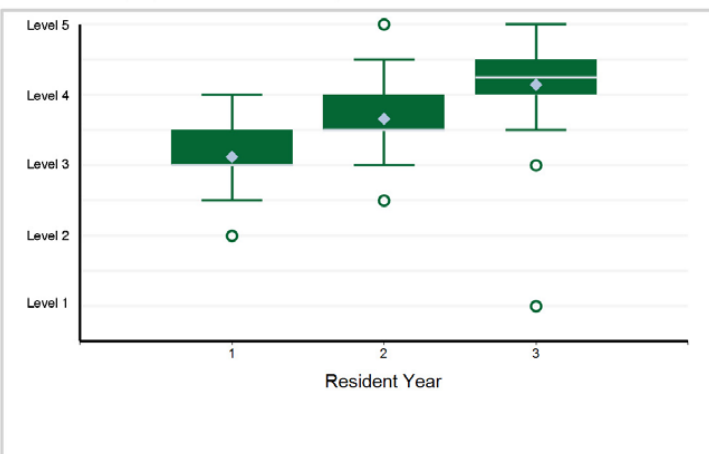

Specialty Box Plot Report - Milestone Evaluation by Resident Year: Year-End 2021-2022

TABLE 103: SUBSPECIALTY: **Pediatric Gastroenterology**

Resident Year	1	2	3	Total Residents
# of Residents	112	110	110	332

1. Patient Care - PC1. Provide transfer of care that ensures seamless transitions

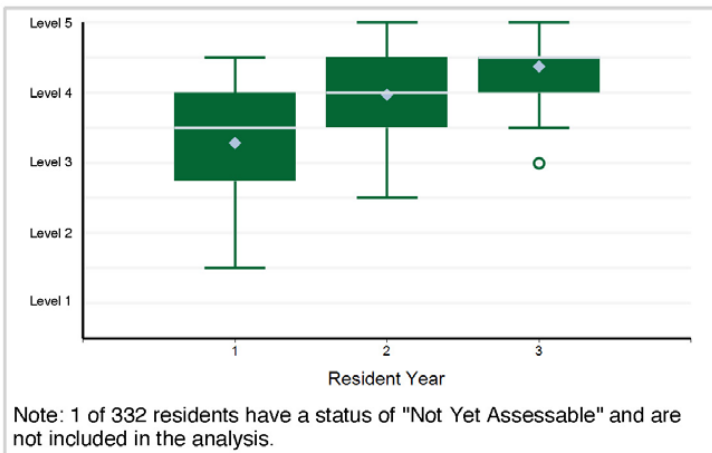

2. Patient Care - PC2. Make informed diagnostic and therapeutic decisions that result in optimal clinical judgment

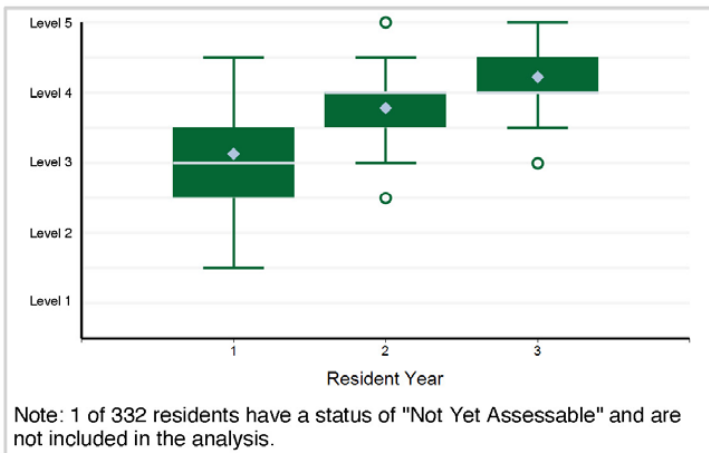

3. Patient Care - PC3. Develop and carry out management plans

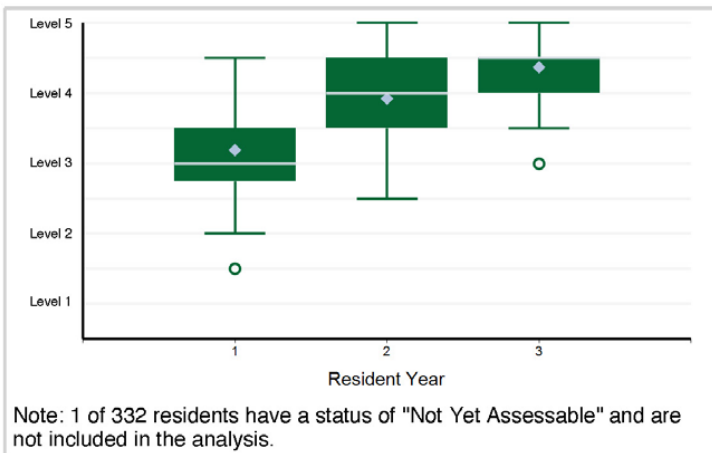

4. Patient Care - PC4. Provide appropriate role modeling

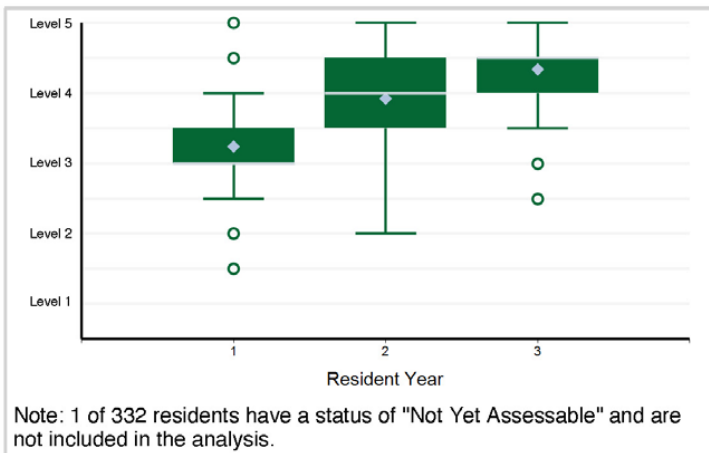

5. Medical Knowledge - MK1. Locate, appraise, and assimilate evidence from scientific studies related to ...

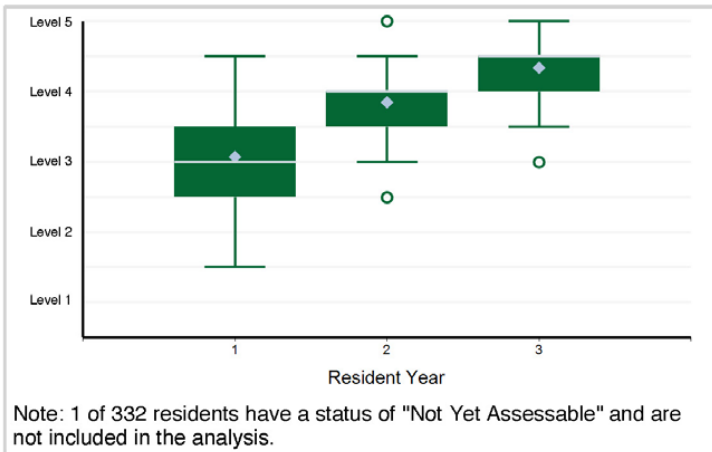

6. Systems-Based Practice - SBP1. Work effectively in various health care delivery settings and systems ...

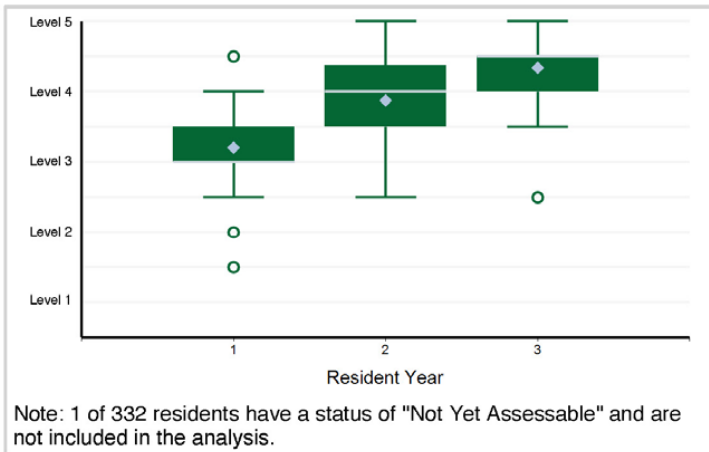

Specialty Box Plot Report - Milestone Evaluation by Resident Year: Year-End 2021-2022

SUBSPECIALTY: Pediatric Gastroenterology

7. Systems-Based Practice - SBP2. Coordinate patient care within the health care system relevant to their clinical specialty

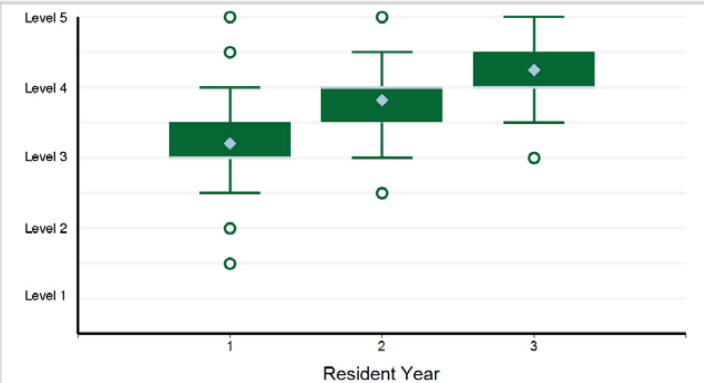

Note: 1 of 332 residents have a status of "Not Yet Assessable" and are not included in the analysis.

8. Systems-Based Practice - SBP3. Incorporate considerations of cost awareness and risk-benefit analysis in patient and/or ...

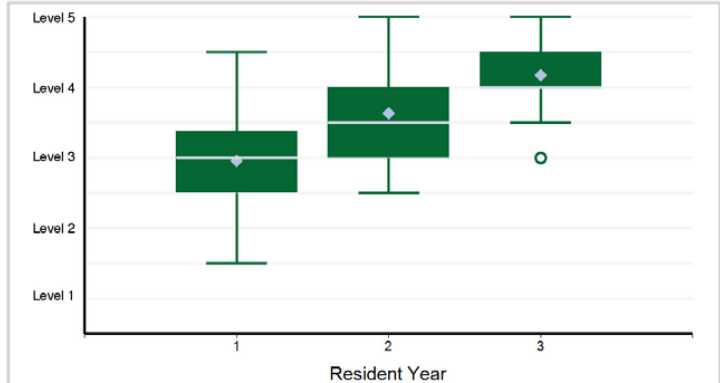

Note: 3 of 332 residents have a status of "Not Yet Assessable" and are not included in the analysis.

9. Systems-Based Practice - SBP4. Work in interprofessional teams to enhance patient safety and improve patient care quality

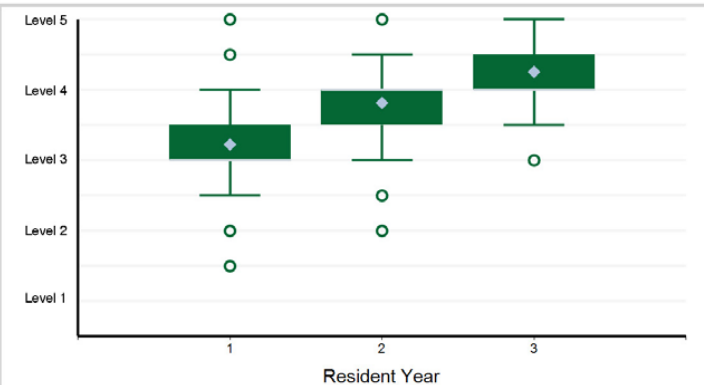

Note: 1 of 332 residents have a status of "Not Yet Assessable" and are not included in the analysis.

10. Systems-Based Practice - SBP5. Participate in identifying system errors and implementing potential systems solutions

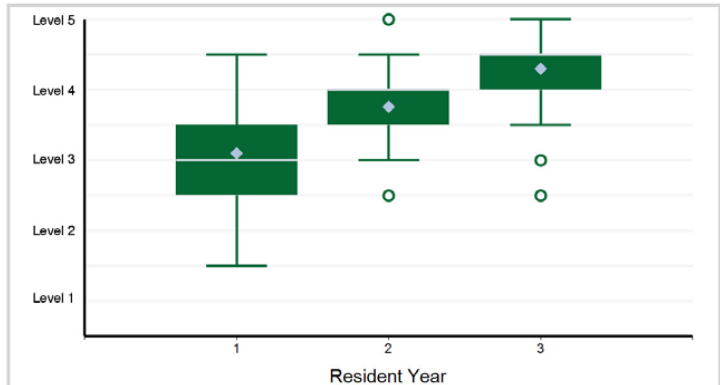

Note: 1 of 332 residents have a status of "Not Yet Assessable" and are not included in the analysis.

11. Practice-Based Learning and Improvement - PBLI1. Identify strengths, deficiencies, and limits in one's knowledge and expertise

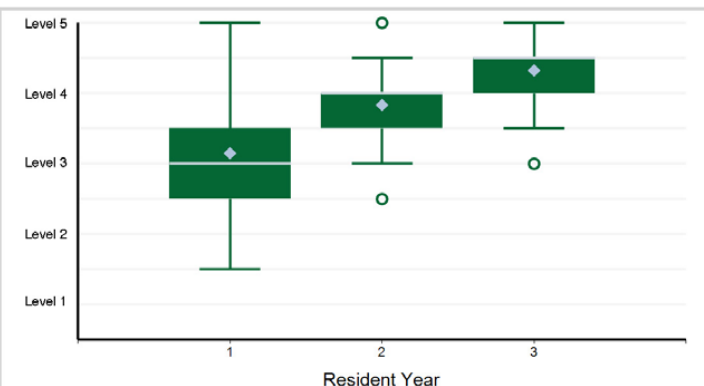

Note: 1 of 332 residents have a status of "Not Yet Assessable" and are not included in the analysis.

12. Practice-Based Learning and Improvement - PBLI2. Systematically analyze practice using quality improvement methods, and ...

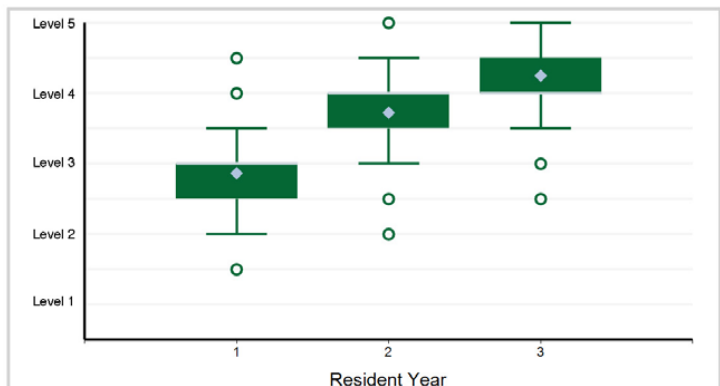

Note: 4 of 332 residents have a status of "Not Yet Assessable" and are not included in the analysis.

Specialty Box Plot Report - Milestone Evaluation by Resident Year: Year-End 2021-2022

SUBSPECIALTY: Pediatric Gastroenterology

13. Practice-Based Learning and Improvement - PBLI3. Use information technology to optimize learning and care delivery

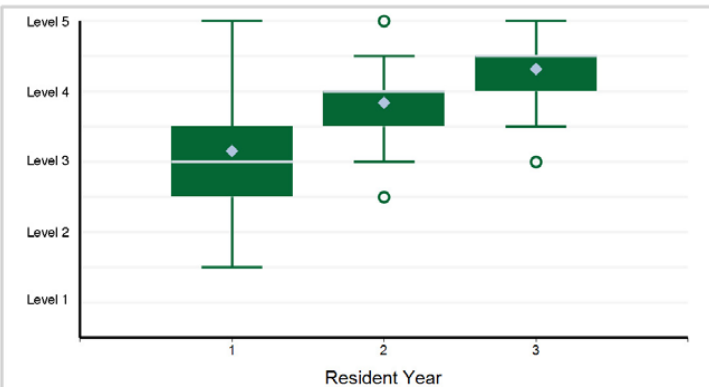

Note: 1 of 332 residents have a status of "Not Yet Assessable" and are not included in the analysis.

14. Practice-Based Learning and Improvement - PBLI4. Participate in the education of patients, families, ...

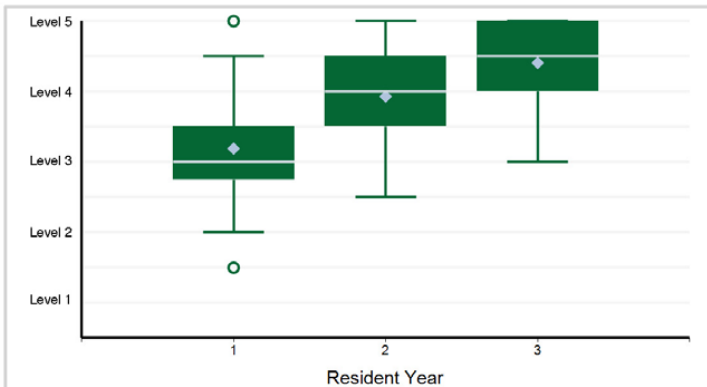

Note: 1 of 332 residents have a status of "Not Yet Assessable" and are not included in the analysis.

15. Professionalism - PROF1. Professional Conduct: High standards of ethical behavior which includes maintaining ...

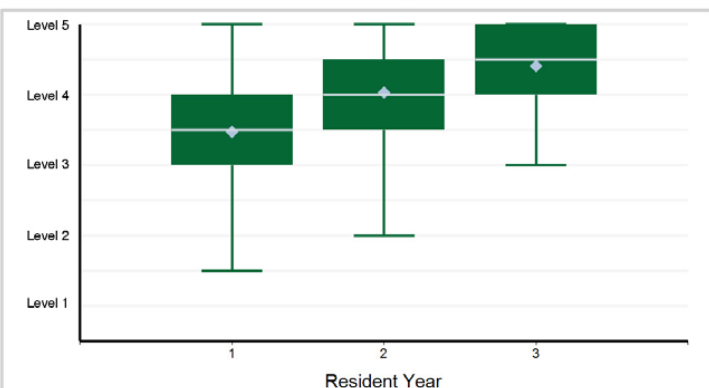

Note: 1 of 332 residents have a status of "Not Yet Assessable" and are not included in the analysis.

16. Professionalism - PROF2. Trustworthiness that makes colleagues feel secure when one is responsible for the care of patients

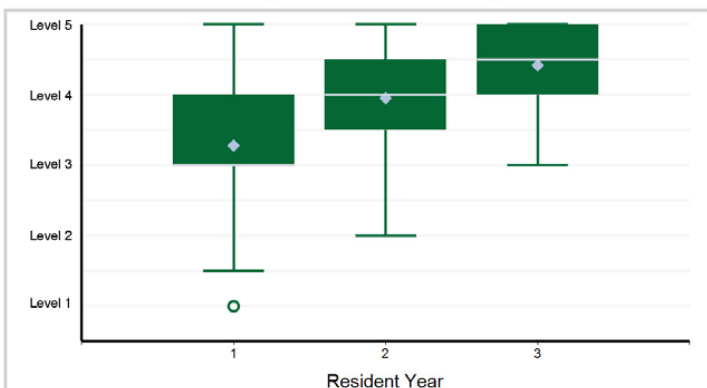

Note: 1 of 332 residents have a status of "Not Yet Assessable" and are not included in the analysis.

17. Professionalism - PROF3. Provide leadership skills that enhance team functioning, the learning environment, ...

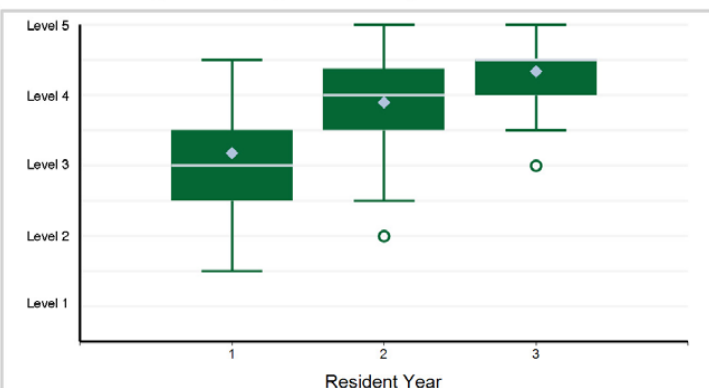

Note: 1 of 332 residents have a status of "Not Yet Assessable" and are not included in the analysis.

18. Professionalism - PROF4. The capacity to accept that ambiguity is part of clinical medicine and to recognize ...

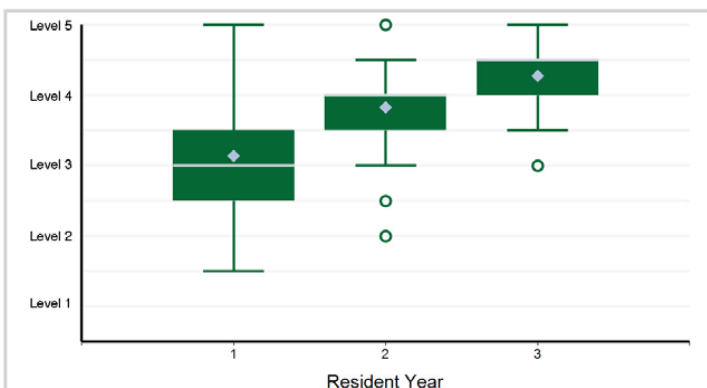

Note: 1 of 332 residents have a status of "Not Yet Assessable" and are not included in the analysis.

Specialty Box Plot Report - Milestone Evaluation by Resident Year: Year-End 2021-2022

SUBSPECIALTY: Pediatric Gastroenterology

19. Interpersonal and Communication Skills - ICS1. Communicate effectively with physicians, other health professionals, and ...

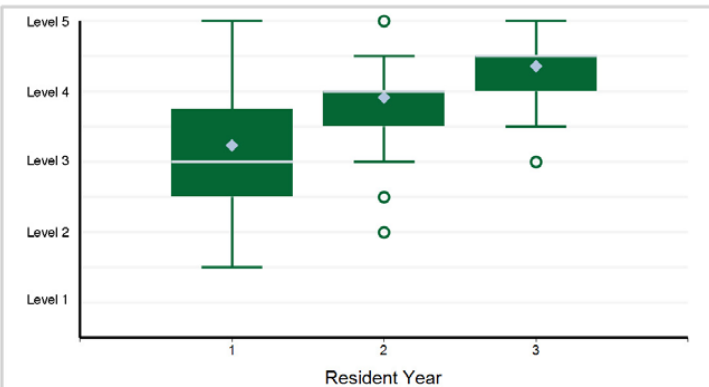

Note: 1 of 332 residents have a status of "Not Yet Assessable" and are not included in the analysis.

20. Interpersonal and Communication Skills - ICS2. Work effectively as a member or leader of a health care ...

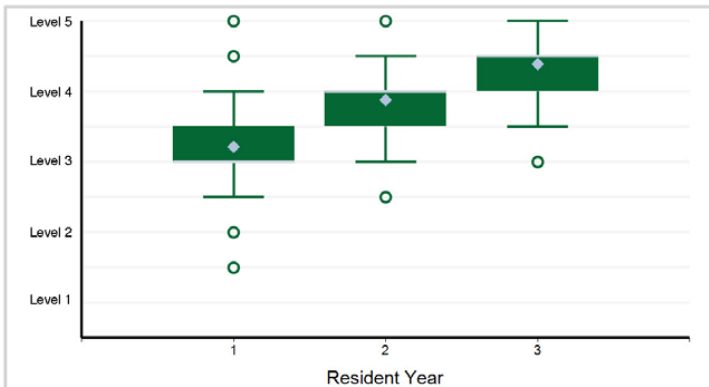

Note: 1 of 332 residents have a status of "Not Yet Assessable" and are not included in the analysis.

21. Interpersonal and Communication Skills - ICS3. Act in a consultative role to other physicians and health professionals

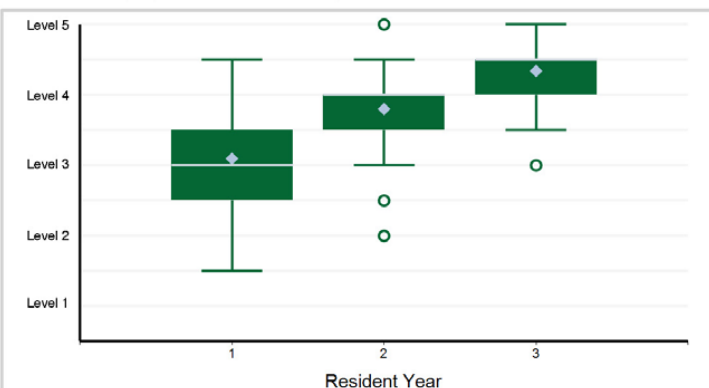

Note: 1 of 332 residents have a status of "Not Yet Assessable" and are not included in the analysis.

Specialty Box Plot Report - Milestone Evaluation by Resident Year: Year-End 2021-2022

TABLE 104: SUBSPECIALTY: **Pediatric Hematology Oncology**

Resident Year	1	2	3	Total Residents
# of Residents	167	158	162	487

1. Patient Care - PC1. Provide transfer of care that ensures seamless transitions

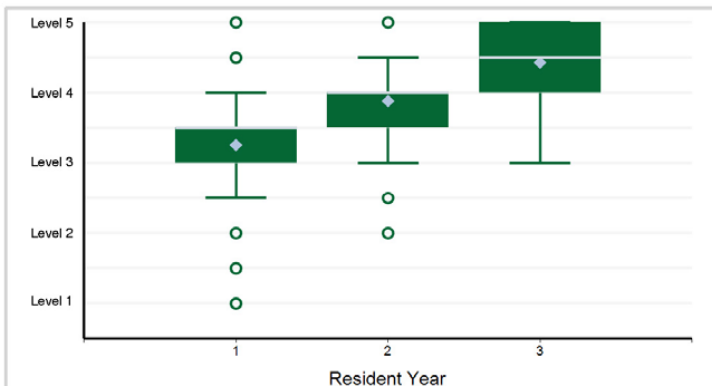

Note: 13 of 487 residents have a status of "Not Yet Assessable" and are not included in the analysis.

2. Patient Care - PC2. Make informed diagnostic and therapeutic decisions that result in optimal clinical judgment

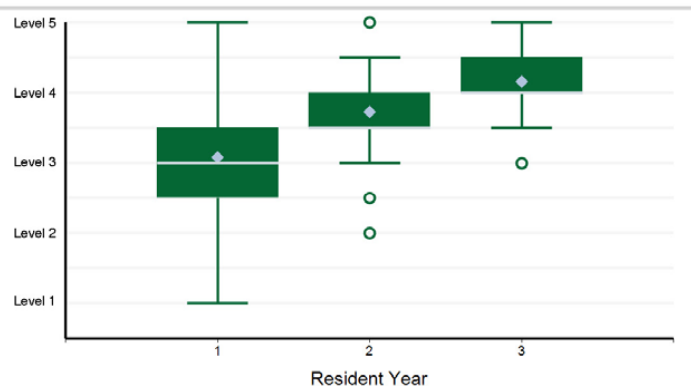

Note: 1 of 487 residents have a status of "Not Yet Assessable" and are not included in the analysis.

3. Patient Care - PC3. Develop and carry out management plans

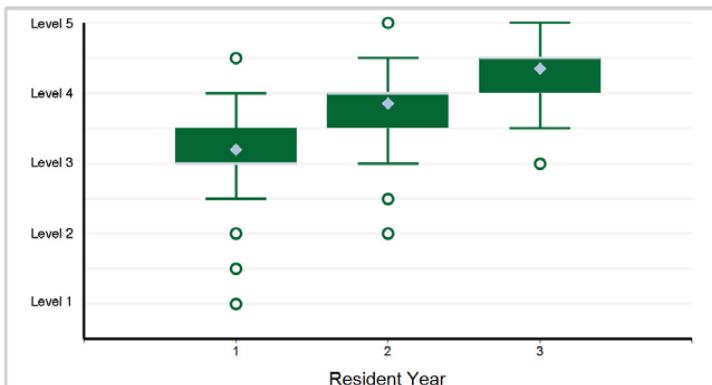

Note: 1 of 487 residents have a status of "Not Yet Assessable" and are not included in the analysis.

4. Patient Care - PC4. Provide appropriate role modeling

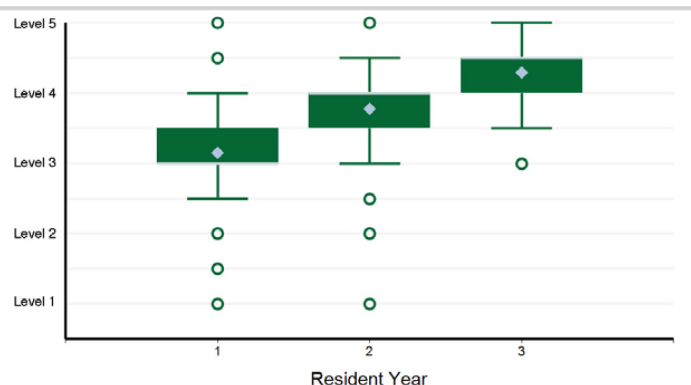

Note: 1 of 487 residents have a status of "Not Yet Assessable" and are not included in the analysis.

5. Medical Knowledge - MK1. Locate, appraise, and assimilate evidence from scientific studies related to ...

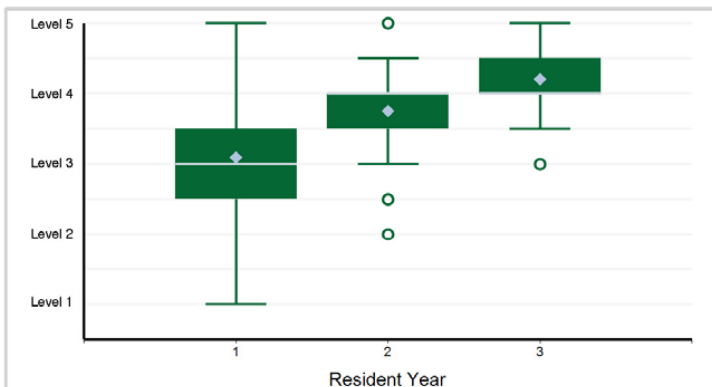

Note: 1 of 487 residents have a status of "Not Yet Assessable" and are not included in the analysis.

6. Systems-Based Practice - SBP1. Work effectively in various health care delivery settings and systems ...

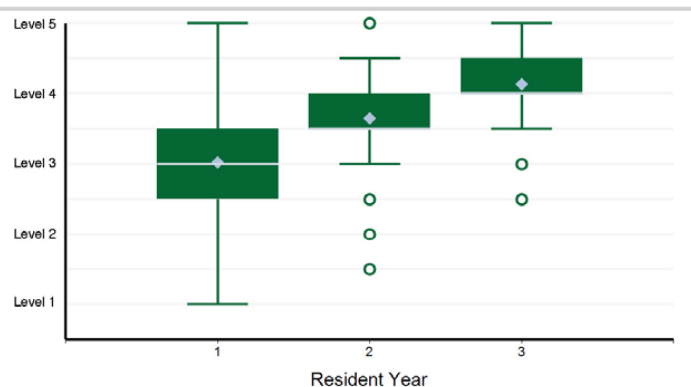

Note: 7 of 487 residents have a status of "Not Yet Assessable" and are not included in the analysis.

Specialty Box Plot Report - Milestone Evaluation by Resident Year: Year-End 2021-2022

SUBSPECIALTY: Pediatric Hematology Oncology

7. Systems-Based Practice - SBP2. Coordinate patient care within the health care system relevant to their clinical specialty

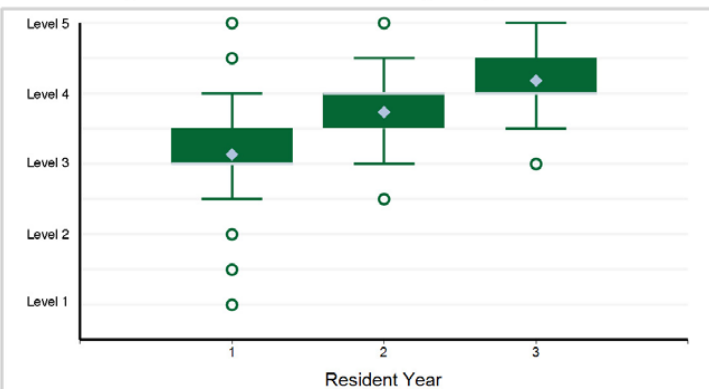

Note: 1 of 487 residents have a status of "Not Yet Assessable" and are not included in the analysis.

8. Systems-Based Practice - SBP3. Incorporate considerations of cost awareness and risk-benefit analysis in patient and/or ...

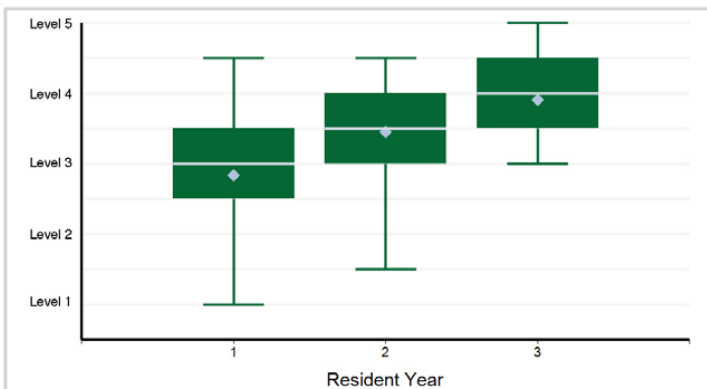

Note: 10 of 487 residents have a status of "Not Yet Assessable" and are not included in the analysis.

9. Systems-Based Practice - SBP4. Work in interprofessional teams to enhance patient safety and improve patient care quality

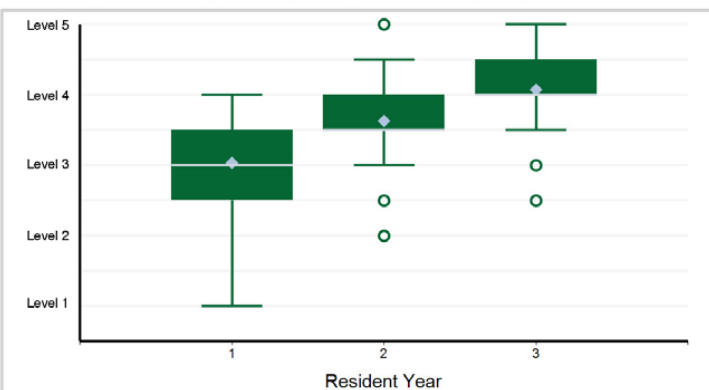

Note: 3 of 487 residents have a status of "Not Yet Assessable" and are not included in the analysis.

10. Systems-Based Practice - SBP5. Participate in identifying system errors and implementing potential systems solutions

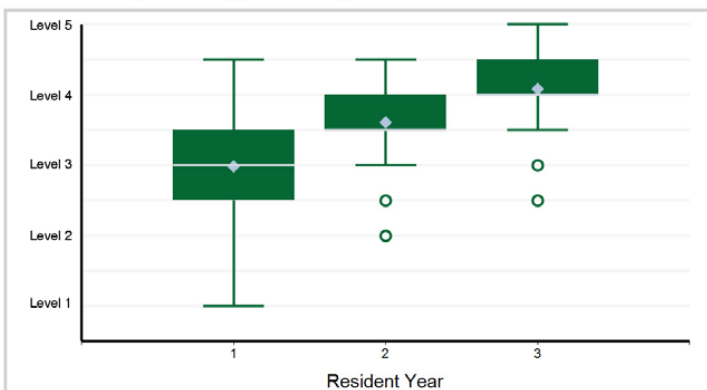

Note: 9 of 487 residents have a status of "Not Yet Assessable" and are not included in the analysis.

11. Practice-Based Learning and Improvement - PBLI1. Identify strengths, deficiencies, and limits in one's knowledge and expertise

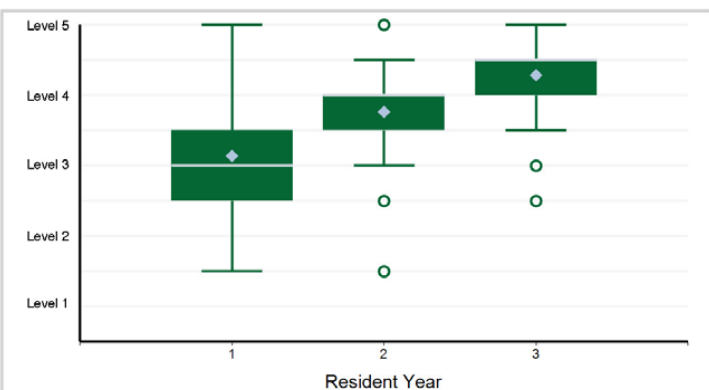

Note: 2 of 487 residents have a status of "Not Yet Assessable" and are not included in the analysis.

12. Practice-Based Learning and Improvement - PBLI2. Systematically analyze practice using quality improvement methods, and ...

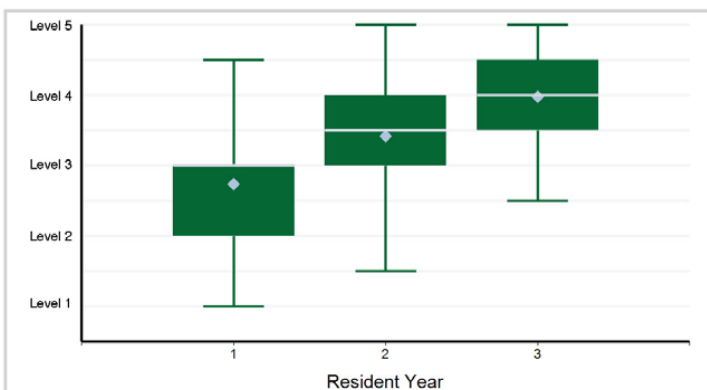

Note: 23 of 487 residents have a status of "Not Yet Assessable" and are not included in the analysis.

Specialty Box Plot Report - Milestone Evaluation by Resident Year: Year-End 2021-2022

SUBSPECIALTY: Pediatric Hematology Oncology

13. Practice-Based Learning and Improvement - PBLI3. Use information technology to optimize learning and care delivery

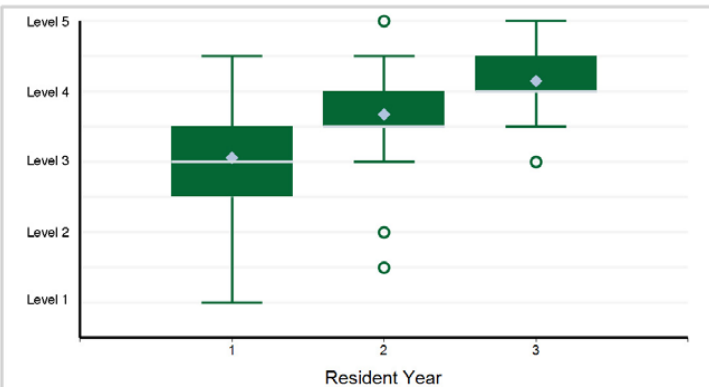

Note: 1 of 487 residents have a status of "Not Yet Assessable" and are not included in the analysis.

14. Practice-Based Learning and Improvement - PBLI4. Participate in the education of patients, families, ...

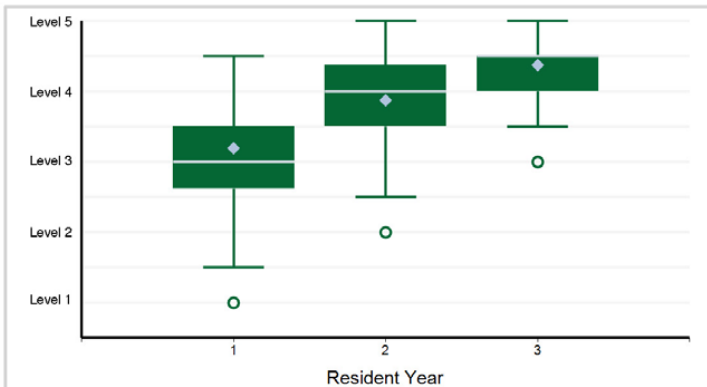

Note: 1 of 487 residents have a status of "Not Yet Assessable" and are not included in the analysis.

15. Professionalism - PROF1. Professional Conduct: High standards of ethical behavior which includes maintaining ...

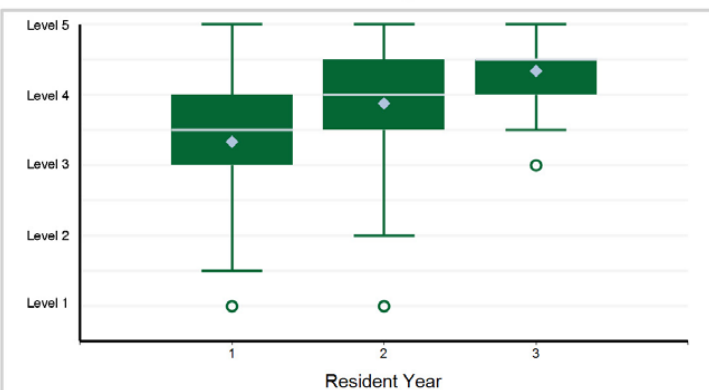

Note: 1 of 487 residents have a status of "Not Yet Assessable" and are not included in the analysis.

16. Professionalism - PROF2. Trustworthiness that makes colleagues feel secure when one is responsible for the care of patients

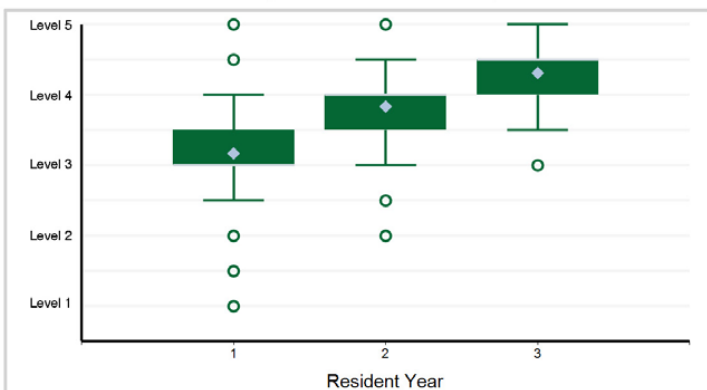

Note: 1 of 487 residents have a status of "Not Yet Assessable" and are not included in the analysis.

17. Professionalism - PROF3. Provide leadership skills that enhance team functioning, the learning environment, ...

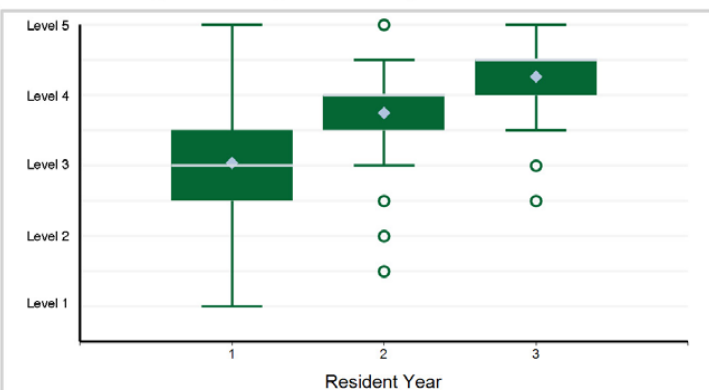

Note: 1 of 487 residents have a status of "Not Yet Assessable" and are not included in the analysis.

18. Professionalism - PROF4. The capacity to accept that ambiguity is part of clinical medicine and to recognize ...

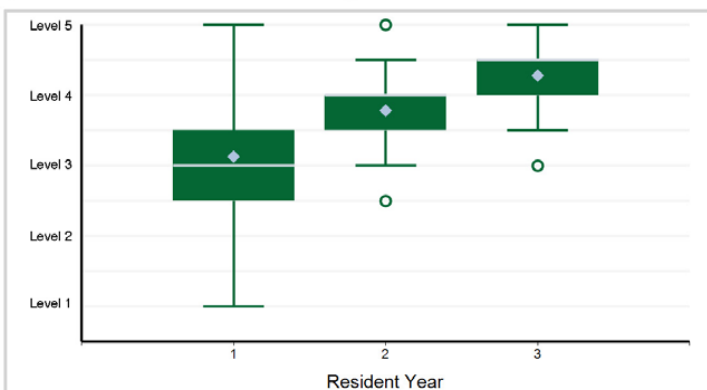

Note: 3 of 487 residents have a status of "Not Yet Assessable" and are not included in the analysis.

Specialty Box Plot Report - Milestone Evaluation by Resident Year: Year-End 2021-2022

SUBSPECIALTY: Pediatric Hematology Oncology

19. Interpersonal and Communication Skills - ICS1. Communicate effectively with physicians, other health professionals, and ...

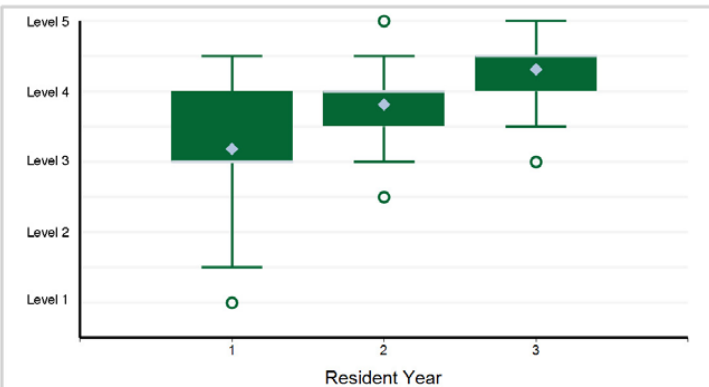

Note: 1 of 487 residents have a status of "Not Yet Assessable" and are not included in the analysis.

20. Interpersonal and Communication Skills - ICS2. Work effectively as a member or leader of a health care ...

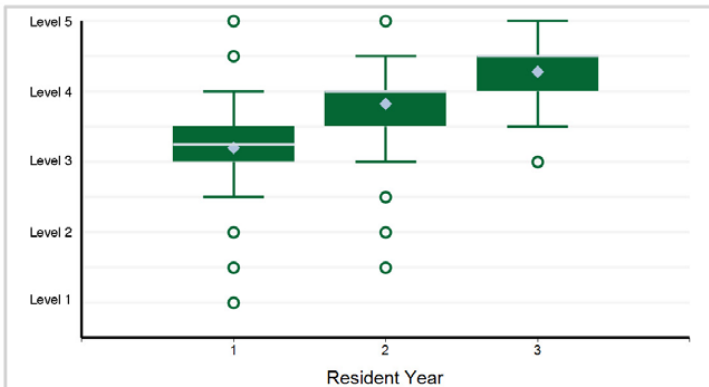

Note: 1 of 487 residents have a status of "Not Yet Assessable" and are not included in the analysis.

21. Interpersonal and Communication Skills - ICS3. Act in a consultative role to other physicians and health professionals

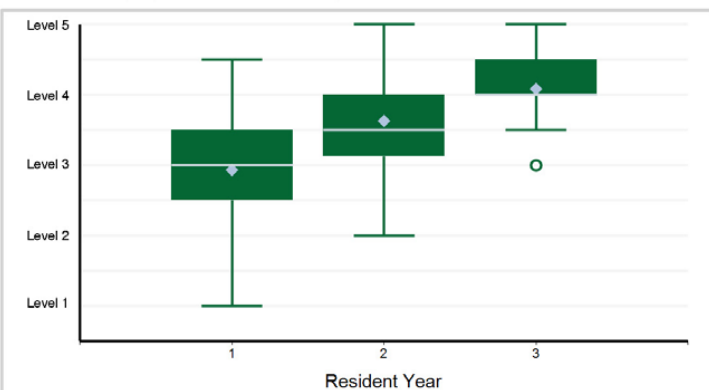

Note: 1 of 487 residents have a status of "Not Yet Assessable" and are not included in the analysis.

Specialty Box Plot Report - Milestone Evaluation by Resident Year: Year-End 2021-2022

TABLE 105: SUBSPECIALTY: **Pediatric Hospital Medicine**

Resident Year	1	2	Total Residents
# of Residents	92	73	165

1. Patient Care - PC1. Provide transfer of care that ensures seamless transitions

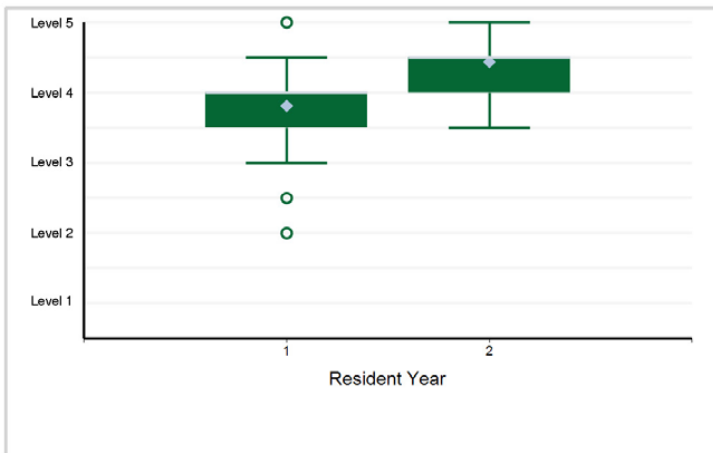

2. Patient Care - PC2. Make informed diagnostic and therapeutic decisions that result in optimal clinical judgment

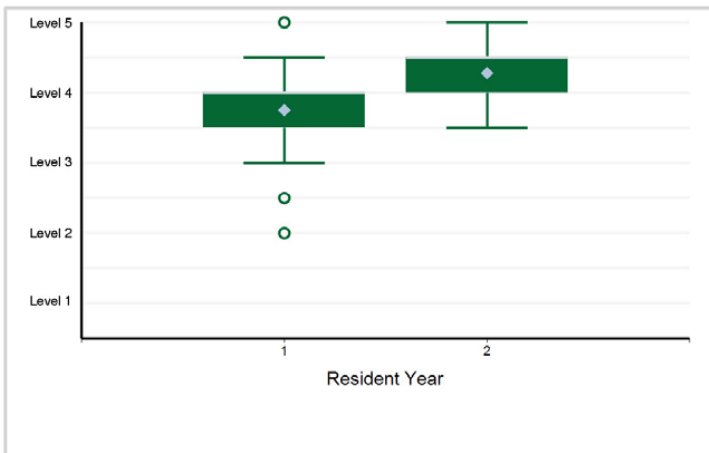

3. Patient Care - PC3. Develop and carry out management plans

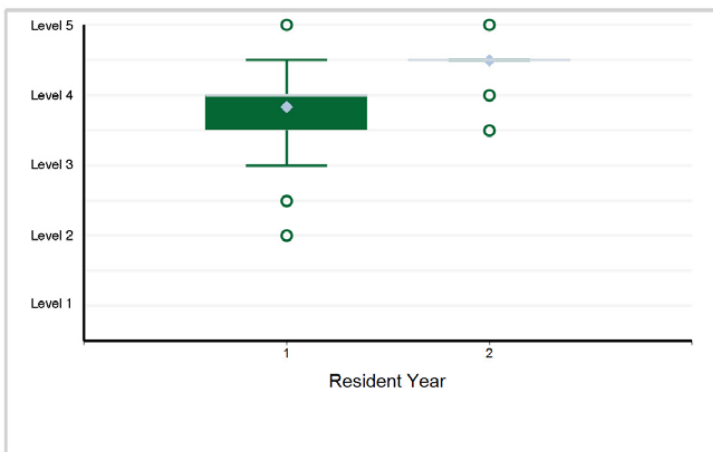

4. Patient Care - PC4. Provide appropriate role modeling

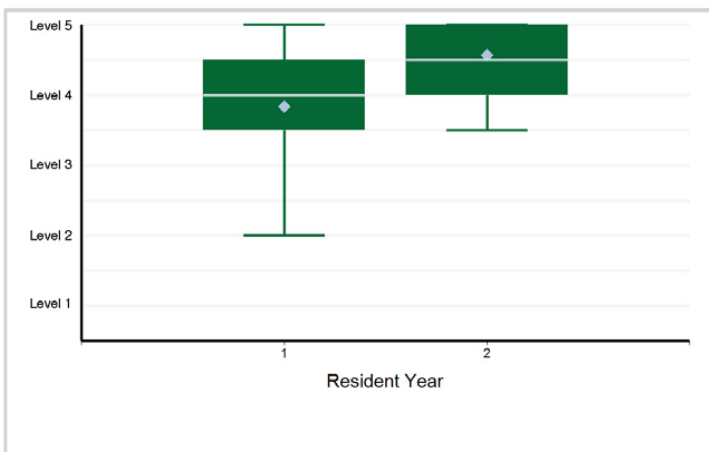

5. Medical Knowledge - MK1. Locate, appraise, and assimilate evidence from scientific studies related to ...

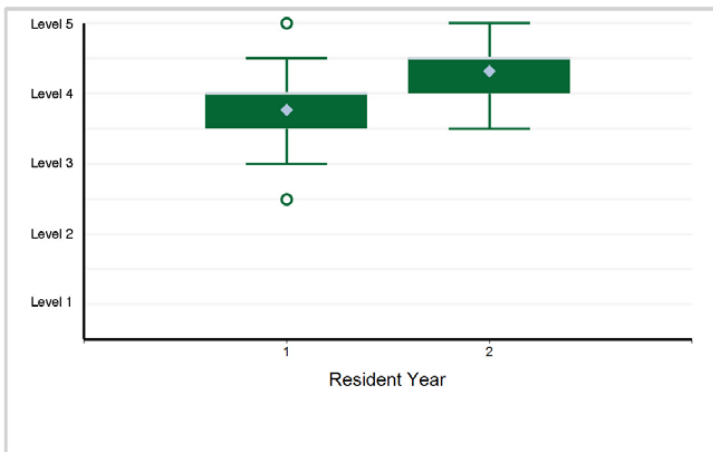

6. Systems-Based Practice - SBP1. Work effectively in various health care delivery settings and systems ...

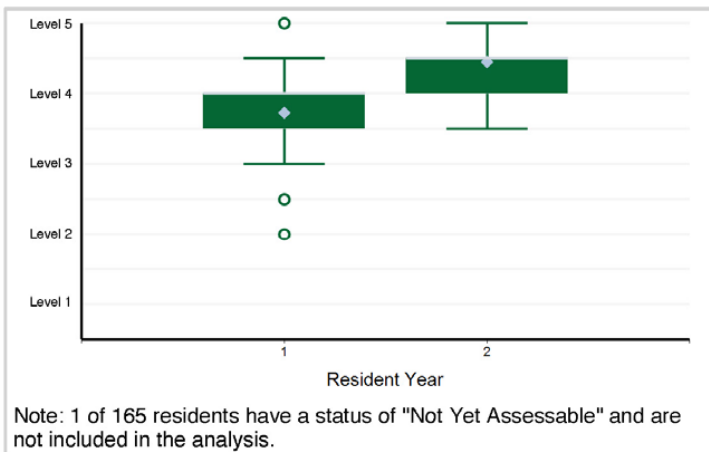

Note: 1 of 165 residents have a status of "Not Yet Assessable" and are not included in the analysis.

Specialty Box Plot Report - Milestone Evaluation by Resident Year: Year-End 2021-2022

SUBSPECIALTY: Pediatric Hospital Medicine

7. Systems-Based Practice - SBP2. Coordinate patient care within the health care system relevant to their clinical specialty

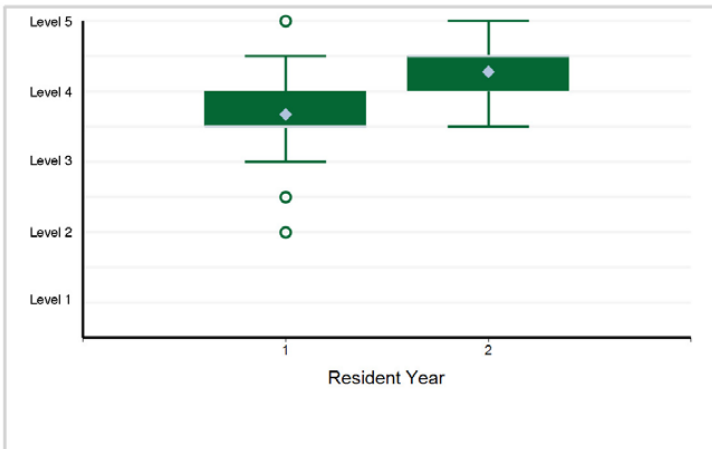

8. Systems-Based Practice - SBP3. Incorporate considerations of cost awareness and risk-benefit analysis in patient and/or ...

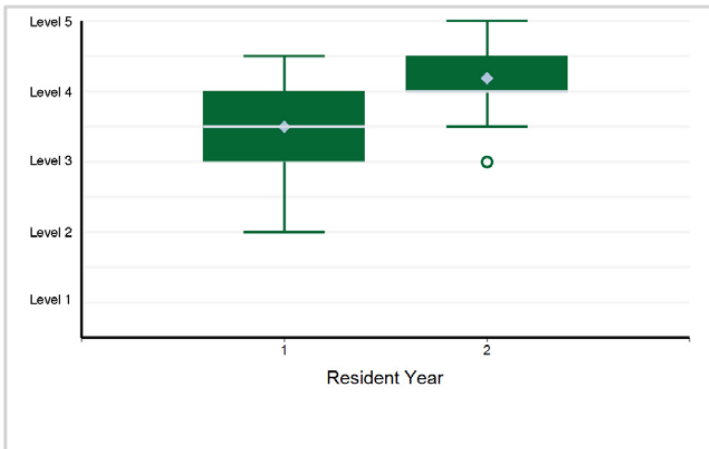

9. Systems-Based Practice - SBP4. Work in interprofessional teams to enhance patient safety and improve patient care quality

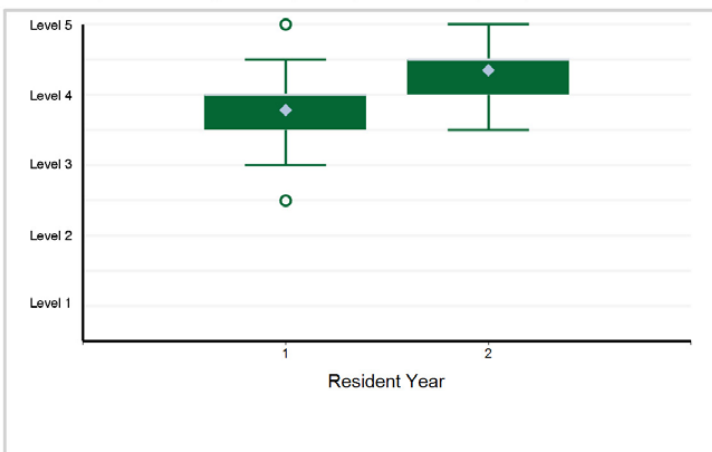

10. Systems-Based Practice - SBP5. Participate in identifying system errors and implementing potential systems solutions

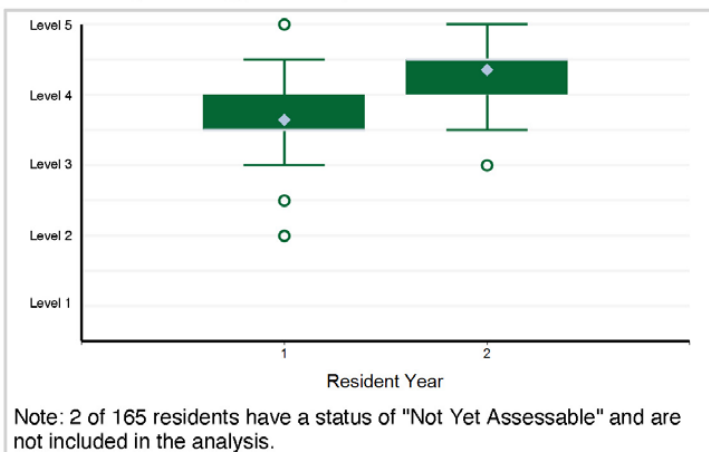

Note: 2 of 165 residents have a status of "Not Yet Assessable" and are not included in the analysis.

11. Practice-Based Learning and Improvement - PBLI1. Identify strengths, deficiencies, and limits in one's knowledge and expertise

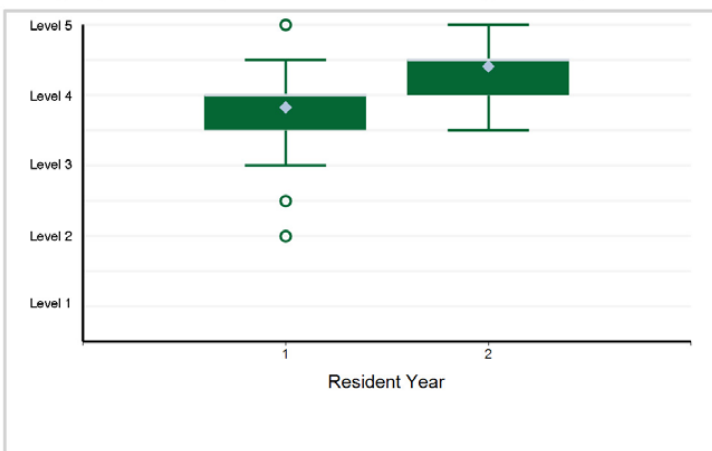

12. Practice-Based Learning and Improvement - PBLI2. Systematically analyze practice using quality improvement methods, and ...

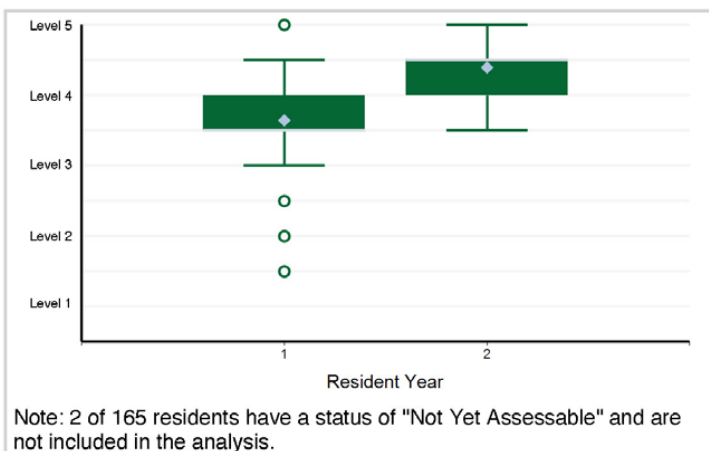

Note: 2 of 165 residents have a status of "Not Yet Assessable" and are not included in the analysis.

Specialty Box Plot Report - Milestone Evaluation by Resident Year: Year-End 2021-2022

SUBSPECIALTY: Pediatric Hospital Medicine

13. Practice-Based Learning and Improvement - PBLI3. Use information technology to optimize learning and care delivery

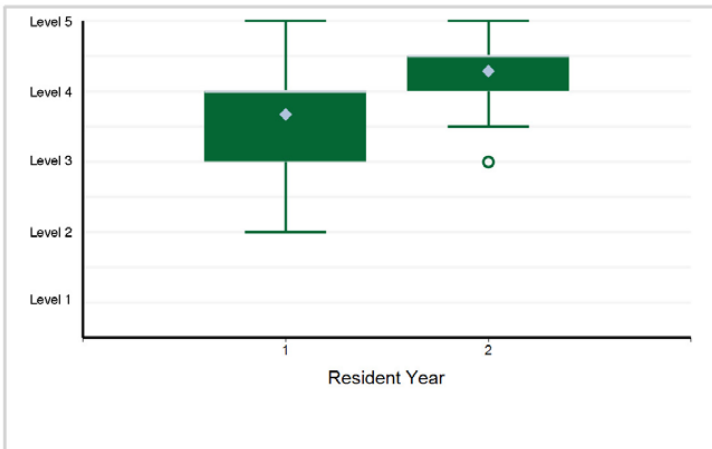

14. Practice-Based Learning and Improvement - PBLI4. Participate in the education of patients, families, ...

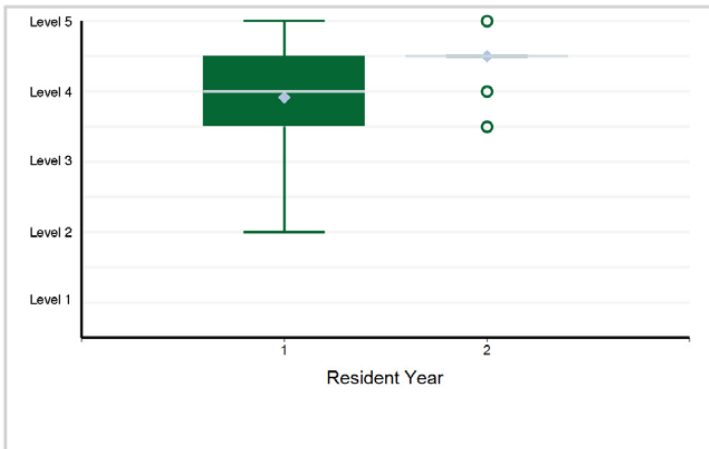

15. Professionalism - PROF1. Professional Conduct: High standards of ethical behavior which includes maintaining ...

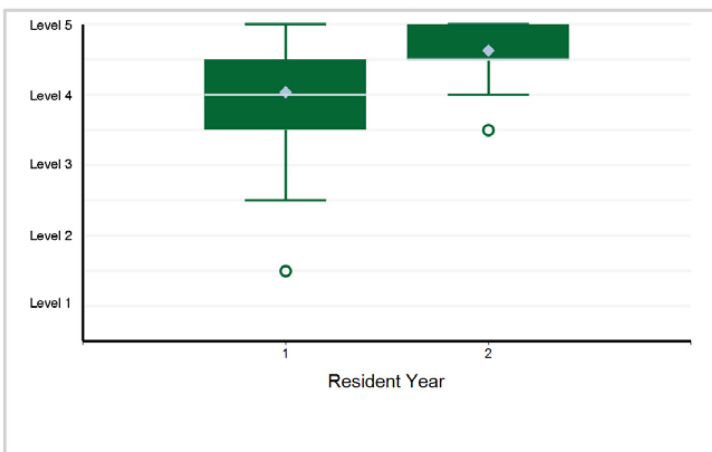

16. Professionalism - PROF2. Trustworthiness that makes colleagues feel secure when one is responsible for the care of patients

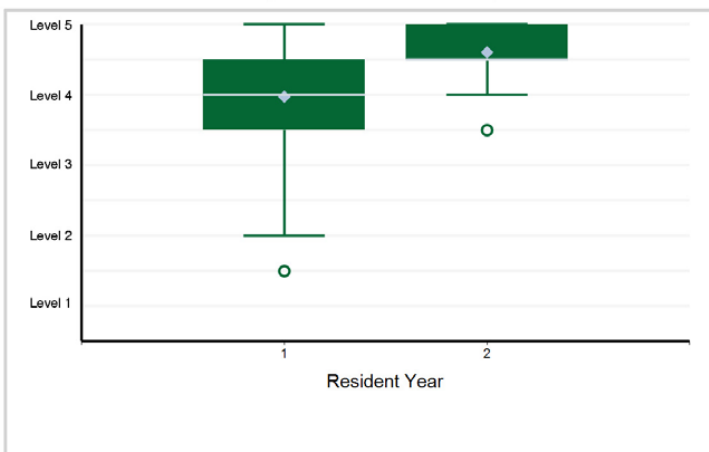

17. Professionalism - PROF3. Provide leadership skills that enhance team functioning, the learning environment, ...

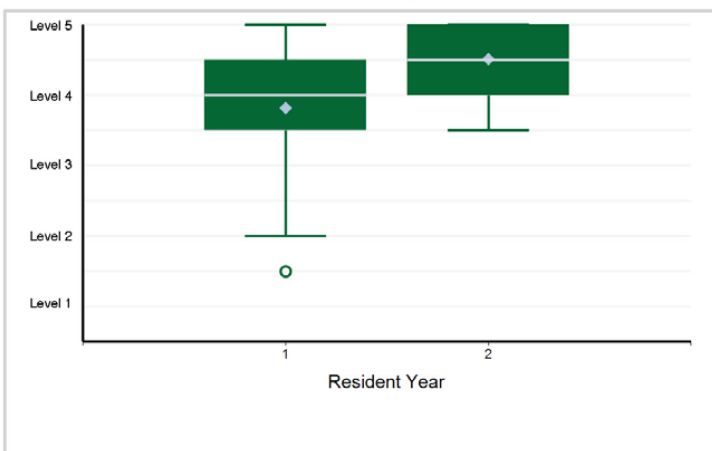

18. Professionalism - PROF4. The capacity to accept that ambiguity is part of clinical medicine and to recognize ...

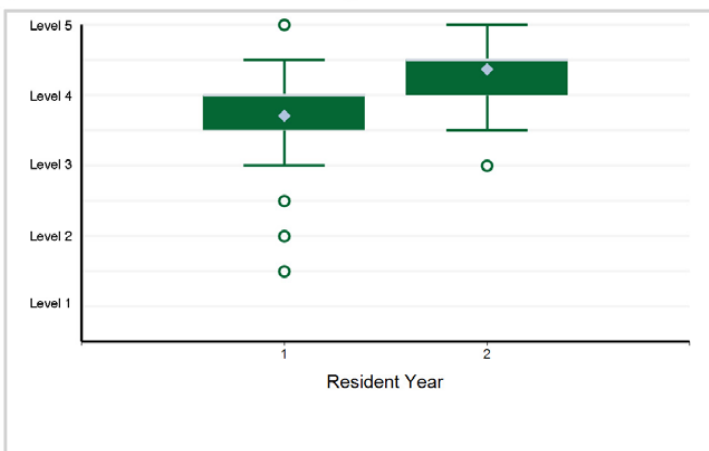

Specialty Box Plot Report - Milestone Evaluation by Resident Year: Year-End 2021-2022

SUBSPECIALTY: Pediatric Hospital Medicine

19. Interpersonal and Communication Skills - ICS1. Communicate effectively with physicians, other health professionals, and ...

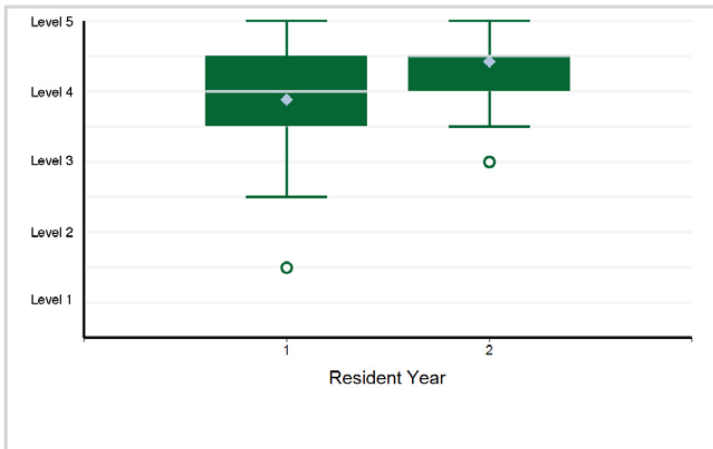

20. Interpersonal and Communication Skills - ICS2. Work effectively as a member or leader of a health care ...

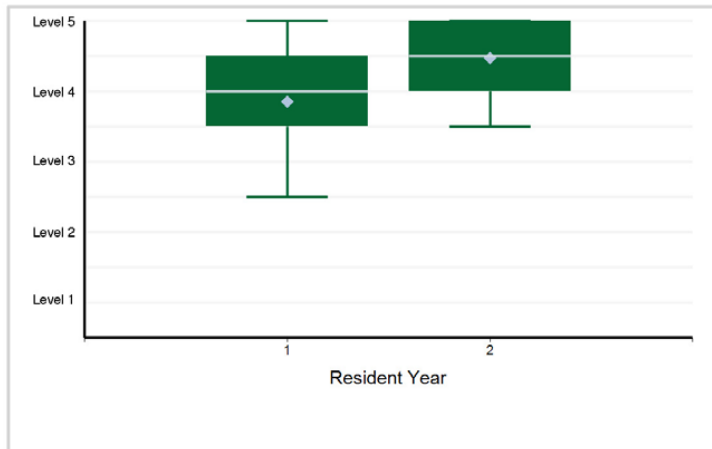

21. Interpersonal and Communication Skills - ICS3. Act in a consultative role to other physicians and health professionals

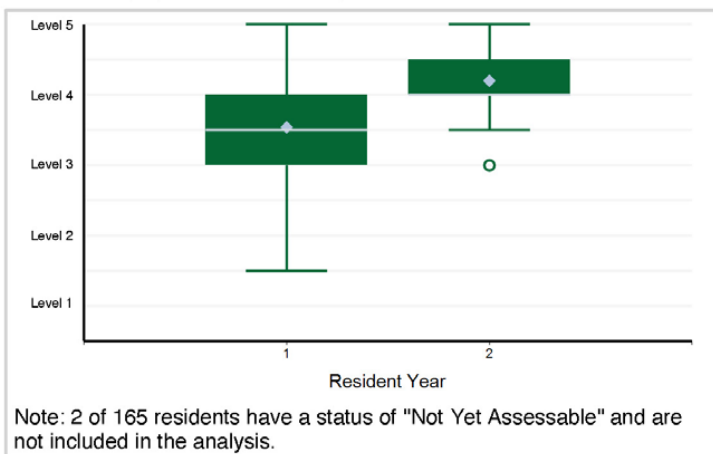

Specialty Box Plot Report - Milestone Evaluation by Resident Year: Year-End 2021-2022

TABLE 106: SUBSPECIALTY: **Pediatric Infectious Diseases**

Resident Year	1	2	3	Total Residents
# of Residents	60	68	56	184

1. Patient Care - PC1. Provide transfer of care that ensures seamless transitions

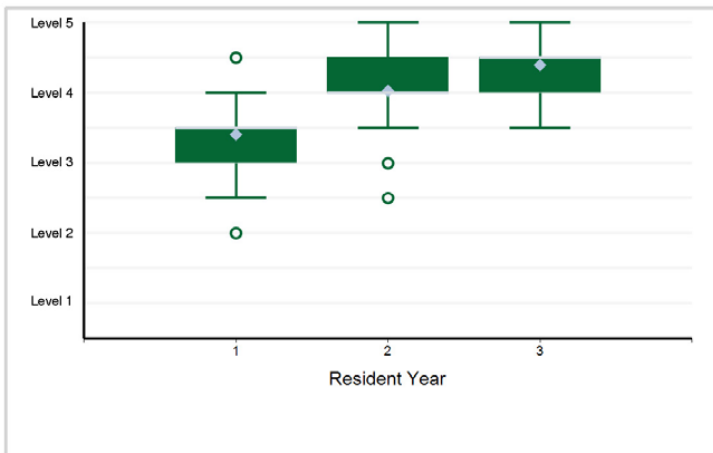

2. Patient Care - PC2. Make informed diagnostic and therapeutic decisions that result in optimal clinical judgment

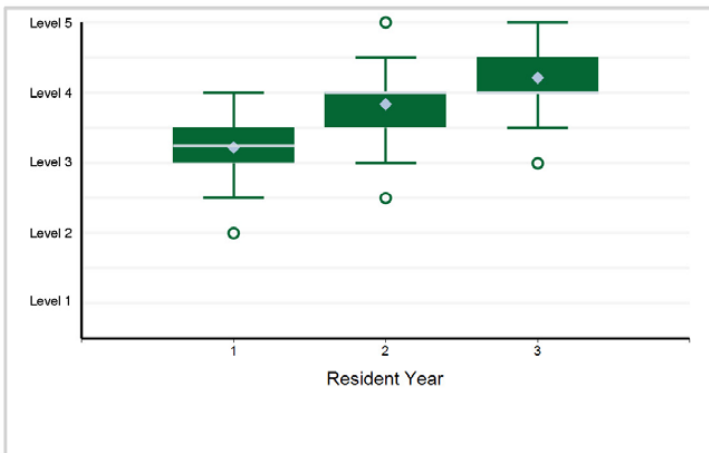

3. Patient Care - PC3. Develop and carry out management plans

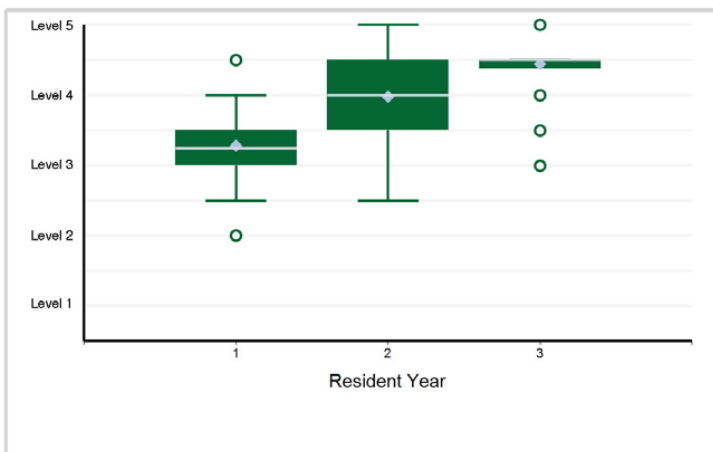

4. Patient Care - PC4. Provide appropriate role modeling

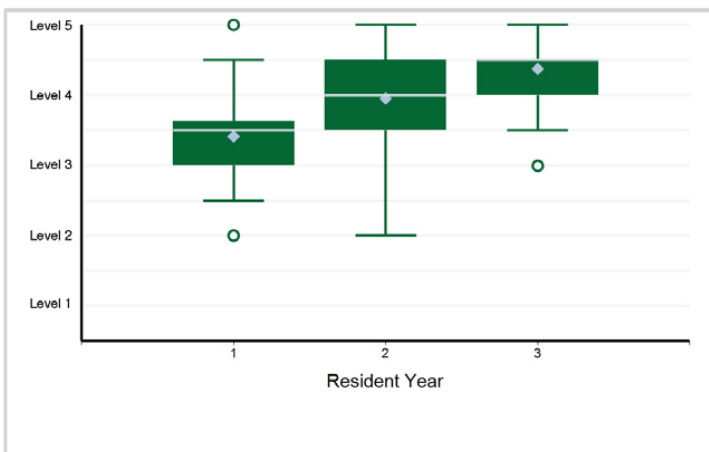

5. Medical Knowledge - MK1. Locate, appraise, and assimilate evidence from scientific studies related to ...

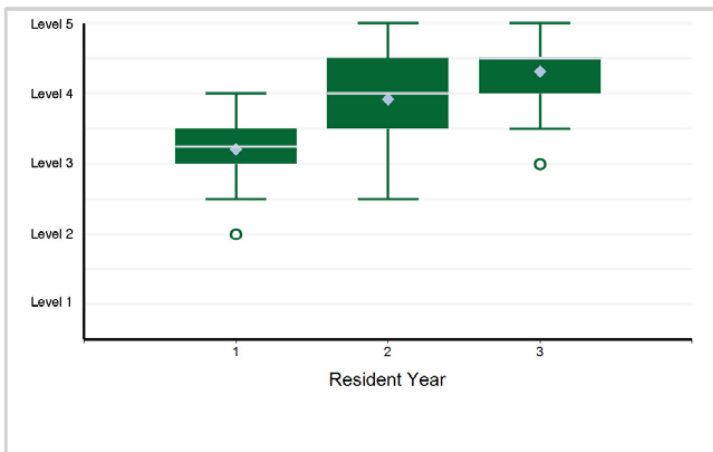

6. Systems-Based Practice - SBP1. Work effectively in various health care delivery settings and systems ...

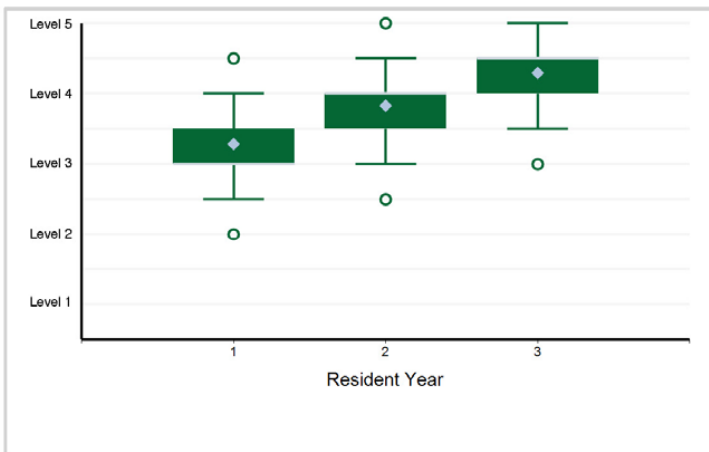

Specialty Box Plot Report - Milestone Evaluation by Resident Year: Year-End 2021-2022

SUBSPECIALTY: Pediatric Infectious Diseases

7. Systems-Based Practice - SBP2. Coordinate patient care within the health care system relevant to their clinical specialty

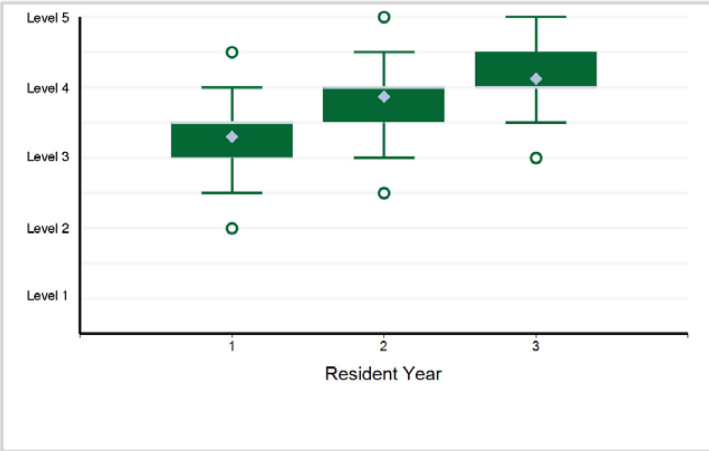

8. Systems-Based Practice - SBP3. Incorporate considerations of cost awareness and risk-benefit analysis in patient and/or ...

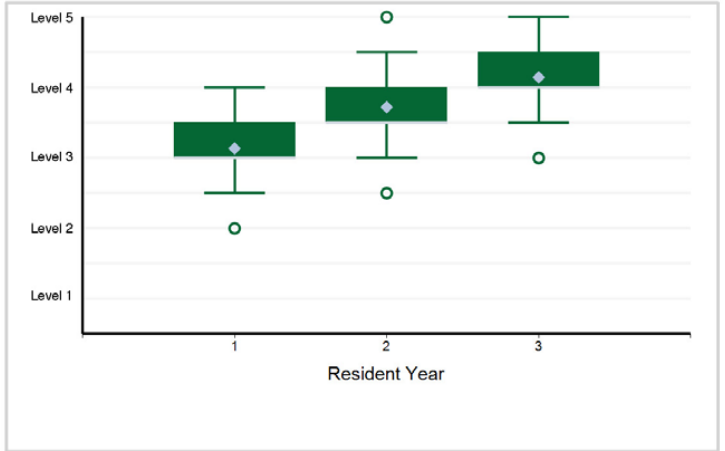

9. Systems-Based Practice - SBP4. Work in interprofessional teams to enhance patient safety and improve patient care quality

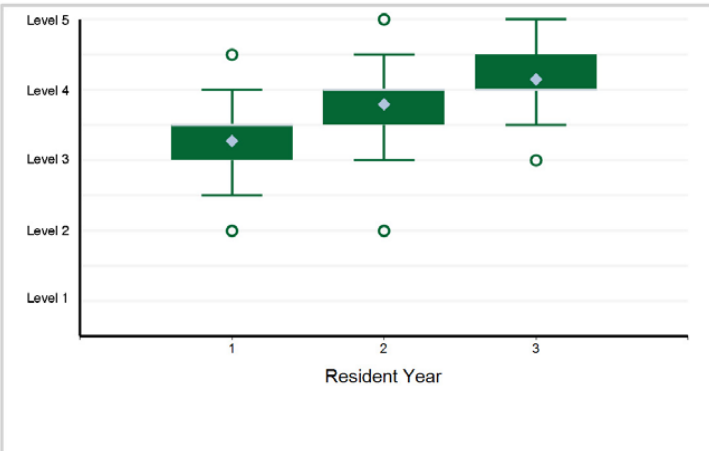

10. Systems-Based Practice - SBP5. Participate in identifying system errors and implementing potential systems solutions

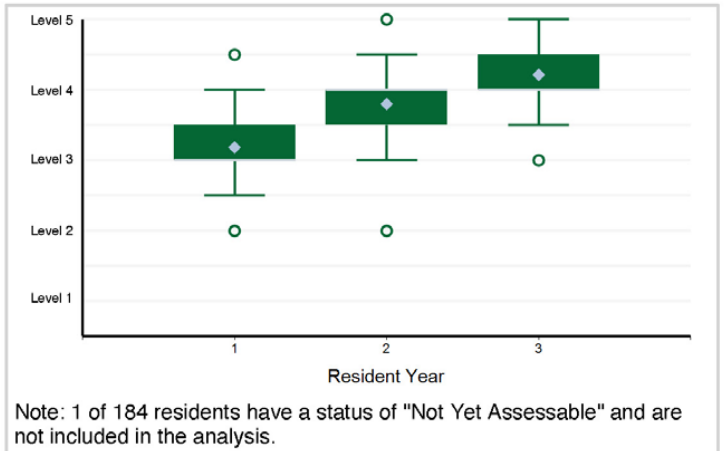

Note: 1 of 184 residents have a status of "Not Yet Assessable" and are not included in the analysis.

11. Practice-Based Learning and Improvement - PBLI1. Identify strengths, deficiencies, and limits in one's knowledge and expertise

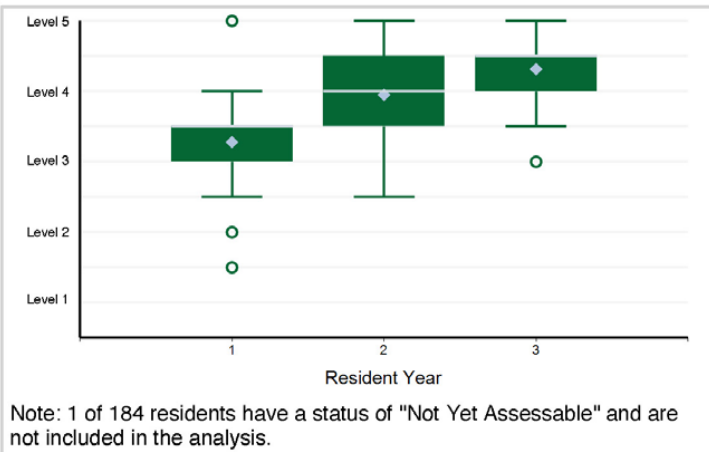

Note: 1 of 184 residents have a status of "Not Yet Assessable" and are not included in the analysis.

12. Practice-Based Learning and Improvement - PBLI2. Systematically analyze practice using quality improvement methods, and ...

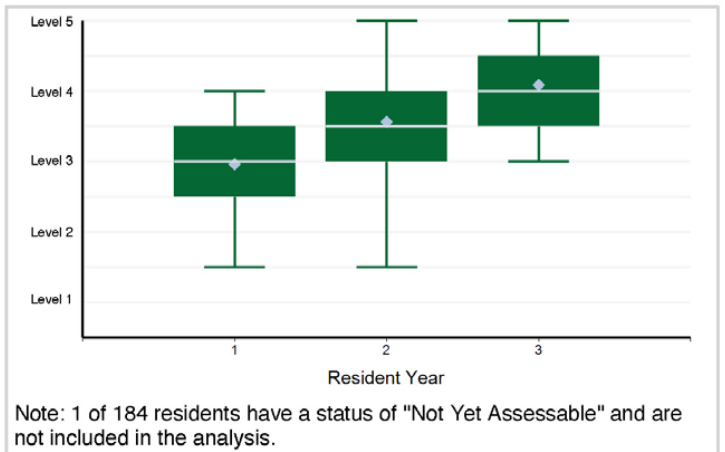

Note: 1 of 184 residents have a status of "Not Yet Assessable" and are not included in the analysis.

Specialty Box Plot Report - Milestone Evaluation by Resident Year: Year-End 2021-2022

SUBSPECIALTY: Pediatric Infectious Diseases

13. Practice-Based Learning and Improvement - PBLI3. Use information technology to optimize learning and care delivery

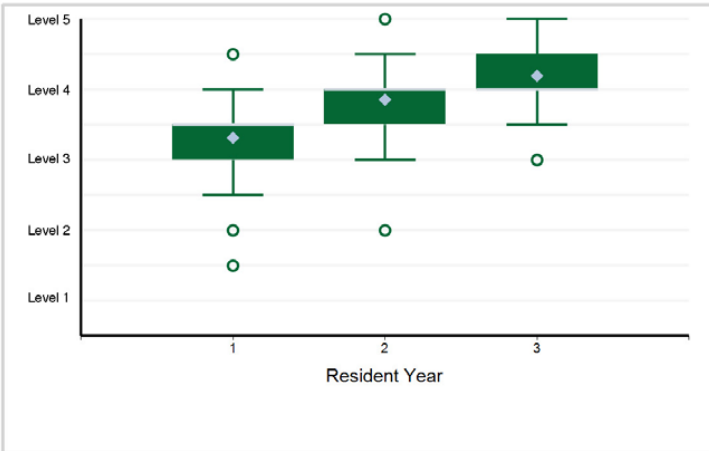

14. Practice-Based Learning and Improvement - PBLI4. Participate in the education of patients, families, ...

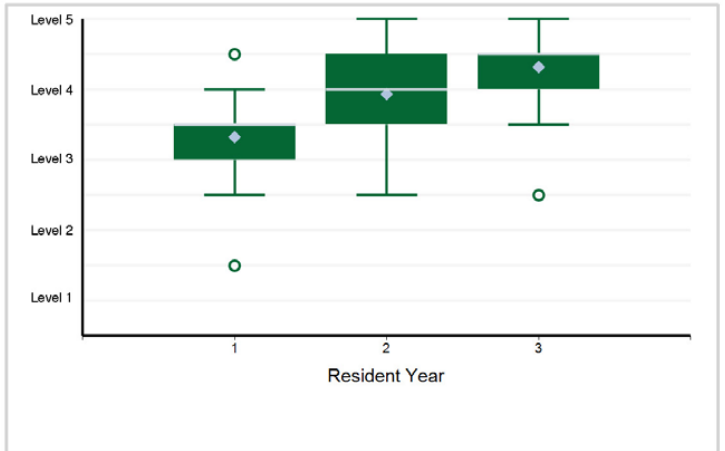

15. Professionalism - PROF1. Professional Conduct: High standards of ethical behavior which includes maintaining ...

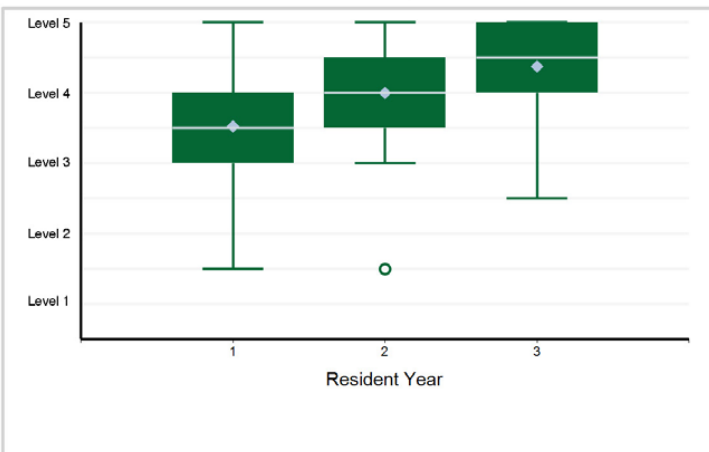

16. Professionalism - PROF2. Trustworthiness that makes colleagues feel secure when one is responsible for the care of patients

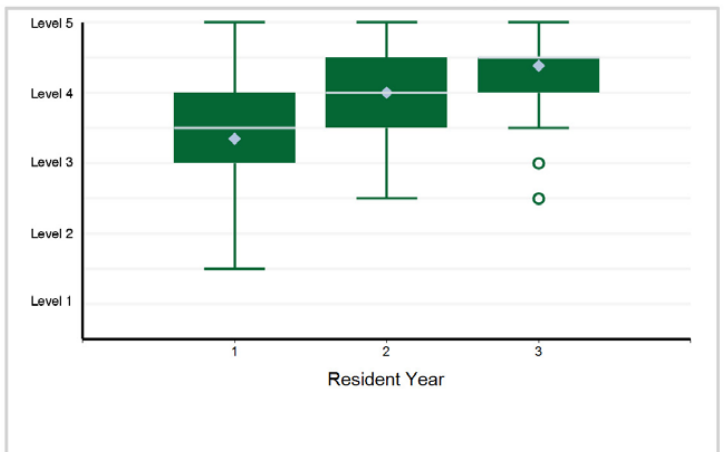

17. Professionalism - PROF3. Provide leadership skills that enhance team functioning, the learning environment, ...

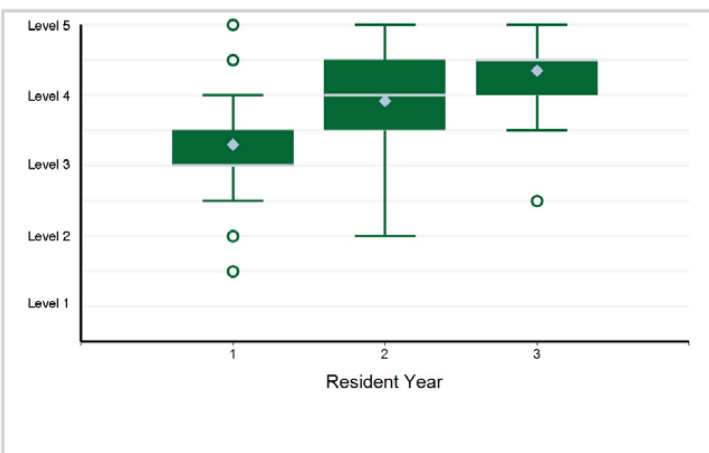

18. Professionalism - PROF4. The capacity to accept that ambiguity is part of clinical medicine and to recognize ...

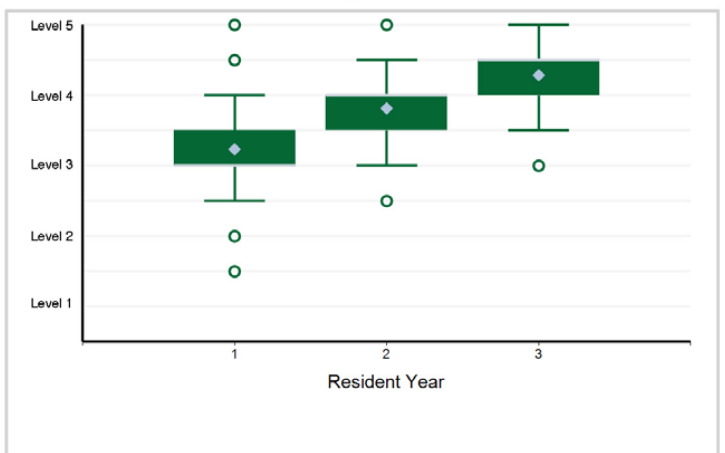

Specialty Box Plot Report - Milestone Evaluation by Resident Year: Year-End 2021-2022

SUBSPECIALTY: Pediatric Infectious Diseases

19. Interpersonal and Communication Skills - ICS1. Communicate effectively with physicians, other health professionals, and ...

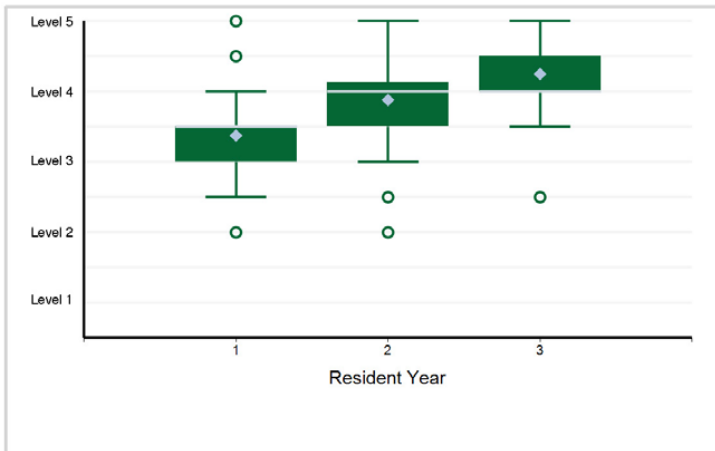

20. Interpersonal and Communication Skills - ICS2. Work effectively as a member or leader of a health care ...

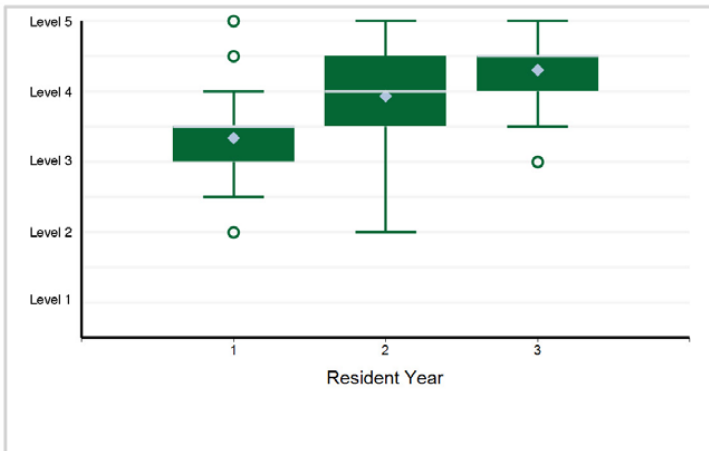

21. Interpersonal and Communication Skills - ICS3. Act in a consultative role to other physicians and health professionals

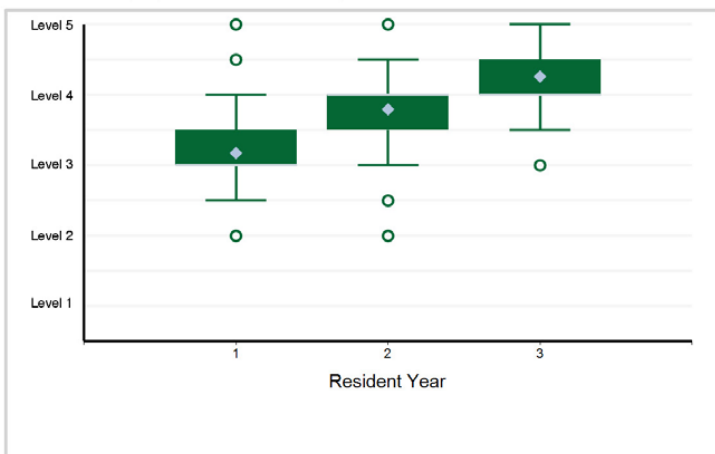

Specialty Box Plot Report - Milestone Evaluation by Resident Year: Year-End 2021-2022

TABLE 107: SUBSPECIALTY: **Pediatric Nephrology**

Resident Year	1	2	3	Total Residents
# of Residents	62	42	30	134

1. Patient Care - PC1. Provide transfer of care that ensures seamless transitions

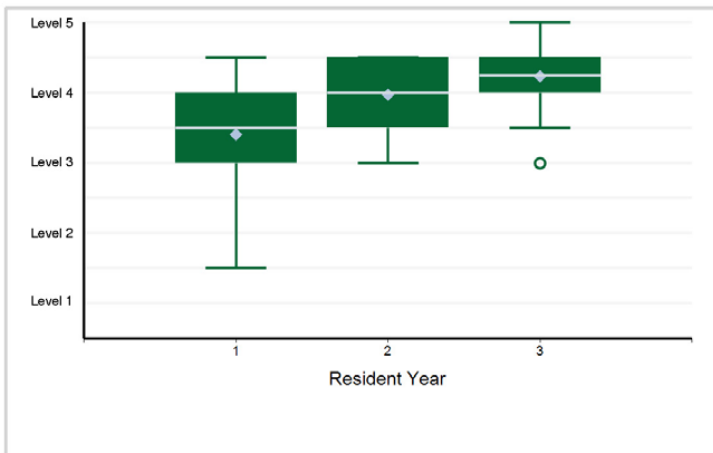

2. Patient Care - PC2. Make informed diagnostic and therapeutic decisions that result in optimal clinical judgment

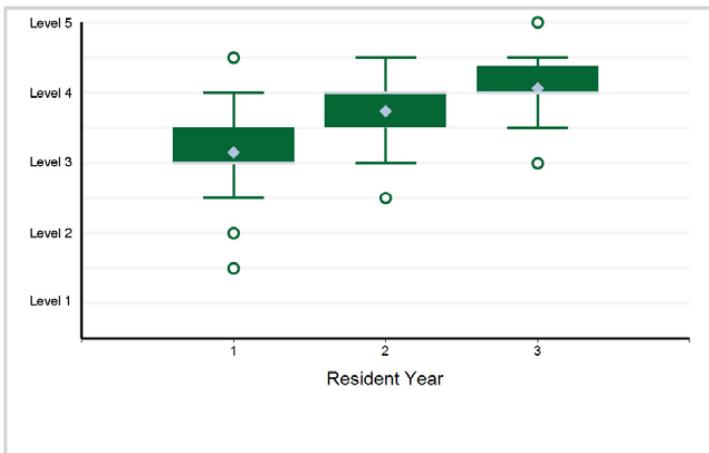

3. Patient Care - PC3. Develop and carry out management plans

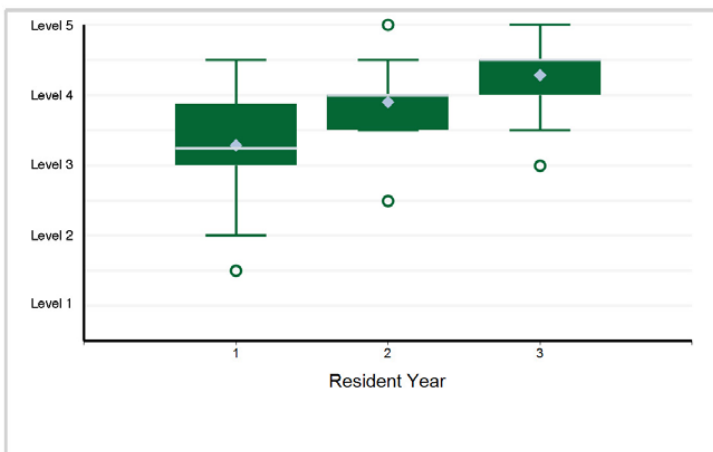

4. Patient Care - PC4. Provide appropriate role modeling

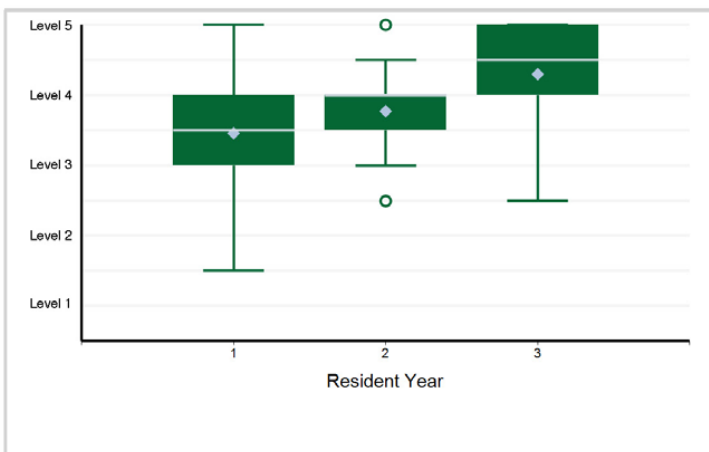

5. Medical Knowledge - MK1. Locate, appraise, and assimilate evidence from scientific studies related to ...

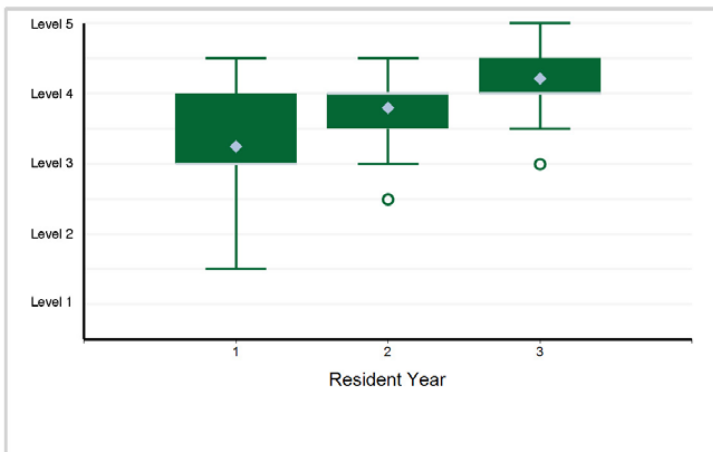

6. Systems-Based Practice - SBP1. Work effectively in various health care delivery settings and systems ...

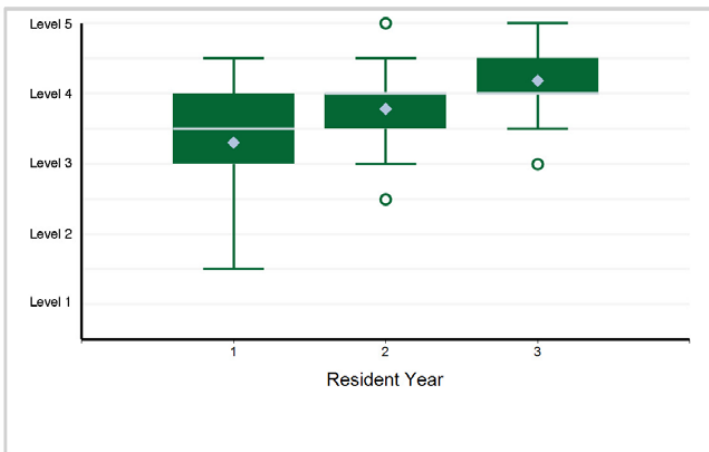

Specialty Box Plot Report - Milestone Evaluation by Resident Year: Year-End 2021-2022

SUBSPECIALTY: Pediatric Nephrology

7. Systems-Based Practice - SBP2. Coordinate patient care within the health care system relevant to their clinical specialty

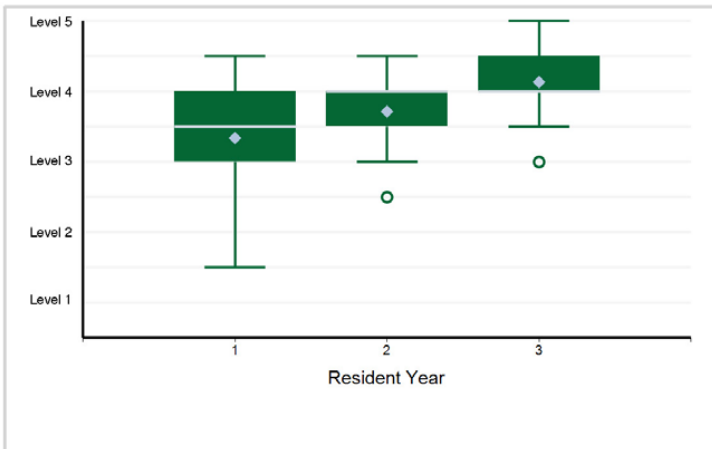

8. Systems-Based Practice - SBP3. Incorporate considerations of cost awareness and risk-benefit analysis in patient and/or ...

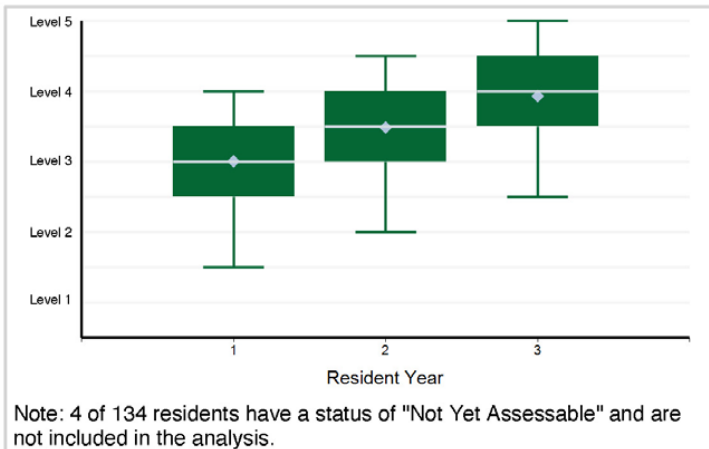

9. Systems-Based Practice - SBP4. Work in interprofessional teams to enhance patient safety and improve patient care quality

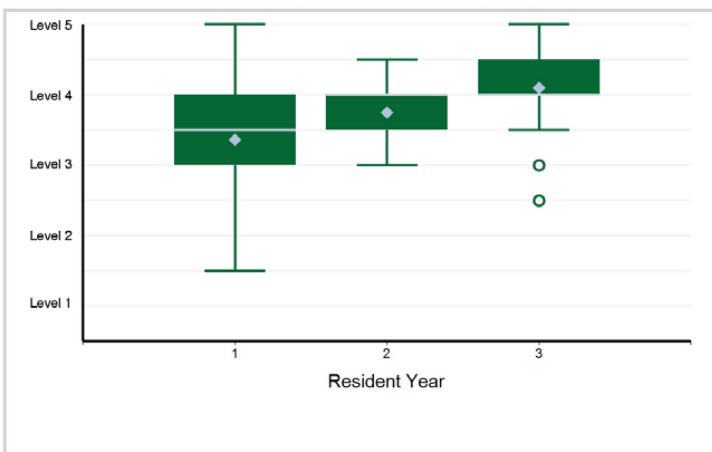

10. Systems-Based Practice - SBP5. Participate in identifying system errors and implementing potential systems solutions

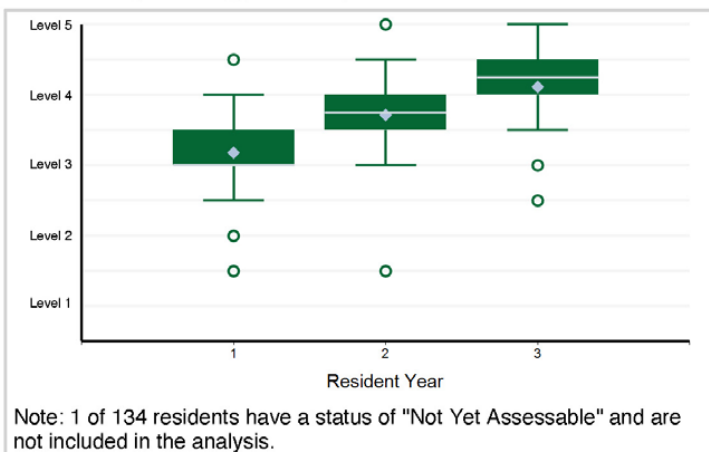

11. Practice-Based Learning and Improvement - PBLI1. Identify strengths, deficiencies, and limits in one's knowledge and expertise

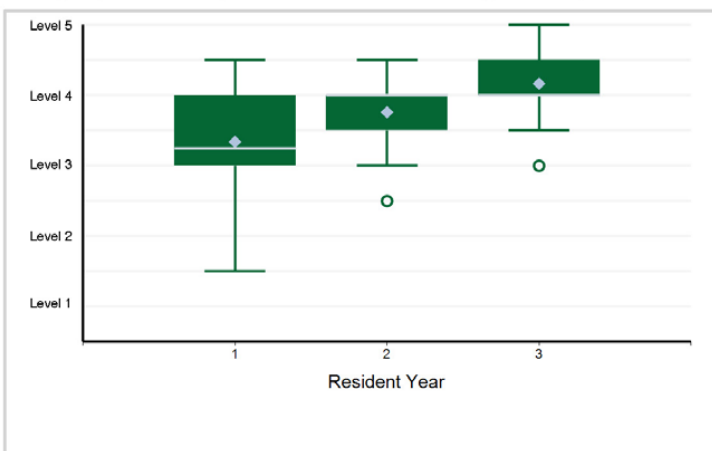

12. Practice-Based Learning and Improvement - PBLI2. Systematically analyze practice using quality improvement methods, and ...

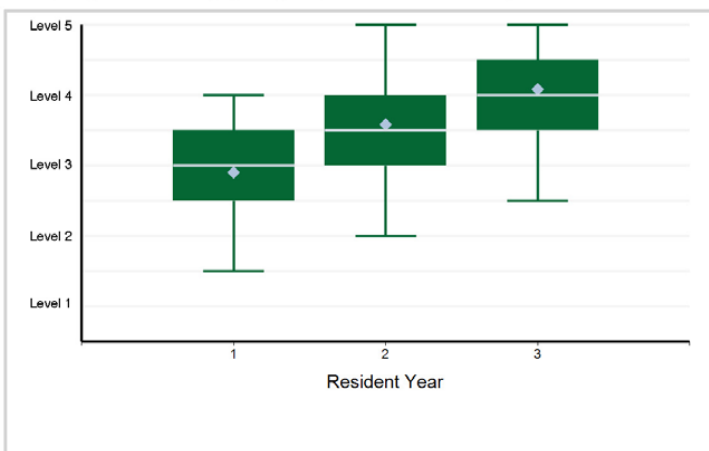

Specialty Box Plot Report - Milestone Evaluation by Resident Year: Year-End 2021-2022

SUBSPECIALTY: Pediatric Nephrology

13. Practice-Based Learning and Improvement - PBLI3. Use information technology to optimize learning and care delivery

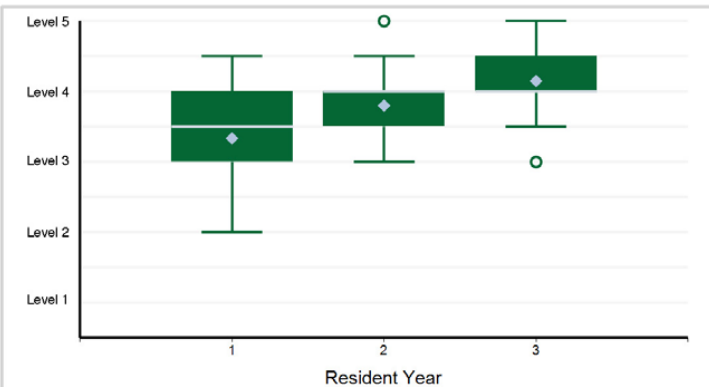

Note: 1 of 134 residents have a status of "Not Yet Assessable" and are not included in the analysis.

14. Practice-Based Learning and Improvement - PBLI4. Participate in the education of patients, families, ...

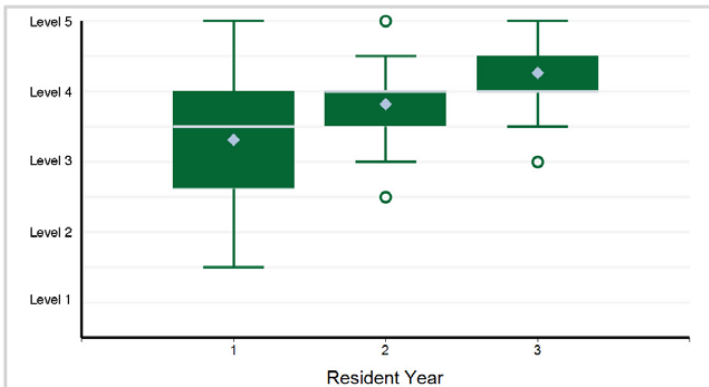

15. Professionalism - PROF1. Professional Conduct: High standards of ethical behavior which includes maintaining ...

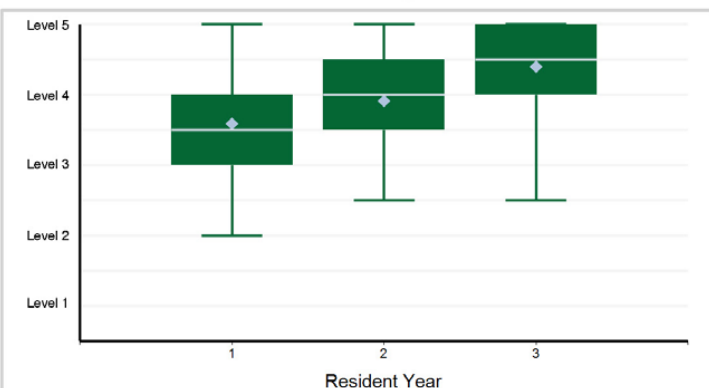

16. Professionalism - PROF2. Trustworthiness that makes colleagues feel secure when one is responsible for the care of patients

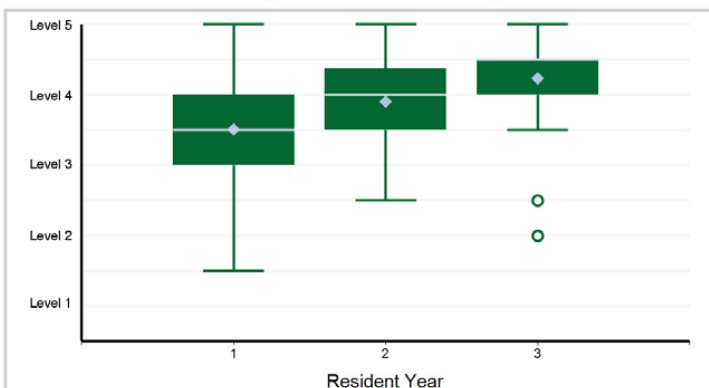

17. Professionalism - PROF3. Provide leadership skills that enhance team functioning, the learning environment, ...

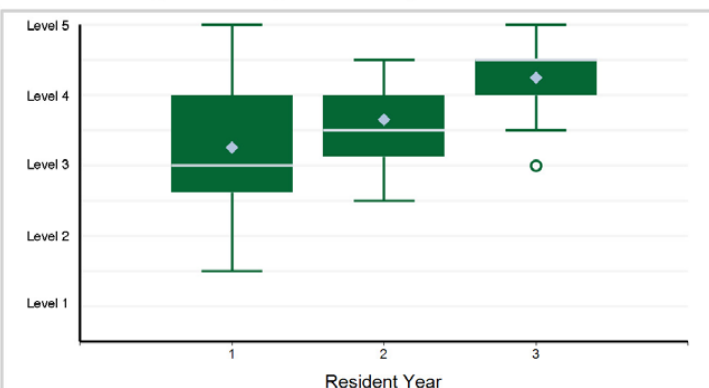

18. Professionalism - PROF4. The capacity to accept that ambiguity is part of clinical medicine and to recognize ...

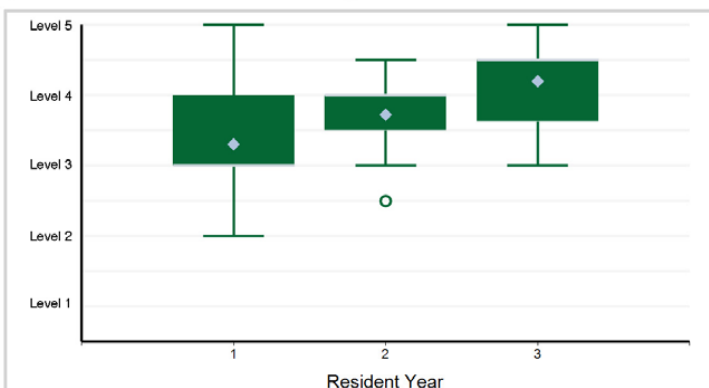

Specialty Box Plot Report - Milestone Evaluation by Resident Year: Year-End 2021-2022

SUBSPECIALTY: Pediatric Nephrology

19. Interpersonal and Communication Skills - ICS1. Communicate effectively with physicians, other health professionals, and ...

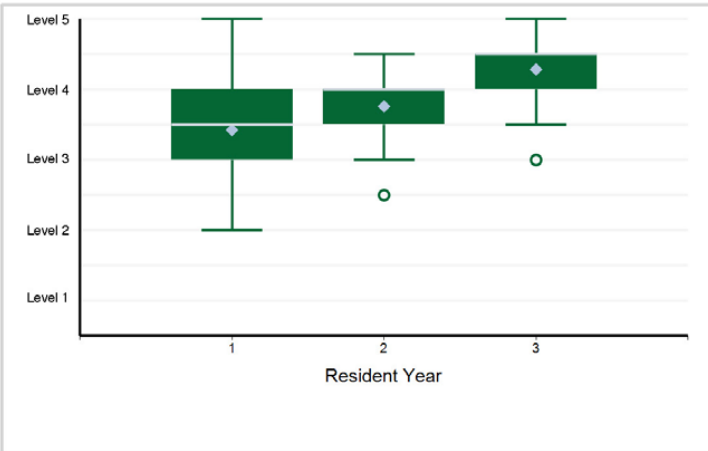

20. Interpersonal and Communication Skills - ICS2. Work effectively as a member or leader of a health care ...

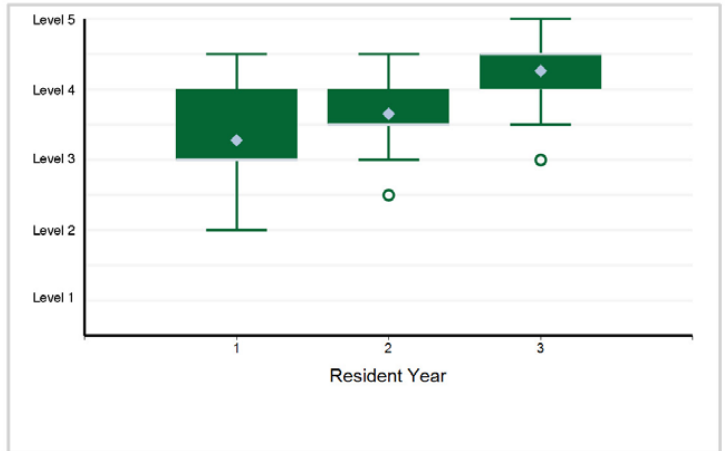

21. Interpersonal and Communication Skills - ICS3. Act in a consultative role to other physicians and health professionals

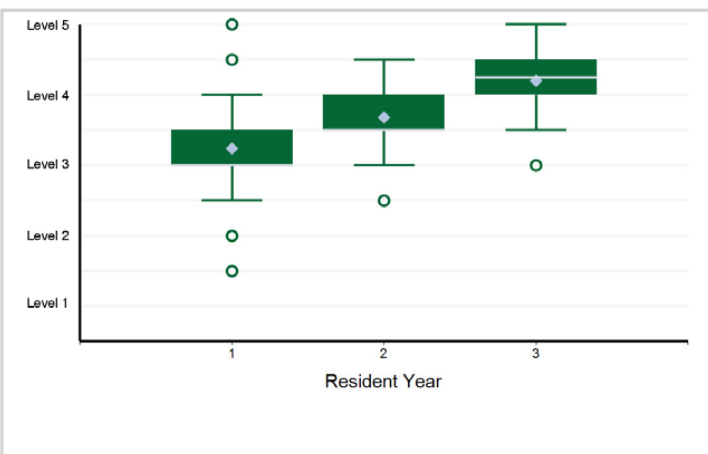

Specialty Box Plot Report - Milestone Evaluation by Resident Year: Year-End 2021-2022

TABLE 108: SUBSPECIALTY: **Pediatric Pulmonology**

Resident Year	1	2	3	Total Residents*
# of Residents	69	59	58	186

*Note: There are 9 residents with an incomplete milestone evaluation that are excluded from the box plots below.

1. Patient Care - PC1. Provide transfer of care that ensures seamless transitions

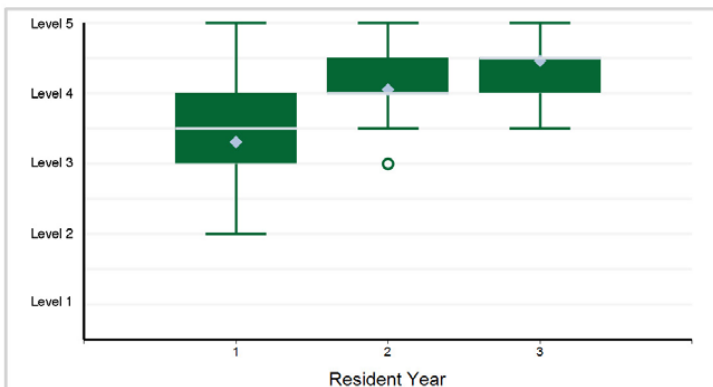

Note: 4 of 177 residents have a status of "Not Yet Assessable" and are not included in the analysis.

2. Patient Care - PC2. Make informed diagnostic and therapeutic decisions that result in optimal clinical judgment

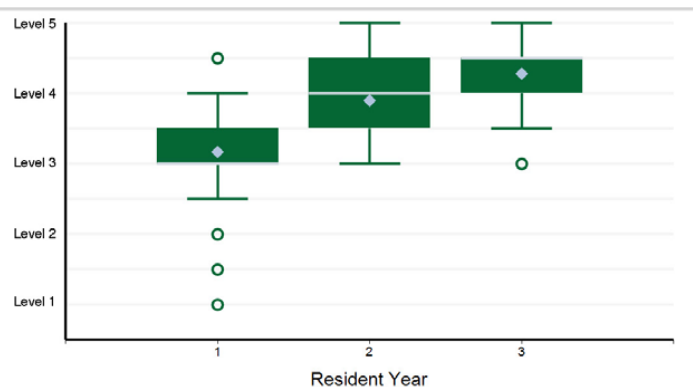

Note: 1 of 177 residents have a status of "Not Yet Assessable" and are not included in the analysis.

3. Patient Care - PC3. Develop and carry out management plans

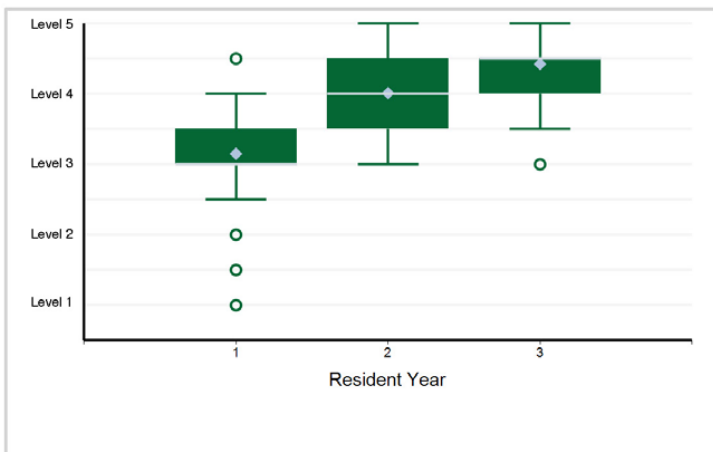

4. Patient Care - PC4. Provide appropriate role modeling

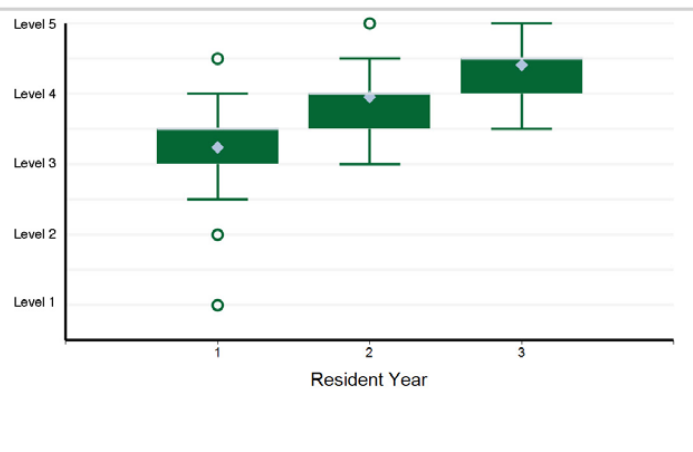

5. Medical Knowledge - MK1. Locate, appraise, and assimilate evidence from scientific studies related to ...

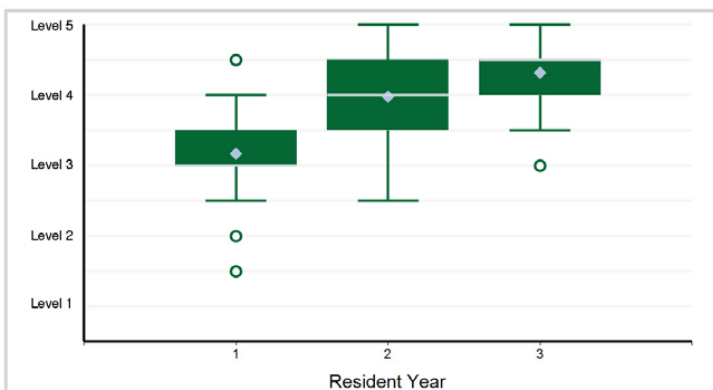

Note: 1 of 177 residents have a status of "Not Yet Assessable" and are not included in the analysis.

6. Systems-Based Practice - SBP1. Work effectively in various health care delivery settings and systems ...

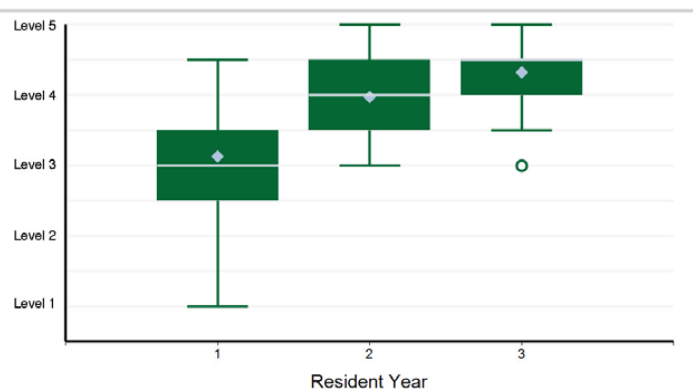

Specialty Box Plot Report - Milestone Evaluation by Resident Year: Year-End 2021-2022

SUBSPECIALTY: Pediatric Pulmonology

7. Systems-Based Practice - SBP2. Coordinate patient care within the health care system relevant to their clinical specialty

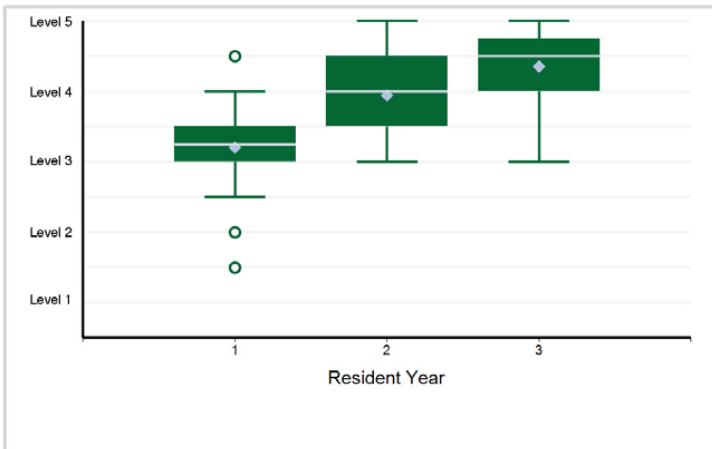

8. Systems-Based Practice - SBP3. Incorporate considerations of cost awareness and risk-benefit analysis in patient and/or ...

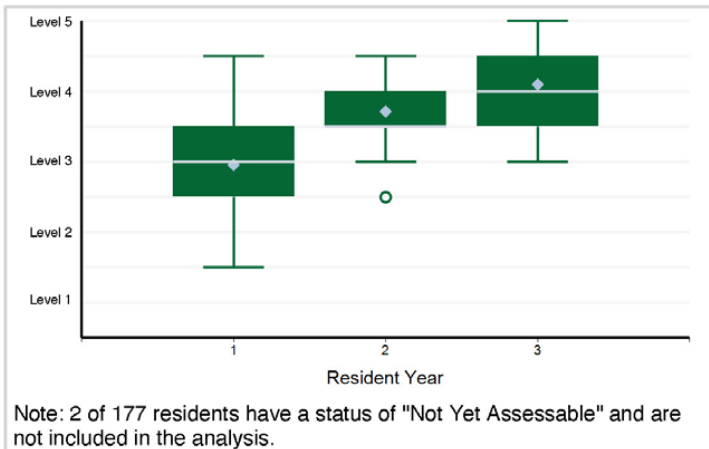

9. Systems-Based Practice - SBP4. Work in interprofessional teams to enhance patient safety and improve patient care quality

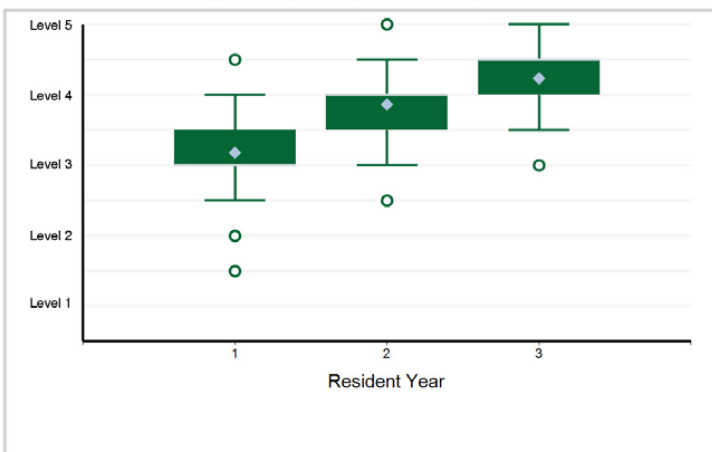

10. Systems-Based Practice - SBP5. Participate in identifying system errors and implementing potential systems solutions

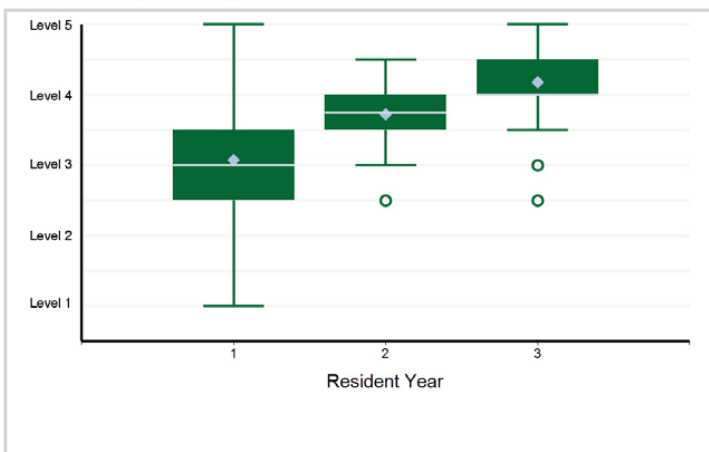

11. Practice-Based Learning and Improvement - PBLI1. Identify strengths, deficiencies, and limits in one's knowledge and expertise

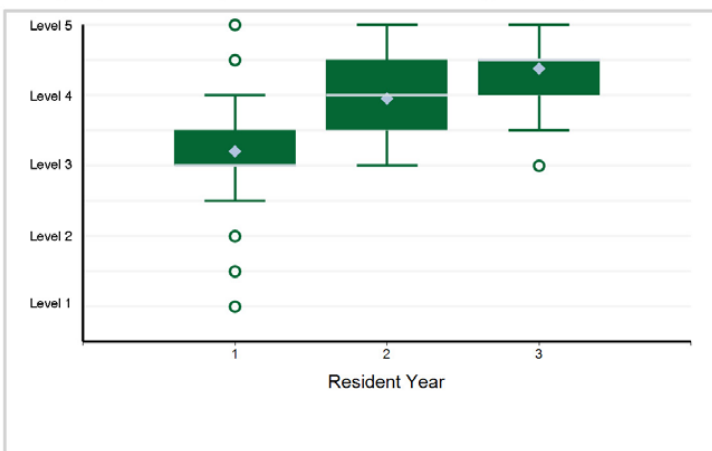

12. Practice-Based Learning and Improvement - PBLI2. Systematically analyze practice using quality improvement methods, and ...

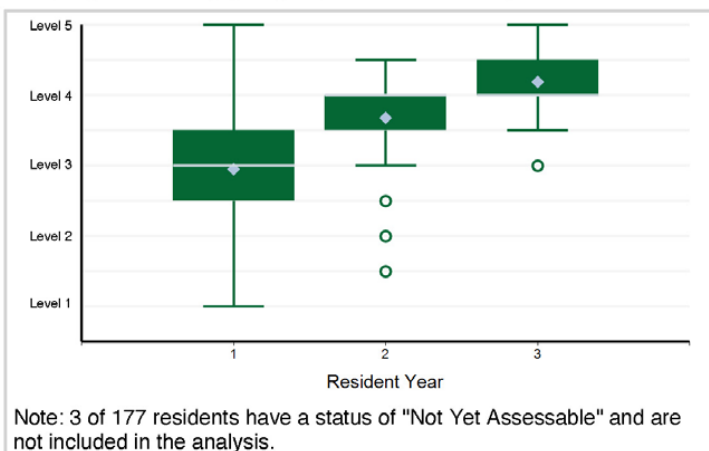

Specialty Box Plot Report - Milestone Evaluation by Resident Year: Year-End 2021-2022

SUBSPECIALTY: Pediatric Pulmonology

13. Practice-Based Learning and Improvement - PBLI3. Use information technology to optimize learning and care delivery

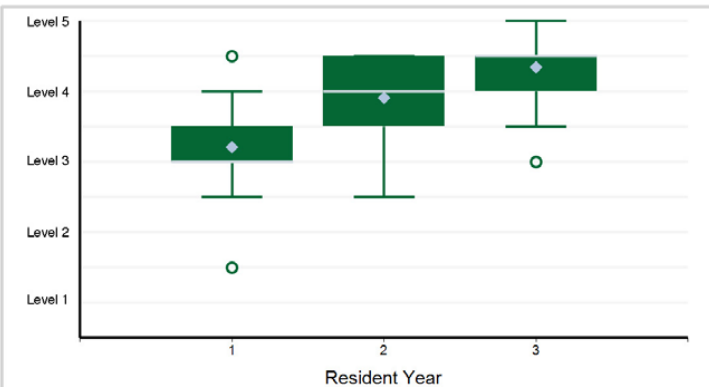

Note: 1 of 177 residents have a status of "Not Yet Assessable" and are not included in the analysis.

14. Practice-Based Learning and Improvement - PBLI4. Participate in the education of patients, families, ...

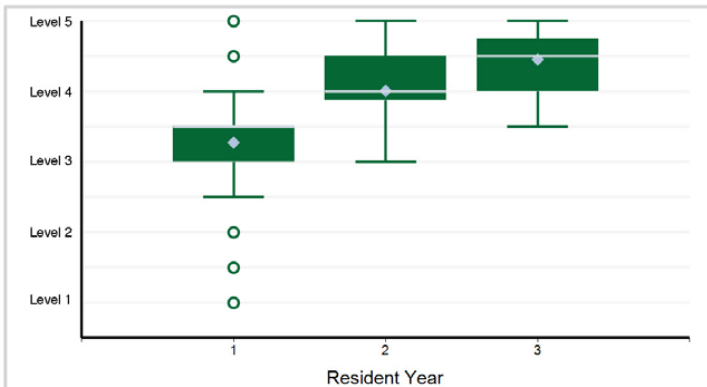

15. Professionalism - PROF1. Professional Conduct: High standards of ethical behavior which includes maintaining ...

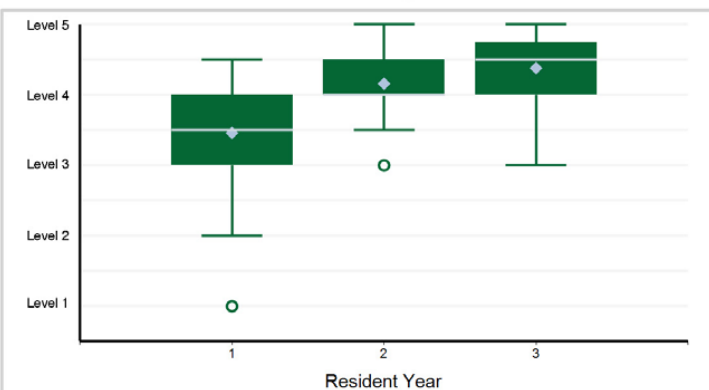

16. Professionalism - PROF2. Trustworthiness that makes colleagues feel secure when one is responsible for the care of patients

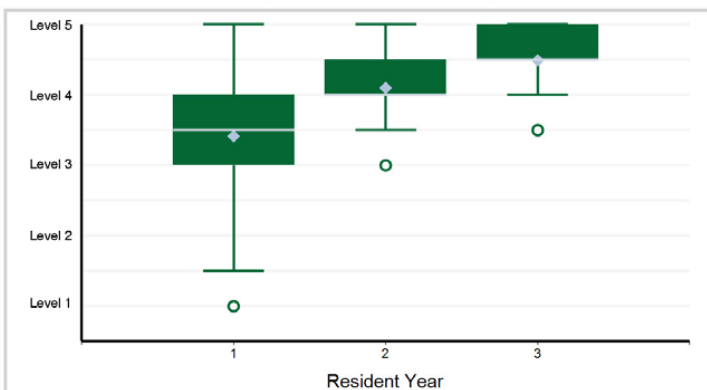

17. Professionalism - PROF3. Provide leadership skills that enhance team functioning, the learning environment, ...

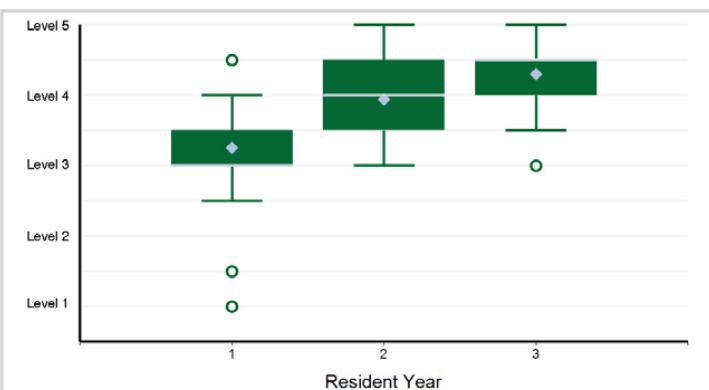

Note: 1 of 177 residents have a status of "Not Yet Assessable" and are not included in the analysis.

18. Professionalism - PROF4. The capacity to accept that ambiguity is part of clinical medicine and to recognize ...

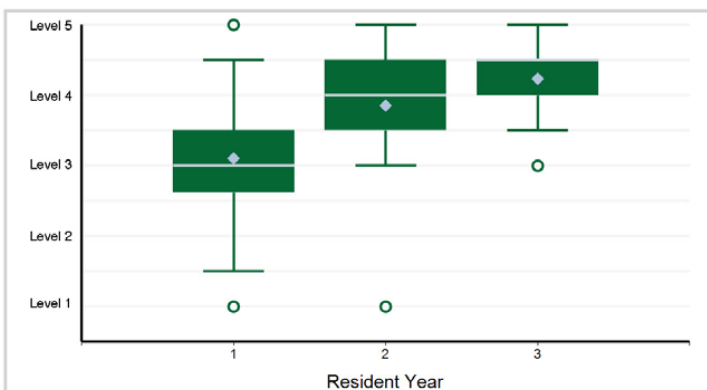

Specialty Box Plot Report - Milestone Evaluation by Resident Year: Year-End 2021-2022

SUBSPECIALTY: Pediatric Pulmonology

19. Interpersonal and Communication Skills - ICS1. Communicate effectively with physicians, other health professionals, and ...

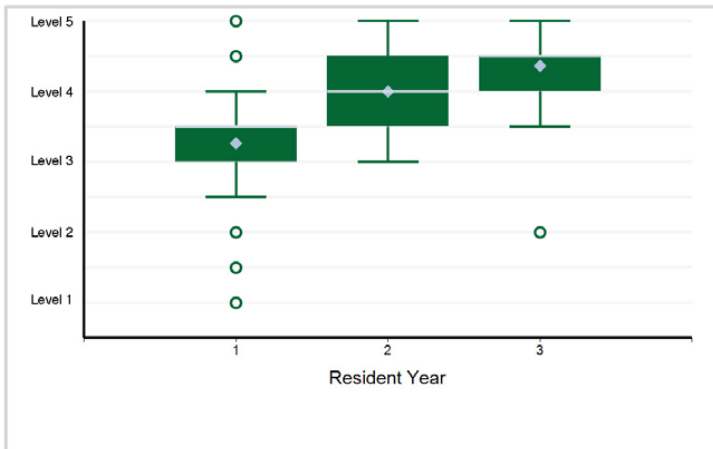

20. Interpersonal and Communication Skills - ICS2. Work effectively as a member or leader of a health care ...

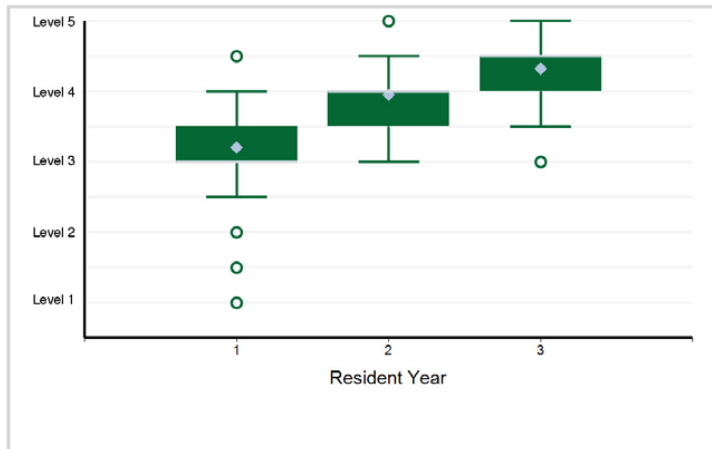

21. Interpersonal and Communication Skills - ICS3. Act in a consultative role to other physicians and health professionals

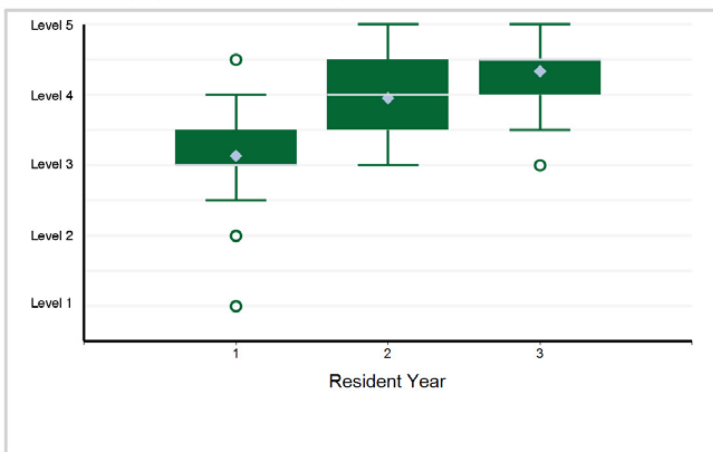

Specialty Box Plot Report - Milestone Evaluation by Resident Year: Year-End 2021-2022

TABLE 109: SUBSPECIALTY: **Pediatric Rheumatology**

Resident Year	1	2	3	Total Residents
# of Residents	41	36	26	103

1. Patient Care - PC1. Provide transfer of care that ensures seamless transitions

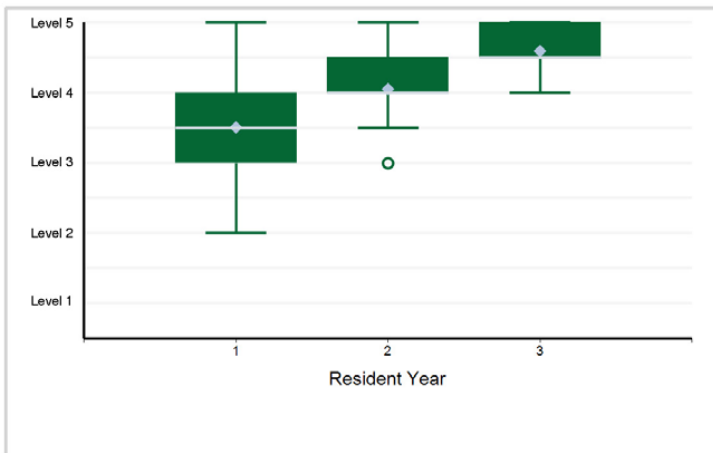

2. Patient Care - PC2. Make informed diagnostic and therapeutic decisions that result in optimal clinical judgment

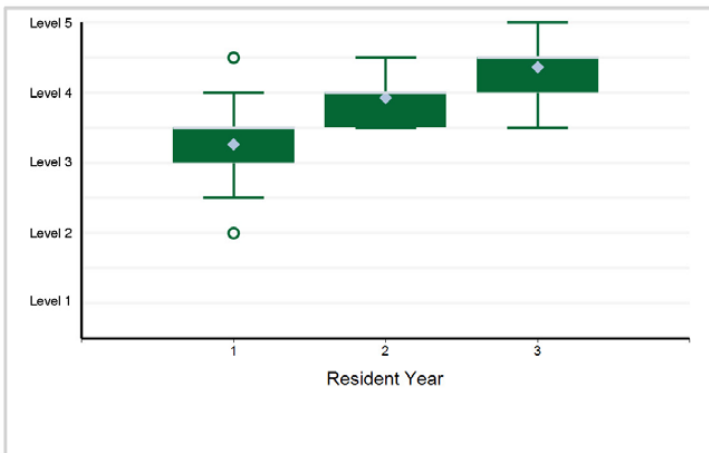

3. Patient Care - PC3. Develop and carry out management plans

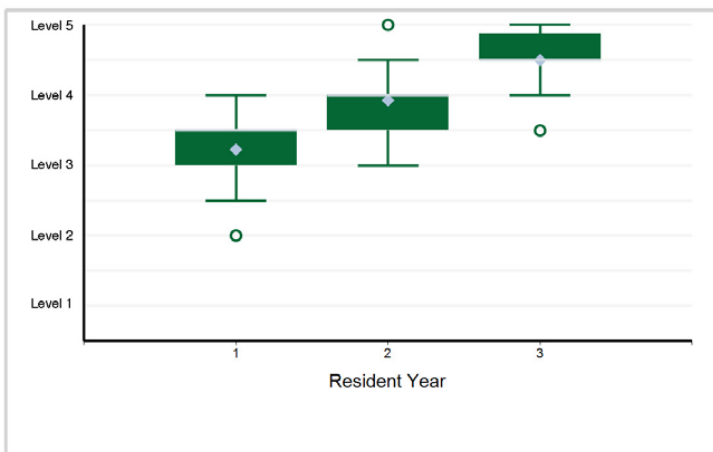

4. Patient Care - PC4. Provide appropriate role modeling

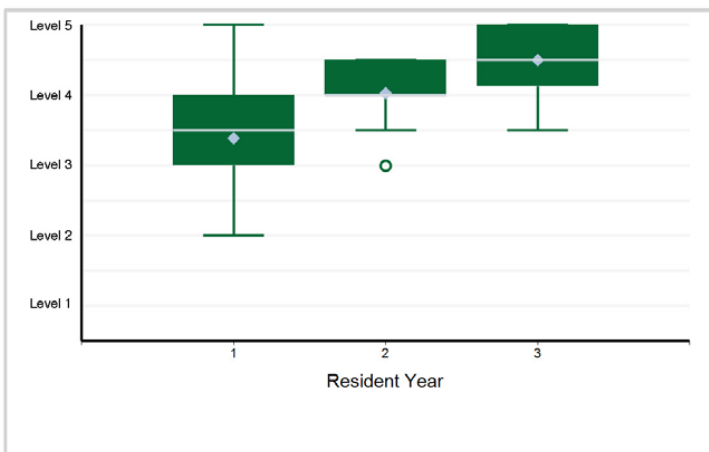

5. Medical Knowledge - MK1. Locate, appraise, and assimilate evidence from scientific studies related to ...

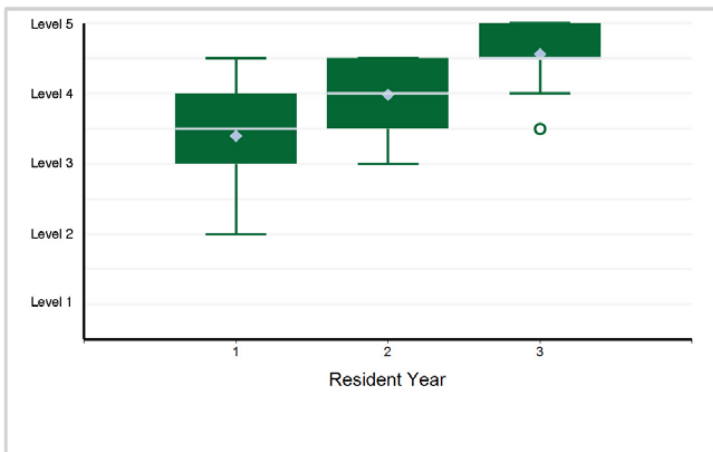

6. Systems-Based Practice - SBP1. Work effectively in various health care delivery settings and systems ...

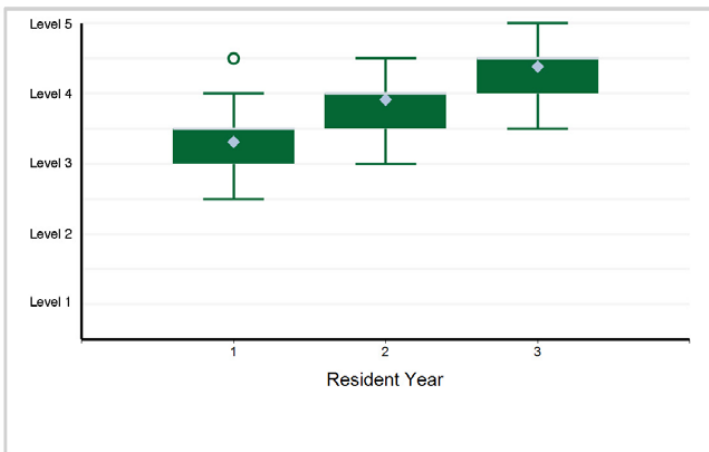

Specialty Box Plot Report - Milestone Evaluation by Resident Year: Year-End 2021-2022

SUBSPECIALTY: Pediatric Rheumatology

7. Systems-Based Practice - SBP2. Coordinate patient care within the health care system relevant to their clinical specialty

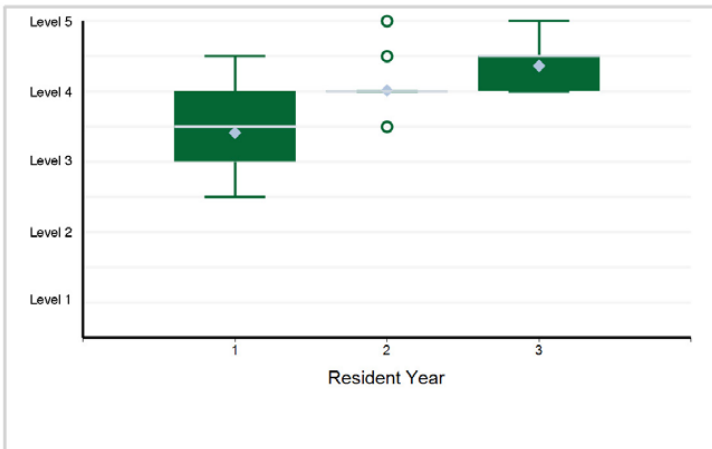

8. Systems-Based Practice - SBP3. Incorporate considerations of cost awareness and risk-benefit analysis in patient and/or ...

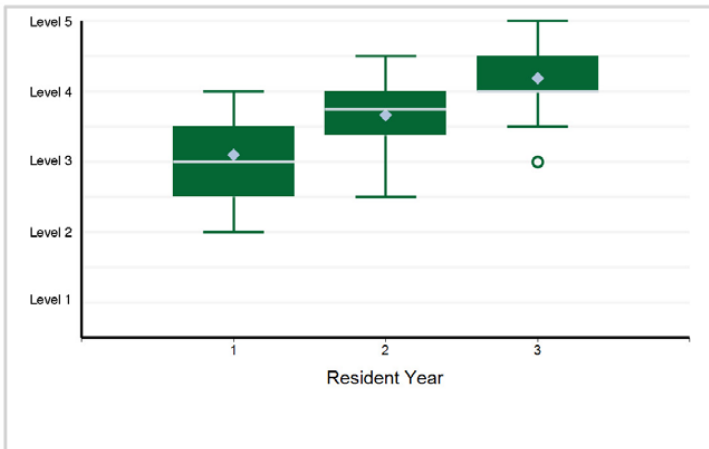

9. Systems-Based Practice - SBP4. Work in interprofessional teams to enhance patient safety and improve patient care quality

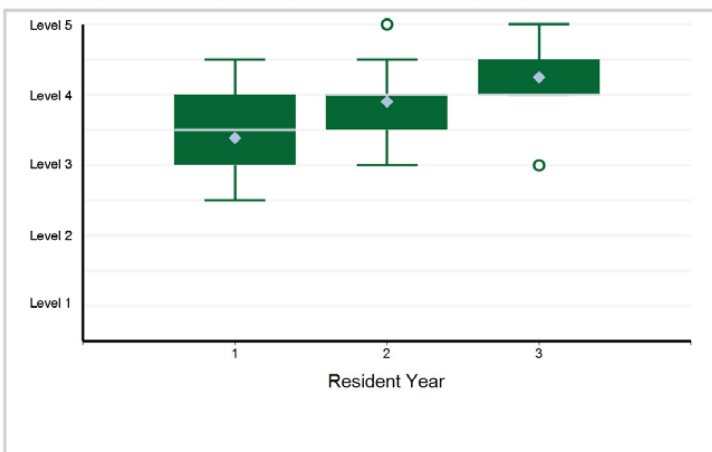

10. Systems-Based Practice - SBP5. Participate in identifying system errors and implementing potential systems solutions

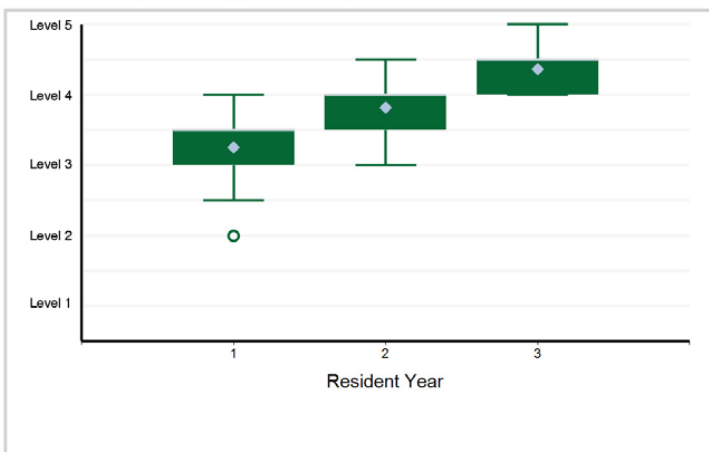

11. Practice-Based Learning and Improvement - PBLI1. Identify strengths, deficiencies, and limits in one's knowledge and expertise

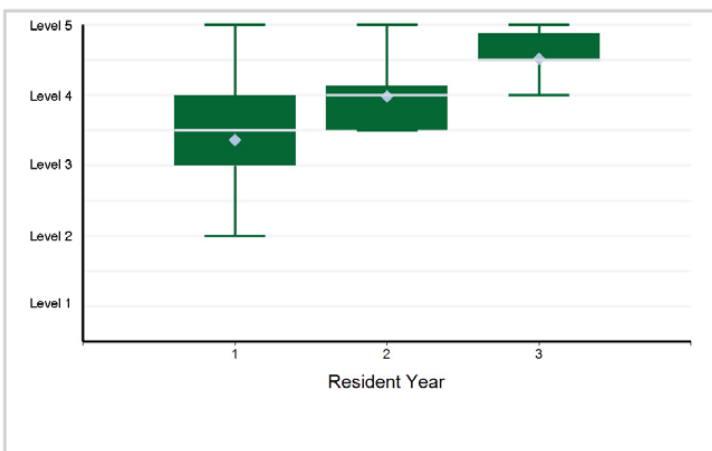

12. Practice-Based Learning and Improvement - PBLI2. Systematically analyze practice using quality improvement methods, and ...

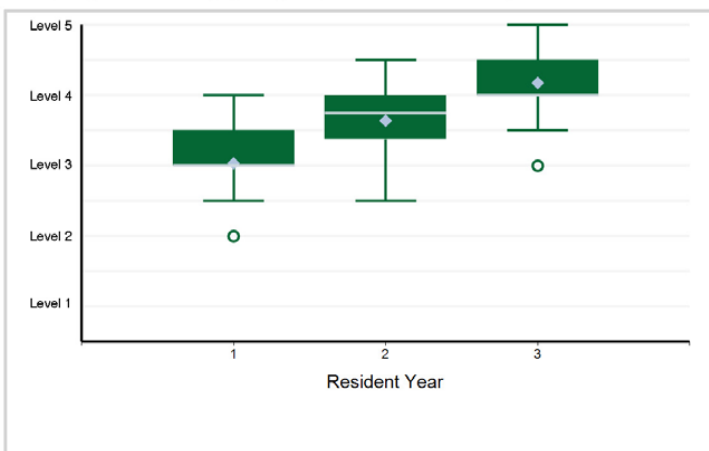

Specialty Box Plot Report - Milestone Evaluation by Resident Year: Year-End 2021-2022

SUBSPECIALTY: Pediatric Rheumatology

13. Practice-Based Learning and Improvement - PBLI3. Use information technology to optimize learning and care delivery

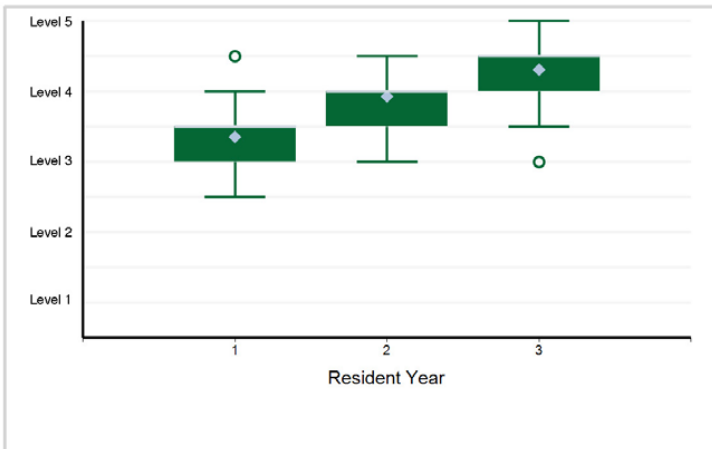

14. Practice-Based Learning and Improvement - PBLI4. Participate in the education of patients, families, ...

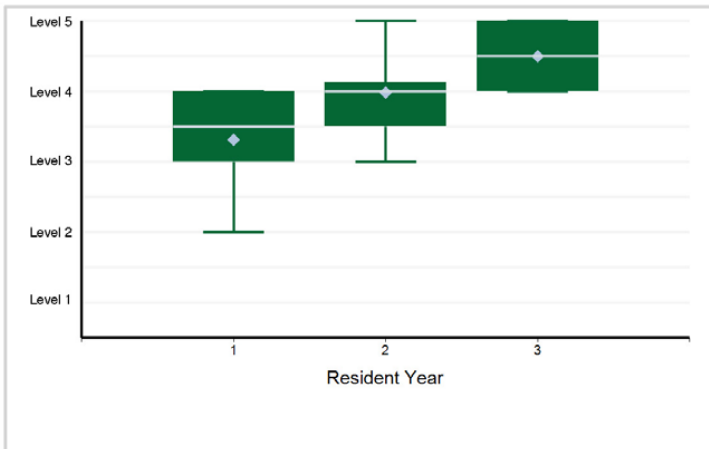

15. Professionalism - PROF1. Professional Conduct: High standards of ethical behavior which includes maintaining ...

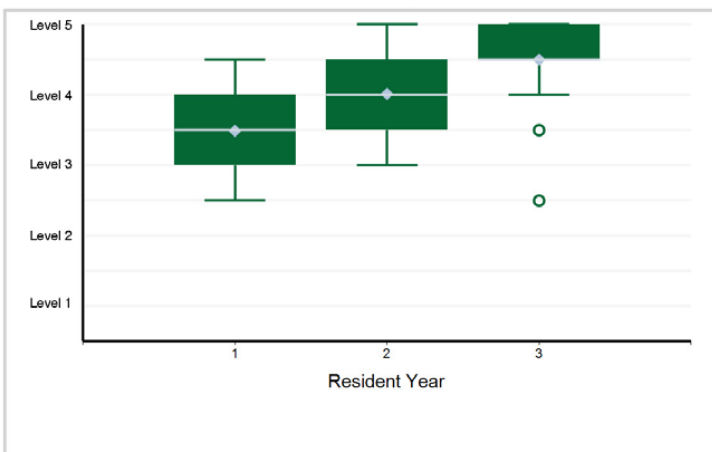

16. Professionalism - PROF2. Trustworthiness that makes colleagues feel secure when one is responsible for the care of patients

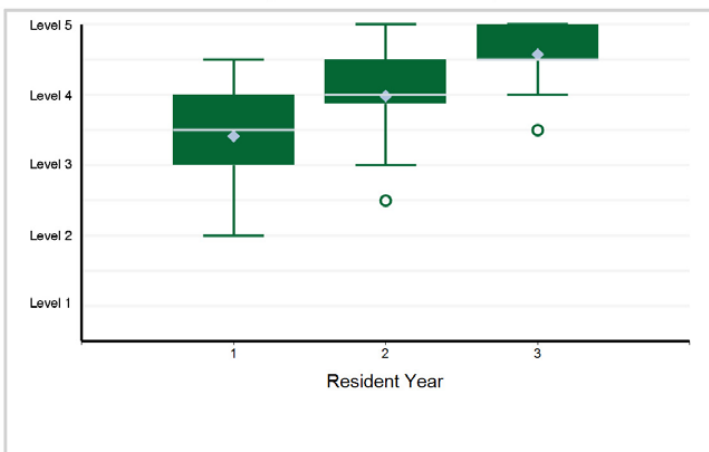

17. Professionalism - PROF3. Provide leadership skills that enhance team functioning, the learning environment, ...

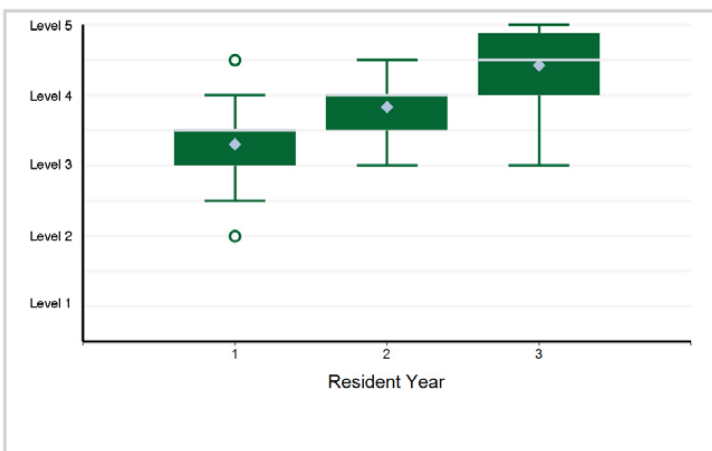

18. Professionalism - PROF4. The capacity to accept that ambiguity is part of clinical medicine and to recognize ...

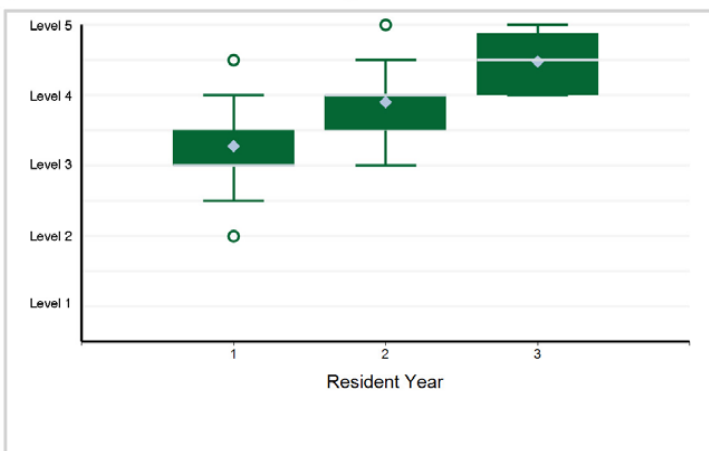

Specialty Box Plot Report - Milestone Evaluation by Resident Year: Year-End 2021-2022

SUBSPECIALTY: Pediatric Rheumatology

19. Interpersonal and Communication Skills - ICS1. Communicate effectively with physicians, other health professionals, and ...

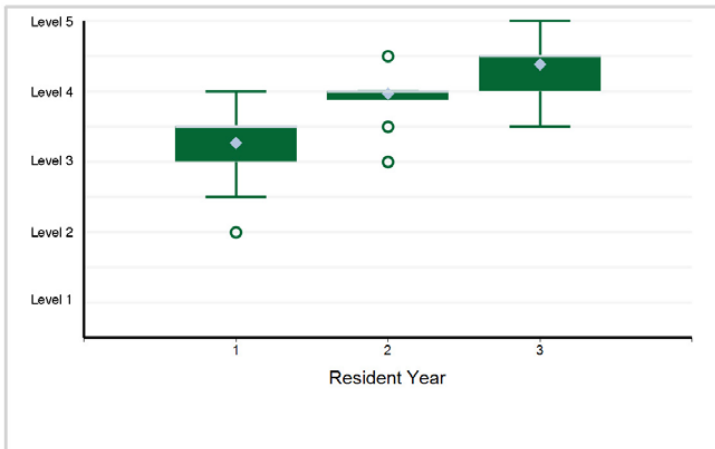

20. Interpersonal and Communication Skills - ICS2. Work effectively as a member or leader of a health care ...

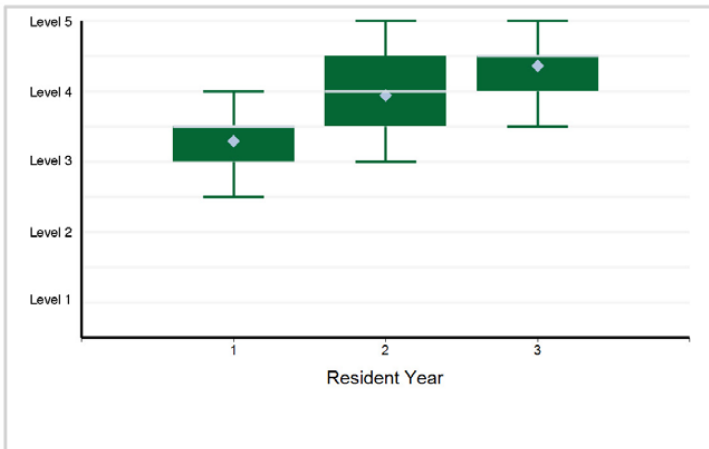

21. Interpersonal and Communication Skills - ICS3. Act in a consultative role to other physicians and health professionals

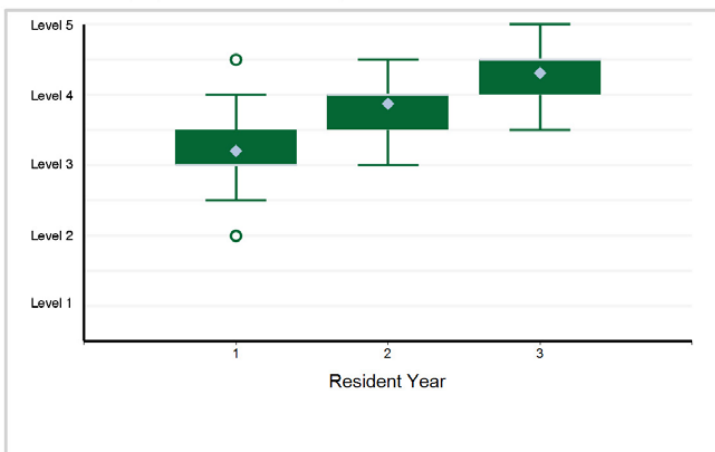

Specialty Box Plot Report - Milestone Evaluation by Resident Year: Year-End 2021-2022

TABLE 110: SUBSPECIALTY: **Pediatric Transplant Hepatology**

Resident Year	1	Total Residents
# of Residents	16	16

1. Patient Care - PC1. Provide transfer of care that ensures seamless transitions

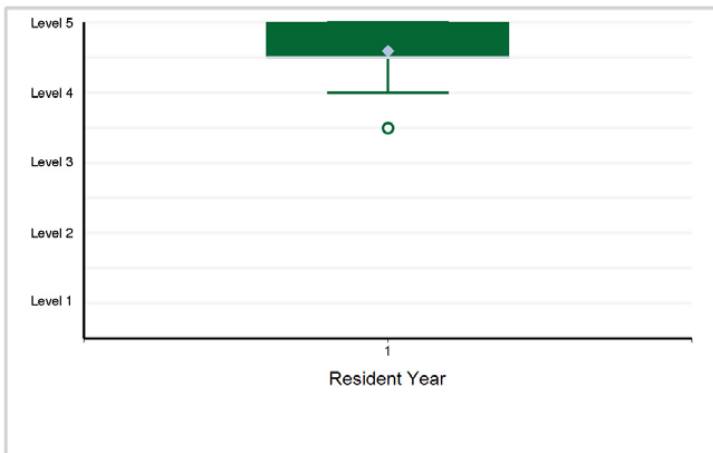

2. Patient Care - PC2. Make informed diagnostic and therapeutic decisions that result in optimal clinical judgment

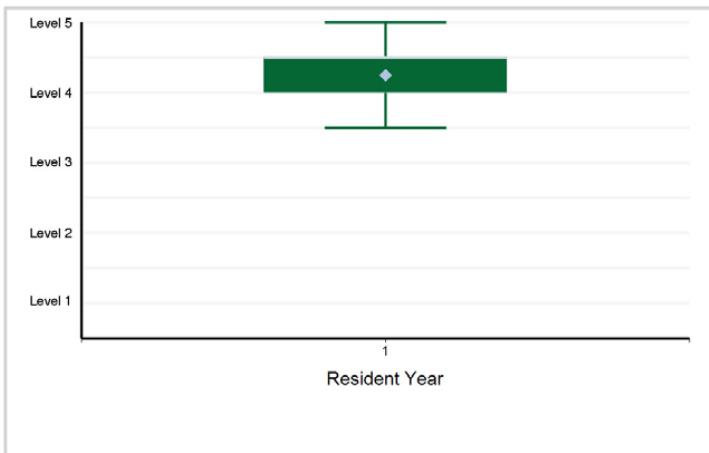

3. Patient Care - PC3. Develop and carry out management plans

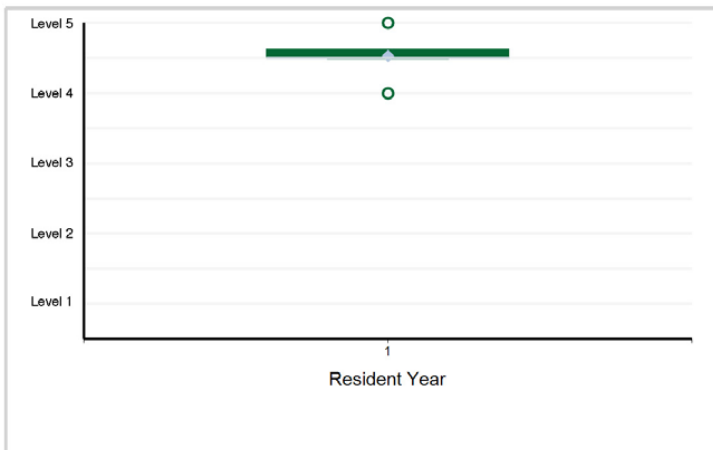

4. Patient Care - PC4. Provide appropriate role modeling

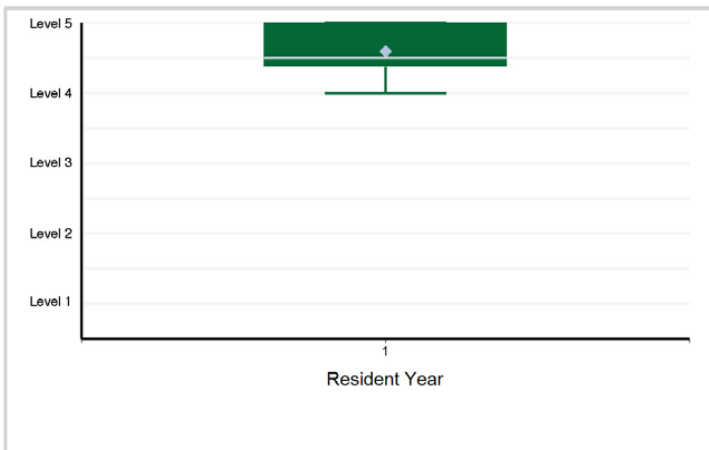

5. Medical Knowledge - MK1. Locate, appraise, and assimilate evidence from scientific studies related to ...

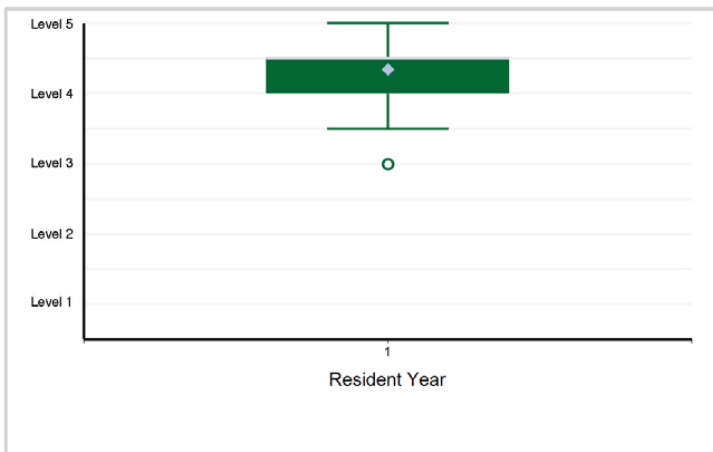

6. Systems-Based Practice - SBP1. Work effectively in various health care delivery settings and systems ...

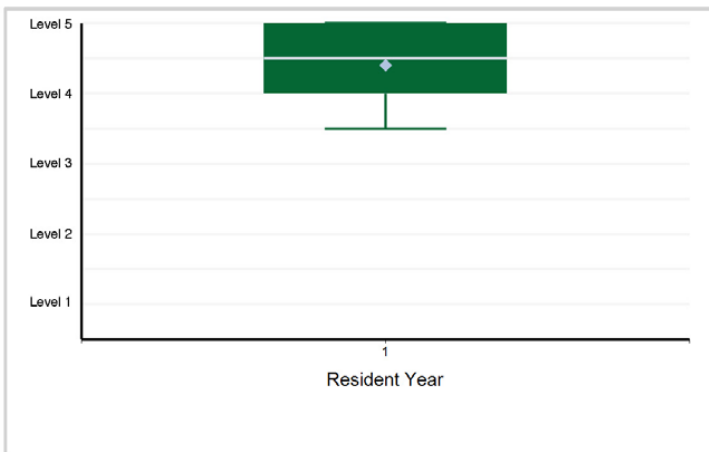

Specialty Box Plot Report - Milestone Evaluation by Resident Year: Year-End 2021-2022

SUBSPECIALTY: Pediatric Transplant Hepatology

7. Systems-Based Practice - SBP2. Coordinate patient care within the health care system relevant to their clinical specialty

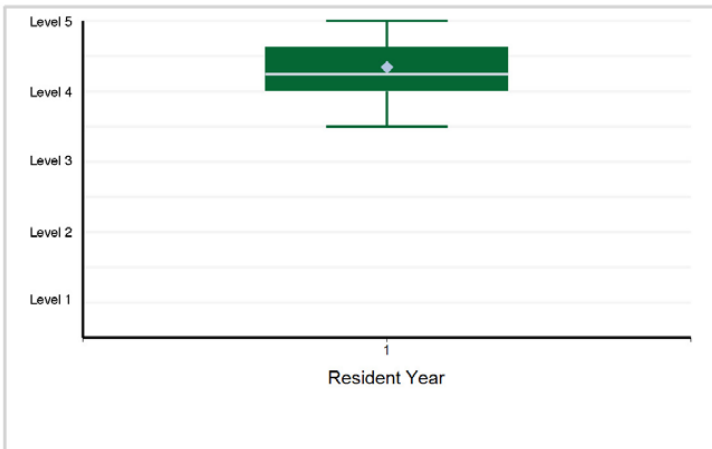

8. Systems-Based Practice - SBP3. Incorporate considerations of cost awareness and risk-benefit analysis in patient and/or ...



9. Systems-Based Practice - SBP4. Work in interprofessional teams to enhance patient safety and improve patient care quality

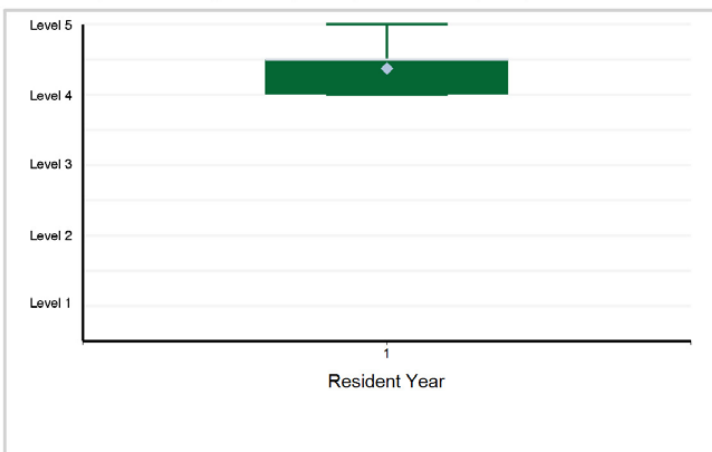

10. Systems-Based Practice - SBP5. Participate in identifying system errors and implementing potential systems solutions

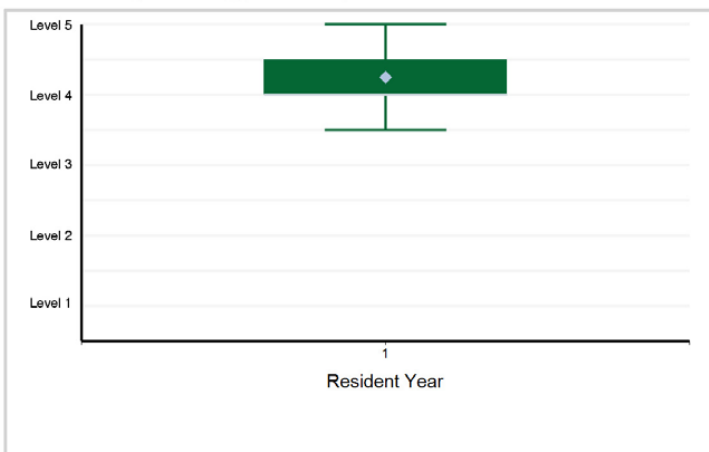

11. Practice-Based Learning and Improvement - PBLI1. Identify strengths, deficiencies, and limits in one's knowledge and expertise

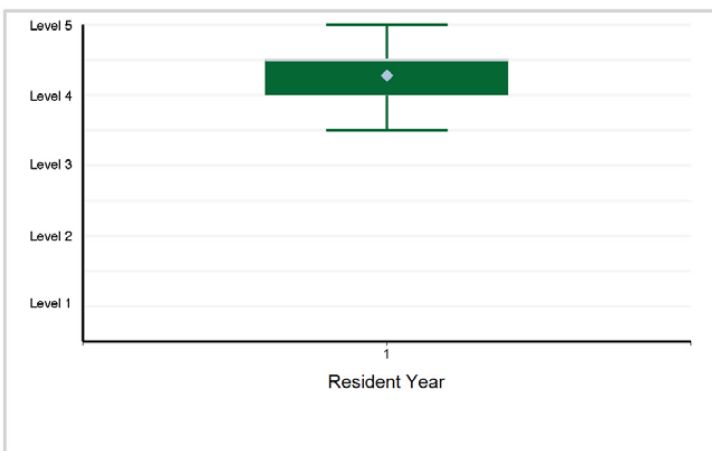

12. Practice-Based Learning and Improvement - PBLI2. Systematically analyze practice using quality improvement methods, and ...

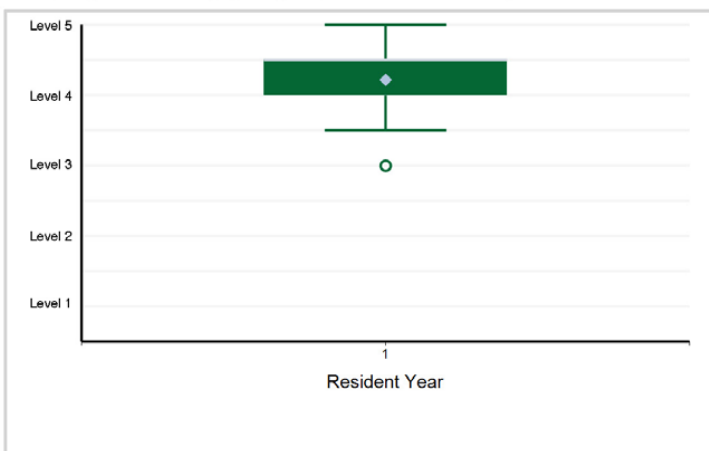

Specialty Box Plot Report - Milestone Evaluation by Resident Year: Year-End 2021-2022

SUBSPECIALTY: Pediatric Transplant Hepatology

13. Practice-Based Learning and Improvement - PBLI3. Use information technology to optimize learning and care delivery

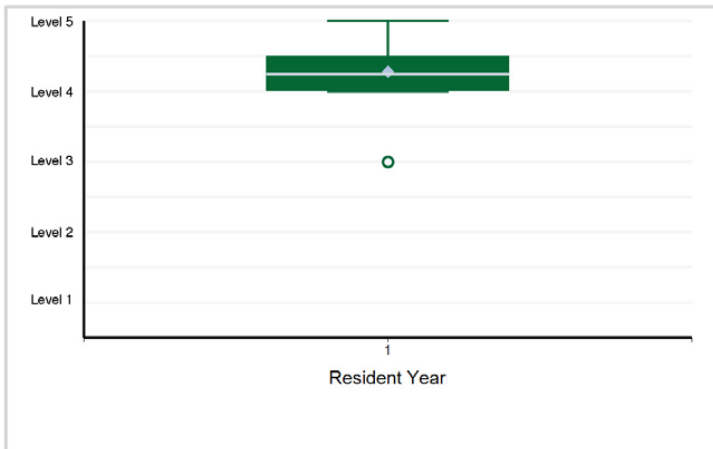

14. Practice-Based Learning and Improvement - PBLI4. Participate in the education of patients, families, ...

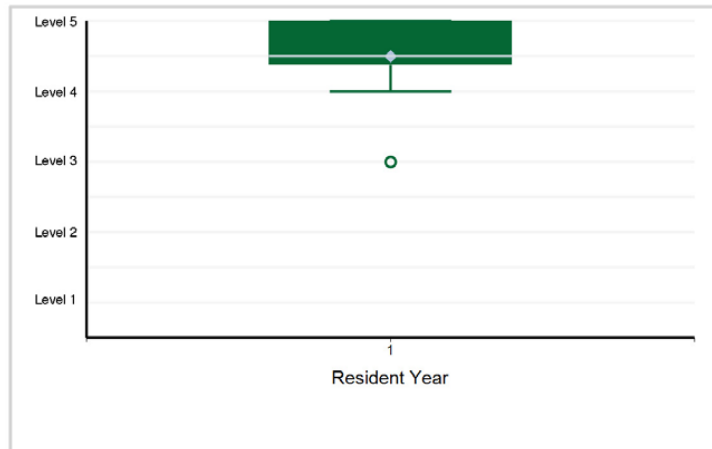

15. Professionalism - PROF1. Professional Conduct: High standards of ethical behavior which includes maintaining ...

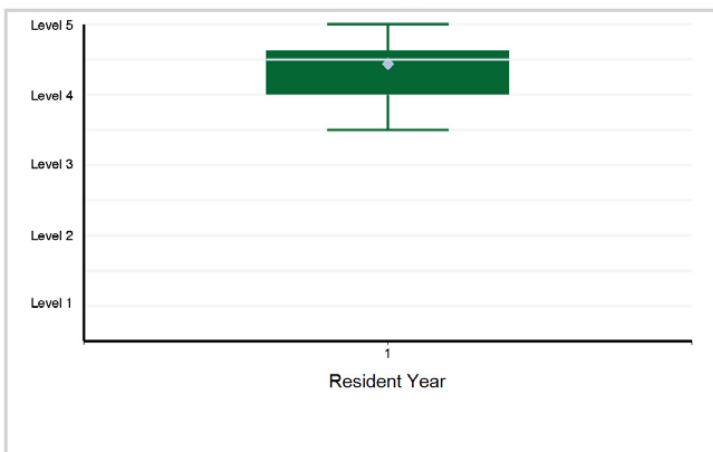

16. Professionalism - PROF2. Trustworthiness that makes colleagues feel secure when one is responsible for the care of patients

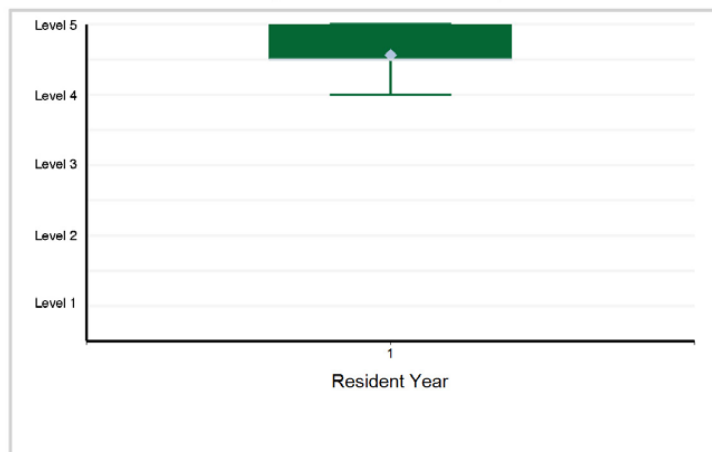

17. Professionalism - PROF3. Provide leadership skills that enhance team functioning, the learning environment, ...



18. Professionalism - PROF4. The capacity to accept that ambiguity is part of clinical medicine and to recognize ...

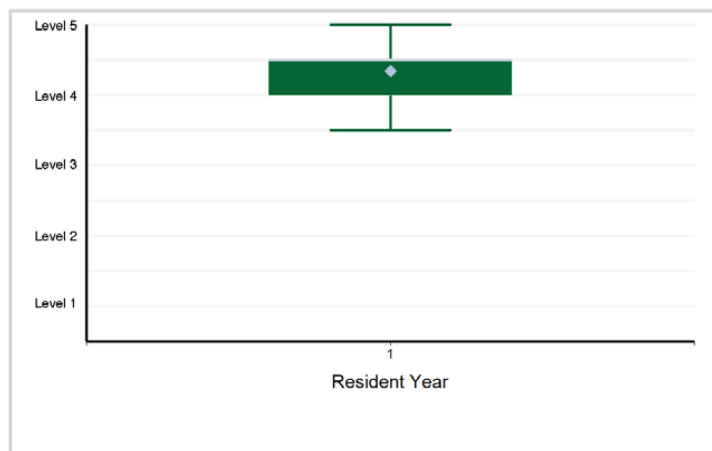

Specialty Box Plot Report - Milestone Evaluation by Resident Year: Year-End 2021-2022

SUBSPECIALTY: Pediatric Transplant Hepatology

19. Interpersonal and Communication Skills - ICS1. Communicate effectively with physicians, other health professionals, and ...

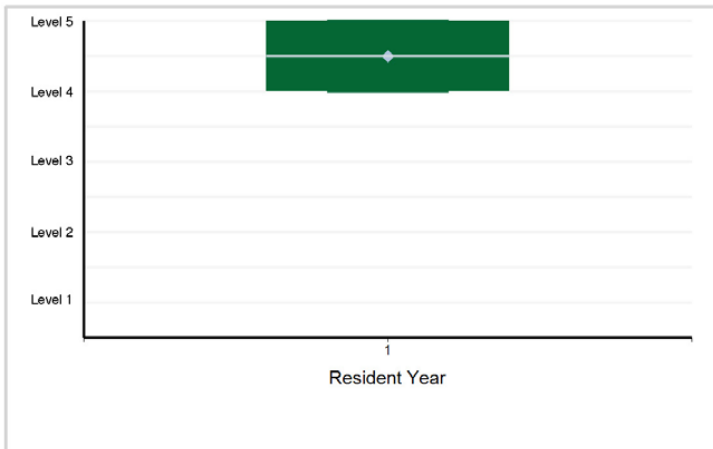

20. Interpersonal and Communication Skills - ICS2. Work effectively as a member or leader of a health care ...

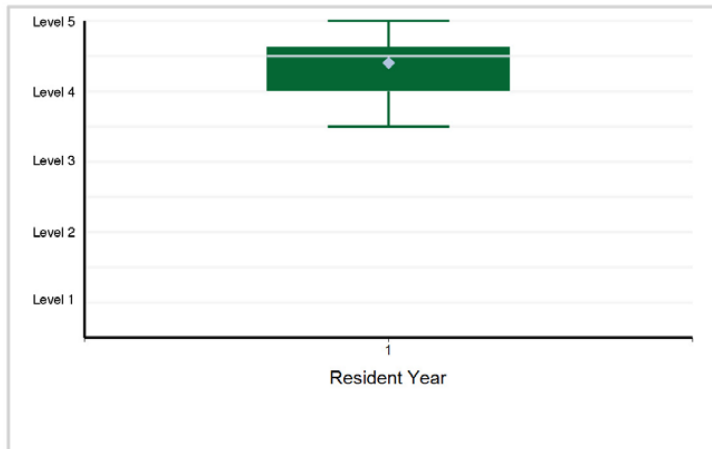

21. Interpersonal and Communication Skills - ICS3. Act in a consultative role to other physicians and health professionals

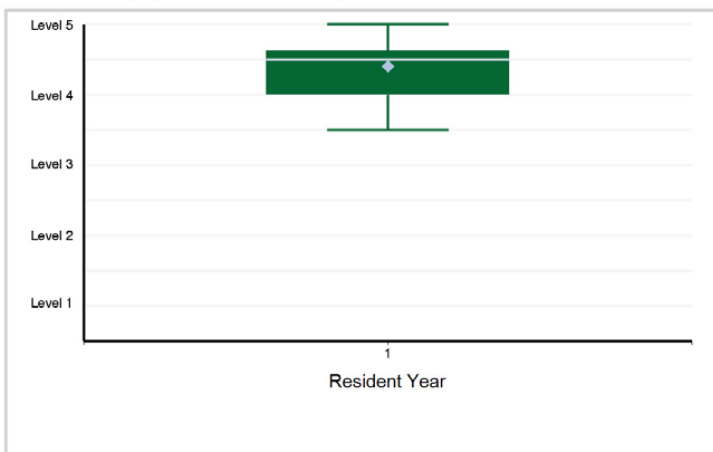

Specialty Box Plot Report - Milestone Evaluation by Resident Year: Year-End 2021-2022

TABLE 111: SUBSPECIALTY: **Sports Medicine (multidisciplinary, Pediatrics)**

Resident Year	1	Total Residents
# of Residents	28	28

1. Patient Care - History and Physical Examination: Medical and Musculoskeletal — Patient Care 1

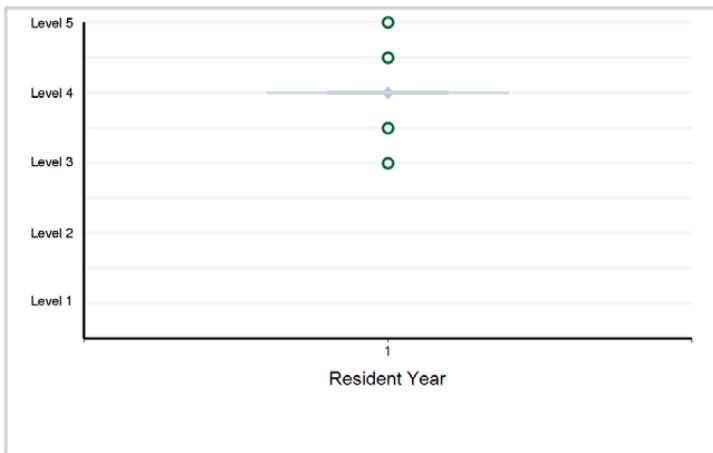

2. Patient Care - Medical Management: Differential Diagnosis, Diagnostic Testing, Interpretation of Data ...

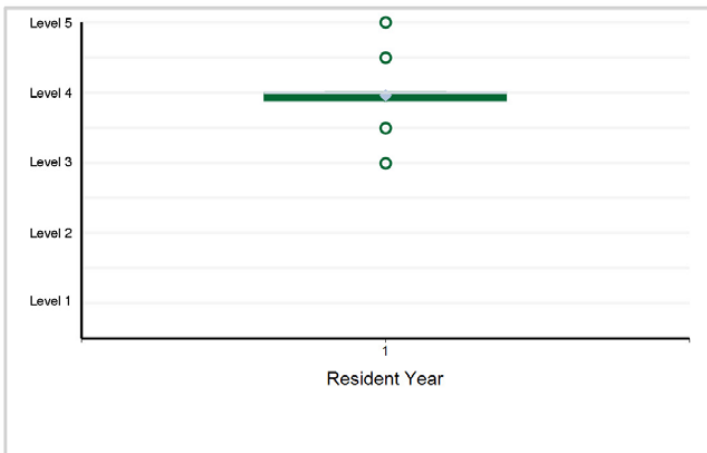

3. Patient Care - Team Coverage and Athletic Care: Coverage of Sporting Events, Pre-participation Physical ...



4. Medical Knowledge - Science of Sports Medicine, including Anatomy, Physiology, Cellular Biology, Epidemiology, ...

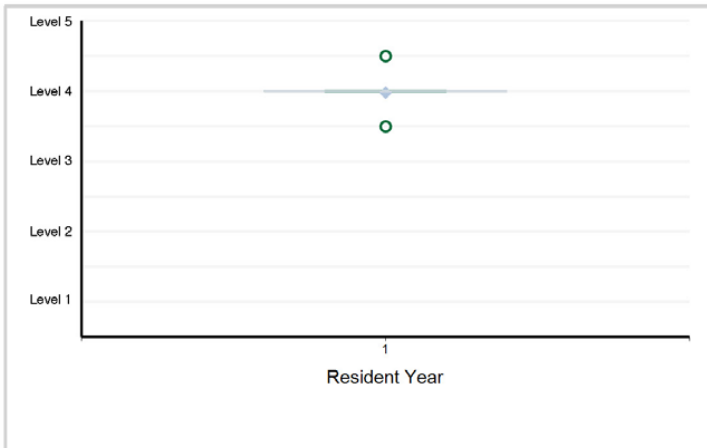

5. Medical Knowledge - Medical Issues in Sports Medicine — Medical Knowledge 2

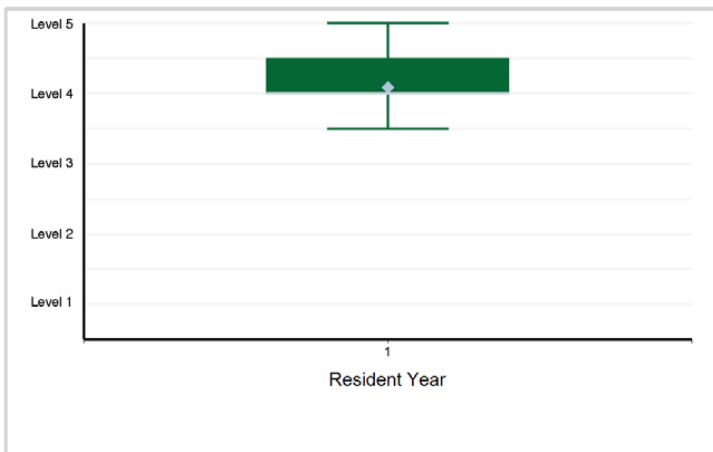

6. Medical Knowledge - Musculoskeletal Issues in Sports Medicine — Medical Knowledge 3



Specialty Box Plot Report - Milestone Evaluation by Resident Year: Year-End 2021-2022

SUBSPECIALTY: Sports Medicine (multidisciplinary, Pediatrics)

7. Systems-Based Practice - Working with Interprofessional Teams (consultants, certified athletic trainers ...)

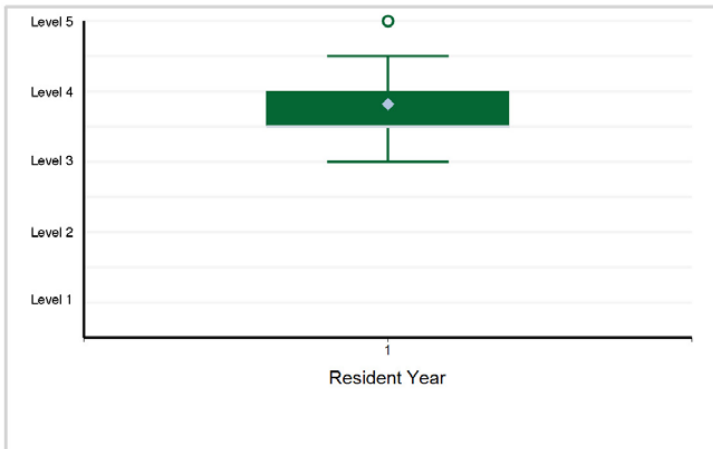

8. Systems-Based Practice - Systems Thinking — Systems-Based Practice 2

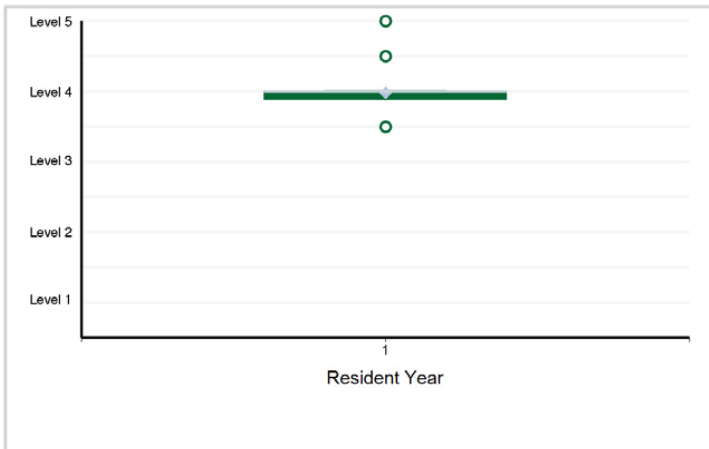

9. Practice-Based Learning and Improvement - Self-directed Learning — Practice-Based Learning and Improvement ...

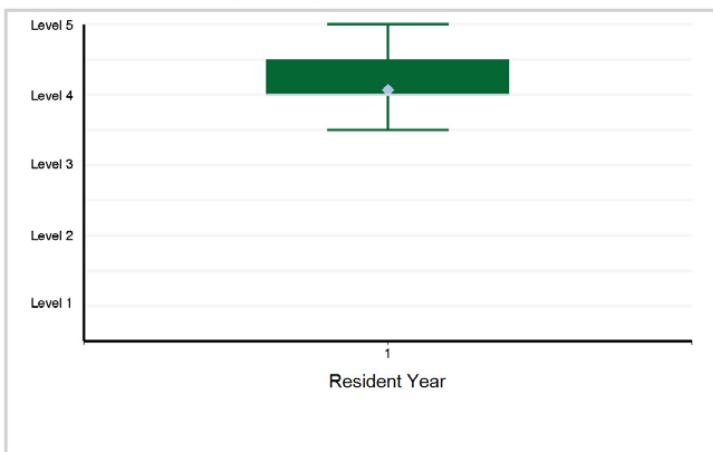

10. Practice-Based Learning and Improvement - Locate, Appraise, and Assimilate Evidence from Scientific ...



11. Professionalism - Compassion, Integrity, Accountability, and Respect for Self and Others — Professionalism 1

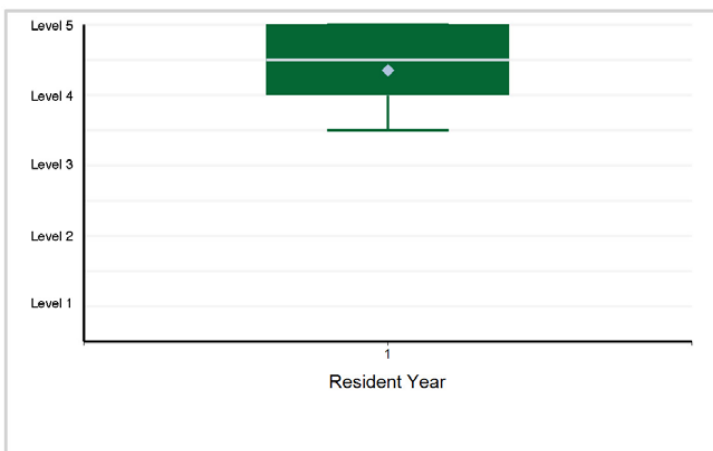

12. Professionalism - Knowledge about and Adherence to the Ethical Principles Relevant to the Practice of Sports Medicine — ...

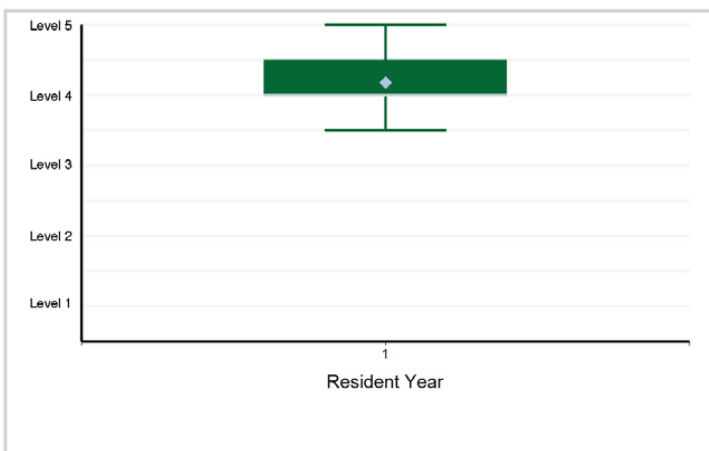

Specialty Box Plot Report - Milestone Evaluation by Resident Year: Year-End 2021-2022

SUBSPECIALTY: Sports Medicine (multidisciplinary, Pediatrics)

13. Interpersonal and Communication Skills - Relationship Development, Teamwork, and Managing Conflict — ...

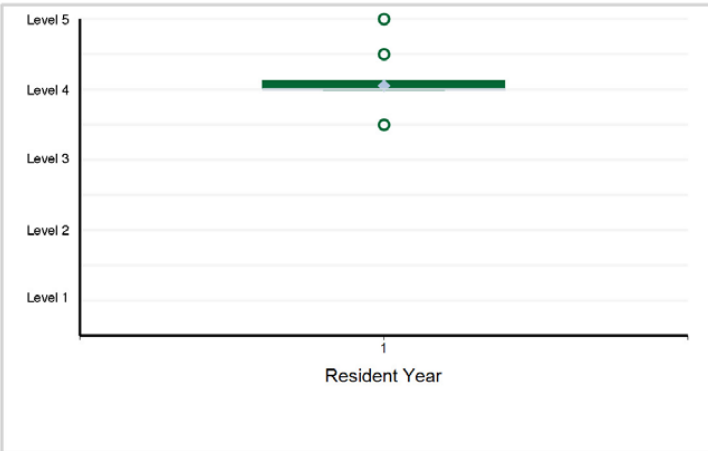

14. Interpersonal and Communication Skills - Information Sharing, Gathering, and Technology — Interpersonal ...

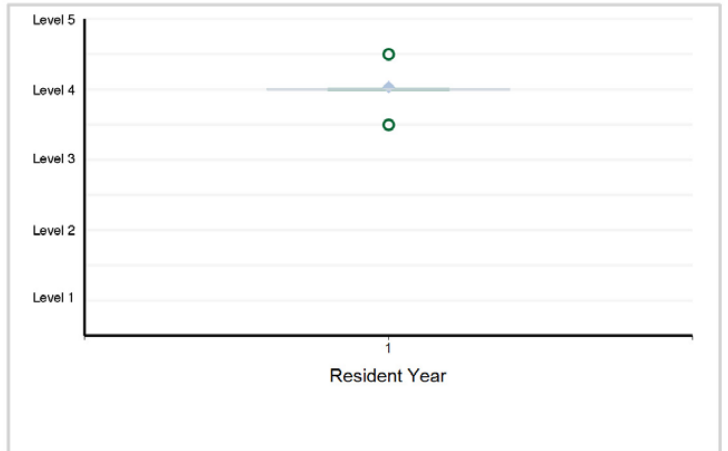

Specialty Box Plot Report - Milestone Evaluation by Resident Year: Year-End 2021-2022

TABLE 112: SPECIALTY: **Physical Medicine and Rehabilitation**

Resident Year	1	2	3	4	Total Residents
# of Residents	169	489	468	454	1,580

1. Patient Care - Patient Care 1: Psychiatric History, Appropriate for Age and Impairment

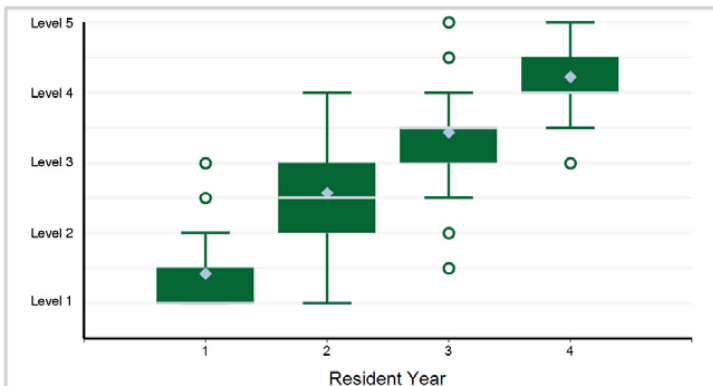

Note: 1 of 1,580 residents have a status of "Not Yet Assessable" and are not included in the analysis.

2. Patient Care - Patient Care 2: Physical Examination

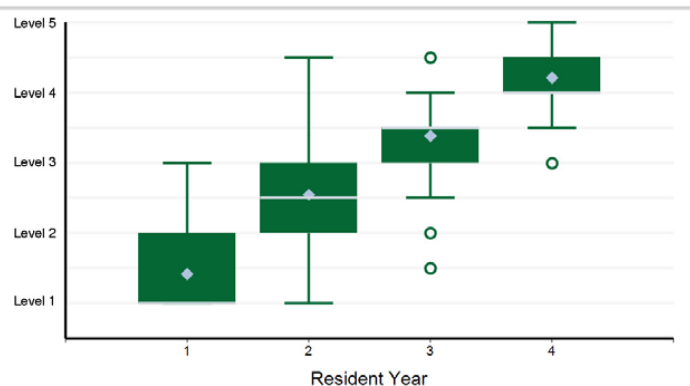

Note: 1 of 1,580 residents have a status of "Not Yet Assessable" and are not included in the analysis.

3. Patient Care - Patient Care 3: Medical Management (e.g., Inpatient, Outpatient, Consultative Settings)

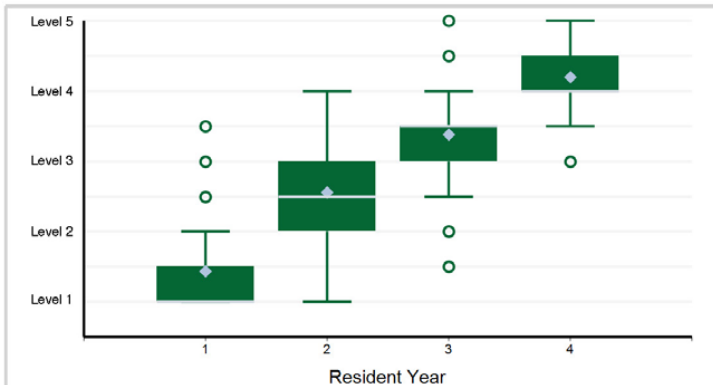

Note: 2 of 1,580 residents have a status of "Not Yet Assessable" and are not included in the analysis.

4. Patient Care - Patient Care 4: Procedural Skills: Injections for Abnormalities of Tone or Movement (e.g., ...)

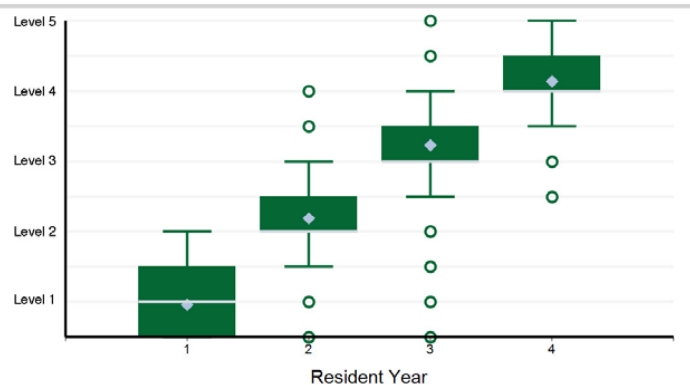

Note: 115 of 1,580 residents have a status of "Not Yet Assessable" and are not included in the analysis.

5. Patient Care - Patient Care 5: Procedural Skills: Joint and Soft Tissue Injections (e.g., Intra-articular, ...)

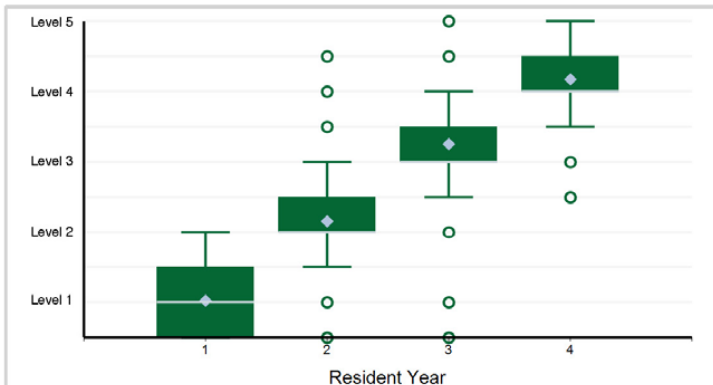

Note: 106 of 1,580 residents have a status of "Not Yet Assessable" and are not included in the analysis.

6. Patient Care - Patient Care 6: Procedural Skills: Electrodiagnostic Procedures (Planning, Performance, and Interpretation)

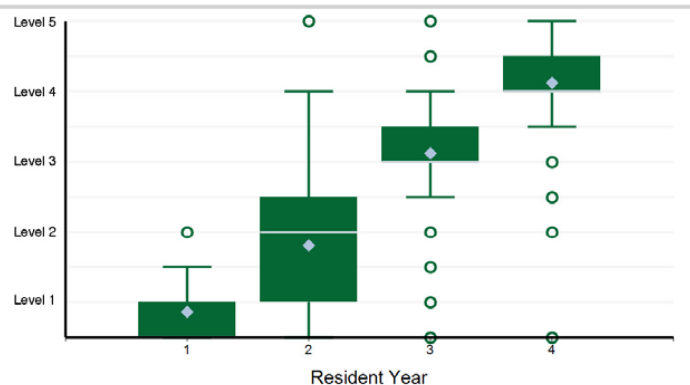

Note: 185 of 1,580 residents have a status of "Not Yet Assessable" and are not included in the analysis.

Specialty Box Plot Report - Milestone Evaluation by Resident Year: Year-End 2021-2022

SPECIALTY: Physical Medicine and Rehabilitation

7. Patient Care - Patient Care 7: Assistive Technologies (e.g., Prosthetics and Orthotics, Adaptive Equipment, ...)

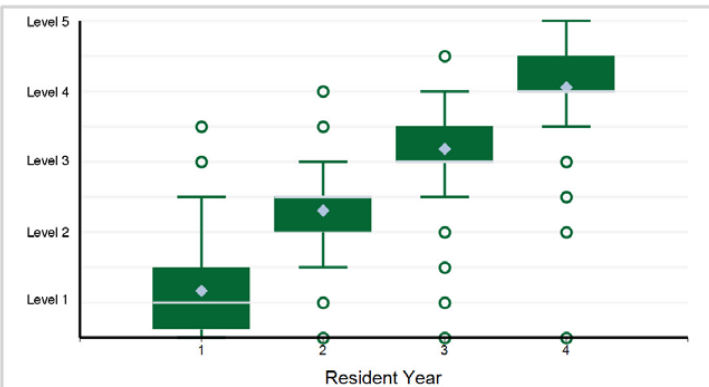

Note: 70 of 1,580 residents have a status of "Not Yet Assessable" and are not included in the analysis.

8. Patient Care - Patient Care 8: Rehabilitation Interventions

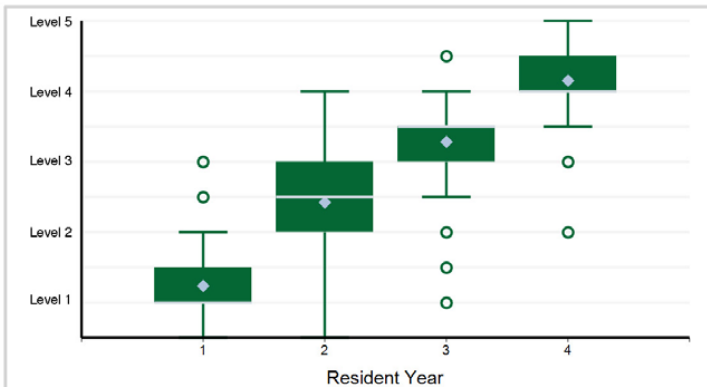

Note: 44 of 1,580 residents have a status of "Not Yet Assessable" and are not included in the analysis.

9. Medical Knowledge - Medical Knowledge 1: Foundational Principles of Psychiatric Practice (Anatomy, Pathophysiology, ...)

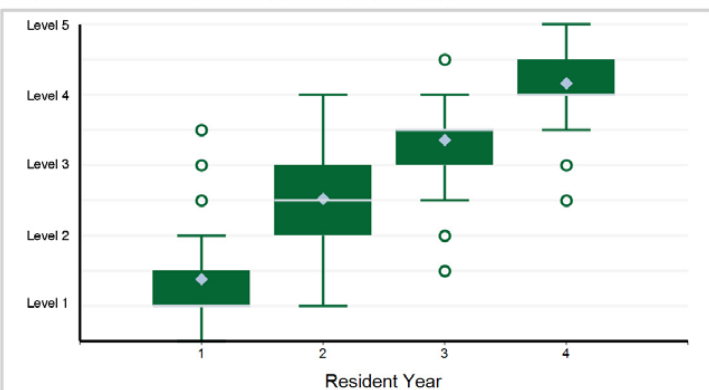

Note: 10 of 1,580 residents have a status of "Not Yet Assessable" and are not included in the analysis.

10. Medical Knowledge - Medical Knowledge 2: Clinical Reasoning

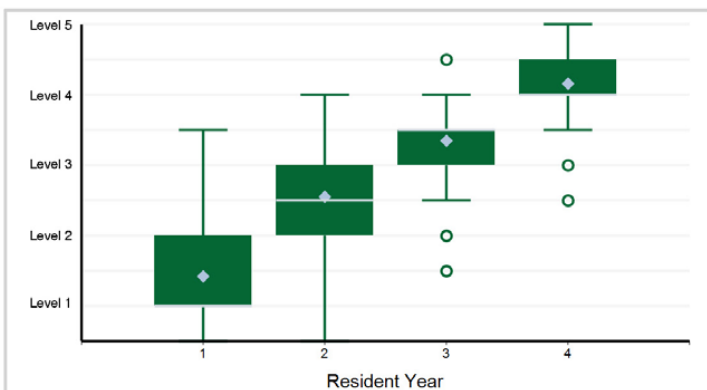

11. Systems-Based Practice - Systems-Based Practice 1: Patient Safety

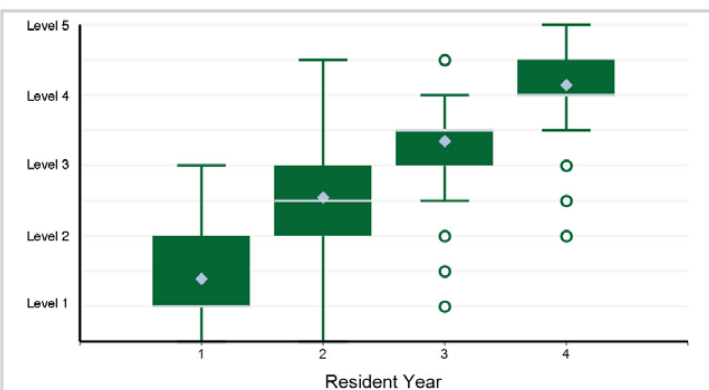

12. Systems-Based Practice - Systems-Based Practice 2: Quality Improvement

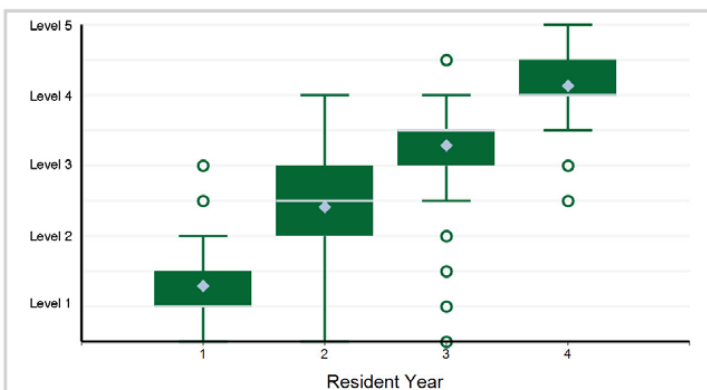

Specialty Box Plot Report - Milestone Evaluation by Resident Year: Year-End 2021-2022

SPECIALTY: Physical Medicine and Rehabilitation

13. Systems-Based Practice - Systems-Based Practice 3: System Navigation for Patient-Centered Care

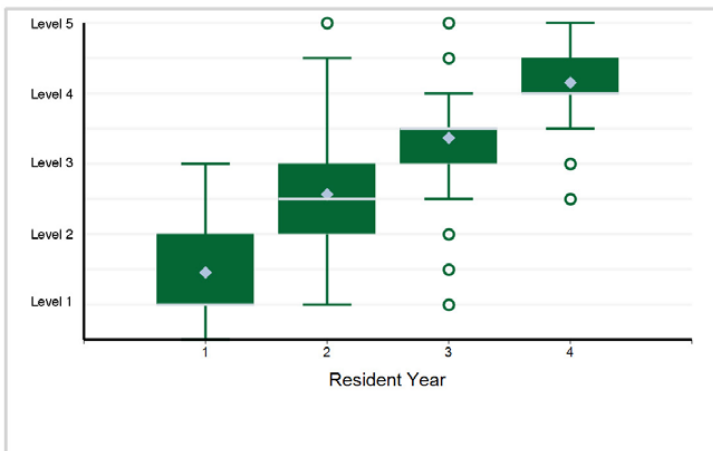

14. Systems-Based Practice - Systems-Based Practice 4: Physician Role in Health Care Systems

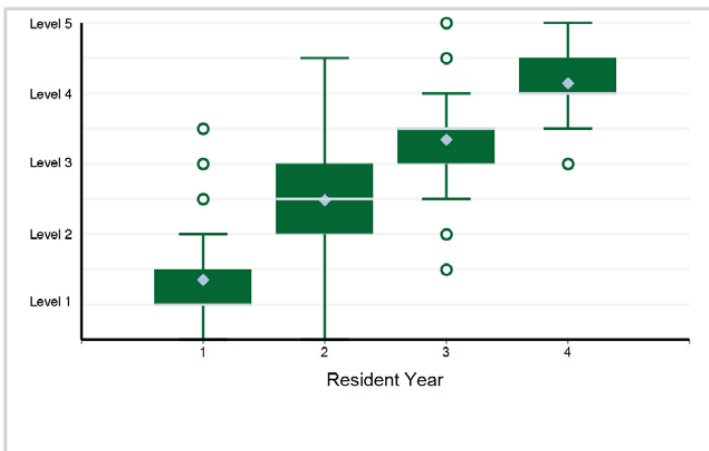

15. Practice-Based Learning and Improvement - Practice-Based Learning and Improvement 1: Evidence-Based and Informed Practice

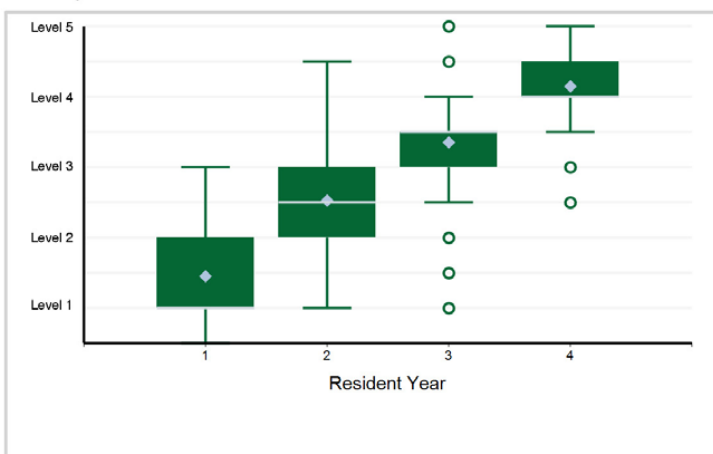

16. Practice-Based Learning and Improvement - Practice-Based Learning and Improvement 2: Reflective Practice and Commitment ...

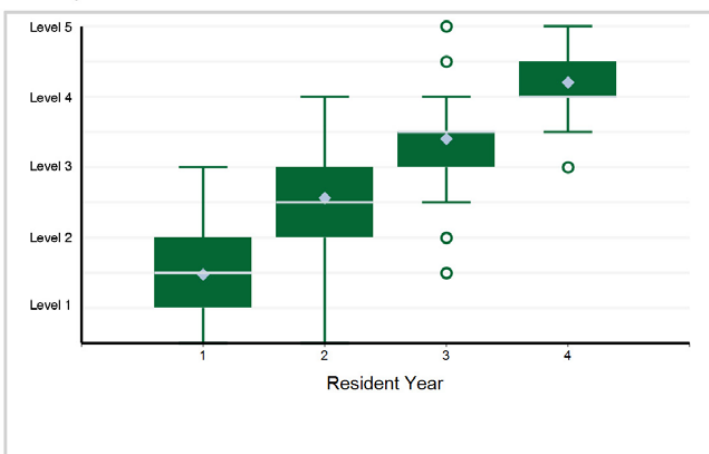

17. Professionalism - Professionalism 1: Ethical Practice

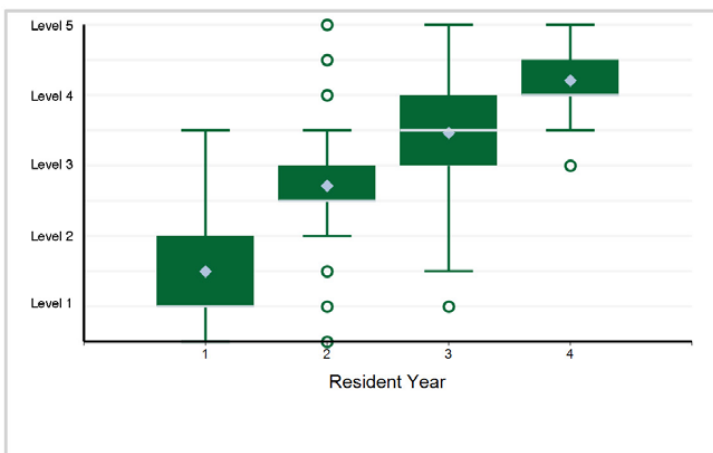

18. Professionalism - Professionalism 2: Professional Behaviors

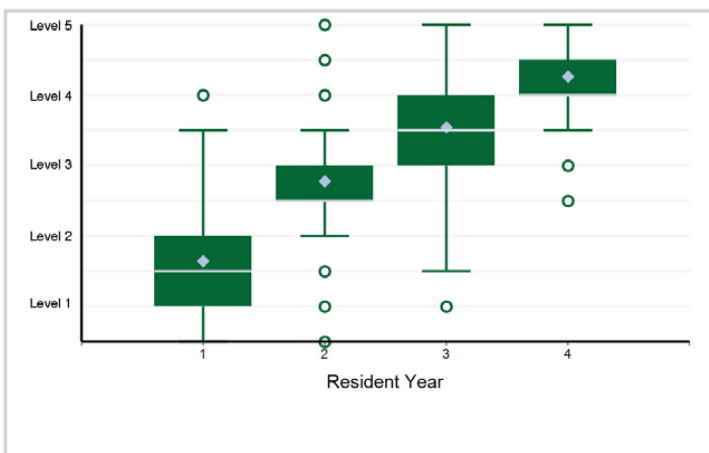

Specialty Box Plot Report - Milestone Evaluation by Resident Year: Year-End 2021-2022

SPECIALTY: Physical Medicine and Rehabilitation

19. Professionalism - Professionalism 3: Accountability

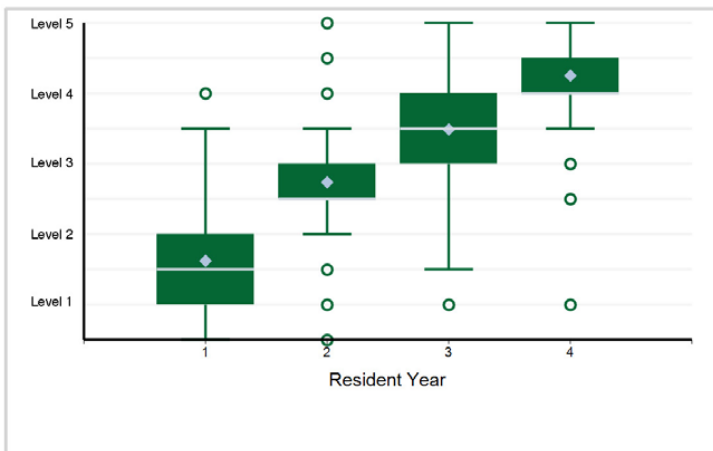

20. Professionalism - Professionalism 4: Patient Care Etiquette with Patients of All Abilities

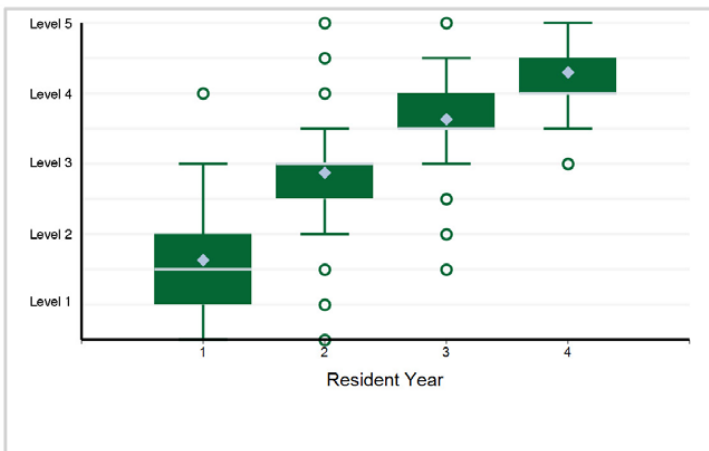

21. Professionalism - Professionalism 5: Resident Well-Being and Help-Seeking

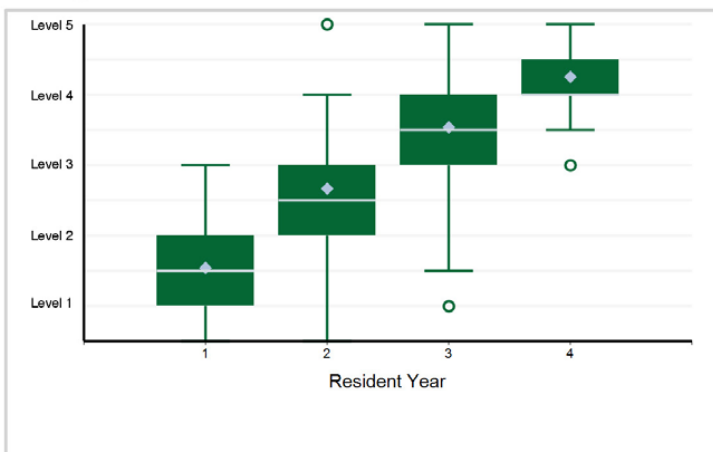

22. Interpersonal and Communication Skills - Interpersonal and Communication Skills 1: Patient- and Family-Centered Communication

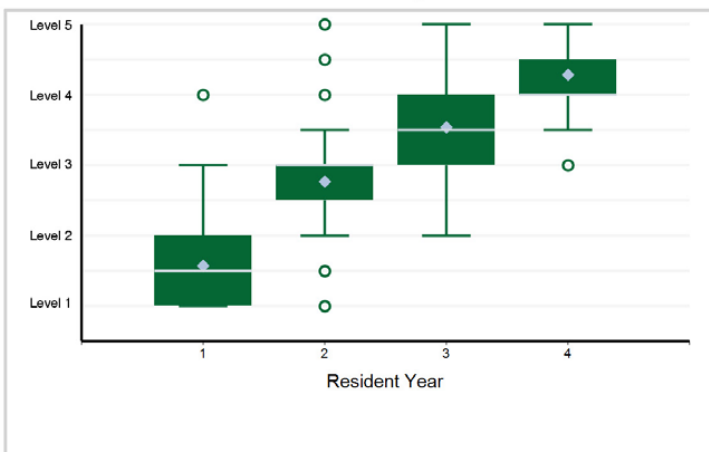

23. Interpersonal and Communication Skills - Interpersonal and Communication Skills 2: Interprofessional and Team Communication

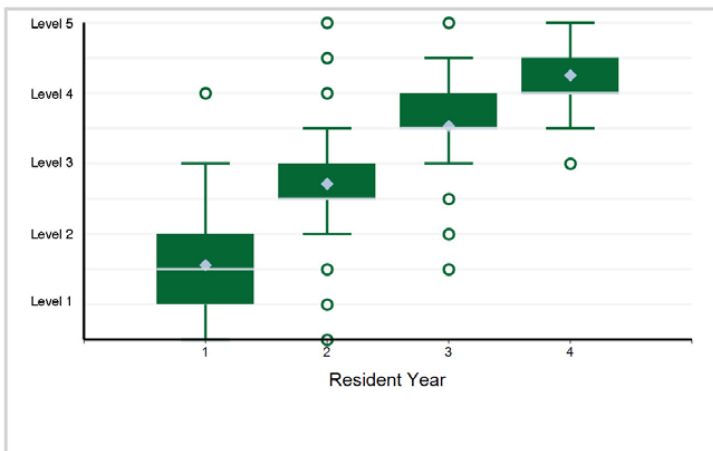

24. Interpersonal and Communication Skills - Interpersonal and Communication Skills 3: Communication within Health Care Systems

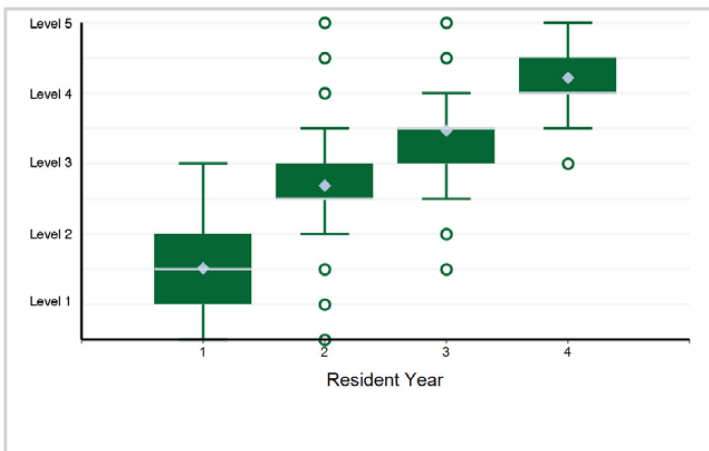

Specialty Box Plot Report - Milestone Evaluation by Resident Year: Year-End 2021-2022

TABLE 113: SUBSPECIALTY: **Brain Injury Medicine (multidisciplinary, Physical Medicine and Rehabilitation)**

Resident Year	1	Total Residents
# of Residents	26	26

1. Patient Care - Patient Care 1: History

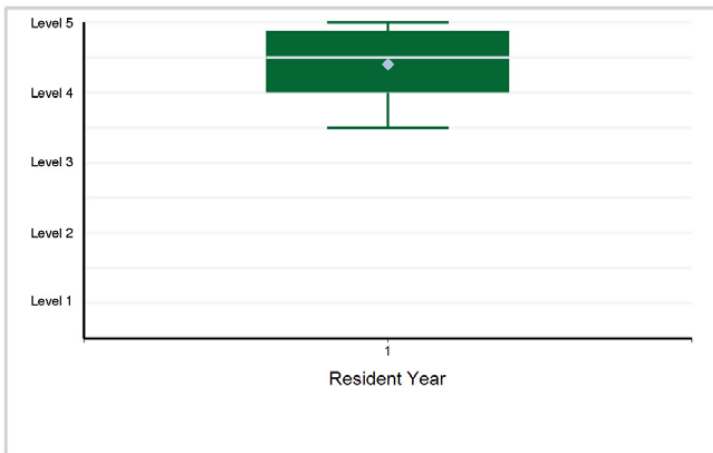

2. Patient Care - Patient Care 2: Physical Examination

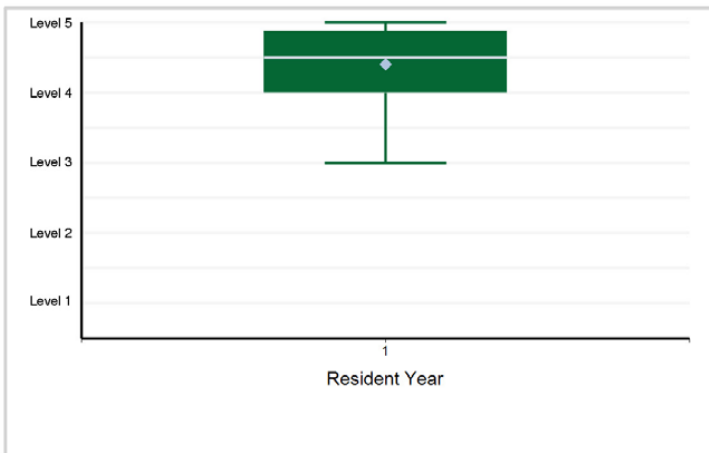

3. Patient Care - Patient Care 3: Spasticity Management

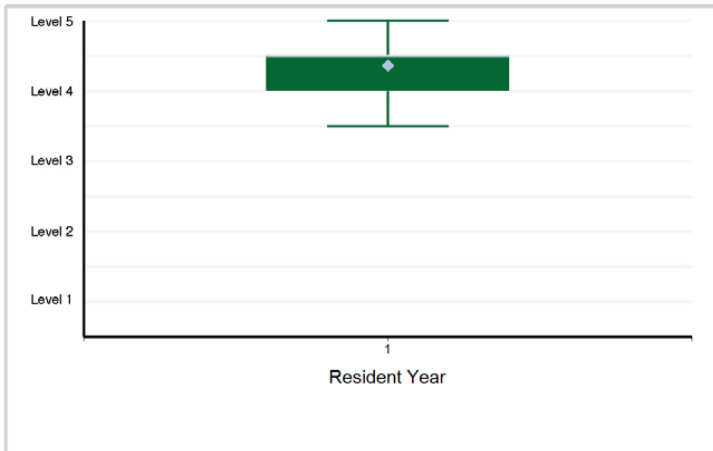

4. Patient Care - Patient Care 4: Evaluation and Diagnosis of Individuals with Brain Injury across the Spectrum of Severity

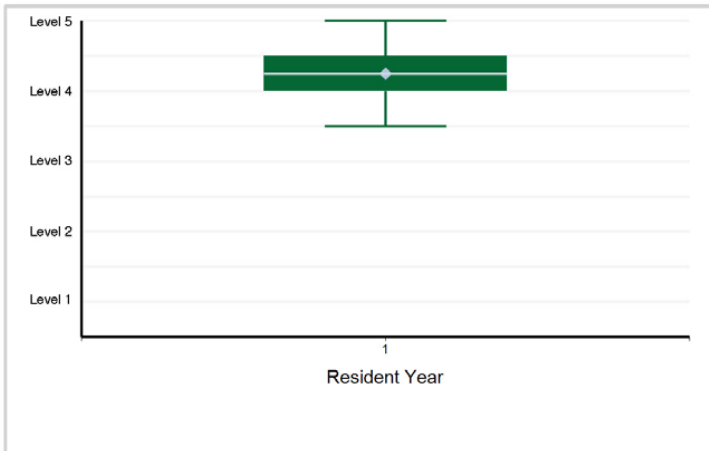

5. Patient Care - Patient Care 5: Medical/Neuropsychiatric Management of Individuals with Brain Injury across the Spectrum ...

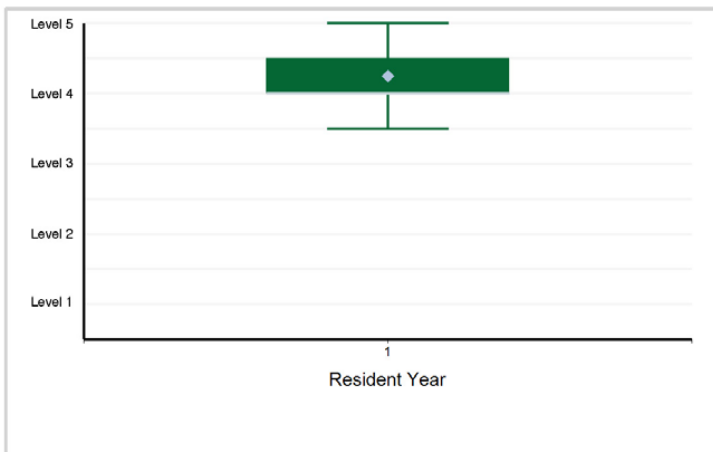

6. Patient Care - Patient Care 6: Therapy and Durable Medical Equipment Management of Individuals with Brain Injury

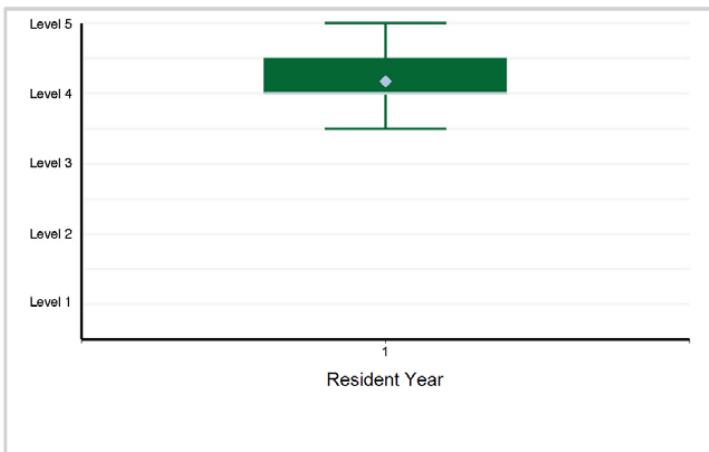

Specialty Box Plot Report - Milestone Evaluation by Resident Year: Year-End 2021-2022

SUBSPECIALTY: **Brain Injury Medicine (multidisciplinary, Physical Medicine and Rehabilitation)**

7. Medical Knowledge - Medical Knowledge 1: Traumatic and Non-Traumatic Brain Injury

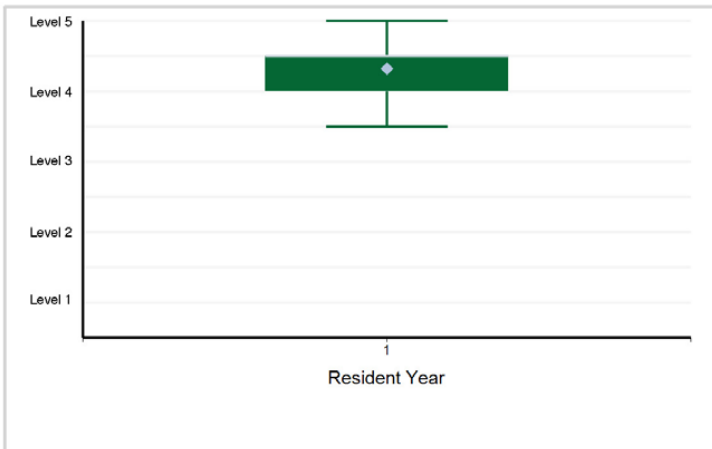

8. Medical Knowledge - Medical Knowledge 2: Functional Outcomes and Assessment across the Entire Spectrum of Brain Injury Severity

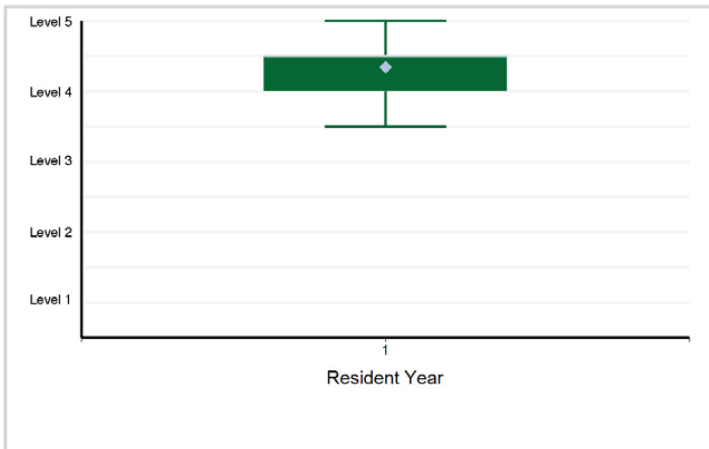

9. Medical Knowledge - Medical Knowledge 3: Clinical Reasoning

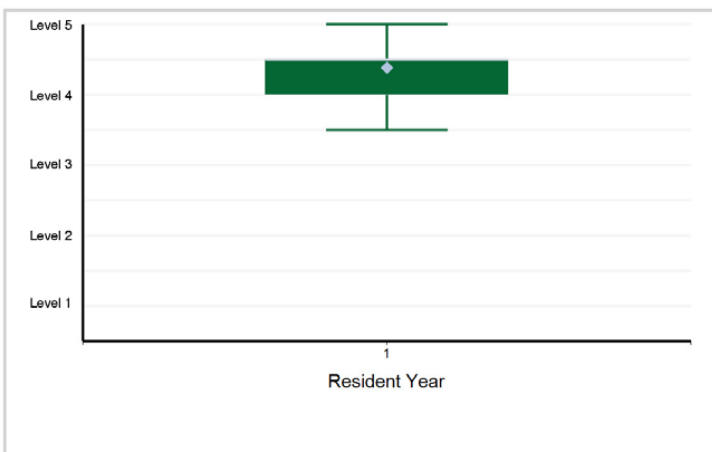

10. Systems-Based Practice - Systems-Based Practice 1: Patient Safety

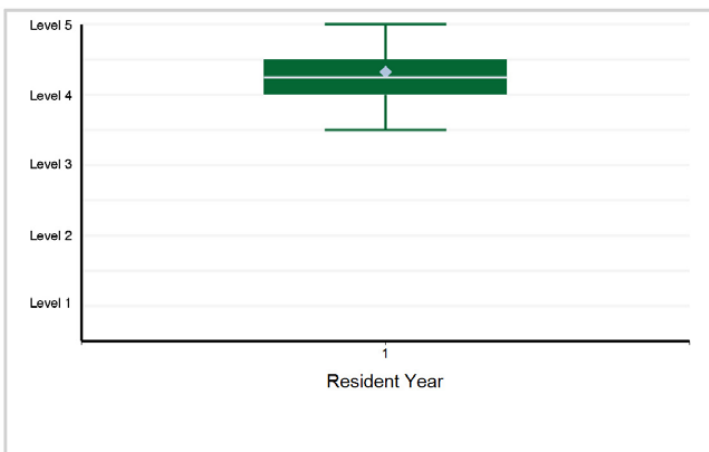

11. Systems-Based Practice - Systems-Based Practice 2: Quality Improvement

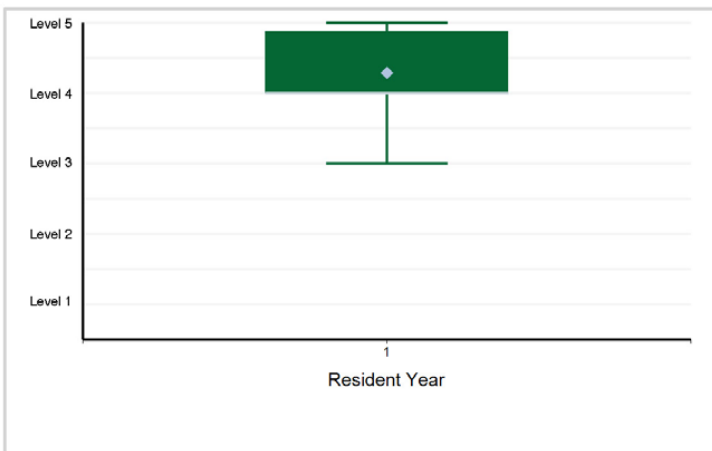

12. Systems-Based Practice - Systems-Based Practice 3: System Navigation for Patient-Centered Care

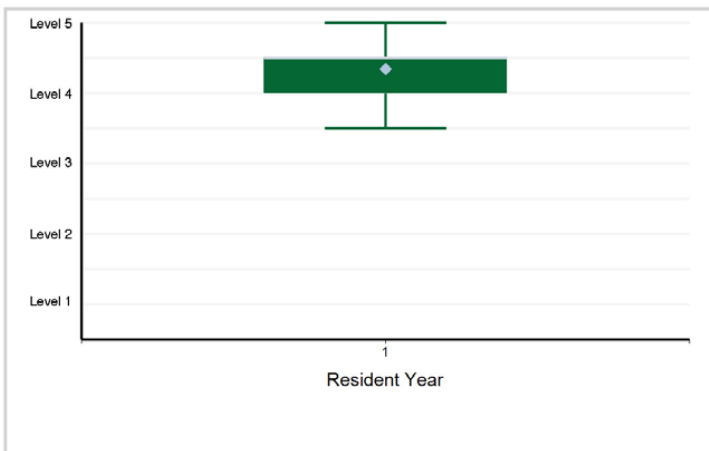

Specialty Box Plot Report - Milestone Evaluation by Resident Year: Year-End 2021-2022

SUBSPECIALTY: **Brain Injury Medicine (multidisciplinary, Physical Medicine and Rehabilitation)**

13. Systems-Based Practice - Systems-Based Practice 4: Physician Role in Health Care Systems

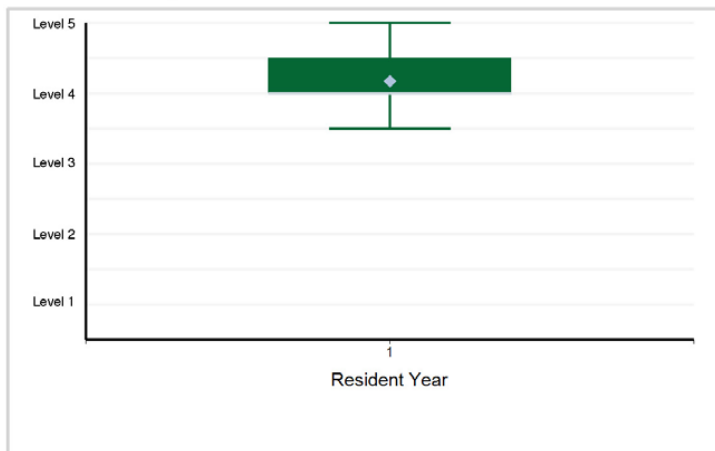

14. Practice-Based Learning and Improvement - Practice-Based Learning and Improvement 1: Evidence-Based and Informed Practice

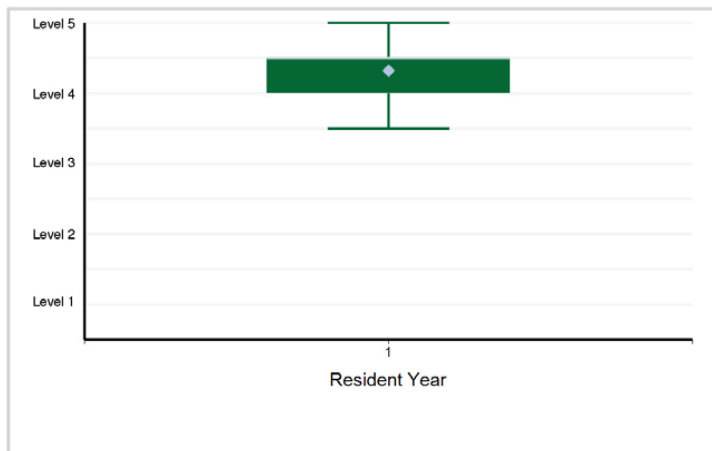

15. Practice-Based Learning and Improvement - Practice-Based Learning and Improvement 2: Reflective Practice and Commitment ...

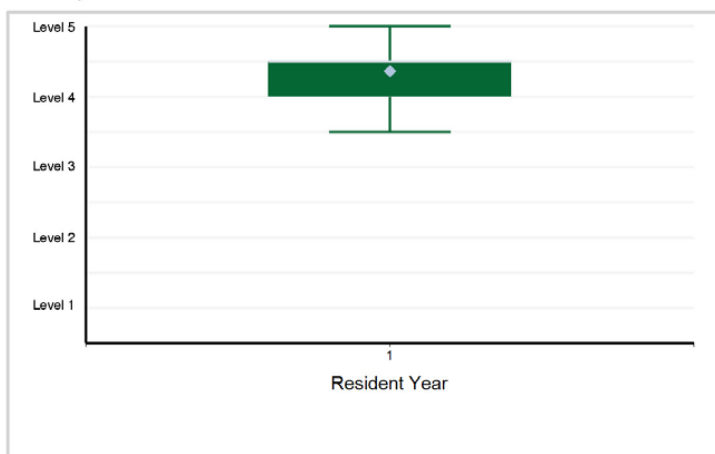

16. Professionalism - Professionalism 1: Ethics

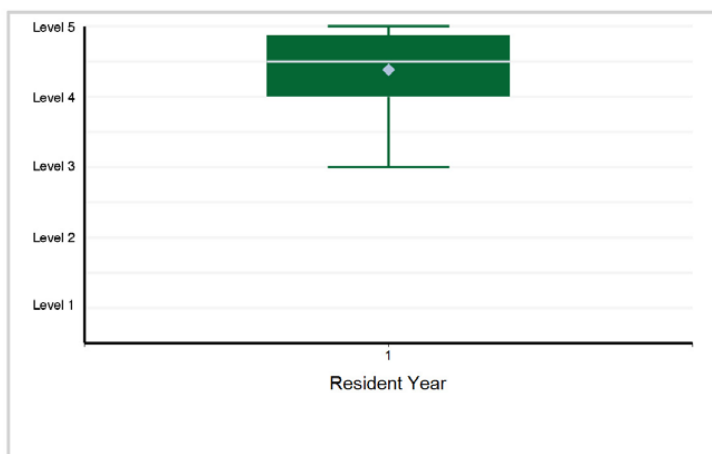

17. Professionalism - Professionalism 2: Professional Behaviors

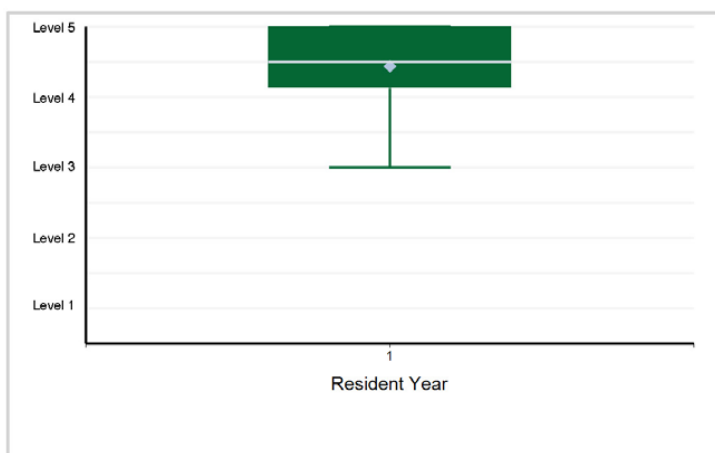

18. Professionalism - Professionalism 3: Accountability

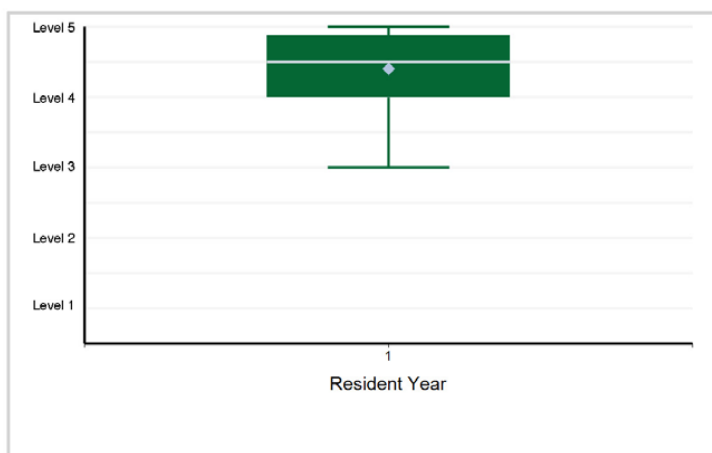

Specialty Box Plot Report - Milestone Evaluation by Resident Year: Year-End 2021-2022

SUBSPECIALTY: **Brain Injury Medicine (multidisciplinary, Physical Medicine and Rehabilitation)**

19. Professionalism - Professionalism 4: Patient Care Etiquette with Patients of All Abilities

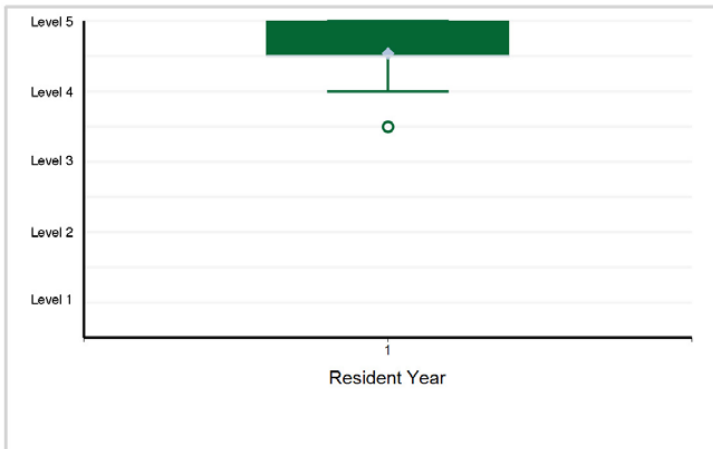

20. Professionalism - Professionalism 5: Fellow Well-Being and Help-Seeking

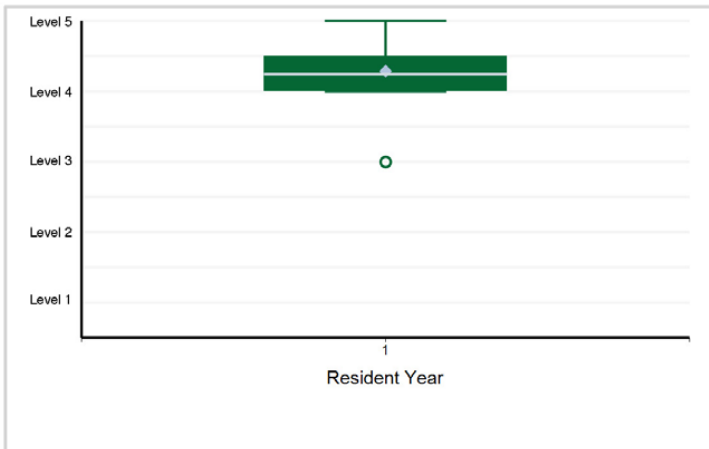

21. Interpersonal and Communication Skills - Interpersonal and Communication Skills 1: Patient- and Family-Centered Communication

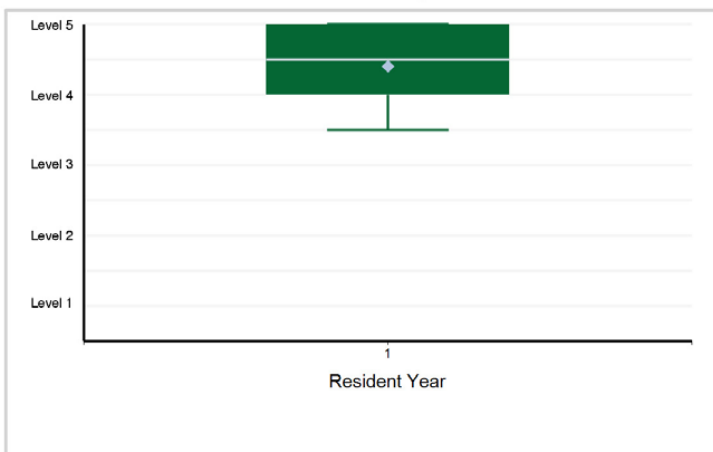

22. Interpersonal and Communication Skills - Interpersonal and Communication Skills 2: Interprofessional and Team Communication

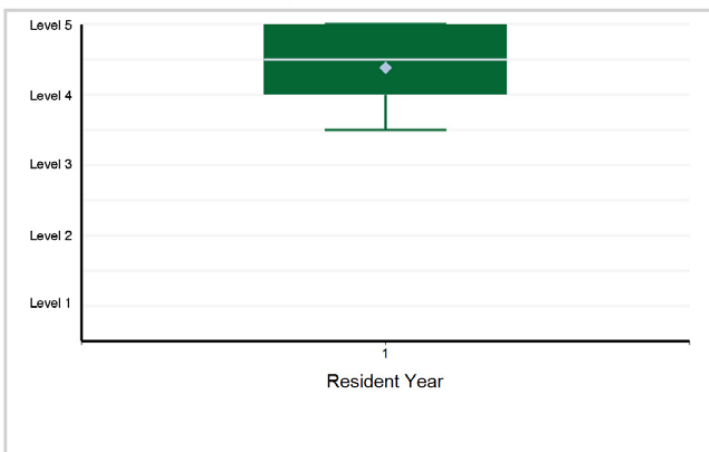

23. Interpersonal and Communication Skills - Interpersonal and Communication Skills 3: Communication within Health Care Systems

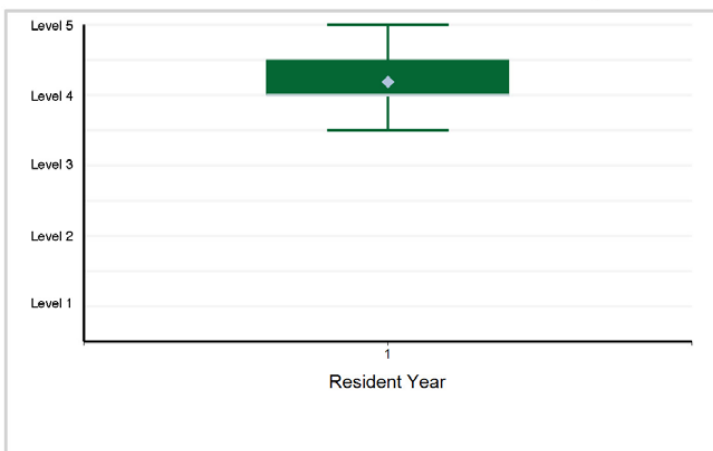

Specialty Box Plot Report - Milestone Evaluation by Resident Year: Year-End 2021-2022

TABLE 114: SUBSPECIALTY: **Pediatric Rehabilitation Medicine**

Resident Year	1	2	Total Residents
# of Residents	20	11	31

1. Patient Care - Patient Care 1: History for Pediatric Rehabilitation Patients

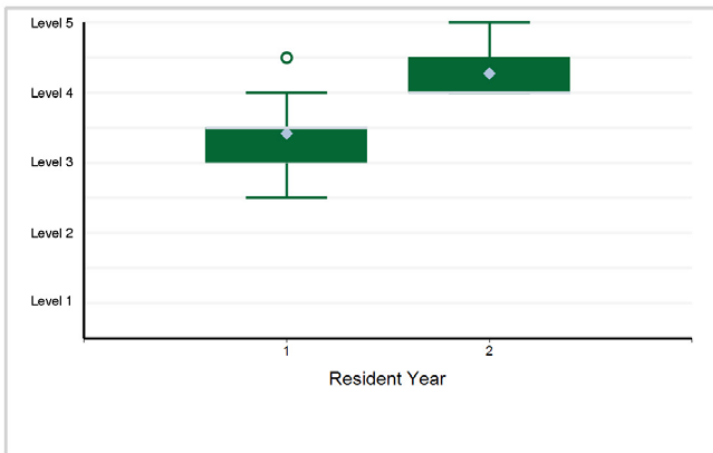

2. Patient Care - Patient Care 2: Physical Examination for Pediatric Rehabilitation Patients

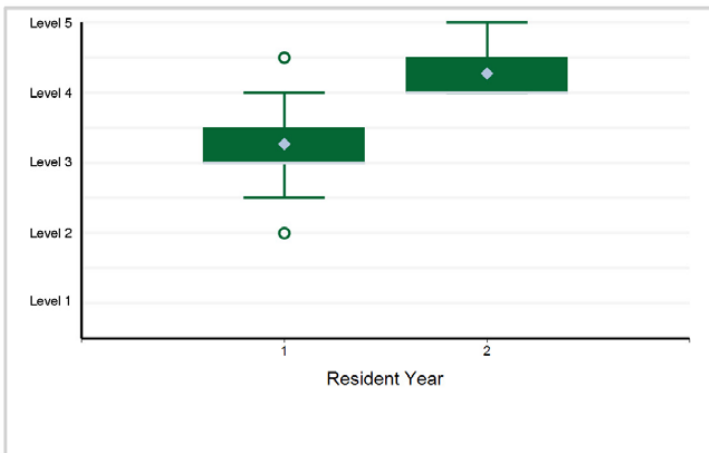

3. Patient Care - Patient Care 3: Differential Diagnosis of Pediatric Rehabilitation Medicine Patients

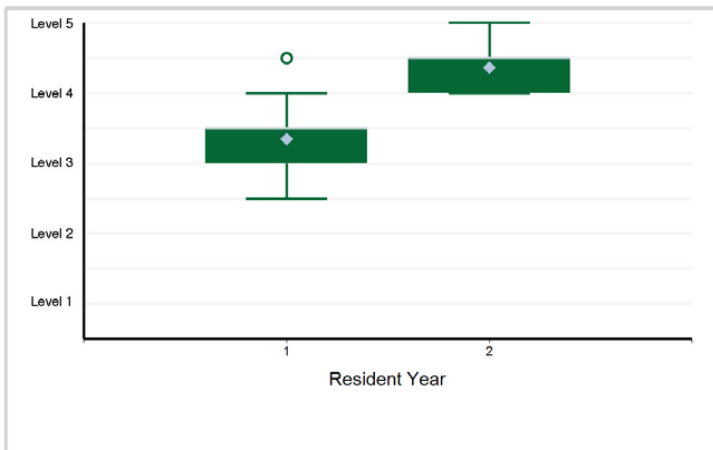

4. Patient Care - Patient Care 4: Diagnostic Evaluation of Pediatric Rehabilitation Medicine Patients

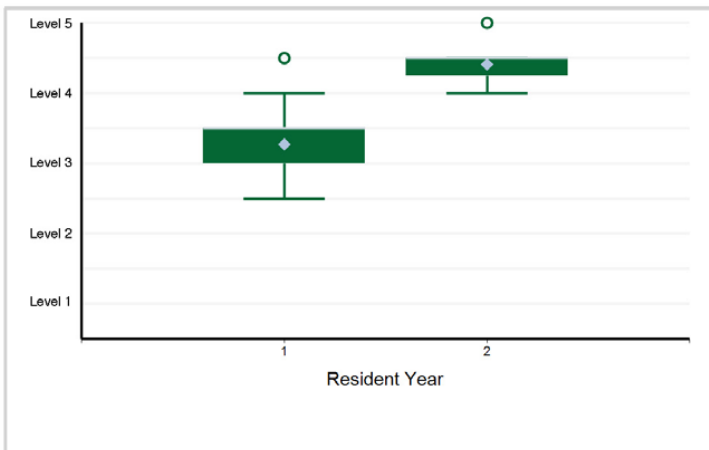

5. Patient Care - Patient Care 5: Medical Management of Pediatric Rehabilitation Medicine Patients

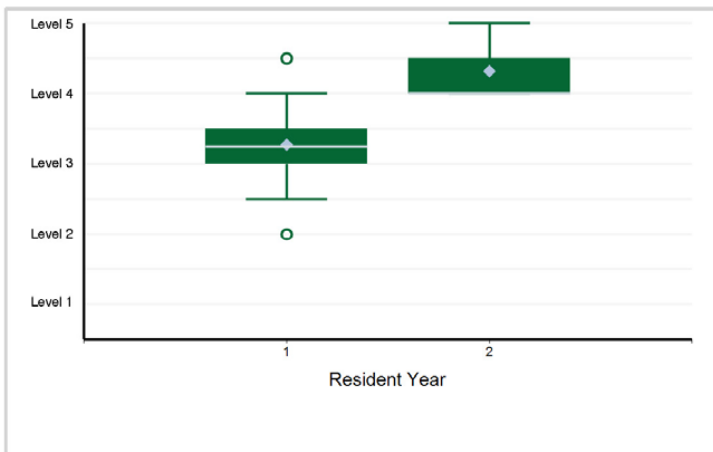

6. Patient Care - Patient Care 6: Rehabilitation/Functional Management of Pediatric Rehabilitation Medicine ...

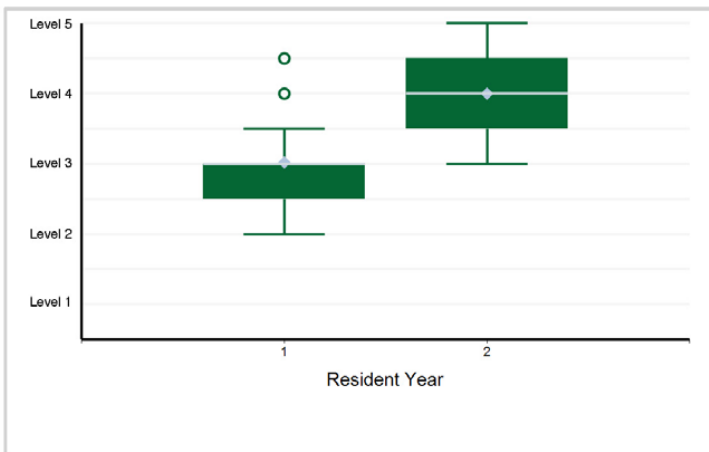

Specialty Box Plot Report - Milestone Evaluation by Resident Year: Year-End 2021-2022

SUBSPECIALTY: Pediatric Rehabilitation Medicine

7. Patient Care - Patient Care 7: Rehabilitation/Functional Management of Pediatric Rehabilitation Medicine ...

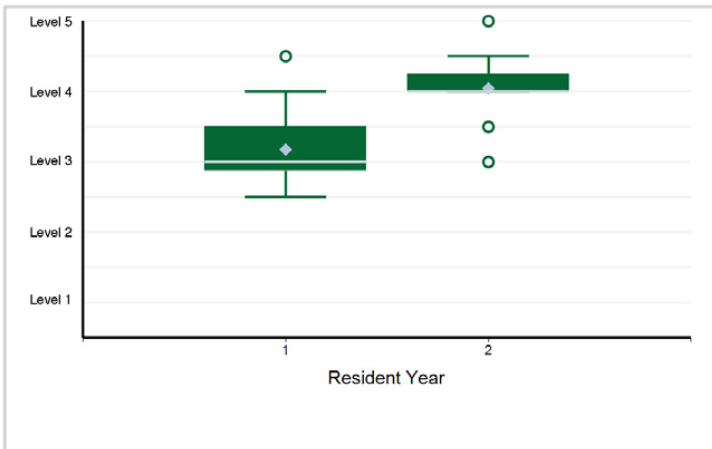

8. Patient Care - Patient Care 8: Procedural Skills in Pediatric Rehabilitation Medicine

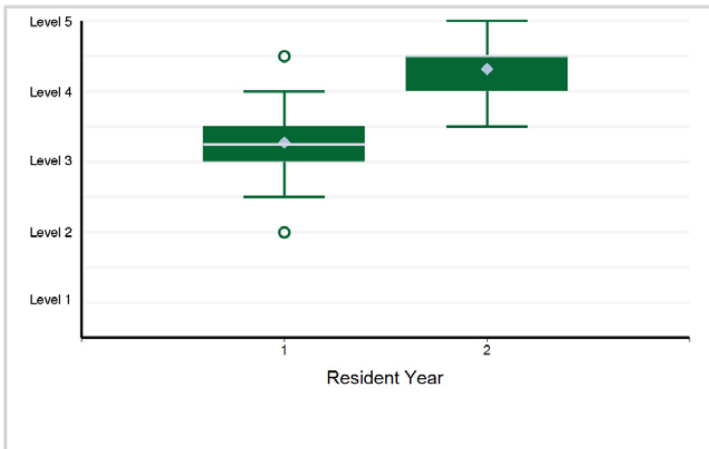

9. Medical Knowledge - Medical Knowledge 1: Physiologic Knowledge

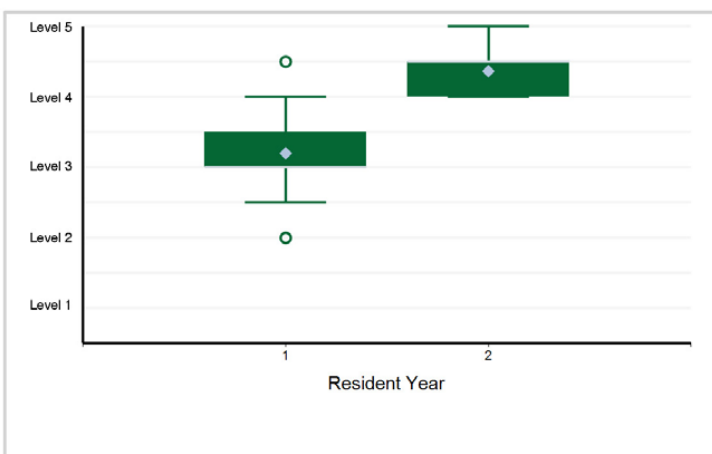

10. Medical Knowledge - Medical Knowledge 2: Growth and Development

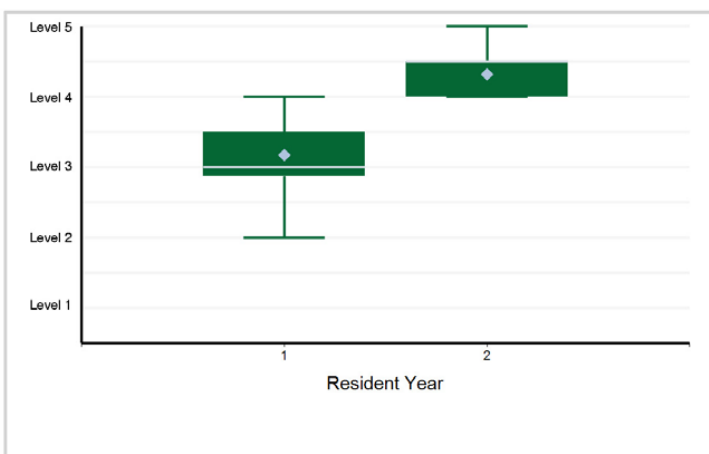

11. Systems-Based Practice - Systems-Based Practice 1: Patient Safety in Pediatric Rehabilitation

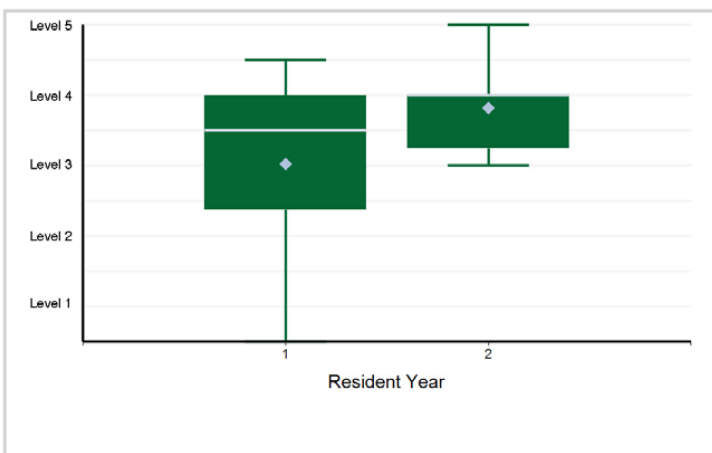

12. Systems-Based Practice - Systems-Based Practice 2: Quality Improvement in Pediatric Rehabilitation

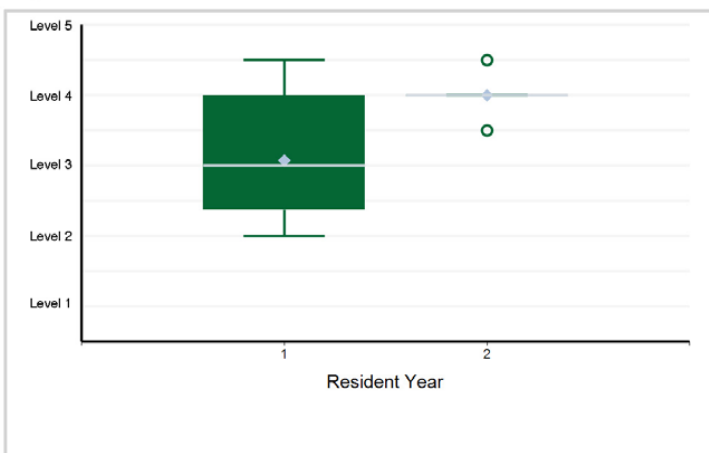

Specialty Box Plot Report - Milestone Evaluation by Resident Year: Year-End 2021-2022

SUBSPECIALTY: Pediatric Rehabilitation Medicine

13. Systems-Based Practice - Systems-Based Practice 3: System Navigation for Patient-Centered Care

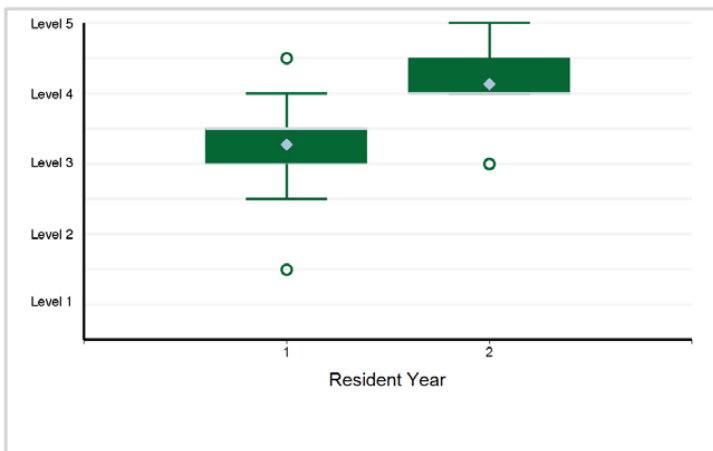

14. Systems-Based Practice - Systems-Based Practice 4: Physician Role in Health Care Systems

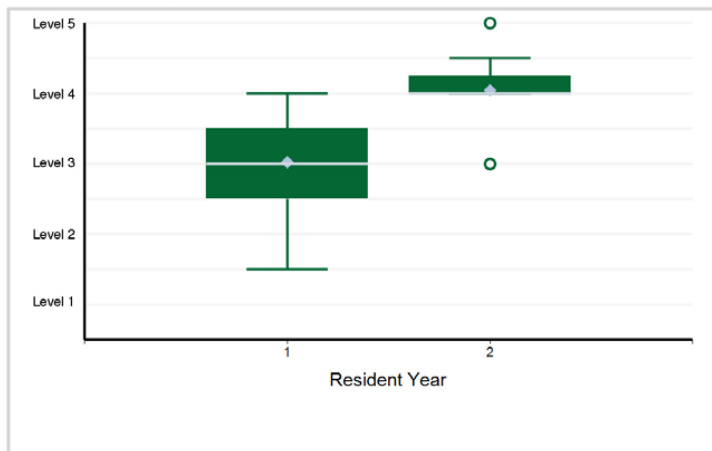

15. Practice-Based Learning and Improvement - Practice-Based Learning and Improvement 1: Evidence-Based and Informed Practice

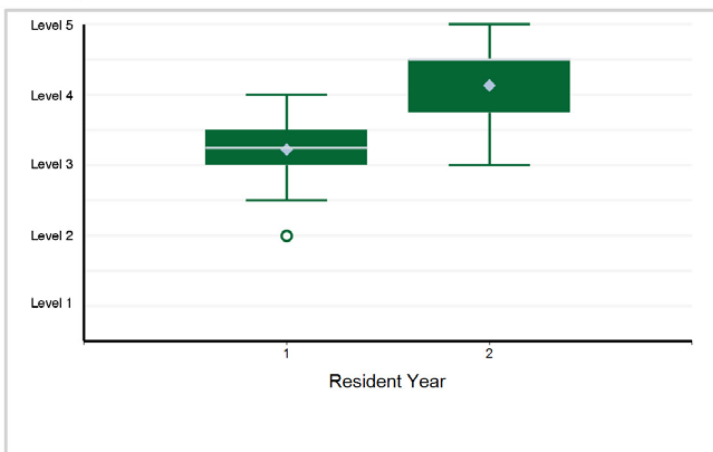

16. Practice-Based Learning and Improvement - Practice-Based Learning and Improvement 2: Reflective Practice and Commitment ...

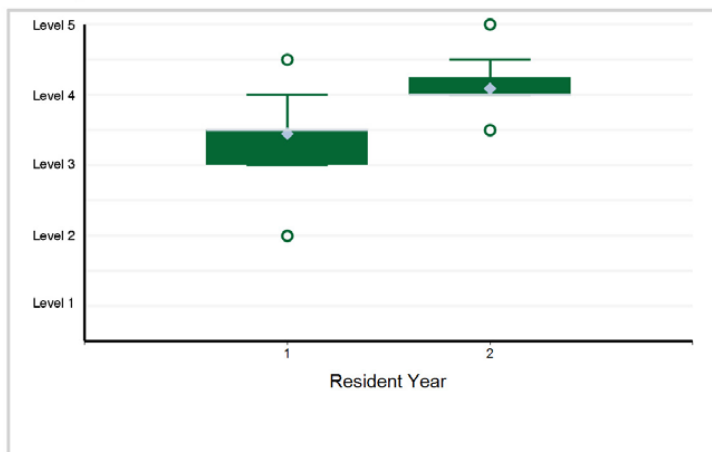

17. Professionalism - Professionalism 1: Ethical Practice

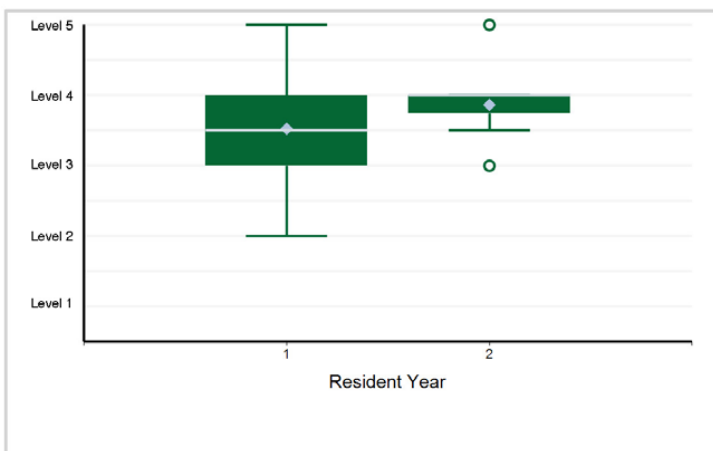

18. Professionalism - Professionalism 2: Professional Behaviors

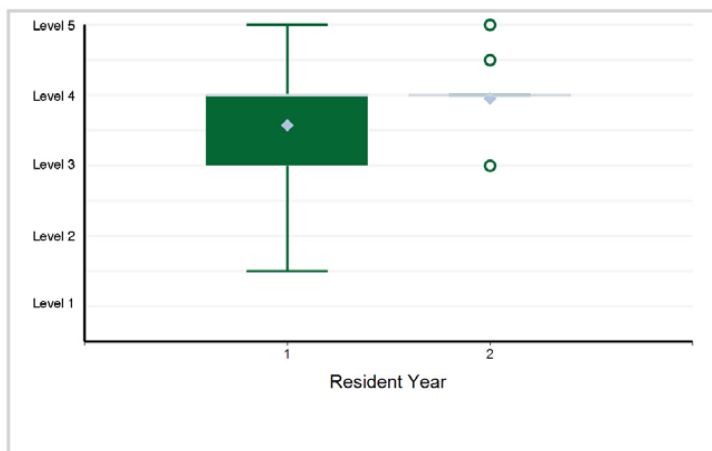

Specialty Box Plot Report - Milestone Evaluation by Resident Year: Year-End 2021-2022

SUBSPECIALTY: Pediatric Rehabilitation Medicine

19. Professionalism - Professionalism 3: Accountability

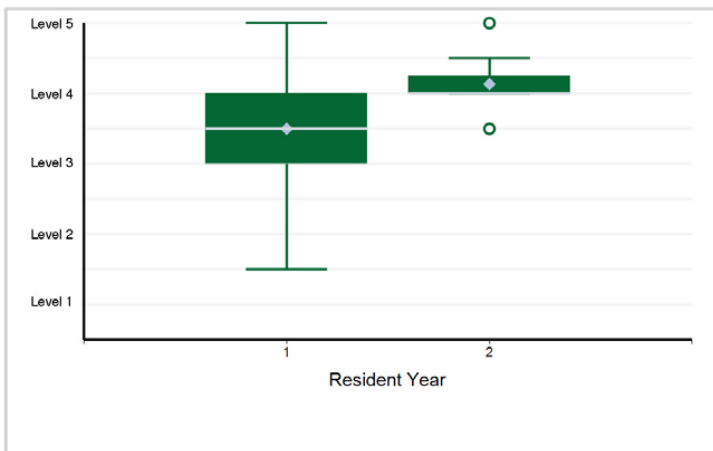

20. Professionalism - Professionalism 4: Patient Care Etiquette with Patients of All Abilities

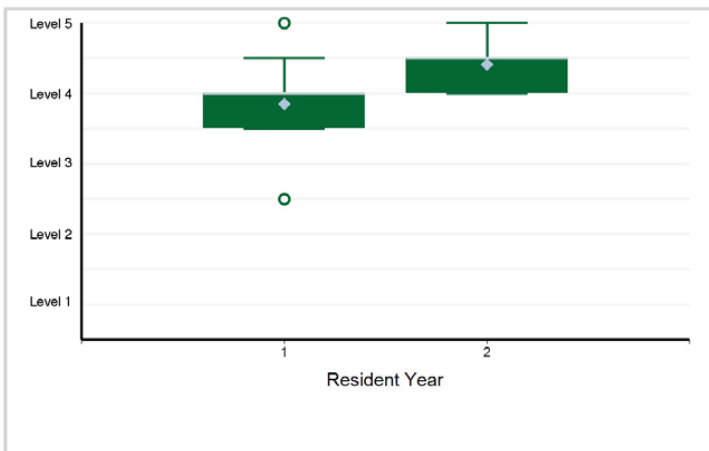

21. Professionalism - Professionalism 5: Well-Being and Help-Seeking

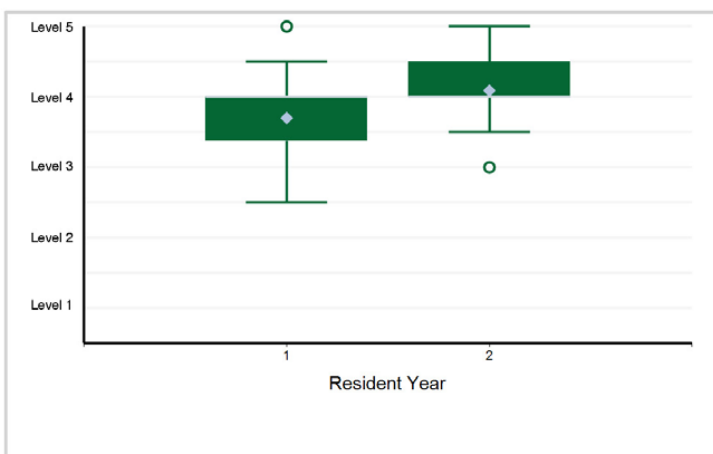

22. Interpersonal and Communication Skills - Interpersonal and Communication Skills 1: Patient- and Family-Centered Communication

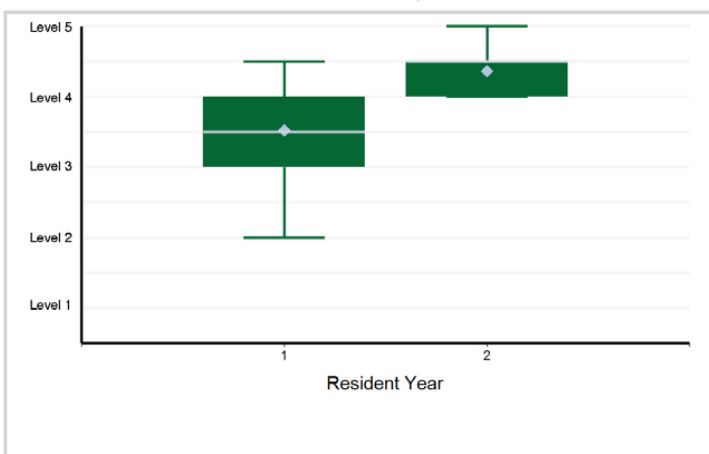

23. Interpersonal and Communication Skills - Interpersonal and Communication Skills 2: Interprofessional and Team Communication

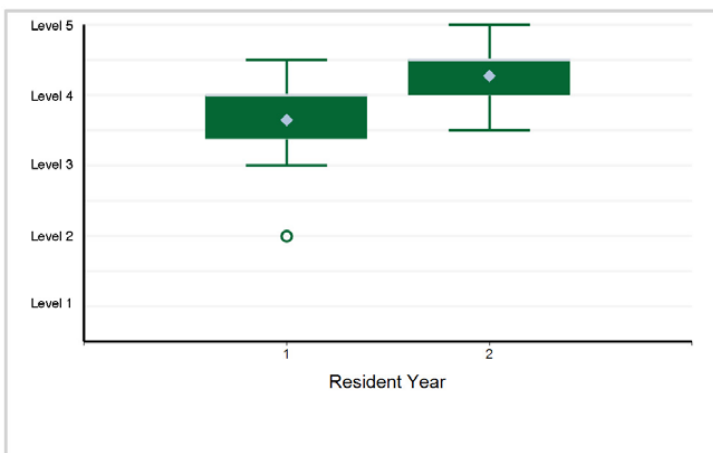

24. Interpersonal and Communication Skills - Interpersonal and Communication Skills 3: Communication within Health Care Systems

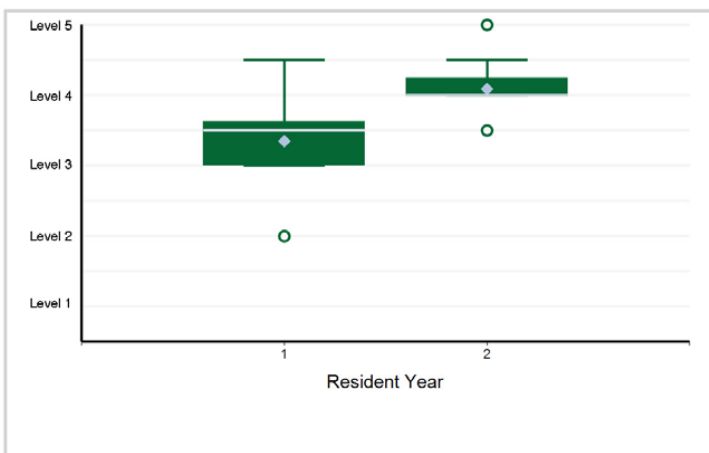

Specialty Box Plot Report - Milestone Evaluation by Resident Year: Year-End 2021-2022

TABLE 115: SUBSPECIALTY: **Spinal Cord Injury Medicine**

Resident Year	1	Total Residents
# of Residents	23	23

1. Patient Care - Patient Care 1:History of Individuals with Spinal Cord Disorders

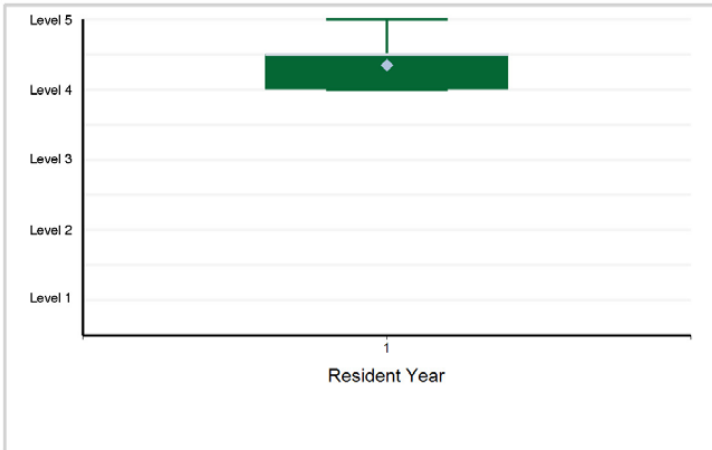

2. Patient Care - Patient Care 2: Physical Examination of Individuals with Spinal Cord Disorders

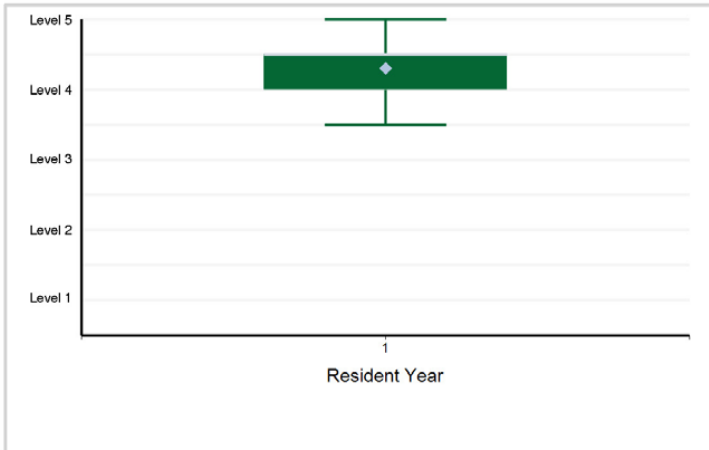

3. Patient Care - Patient Care 3: Medical/Surgical Management of Individuals with Spinal Cord Disorders

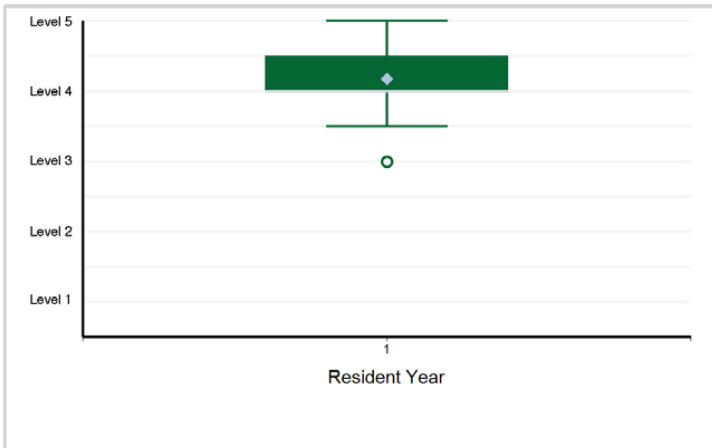

4. Patient Care - Patient Care 4: Assistive Technologies (e.g., Prosthetics and Orthotics, Adaptive Equipment, ...)

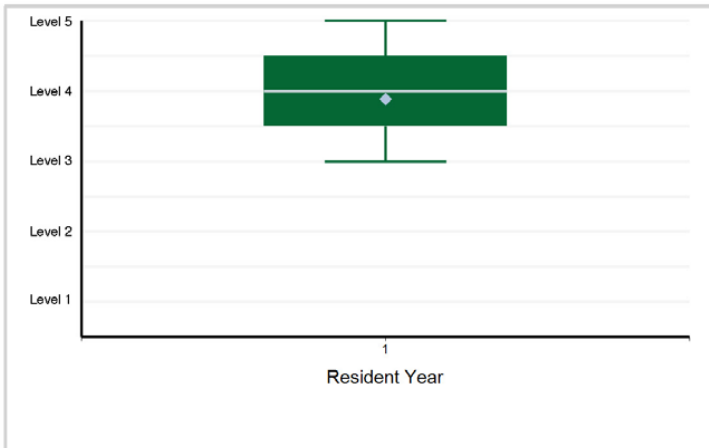

5. Patient Care - Patient Care 5: Rehabilitation Interventions

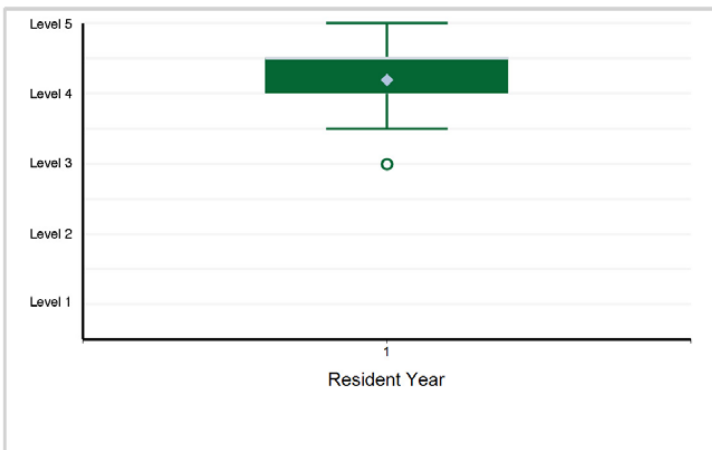

6. Medical Knowledge - Medical Knowledge 1: Clinical Reasoning

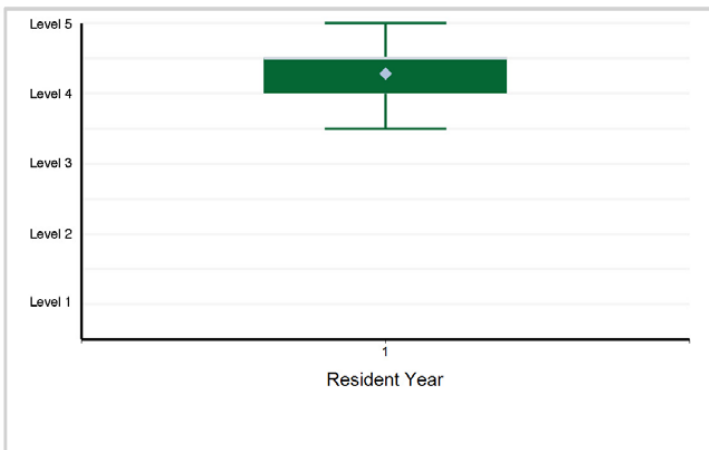

Specialty Box Plot Report - Milestone Evaluation by Resident Year: Year-End 2021-2022

SUBSPECIALTY: Spinal Cord Injury Medicine

7. Medical Knowledge - Medical Knowledge 2: Traumatic and Non-Traumatic Spinal Cord Disorders This includes: ...

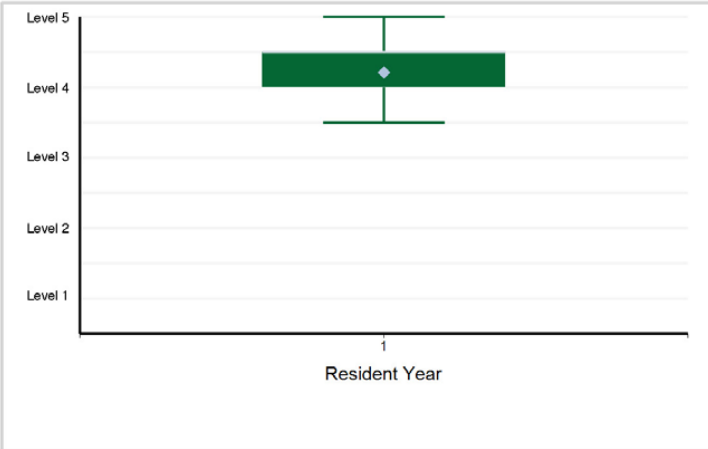

8. Medical Knowledge - Medical Knowledge 3: Functional Outcomes and Interventions

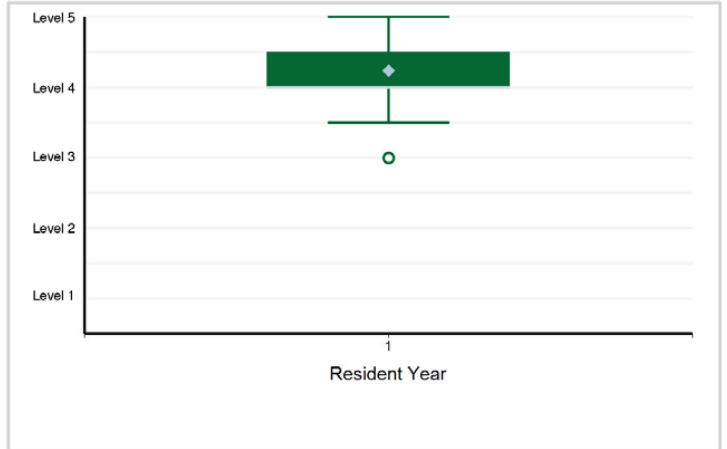

9. Systems-Based Practice - Systems-Based Practice 1: Patient Safety

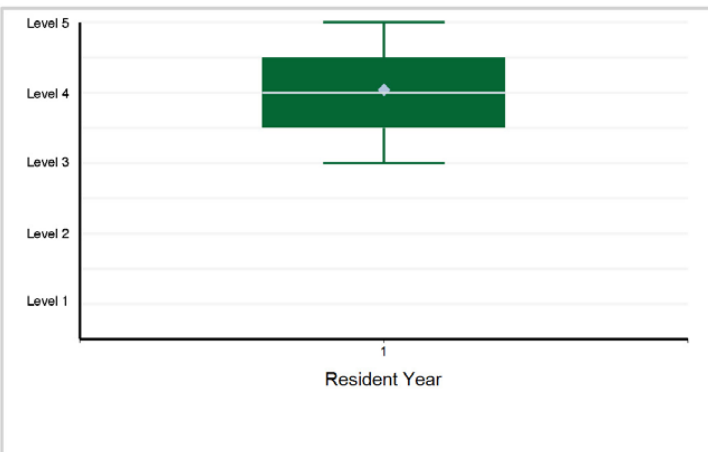

10. Systems-Based Practice - Systems-Based Practice 2: Quality Improvement

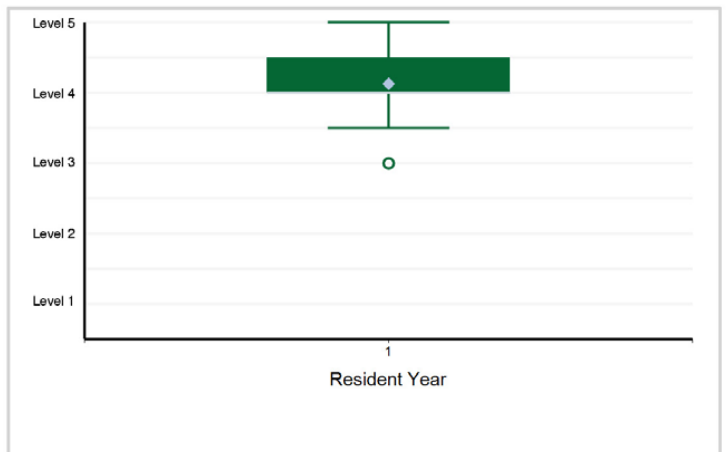

11. Systems-Based Practice - Systems-Based Practice 3: System Navigation for Patient-Centered Care

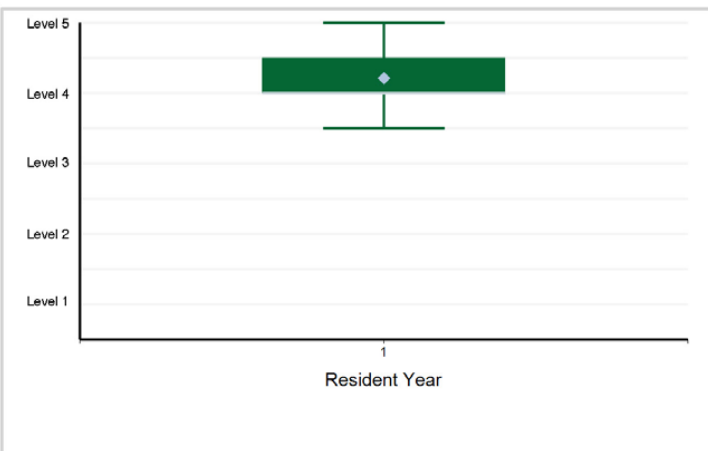

12. Systems-Based Practice - Systems-Based Practice 4: Physician Role in Health Care Systems

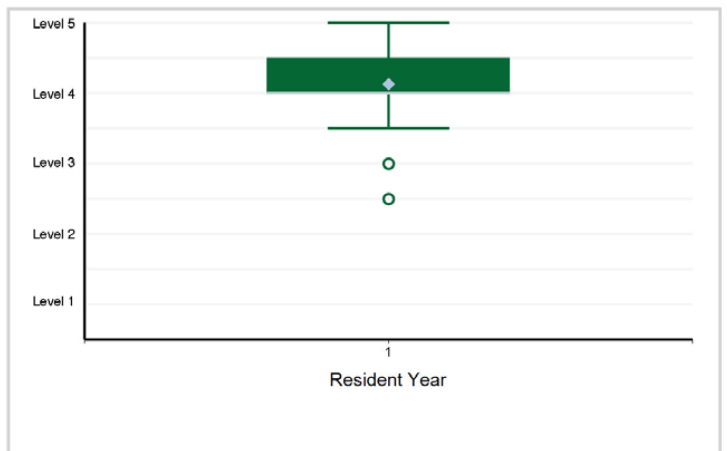

Specialty Box Plot Report - Milestone Evaluation by Resident Year: Year-End 2021-2022

SUBSPECIALTY: Spinal Cord Injury Medicine

13. Practice-Based Learning and Improvement - Practice-Based Learning and Improvement 1: Evidence-Based and Informed Practice

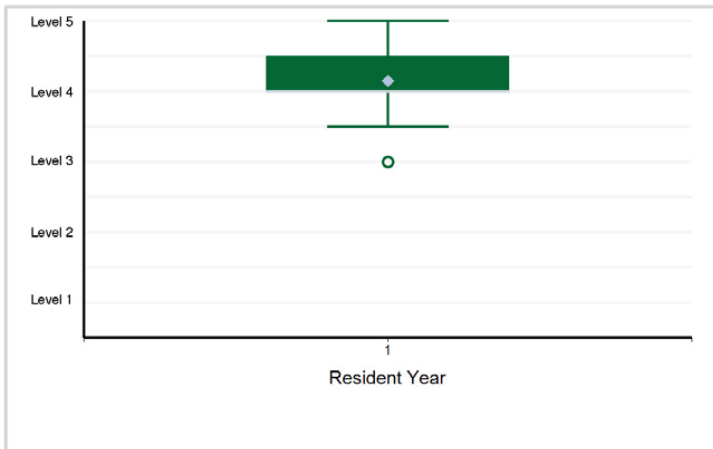

14. Practice-Based Learning and Improvement - Practice-Based Learning and Improvement 2: Reflective Practice and Commitment ...

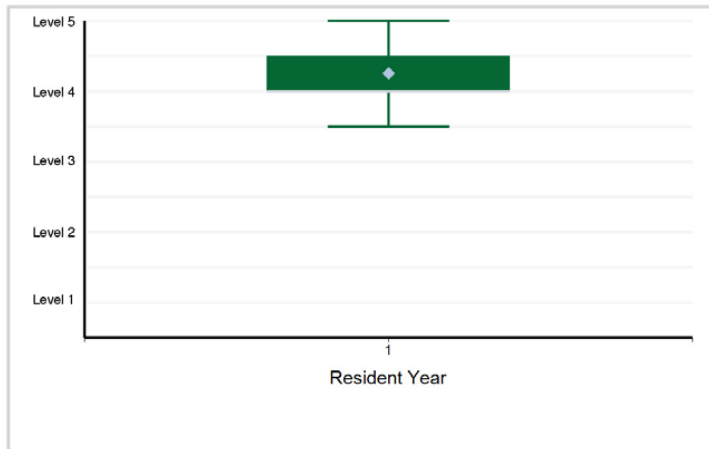

15. Professionalism - Professionalism 1: Ethical Practice

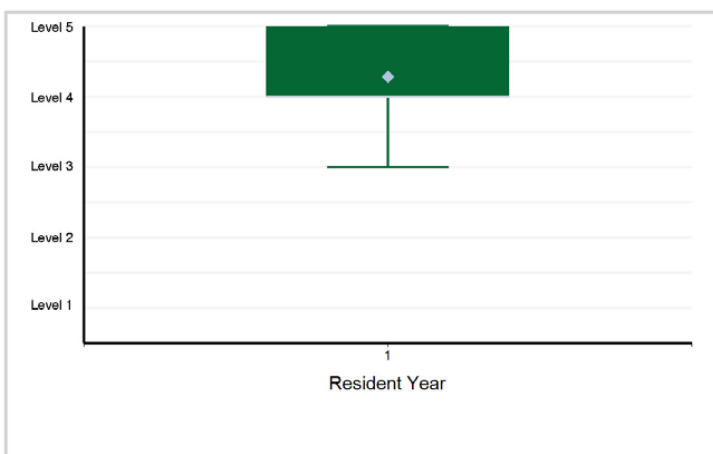

16. Professionalism - Professionalism 2: Professional Behaviors

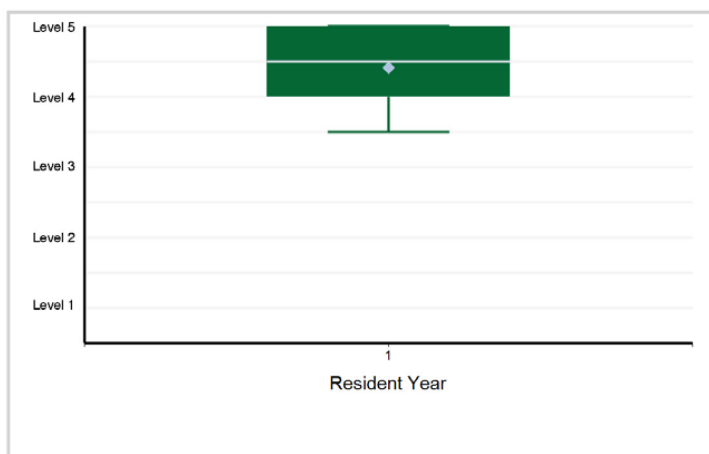

17. Professionalism - Professionalism 3: Accountability

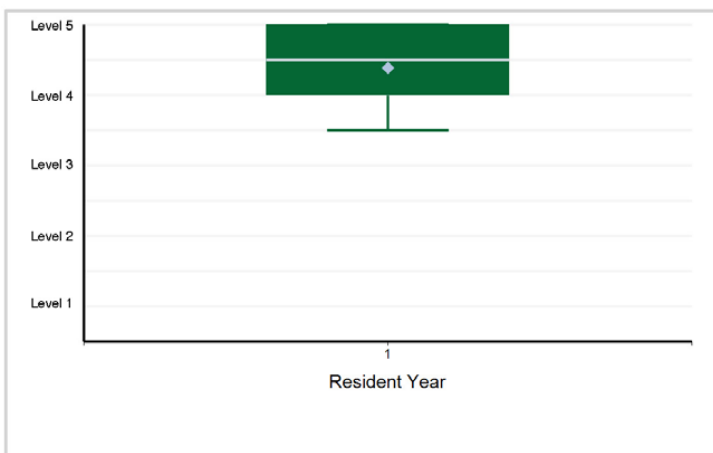

18. Professionalism - Professionalism 4: Patient Care Etiquette with Patients of All Abilities

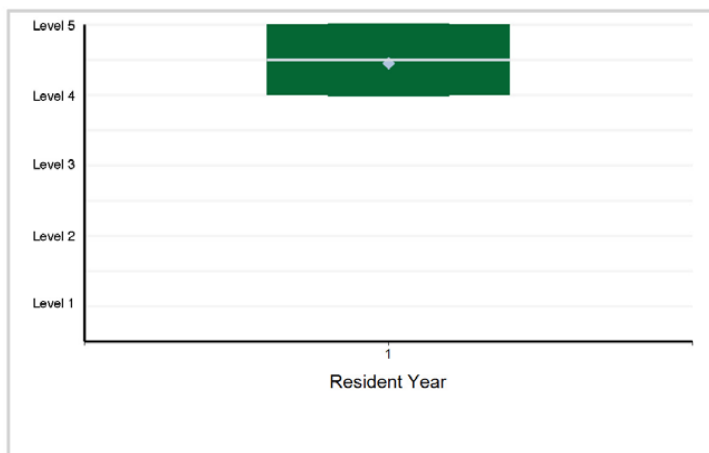

Specialty Box Plot Report - Milestone Evaluation by Resident Year: Year-End 2021-2022

SUBSPECIALTY: Spinal Cord Injury Medicine

19. Interpersonal and Communication Skills - Interpersonal and Communication Skills 1: Patient- and Family-Centered Communication

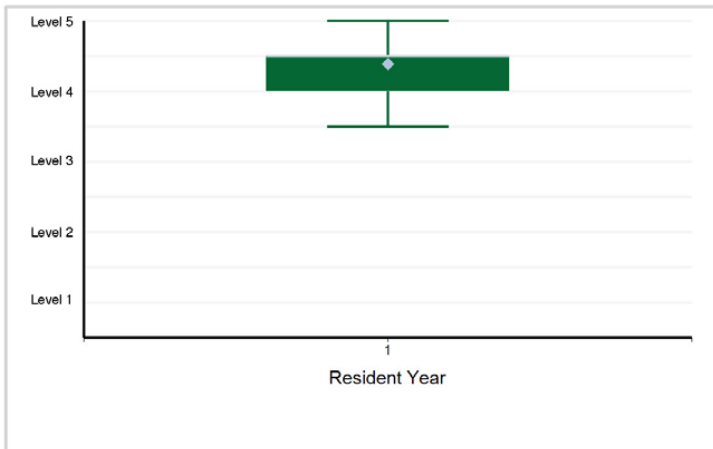

20. Interpersonal and Communication Skills - Interpersonal and Communication Skills 2: Interprofessional and Team Communication

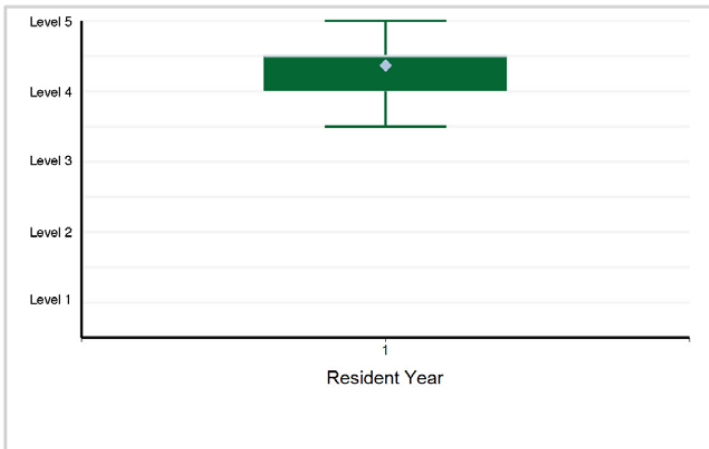

21. Interpersonal and Communication Skills - Interpersonal and Communication Skills 3: Communication within Health Care Systems

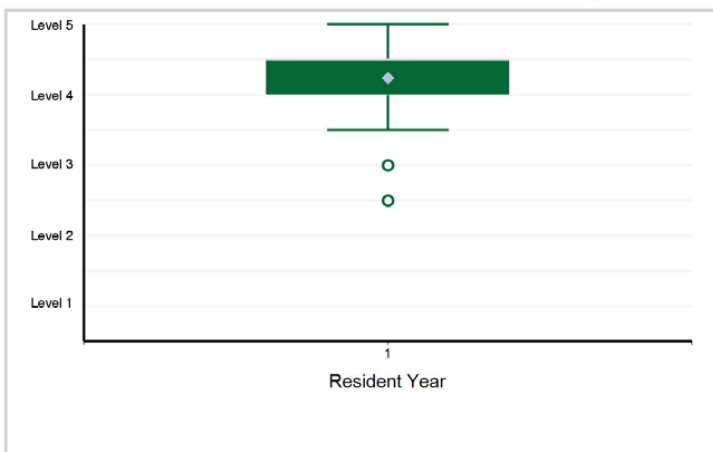

22. Interpersonal and Communication Skills - Interpersonal and Communication Skills 4: Complex Communication ...

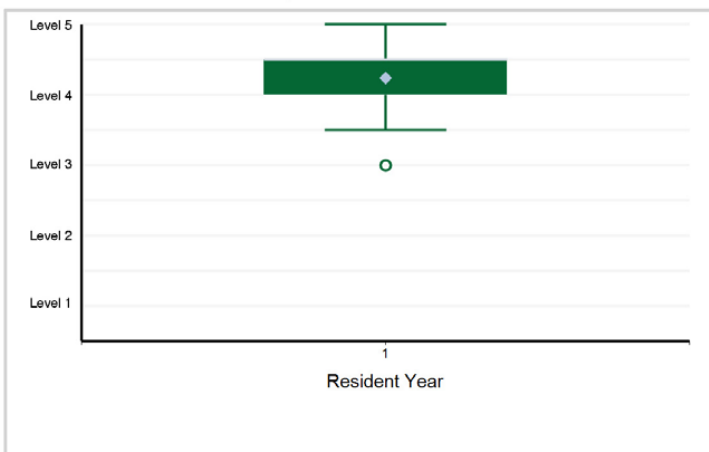

23. Professionalism - Professionalism 5: Fellow Well-Being and Help-Seeking

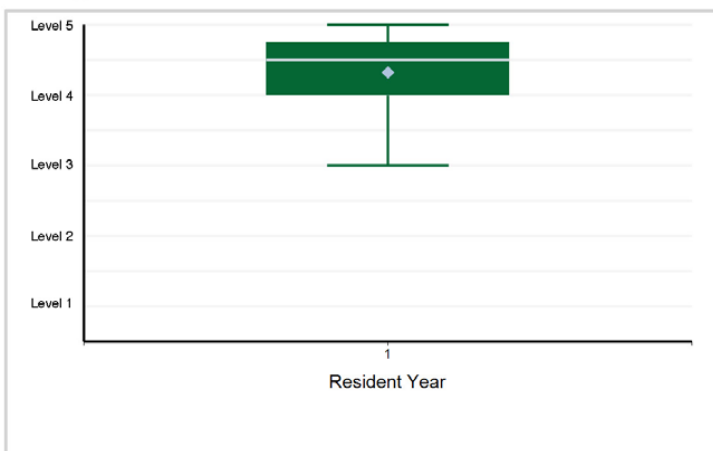

Specialty Box Plot Report - Milestone Evaluation by Resident Year: Year-End 2021-2022

TABLE 116: SUBSPECIALTY: **Sports Medicine (multidisciplinary, Physical Medicine and Rehabilitation)**

Resident Year	1	Total Residents*
# of Residents	40	40

*Note: There are 3 residents with an incomplete milestone evaluation that are excluded from the box plots below.

1. Patient Care - History and Physical Examination: Medical and Musculoskeletal — Patient Care 1

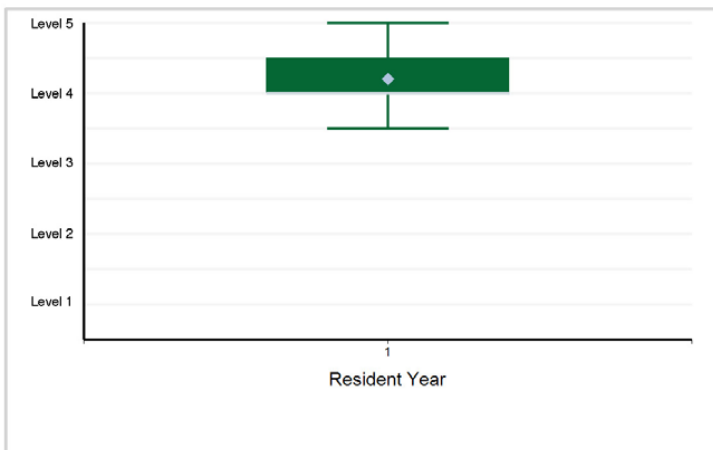

2. Patient Care - Medical Management: Differential Diagnosis, Diagnostic Testing, Interpretation of Data ...

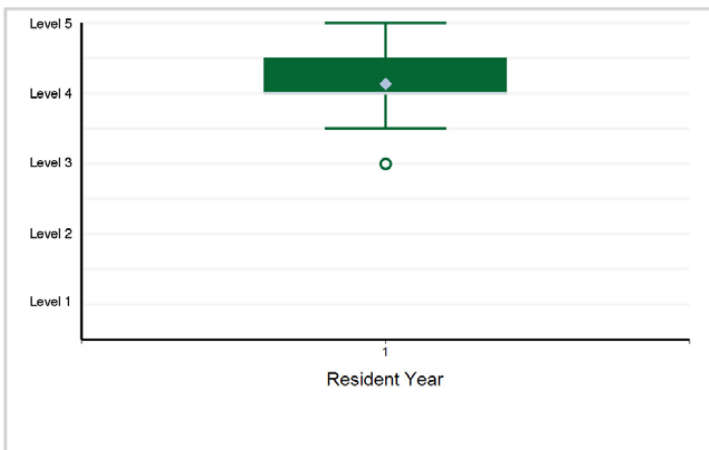

3. Patient Care - Team Coverage and Athletic Care: Coverage of Sporting Events, Pre-participation Physical ...

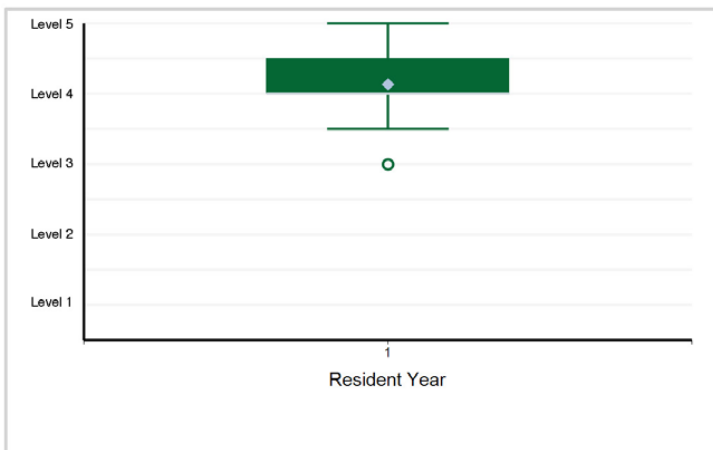

4. Medical Knowledge - Science of Sports Medicine, including Anatomy, Physiology, Cellular Biology, Epidemiology, ...

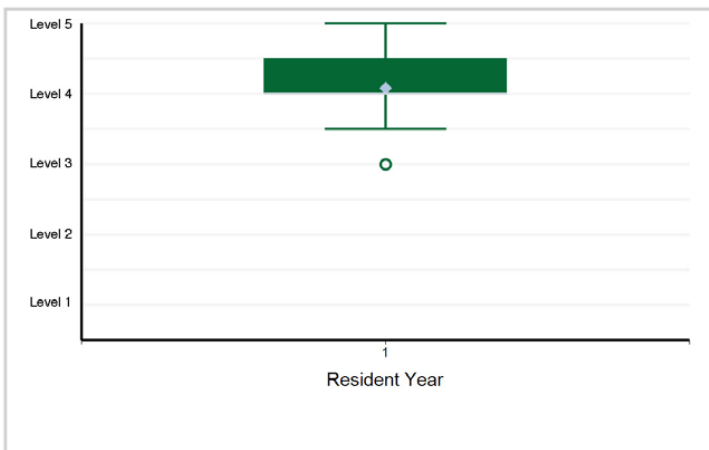

5. Medical Knowledge - Medical Issues in Sports Medicine — Medical Knowledge 2

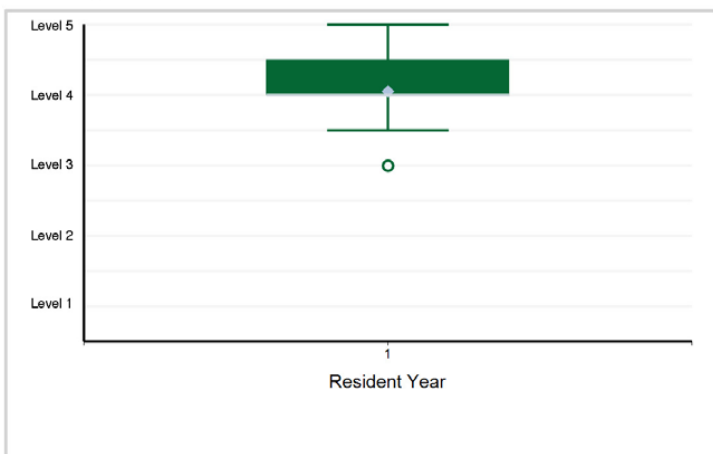

6. Medical Knowledge - Musculoskeletal Issues in Sports Medicine — Medical Knowledge 3

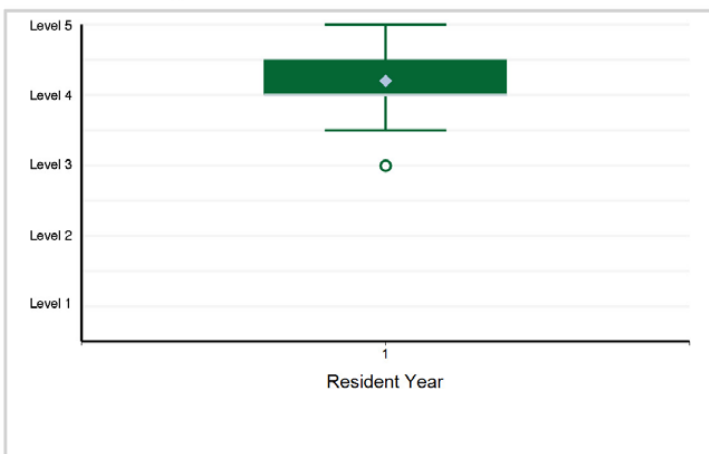

Specialty Box Plot Report - Milestone Evaluation by Resident Year: Year-End 2021-2022

SUBSPECIALTY: **Sports Medicine (multidisciplinary, Physical Medicine and Rehabilitation)**

7. Systems-Based Practice - Working with Interprofessional Teams (consultants, certified athletic trainers ...)

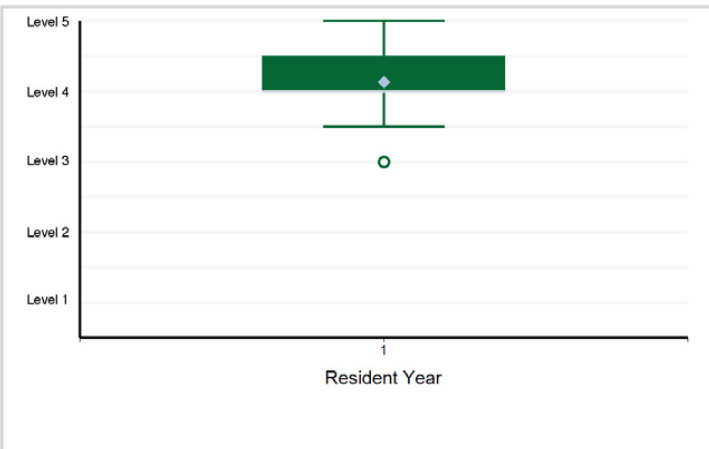

8. Systems-Based Practice - Systems Thinking — Systems-Based Practice 2

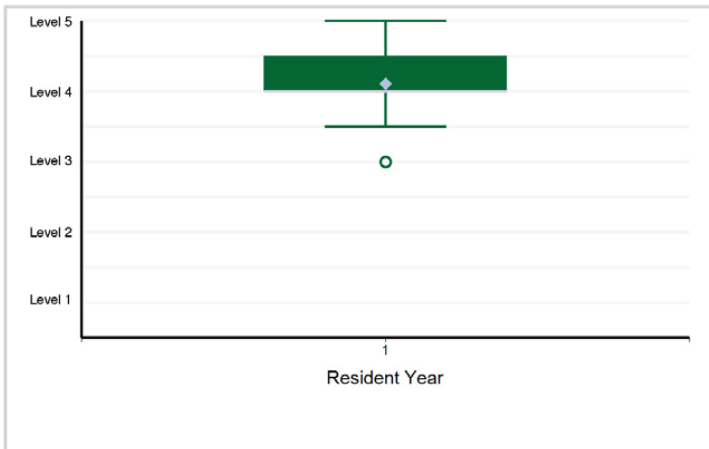

9. Practice-Based Learning and Improvement - Self-directed Learning — Practice-Based Learning and Improvement ...

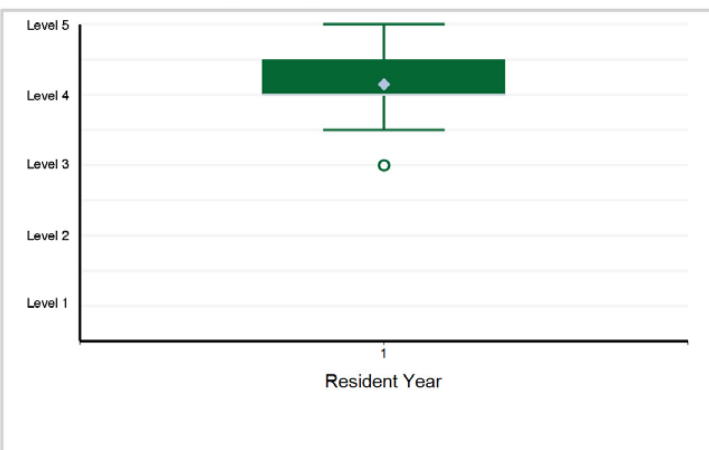

10. Practice-Based Learning and Improvement - Locate, Appraise, and Assimilate Evidence from Scientific ...

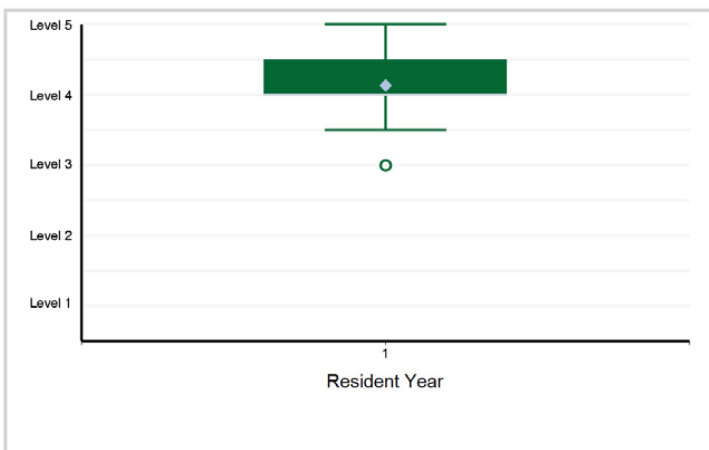

11. Professionalism - Compassion, Integrity, Accountability, and Respect for Self and Others — Professionalism 1

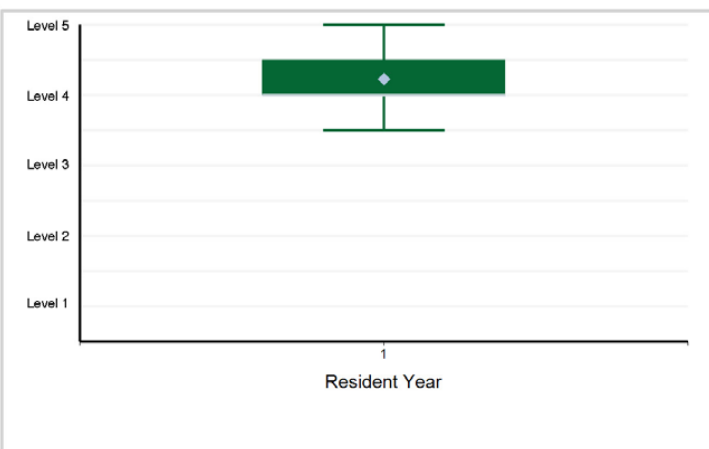

12. Professionalism - Knowledge about and Adherence to the Ethical Principles Relevant to the Practice of Sports Medicine — ...

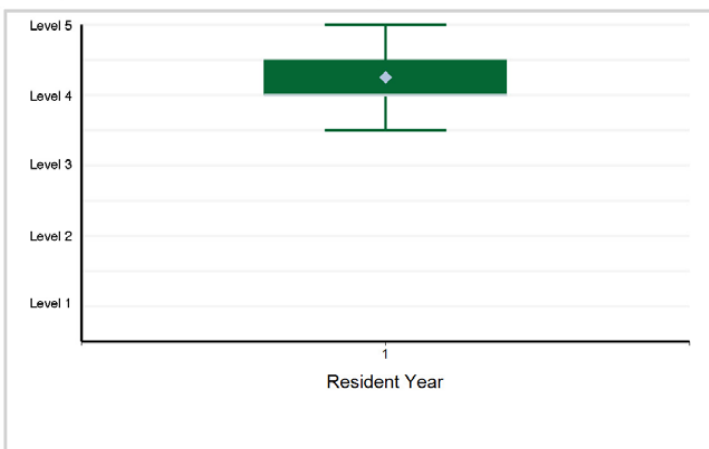

Specialty Box Plot Report - Milestone Evaluation by Resident Year: Year-End 2021-2022

SUBSPECIALTY: **Sports Medicine (multidisciplinary, Physical Medicine and Rehabilitation)**

13. Interpersonal and Communication Skills - Relationship Development, Teamwork, and Managing Conflict — ...

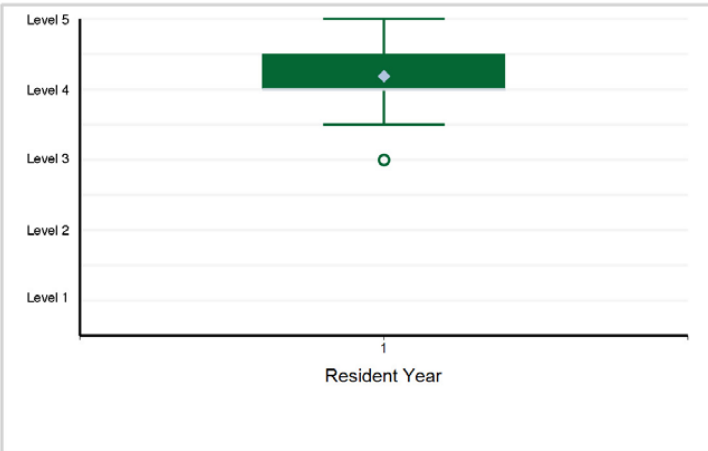

14. Interpersonal and Communication Skills - Information Sharing, Gathering, and Technology — Interpersonal ...

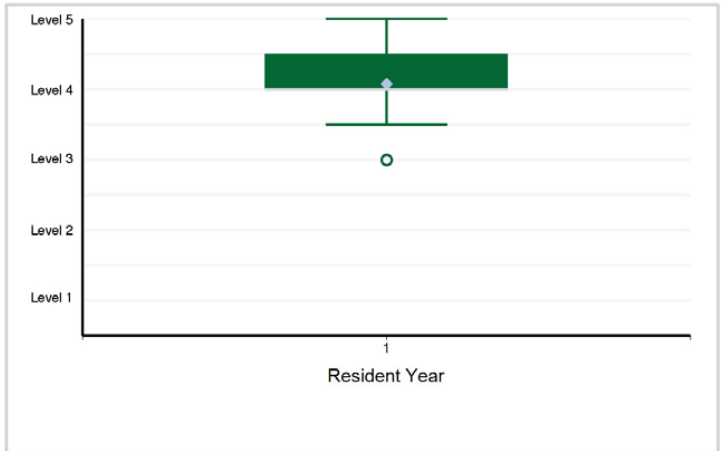

Specialty Box Plot Report - Milestone Evaluation by Resident Year: Year-End 2021-2022

TABLE 117: SPECIALTY: **Plastic Surgery - Independent**

Resident Year	1	2	3	Total Residents
# of Residents	68	66	69	203

1. Patient Care - Surgical Care — Patient Care

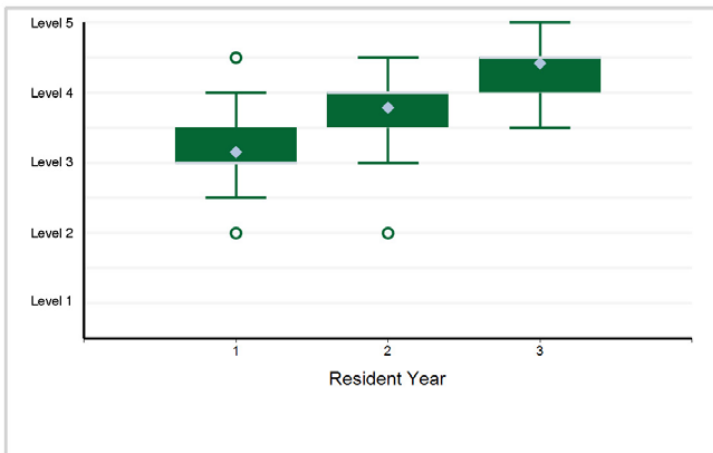

2. Medical Knowledge - Surgical Care — Medical Knowledge

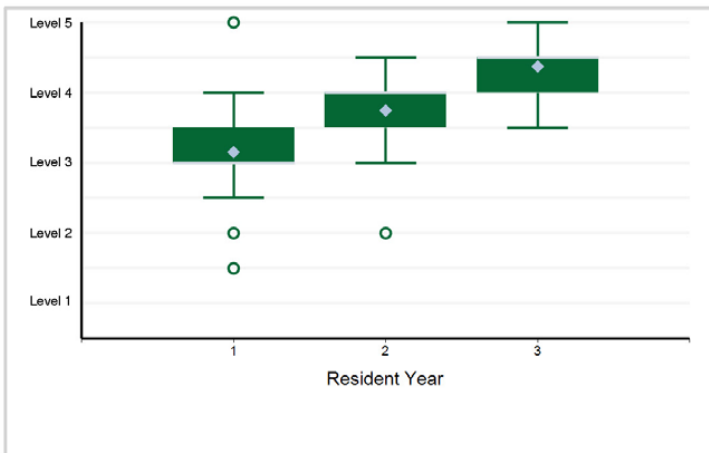

3. Patient Care - Wound Care — Patient Care

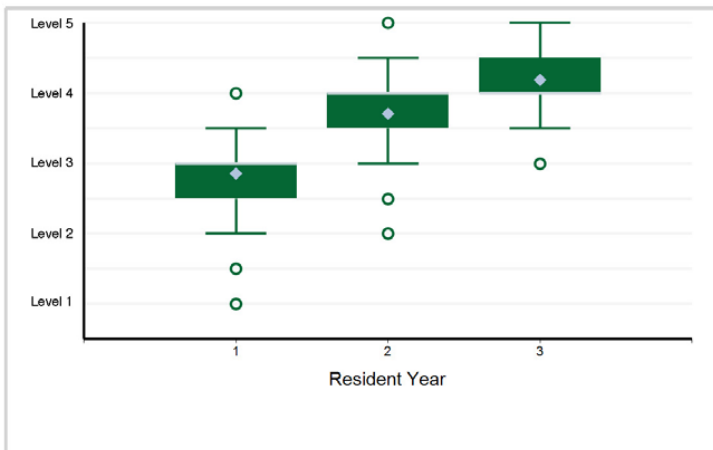

4. Medical Knowledge - Wound Care — Medical Knowledge

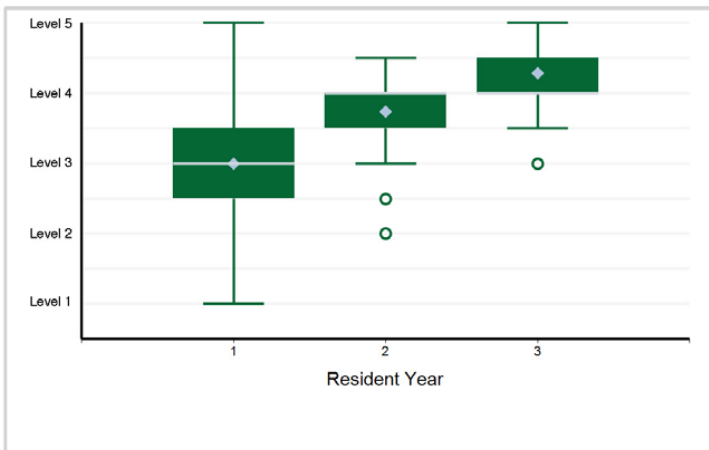

5. Patient Care - Tissue Transfer — Patient Care

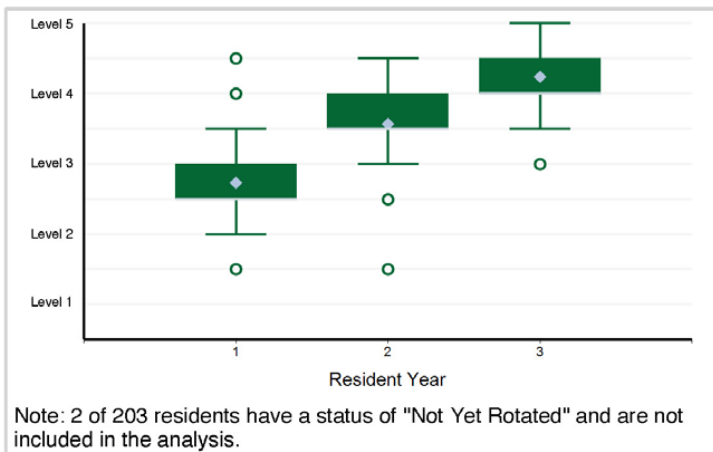

6. Medical Knowledge - Tissue Transfer — Medical Knowledge

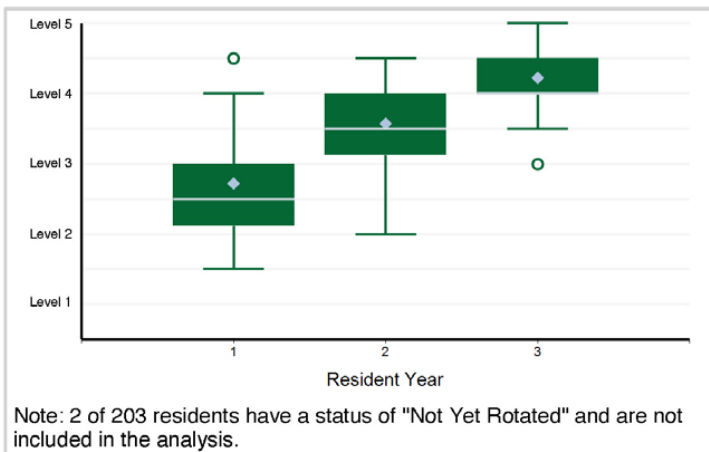

Note: 2 of 203 residents have a status of "Not Yet Rotated" and are not included in the analysis.

Note: 2 of 203 residents have a status of "Not Yet Rotated" and are not included in the analysis.

Specialty Box Plot Report - Milestone Evaluation by Resident Year: Year-End 2021-2022

SPECIALTY: Plastic Surgery - Independent

7. Patient Care - Congenital Anomalies — Patient Care

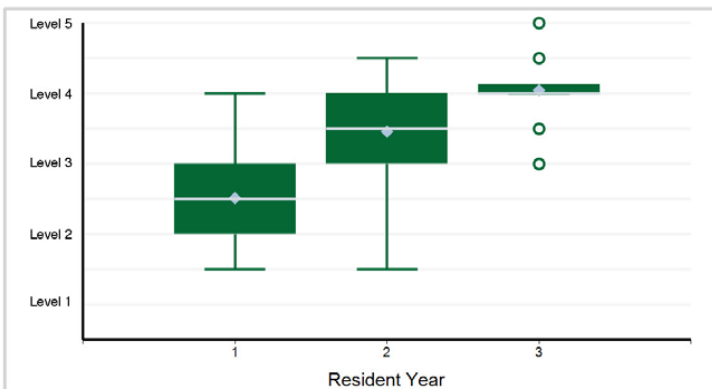

Note: 4 of 203 residents have a status of "Not Yet Rotated" and are not included in the analysis.

8. Medical Knowledge - Congenital Anomalies — Medical Knowledge

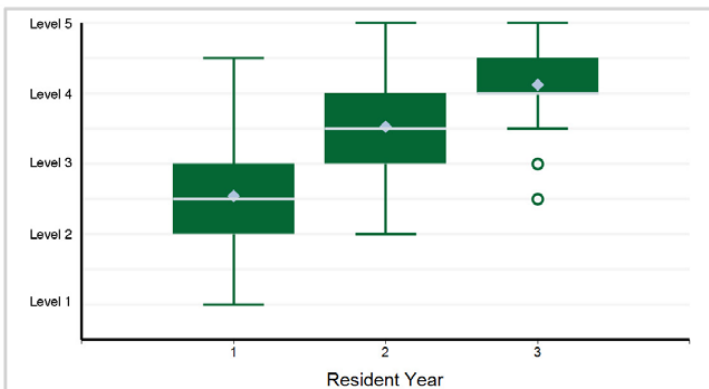

Note: 4 of 203 residents have a status of "Not Yet Rotated" and are not included in the analysis.

9. Patient Care - Head and Neck — Patient Care

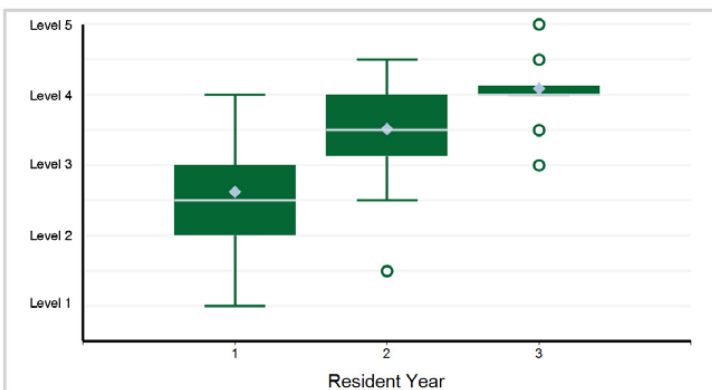

Note: 4 of 203 residents have a status of "Not Yet Rotated" and are not included in the analysis.

10. Medical Knowledge - Head and Neck — Medical Knowledge

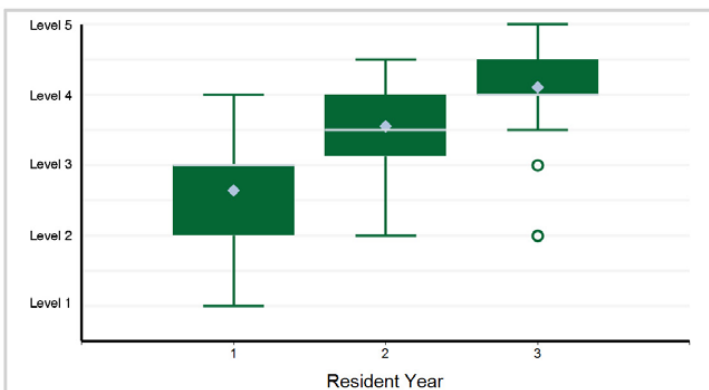

Note: 4 of 203 residents have a status of "Not Yet Rotated" and are not included in the analysis.

11. Patient Care - Maxillofacial Trauma — Patient Care

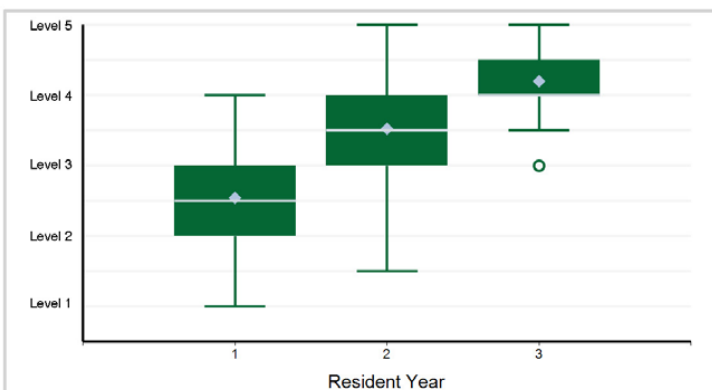

Note: 1 of 203 residents have a status of "Not Yet Rotated" and are not included in the analysis.

12. Medical Knowledge - Maxillofacial Trauma — Medical Knowledge

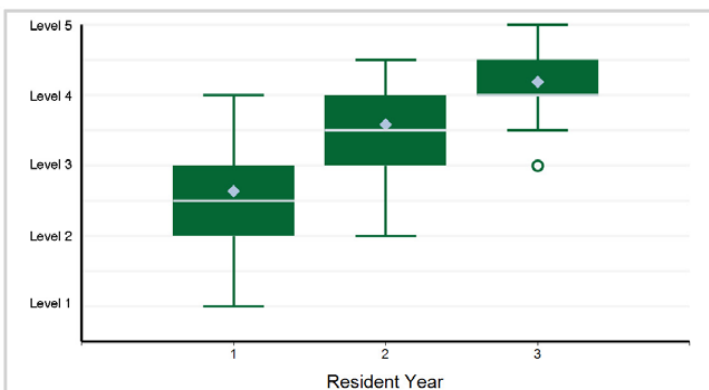

Note: 1 of 203 residents have a status of "Not Yet Rotated" and are not included in the analysis.

Specialty Box Plot Report - Milestone Evaluation by Resident Year: Year-End 2021-2022

SPECIALTY: Plastic Surgery - Independent

13. Patient Care - Facial Aesthetics — Patient Care

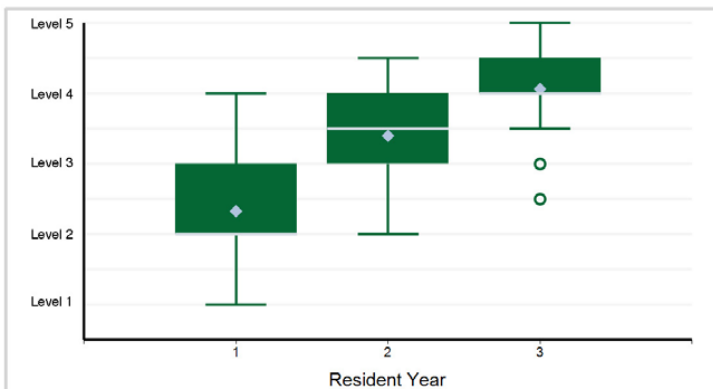

Note: 5 of 203 residents have a status of "Not Yet Rotated" and are not included in the analysis.

14. Medical Knowledge - Facial Aesthetics — Medical Knowledge

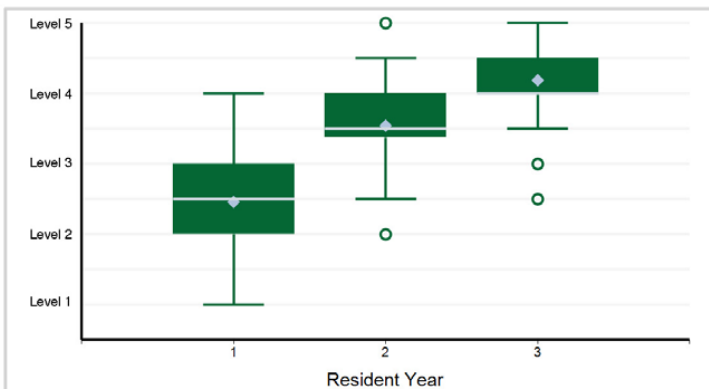

Note: 4 of 203 residents have a status of "Not Yet Rotated" and are not included in the analysis.

15. Patient Care - Non-Cancer Breast Surgery — Patient Care

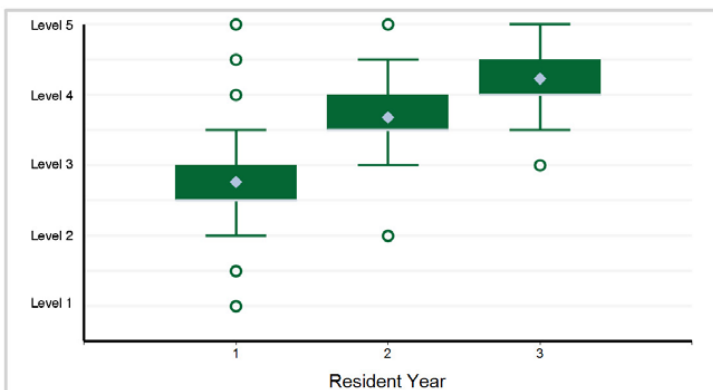

16. Medical Knowledge - Non-Cancer Breast Surgery — Medical Knowledge

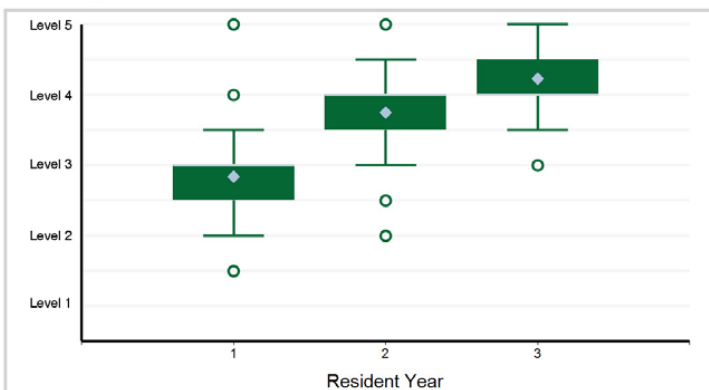

17. Patient Care - Breast Reconstruction — Patient Care

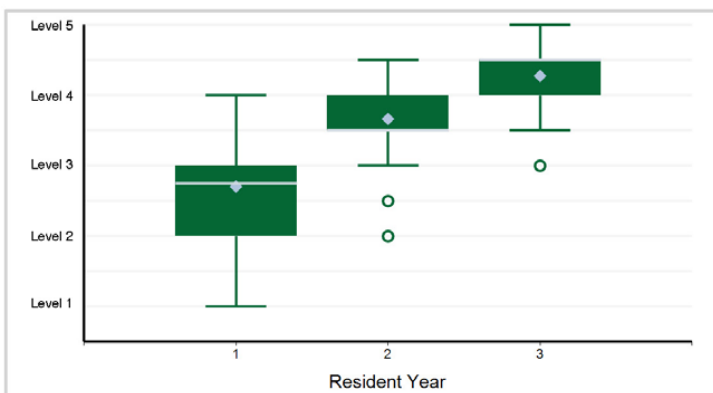

18. Medical Knowledge - Breast Reconstruction — Medical Knowledge

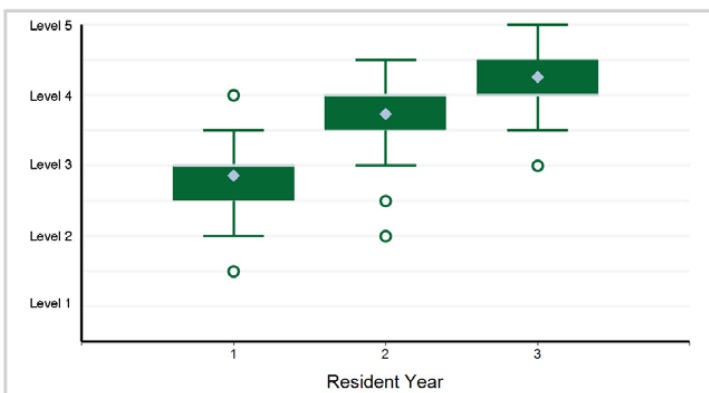

Specialty Box Plot Report - Milestone Evaluation by Resident Year: Year-End 2021-2022

SPECIALTY: Plastic Surgery - Independent

19. Patient Care - Reconstruction of the Trunk and Perineum — Patient Care

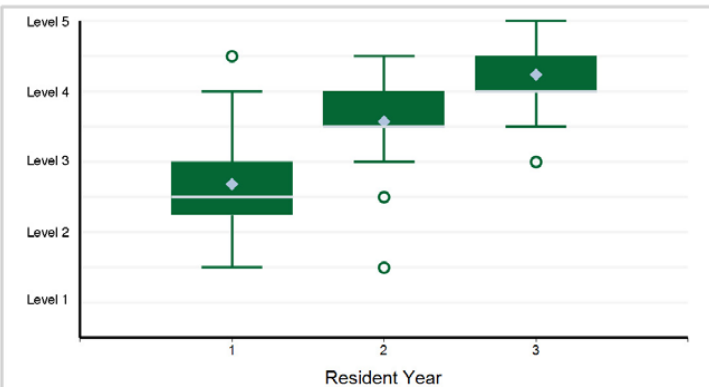

Note: 1 of 203 residents have a status of "Not Yet Rotated" and are not included in the analysis.

20. Medical Knowledge - Reconstruction of Trunk and Perineum — Medical Knowledge

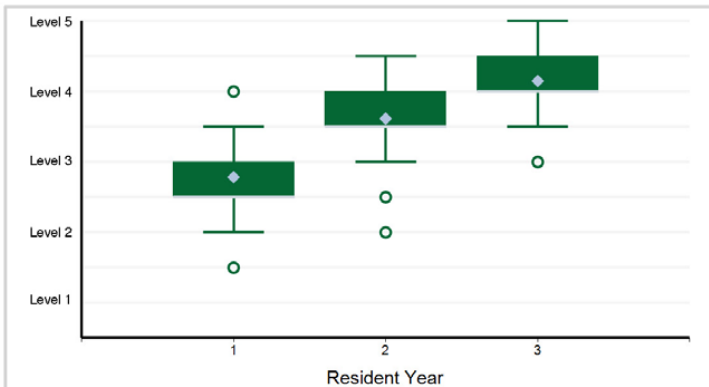

Note: 1 of 203 residents have a status of "Not Yet Rotated" and are not included in the analysis.

21. Patient Care - Upper Extremity Trauma — Patient Care

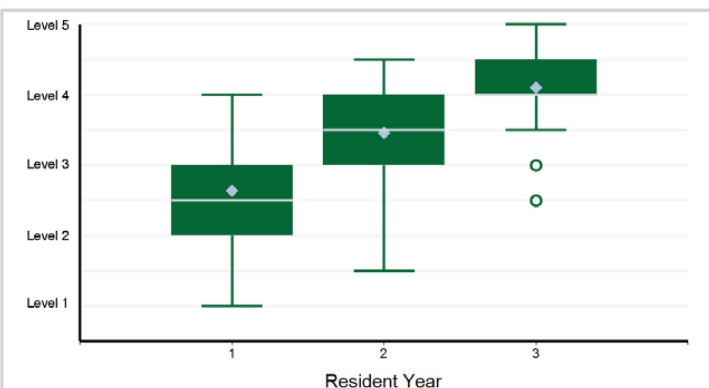

Note: 3 of 203 residents have a status of "Not Yet Rotated" and are not included in the analysis.

22. Medical Knowledge - Upper Extremity Trauma — Medical Knowledge

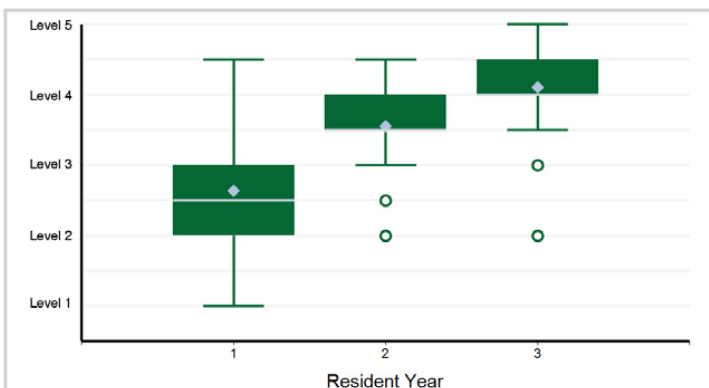

Note: 3 of 203 residents have a status of "Not Yet Rotated" and are not included in the analysis.

23. Patient Care - Non-trauma Hand — Patient Care

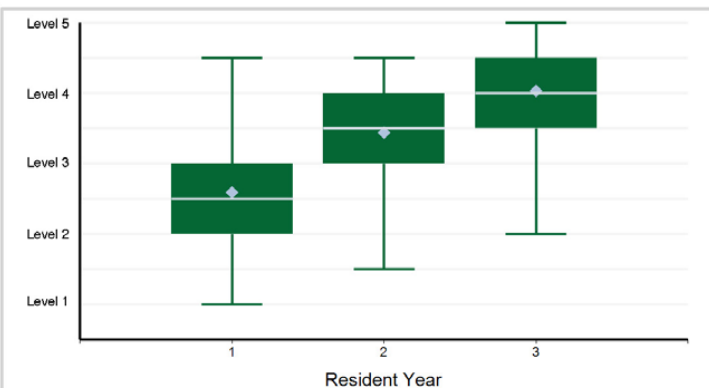

Note: 3 of 203 residents have a status of "Not Yet Rotated" and are not included in the analysis.

24. Medical Knowledge - Non-trauma Hand — Medical Knowledge

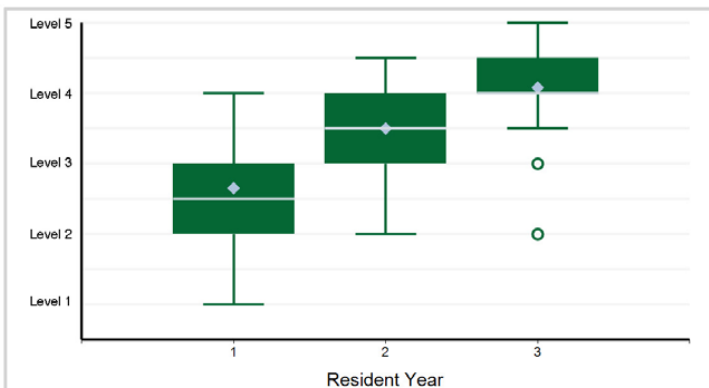

Note: 3 of 203 residents have a status of "Not Yet Rotated" and are not included in the analysis.

Specialty Box Plot Report - Milestone Evaluation by Resident Year: Year-End 2021-2022

SPECIALTY: Plastic Surgery - Independent

25. Patient Care - Cosmetic Trunk and Lower Extremity — Patient Care

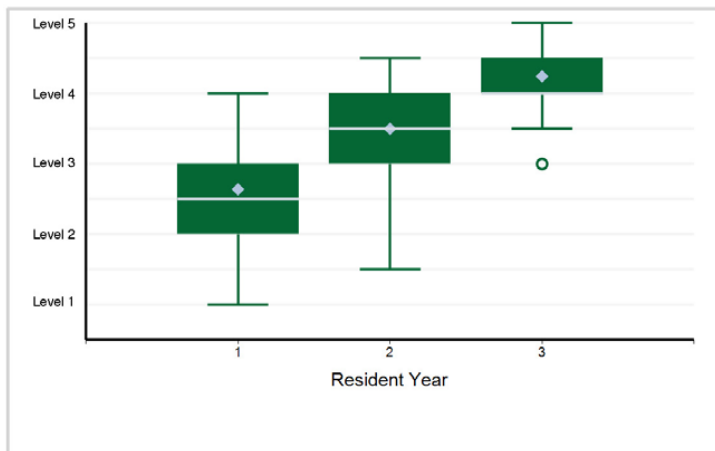

26. Medical Knowledge - Cosmetic Trunk and Lower Extremity — Medical Knowledge

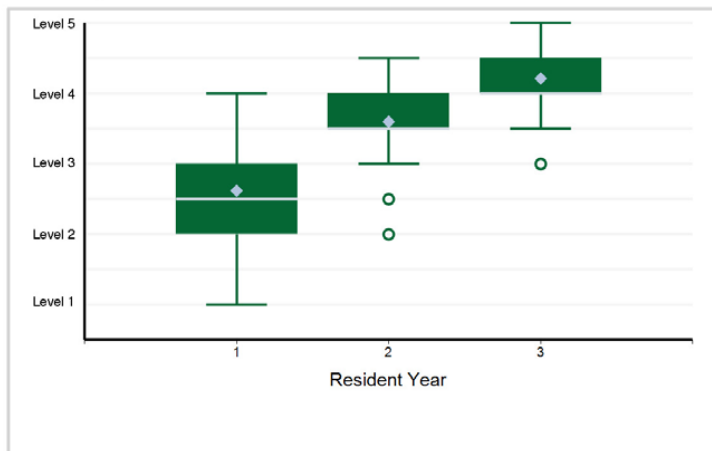

27. Patient Care - Lower Extremity — Patient Care

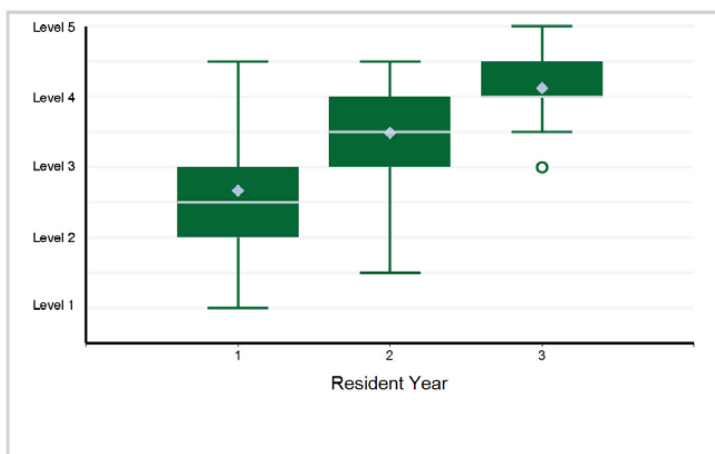

28. Medical Knowledge - Lower Extremity — Medical Knowledge

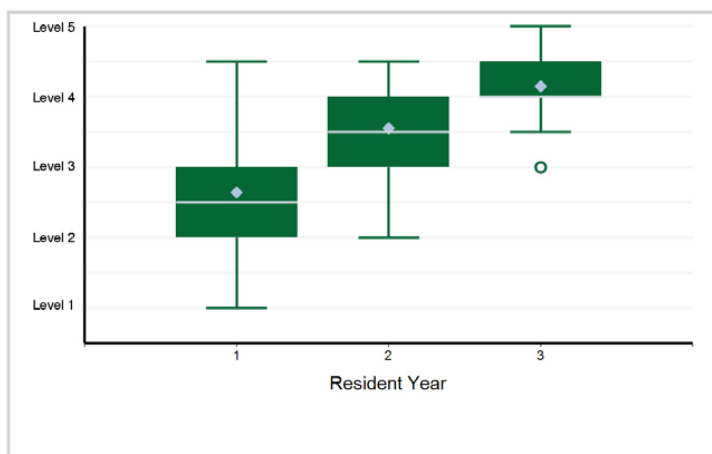

29. Systems-Based Practice - Patient Safety — Systems-Based Practice

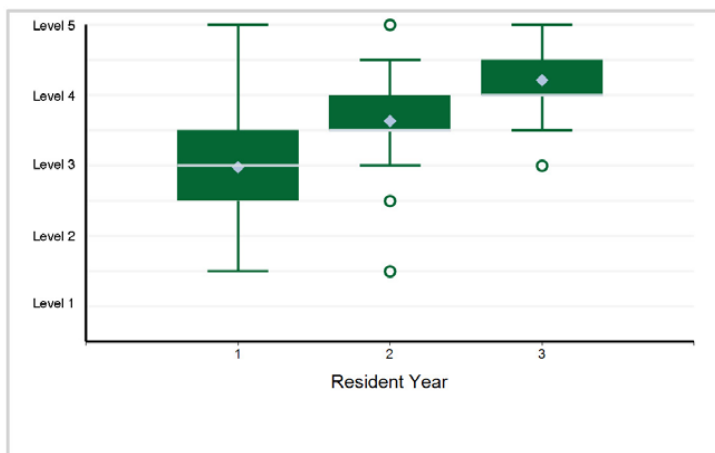

30. Systems-Based Practice - Resource Allocation — Systems-Based Practice

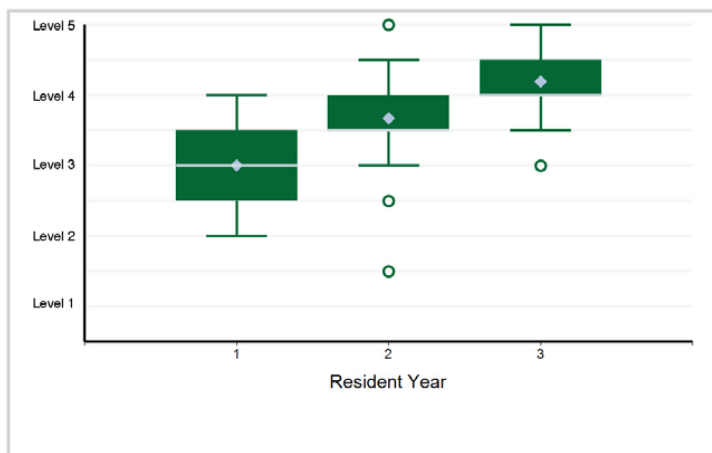

Specialty Box Plot Report - Milestone Evaluation by Resident Year: Year-End 2021-2022

SPECIALTY: Plastic Surgery - Independent

31. Systems-Based Practice - Practice Management — Systems-Based Practice

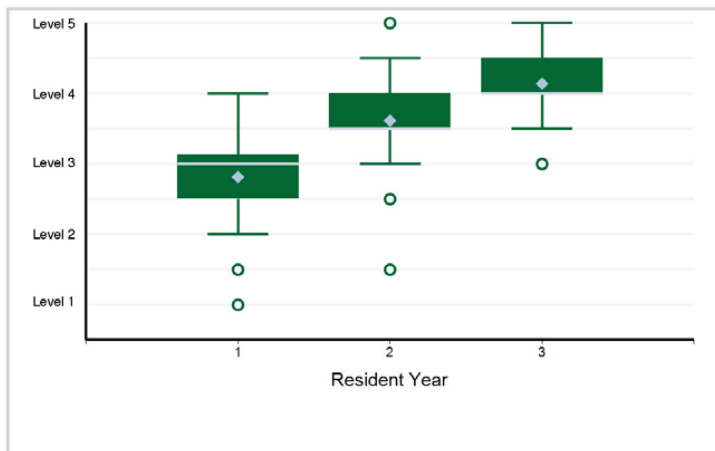

32. Practice-Based Learning and Improvement - The ability to investigate and evaluate the care of patients, to appraise and ...

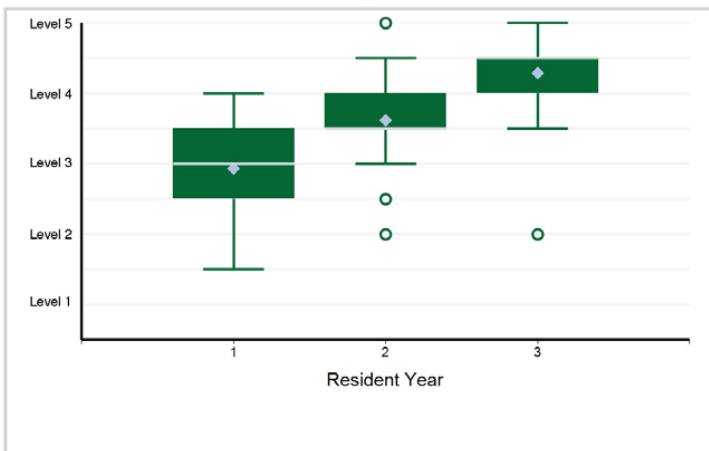

33. Practice-Based Learning and Improvement - Research and Teaching — Practice-Based Learning and Improvement

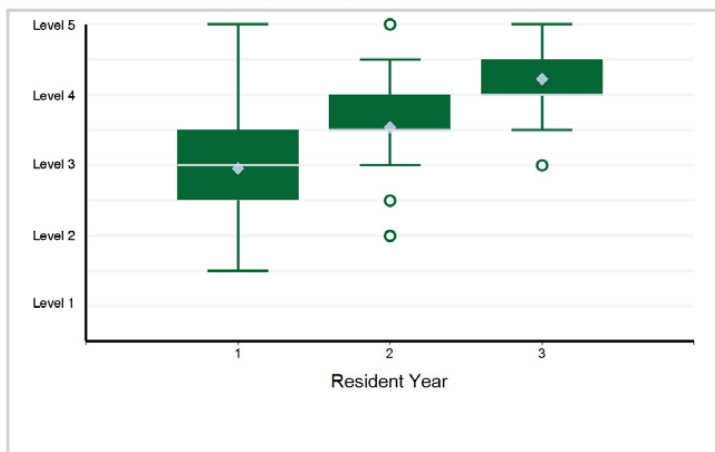

34. Professionalism - Ethics and Values — Professionalism

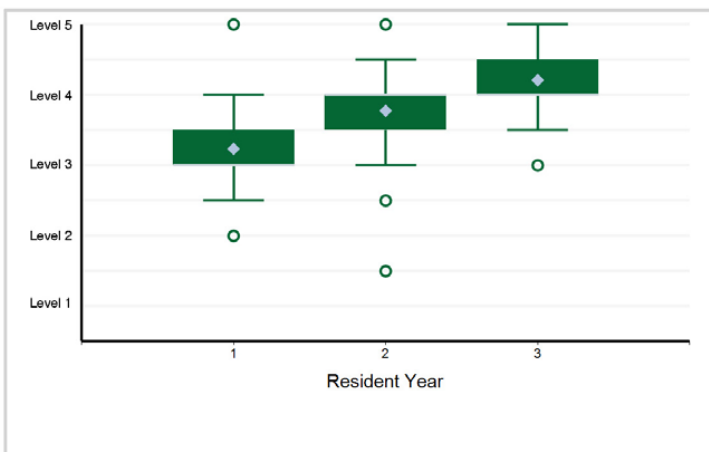

35. Professionalism - Personal Accountability — Professionalism

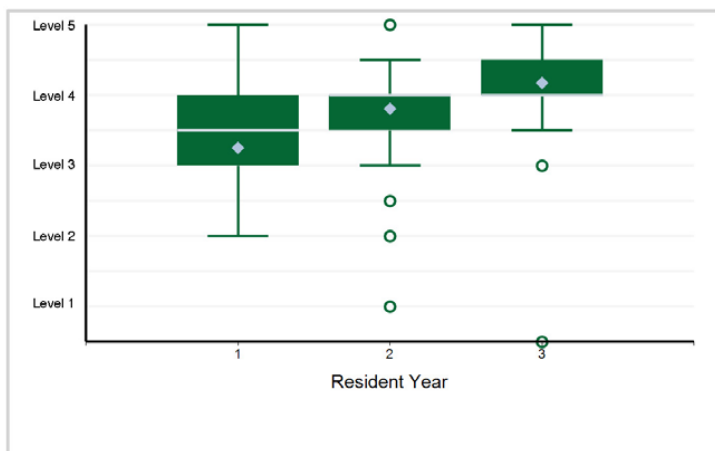

36. Interpersonal and Communication Skills - Interpersonal and Communication Skills

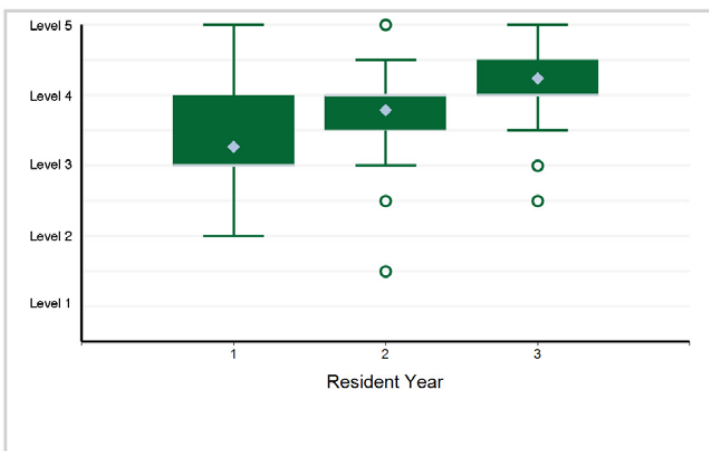

Specialty Box Plot Report - Milestone Evaluation by Resident Year: Year-End 2021-2022

TABLE 118: SPECIALTY: **Plastic Surgery - Integrated**

Resident Year	1	2	3	4	5	6	Total Residents
# of Residents	195	181	182	177	169	157	1,061

1. Patient Care - Surgical Care — Patient Care

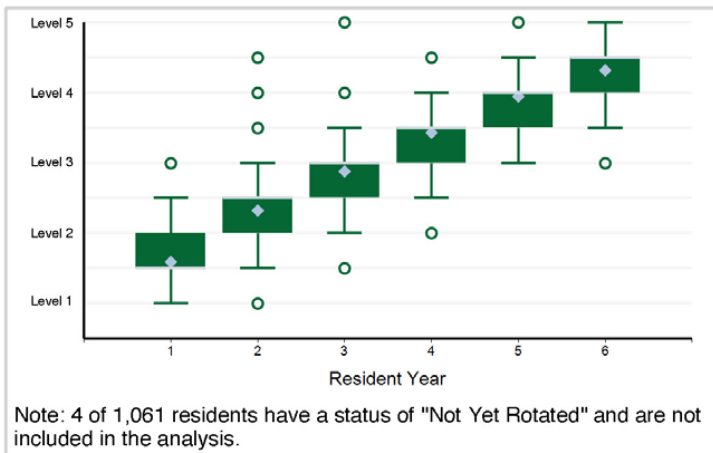

2. Medical Knowledge - Surgical Care — Medical Knowledge

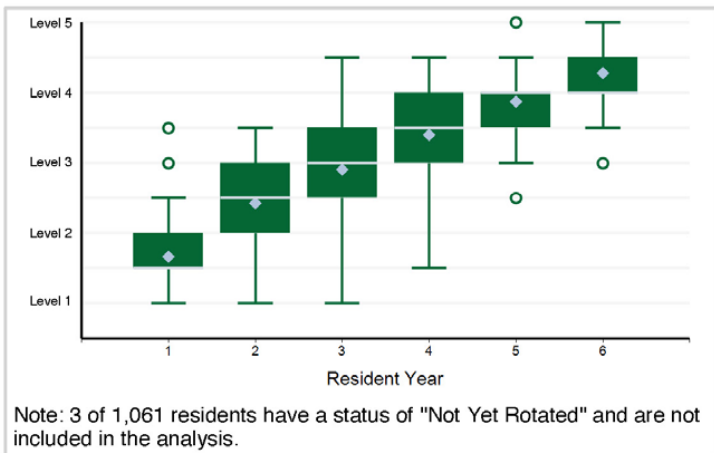

3. Patient Care - Wound Care — Patient Care

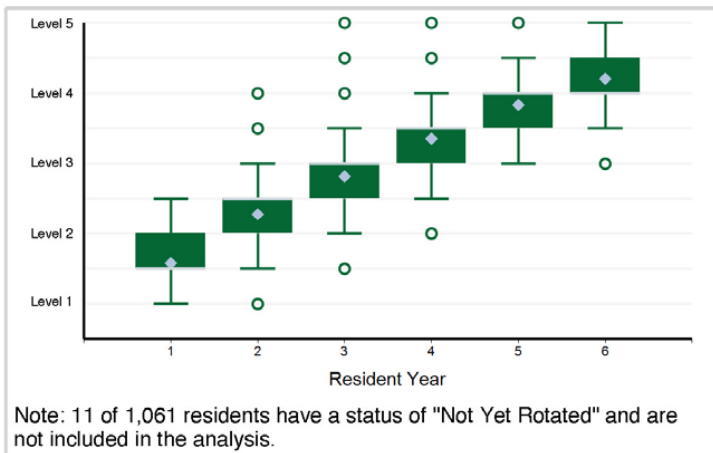

4. Medical Knowledge - Wound Care — Medical Knowledge

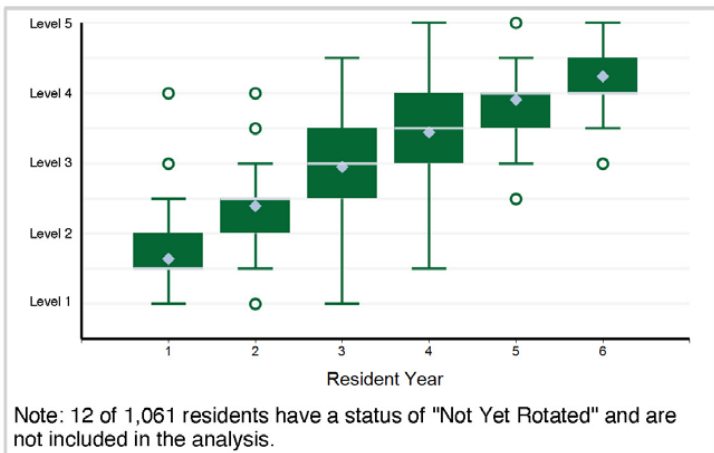

5. Patient Care - Tissue Transfer — Patient Care

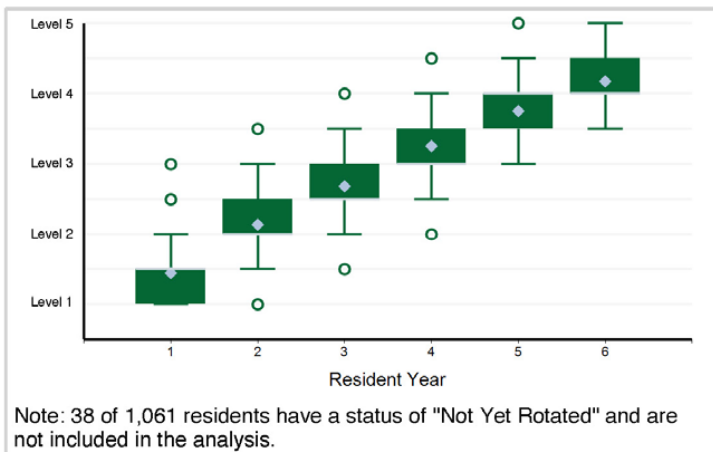

6. Medical Knowledge - Tissue Transfer — Medical Knowledge

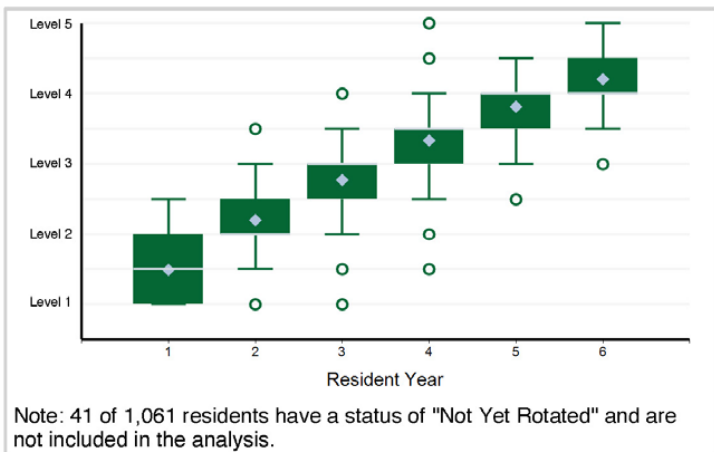

Specialty Box Plot Report - Milestone Evaluation by Resident Year: Year-End 2021-2022

SPECIALTY: Plastic Surgery - Integrated

7. Patient Care - Congenital Anomalies — Patient Care

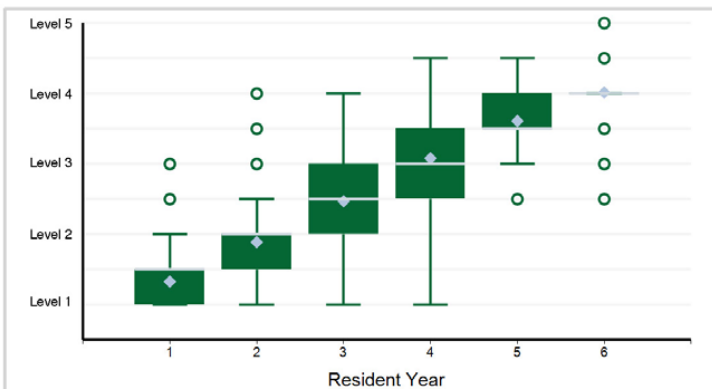

Note: 123 of 1,061 residents have a status of "Not Yet Rotated" and are not included in the analysis.

8. Medical Knowledge - Congenital Anomalies — Medical Knowledge

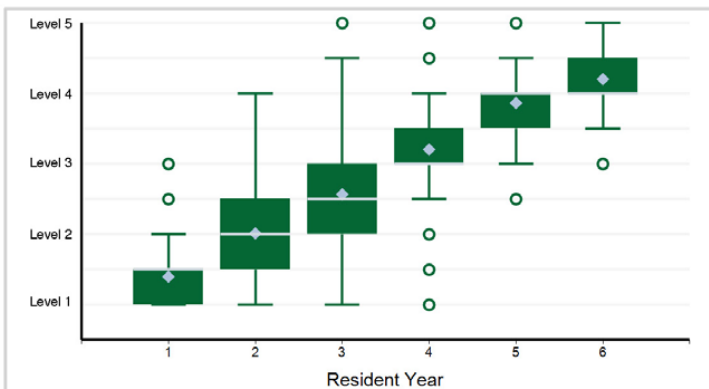

Note: 98 of 1,061 residents have a status of "Not Yet Rotated" and are not included in the analysis.

9. Patient Care - Head and Neck — Patient Care

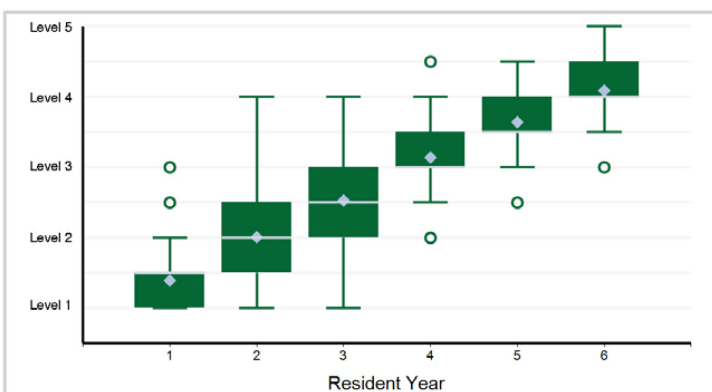

Note: 89 of 1,061 residents have a status of "Not Yet Rotated" and are not included in the analysis.

10. Medical Knowledge - Head and Neck — Medical Knowledge

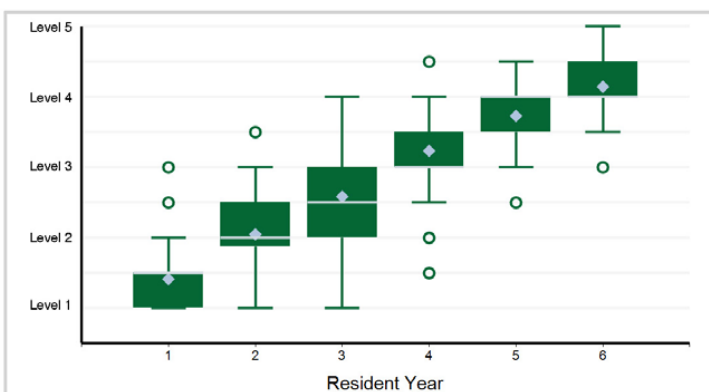

Note: 86 of 1,061 residents have a status of "Not Yet Rotated" and are not included in the analysis.

11. Patient Care - Maxillofacial Trauma — Patient Care

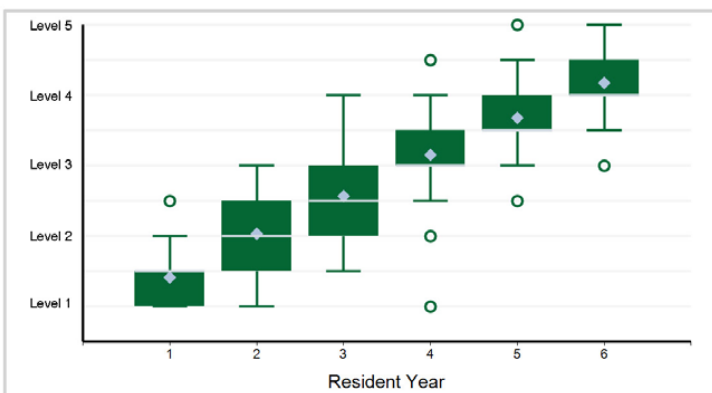

Note: 56 of 1,061 residents have a status of "Not Yet Rotated" and are not included in the analysis.

12. Medical Knowledge - Maxillofacial Trauma — Medical Knowledge

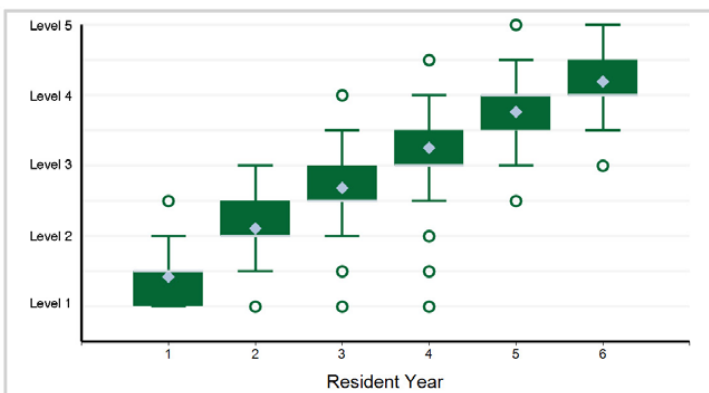

Note: 54 of 1,061 residents have a status of "Not Yet Rotated" and are not included in the analysis.

Specialty Box Plot Report - Milestone Evaluation by Resident Year: Year-End 2021-2022

SPECIALTY: Plastic Surgery - Integrated

13. Patient Care - Facial Aesthetics — Patient Care

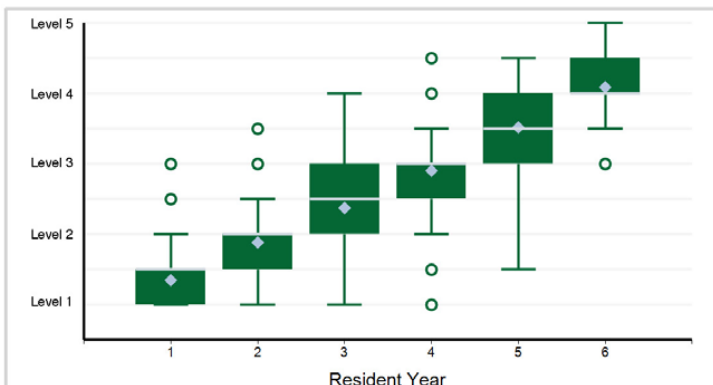

Note: 164 of 1,061 residents have a status of "Not Yet Rotated" and are not included in the analysis.

14. Medical Knowledge - Facial Aesthetics — Medical Knowledge

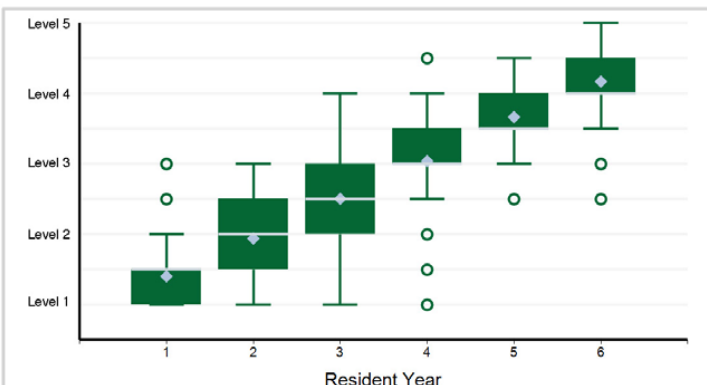

Note: 141 of 1,061 residents have a status of "Not Yet Rotated" and are not included in the analysis.

15. Patient Care - Non-Cancer Breast Surgery — Patient Care

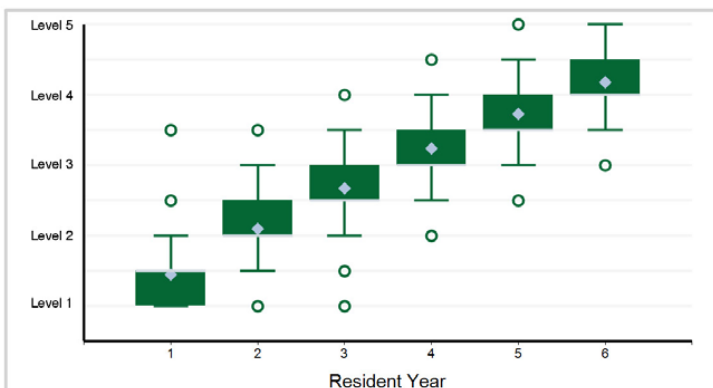

Note: 47 of 1,061 residents have a status of "Not Yet Rotated" and are not included in the analysis.

16. Medical Knowledge - Non-Cancer Breast Surgery — Medical Knowledge

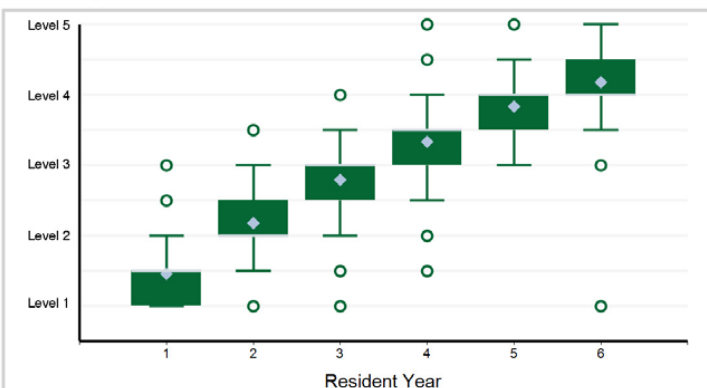

Note: 40 of 1,061 residents have a status of "Not Yet Rotated" and are not included in the analysis.

17. Patient Care - Breast Reconstruction — Patient Care

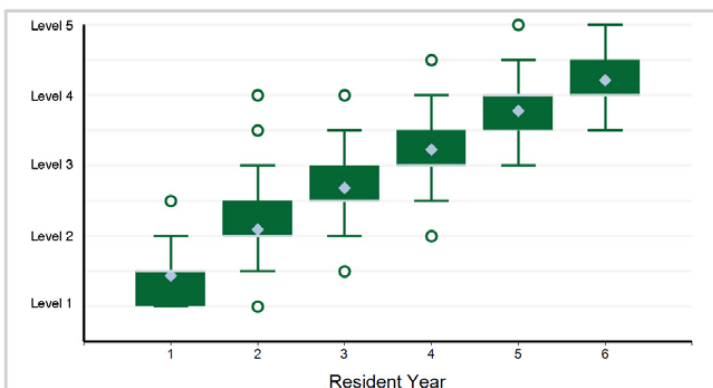

Note: 44 of 1,061 residents have a status of "Not Yet Rotated" and are not included in the analysis.

18. Medical Knowledge - Breast Reconstruction — Medical Knowledge

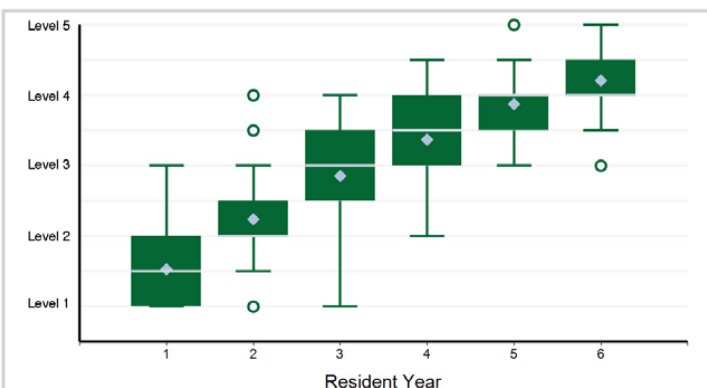

Note: 35 of 1,061 residents have a status of "Not Yet Rotated" and are not included in the analysis.

Specialty Box Plot Report - Milestone Evaluation by Resident Year: Year-End 2021-2022

SPECIALTY: Plastic Surgery - Integrated

19. Patient Care - Reconstruction of the Trunk and Perineum — Patient Care

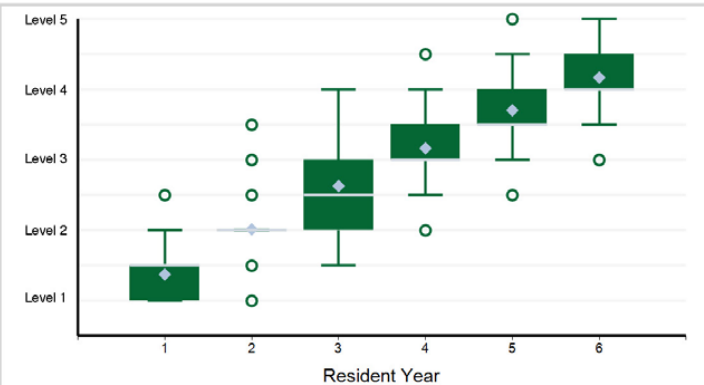

Note: 49 of 1,061 residents have a status of "Not Yet Rotated" and are not included in the analysis.

20. Medical Knowledge - Reconstruction of Trunk and Perineum — Medical Knowledge

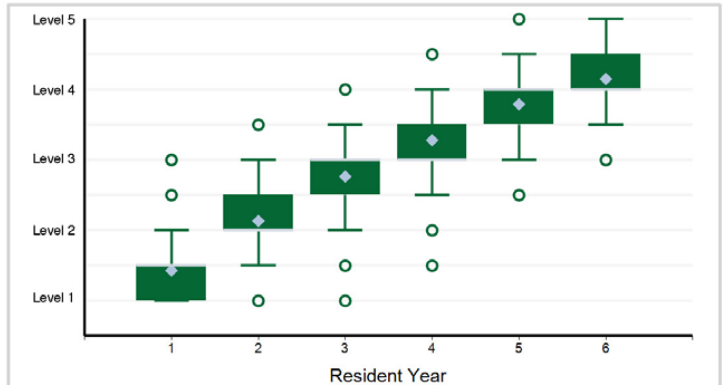

Note: 48 of 1,061 residents have a status of "Not Yet Rotated" and are not included in the analysis.

21. Patient Care - Upper Extremity Trauma — Patient Care

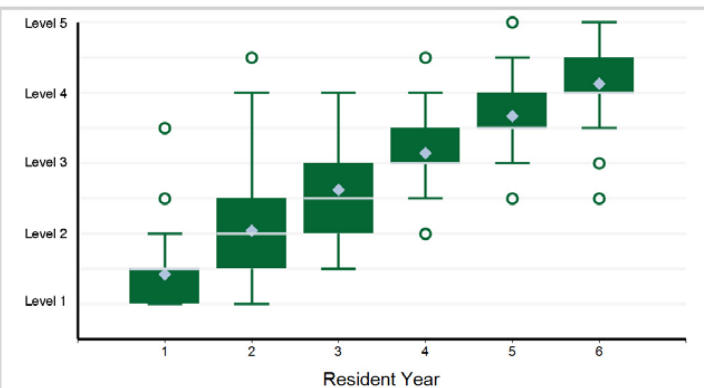

Note: 54 of 1,061 residents have a status of "Not Yet Rotated" and are not included in the analysis.

22. Medical Knowledge - Upper Extremity Trauma — Medical Knowledge

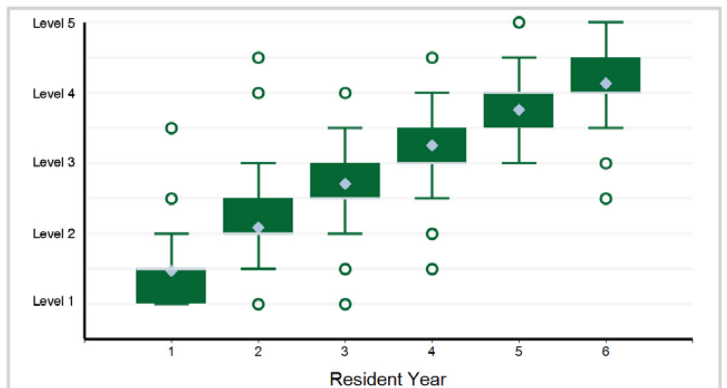

Note: 54 of 1,061 residents have a status of "Not Yet Rotated" and are not included in the analysis.

23. Patient Care - Non-trauma Hand — Patient Care

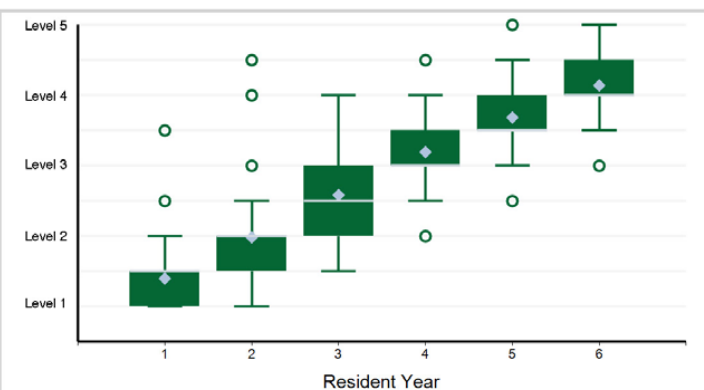

Note: 77 of 1,061 residents have a status of "Not Yet Rotated" and are not included in the analysis.

24. Medical Knowledge - Non-trauma Hand — Medical Knowledge

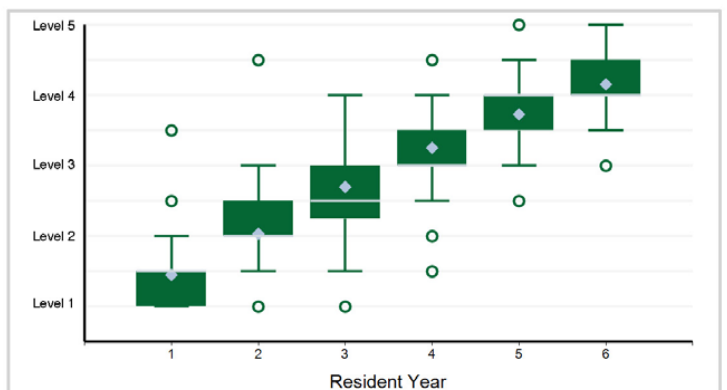

Note: 77 of 1,061 residents have a status of "Not Yet Rotated" and are not included in the analysis.

Specialty Box Plot Report - Milestone Evaluation by Resident Year: Year-End 2021-2022

SPECIALTY: Plastic Surgery - Integrated

25. Patient Care - Cosmetic Trunk and Lower Extremity — Patient Care

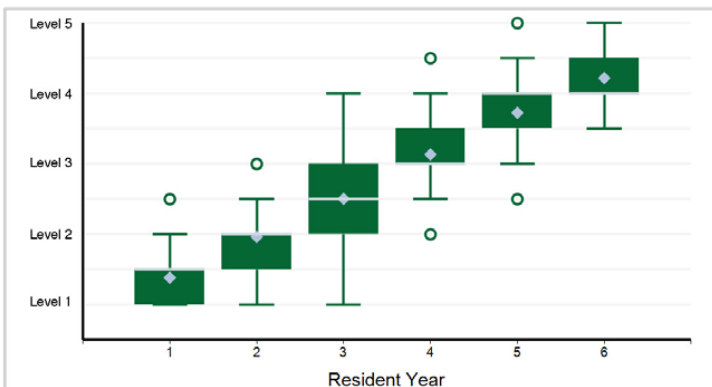

Note: 143 of 1,061 residents have a status of "Not Yet Rotated" and are not included in the analysis.

26. Medical Knowledge - Cosmetic Trunk and Lower Extremity — Medical Knowledge

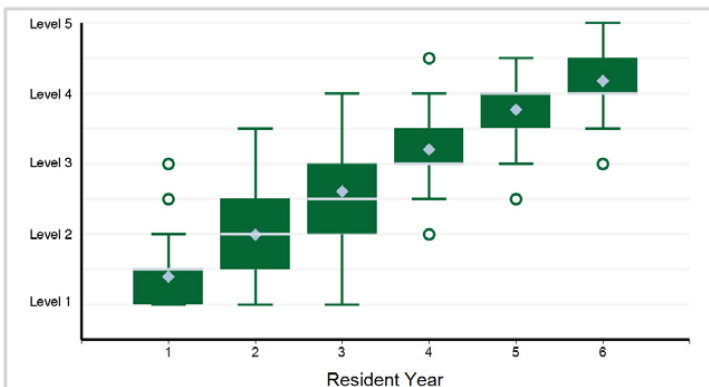

Note: 126 of 1,061 residents have a status of "Not Yet Rotated" and are not included in the analysis.

27. Patient Care - Lower Extremity — Patient Care

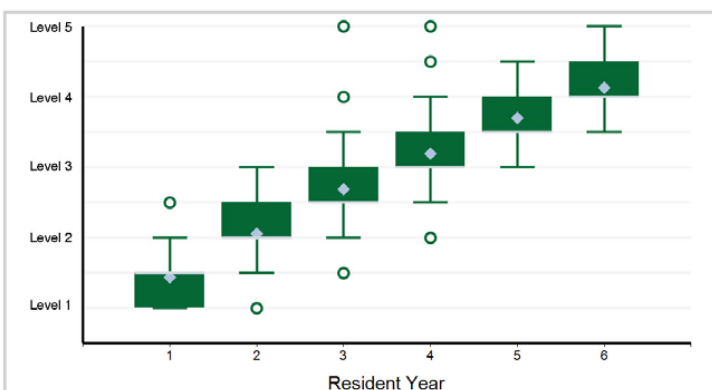

Note: 41 of 1,061 residents have a status of "Not Yet Rotated" and are not included in the analysis.

28. Medical Knowledge - Lower Extremity — Medical Knowledge

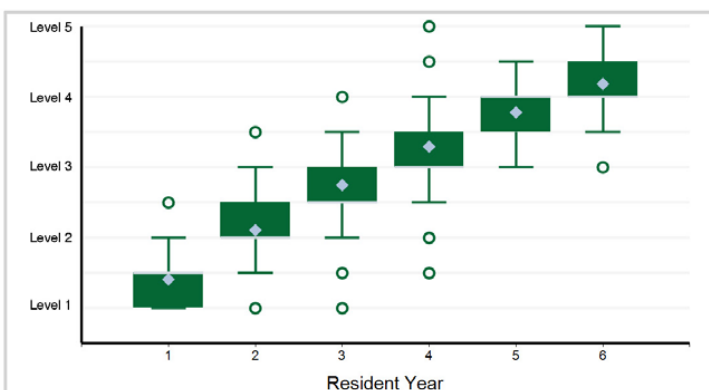

Note: 39 of 1,061 residents have a status of "Not Yet Rotated" and are not included in the analysis.

29. Systems-Based Practice - Patient Safety — Systems-Based Practice

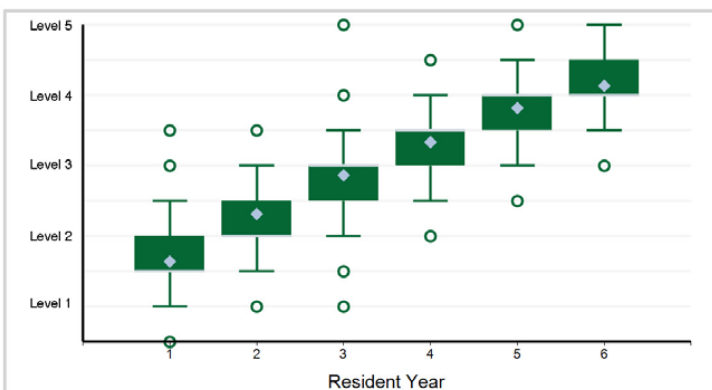

30. Systems-Based Practice - Resource Allocation — Systems-Based Practice

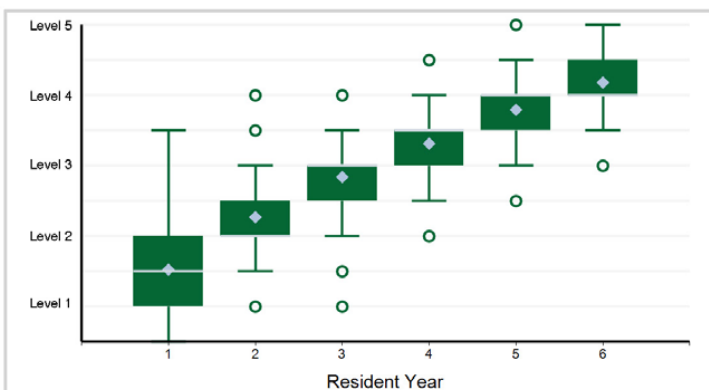

Specialty Box Plot Report - Milestone Evaluation by Resident Year: Year-End 2021-2022

SPECIALTY: Plastic Surgery - Integrated

31. Systems-Based Practice - Practice Management — Systems-Based Practice

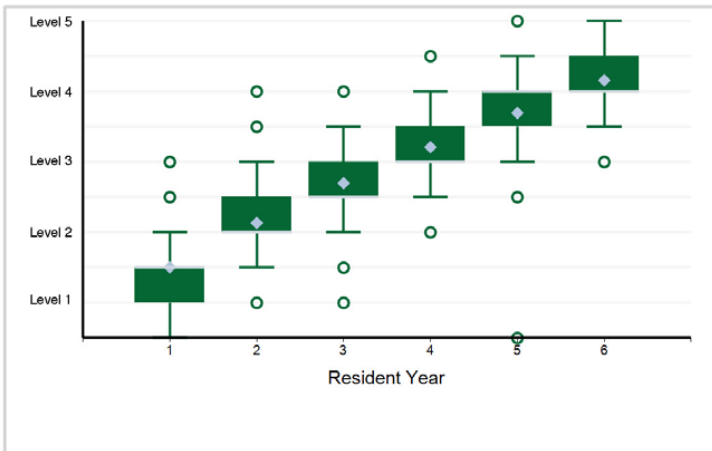

32. Practice-Based Learning and Improvement - The ability to investigate and evaluate the care of patients, to appraise and ...

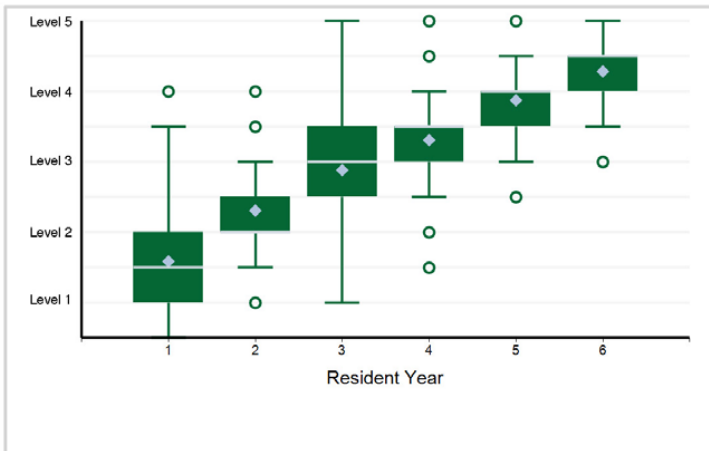

33. Practice-Based Learning and Improvement - Research and Teaching — Practice-Based Learning and Improvement

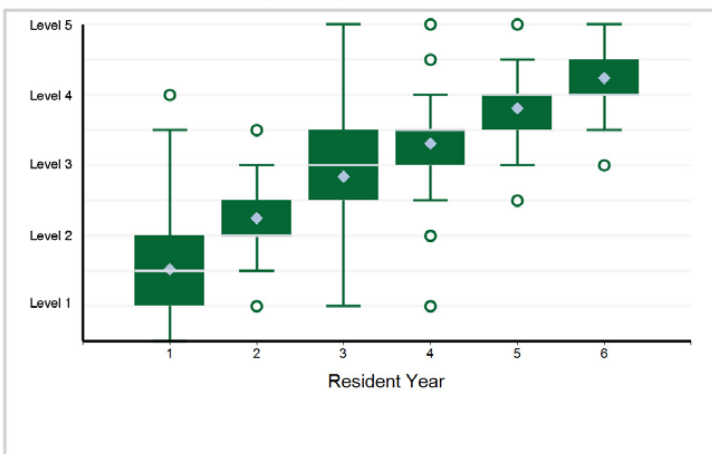

34. Professionalism - Ethics and Values — Professionalism

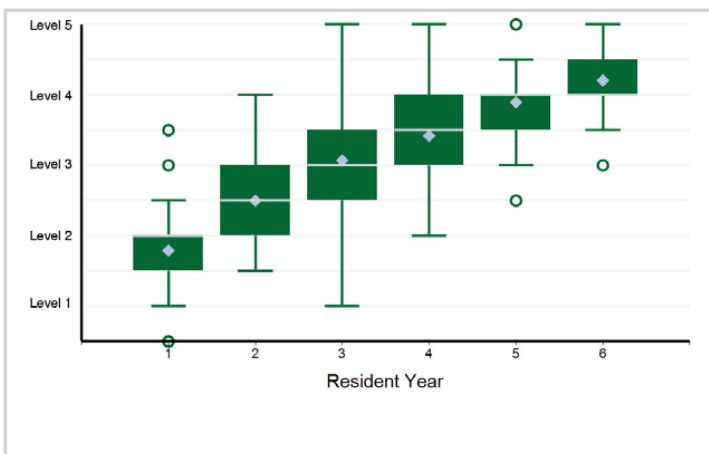

35. Professionalism - Personal Accountability — Professionalism

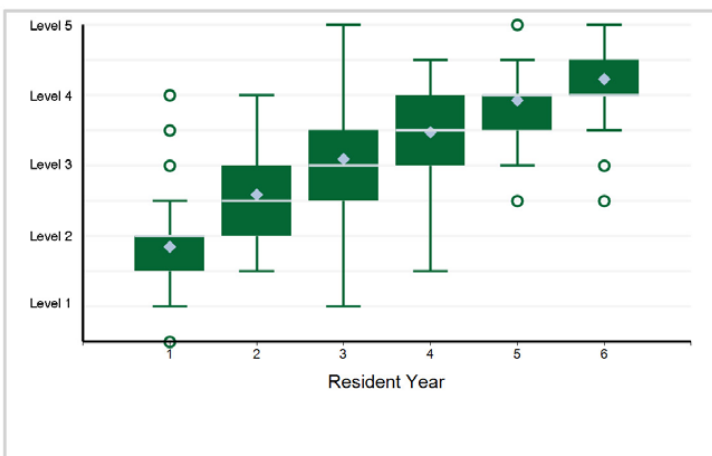

36. Interpersonal and Communication Skills - Interpersonal and Communication Skills

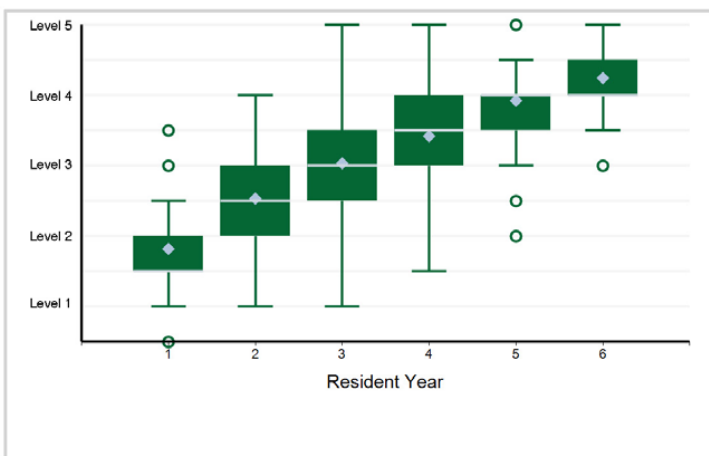

Specialty Box Plot Report - Milestone Evaluation by Resident Year: Year-End 2021-2022

TABLE 119: SUBSPECIALTY: **Hand Surgery (multidisciplinary, Plastic Surgery)**

Resident Year	1	Total Residents*
# of Residents	25	25

*Note: There are 2 residents with an incomplete milestone evaluation that are excluded from the box plots below.

1. Patient Care - Acquired Conditions (Tumor, Dupuytren's, tenosynovitis, vascular, contractures) — Patient Care



2. Medical Knowledge - Acquired Conditions (Tumor, Dupuytren's, tenosynovitis, vascular, contractures) — Medical Knowledge



3. Patient Care - Arthritis — Patient Care

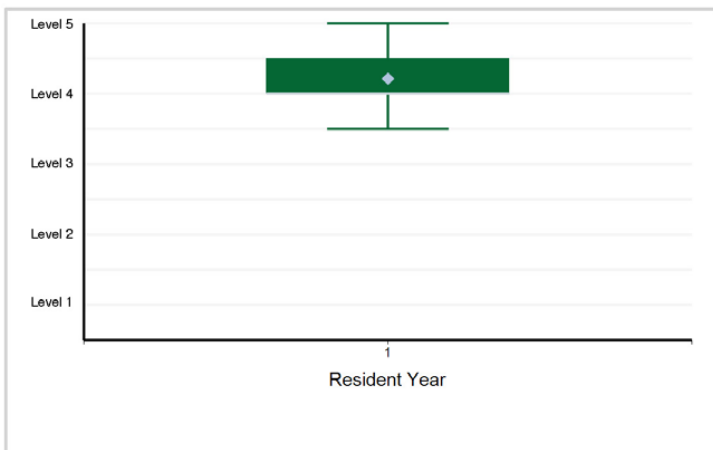

4. Medical Knowledge - Arthritis — Medical Knowledge



5. Patient Care - Congenital — Patient Care

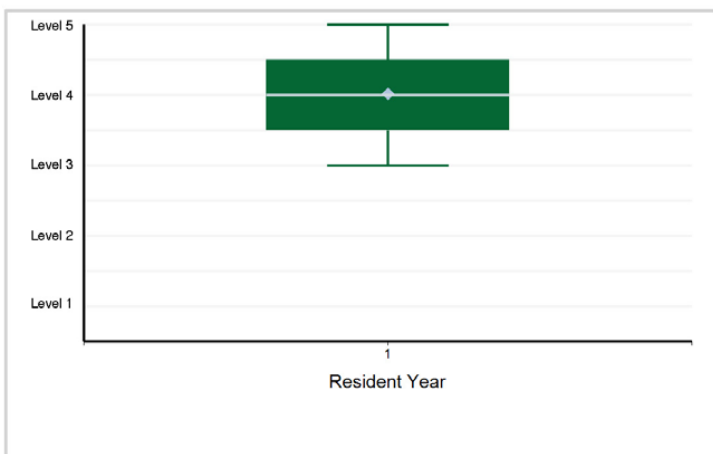

6. Medical Knowledge - Congenital — Medical Knowledge

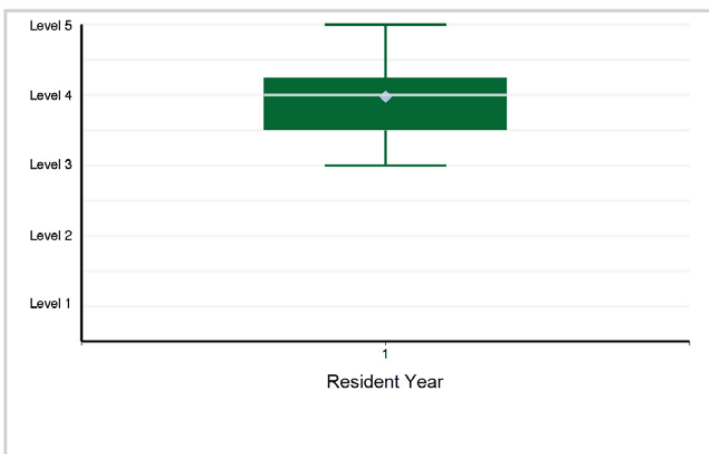

Specialty Box Plot Report - Milestone Evaluation by Resident Year: Year-End 2021-2022

SUBSPECIALTY: Hand Surgery (multidisciplinary, Plastic Surgery)

7. Patient Care - Nerve — Patient Care

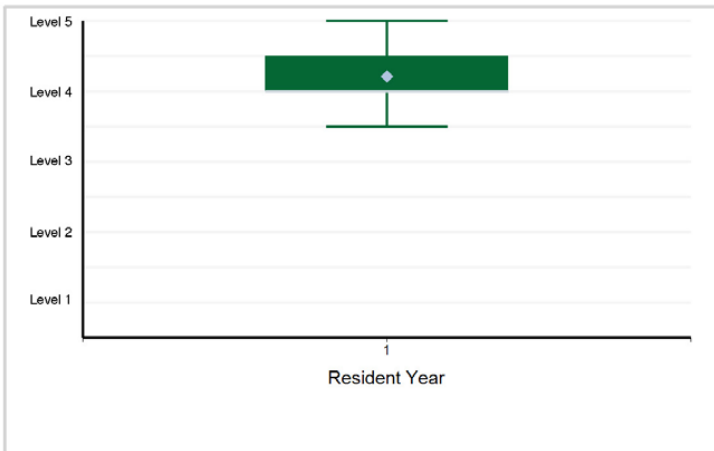

8. Medical Knowledge - Nerve — Medical Knowledge

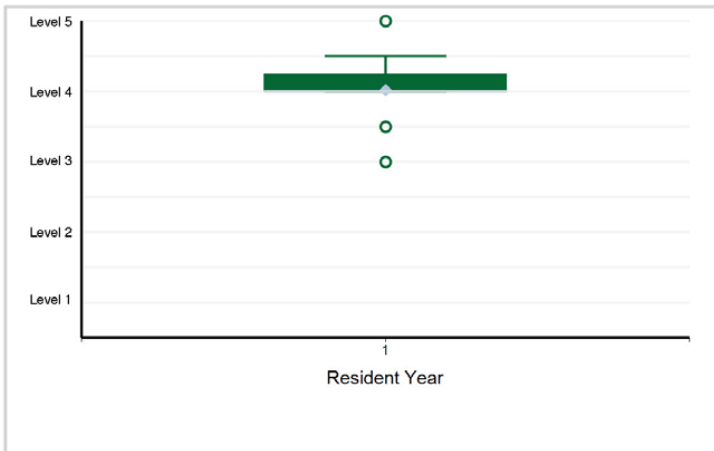

9. Patient Care - Trauma: Bone, Joint — Patient Care

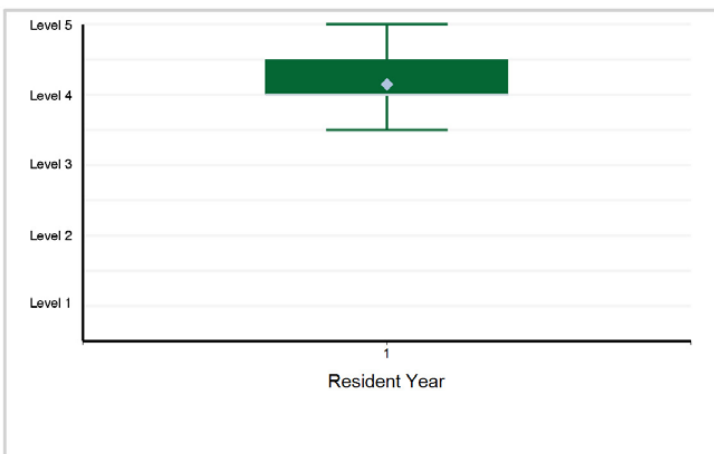

10. Medical Knowledge - Trauma: Bone, Joint — Medical Knowledge

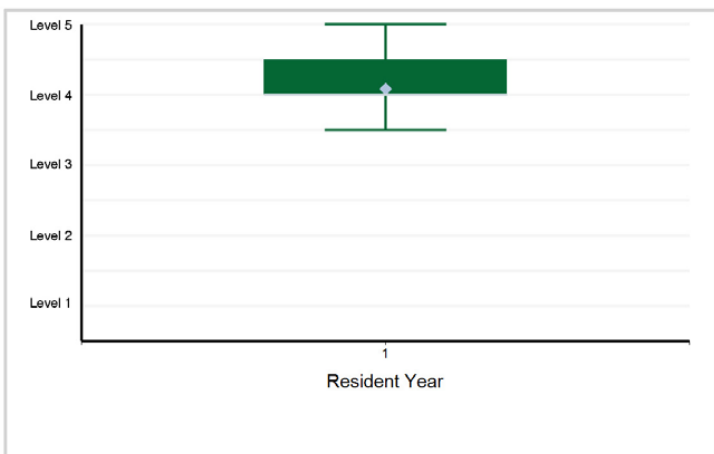

11. Patient Care - Soft Tissue Trauma, Infections — Patient Care

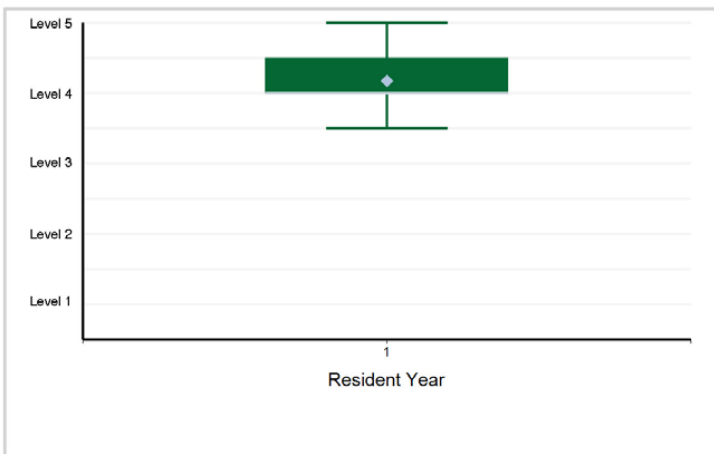

12. Medical Knowledge - Soft Tissue Trauma, Infections — Medical Knowledge

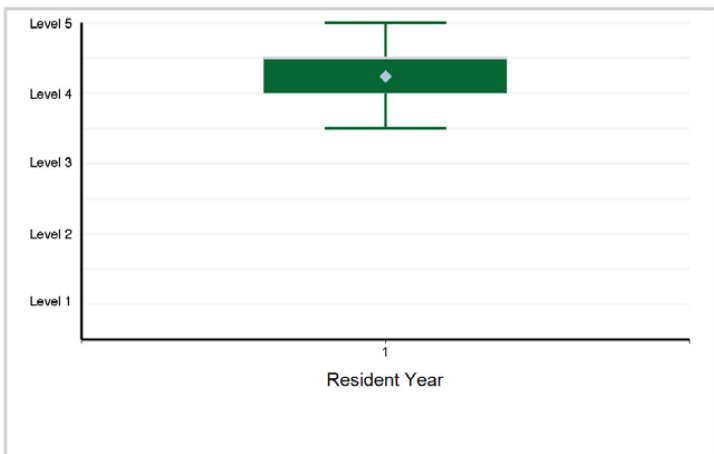

Specialty Box Plot Report - Milestone Evaluation by Resident Year: Year-End 2021-2022

SUBSPECIALTY: Hand Surgery (multidisciplinary, Plastic Surgery)

13. Patient Care - Tendon — Patient Care

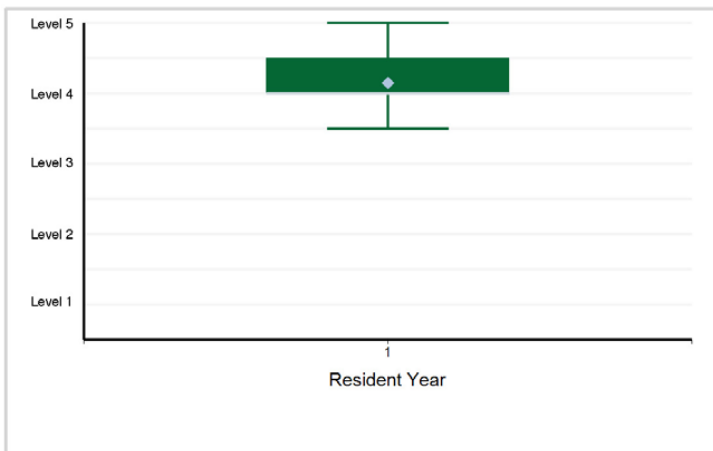

14. Medical Knowledge - Tendon — Medical Knowledge



15. Systems-Based Practice - Patient Safety, Resource Allocation, Practice Management — Systems-Based Practice



16. Practice-Based Learning and Improvement - The ability to investigate and evaluate the care of patients, to appraise and ...

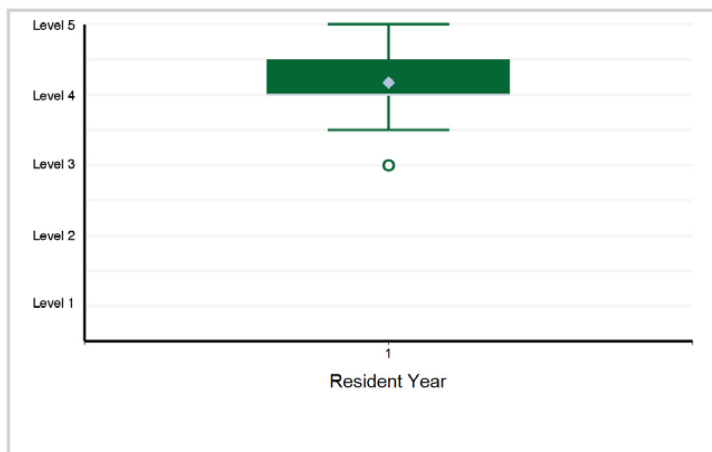

17. Professionalism - Ethics and Values — Professionalism

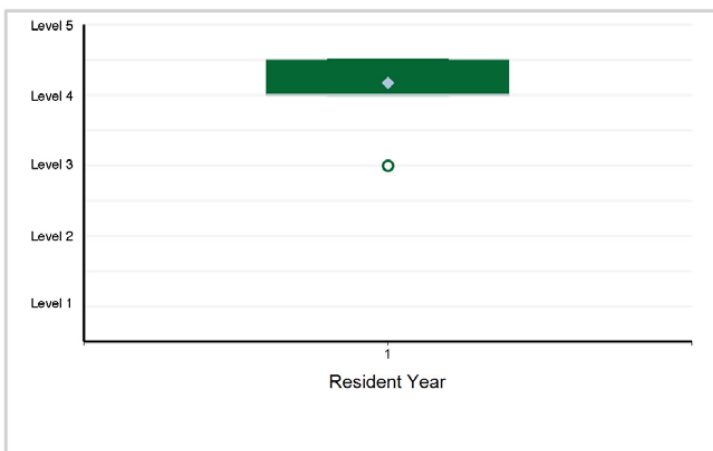

18. Interpersonal and Communication Skills - Interpersonal and Communication Skills

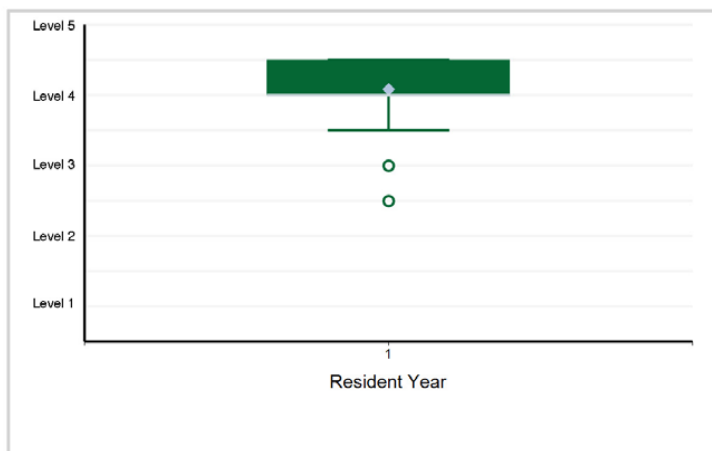

Specialty Box Plot Report - Milestone Evaluation by Resident Year: Year-End 2021-2022

TABLE 120: SPECIALTY: Preventive Medicine - Aerospace Medicine

Resident Year	1	2	Total Residents
# of Residents	24	24	48

1. Patient Care - Patient Care 1: Health and Performance Optimization

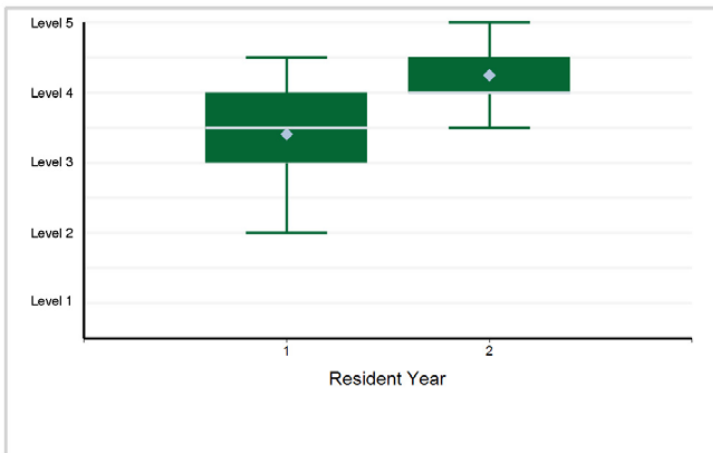

2. Patient Care - Patient Care 2: Fitness for Duty and Medical Standards

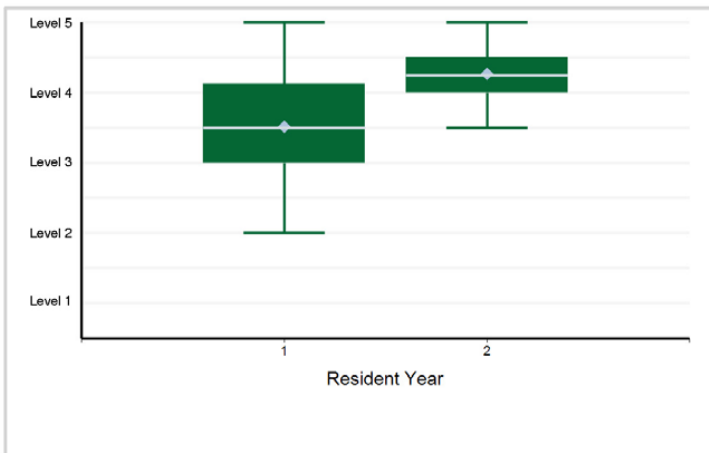

3. Patient Care - Patient Care 3: Hazard Recognition, Mitigation, and Management

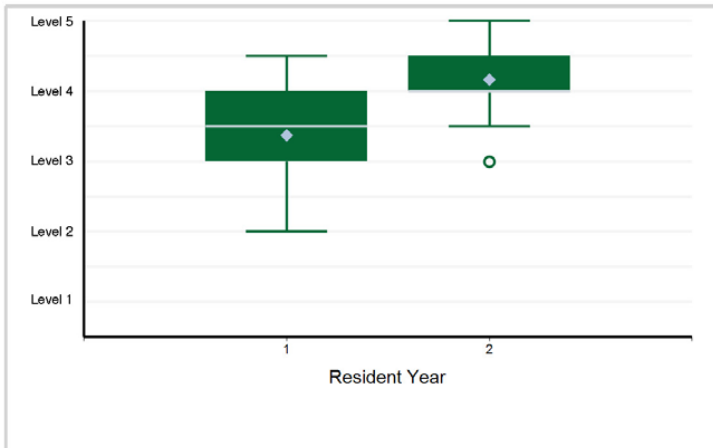

4. Patient Care - Patient Care 4: Clinical Care Skills

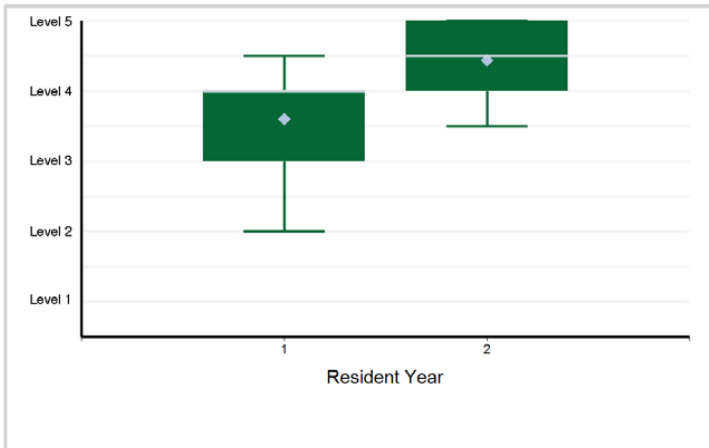

5. Patient Care - Patient Care 5: Air and Space Environment

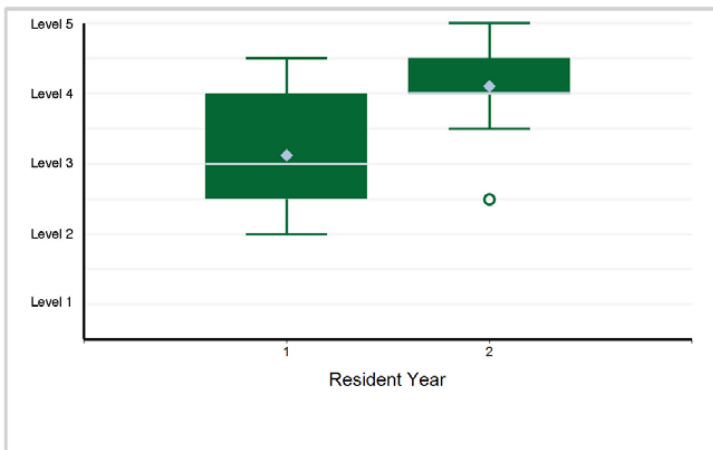

6. Patient Care - Patient Care 6: Aeromedical Transport

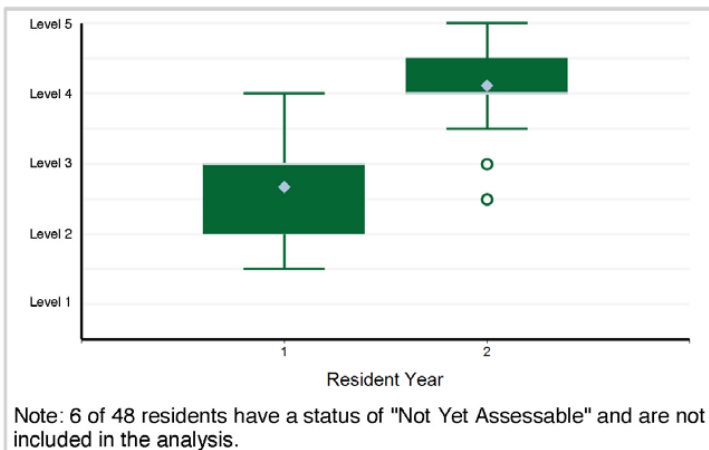

Note: 6 of 48 residents have a status of "Not Yet Assessable" and are not included in the analysis.

Specialty Box Plot Report - Milestone Evaluation by Resident Year: Year-End 2021-2022

SPECIALTY: Preventive Medicine - Aerospace Medicine

7. Medical Knowledge - Medical Knowledge 1: Biostatistics and Epidemiology

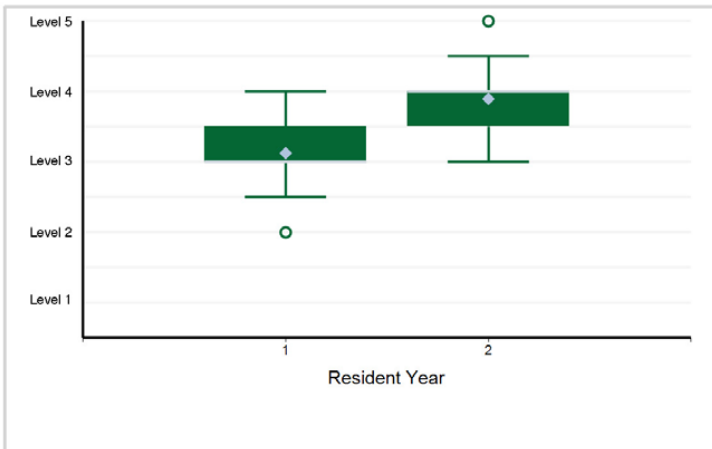

8. Medical Knowledge - Medical Knowledge 2: Regulatory

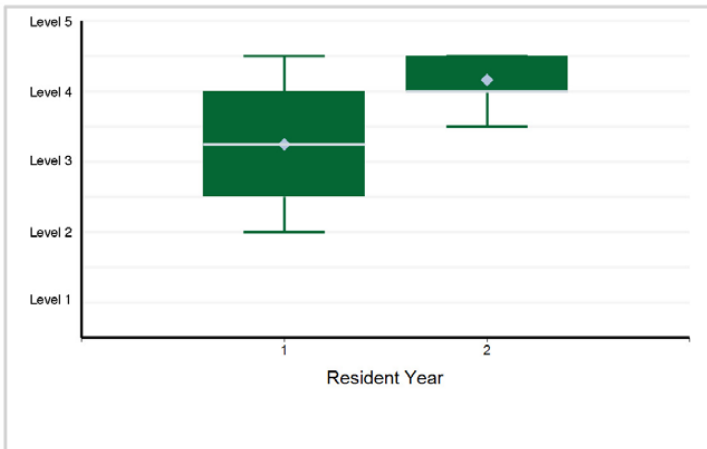

9. Systems-Based Practice - Systems-Based Practice 1: Patient Safety and Quality Improvement

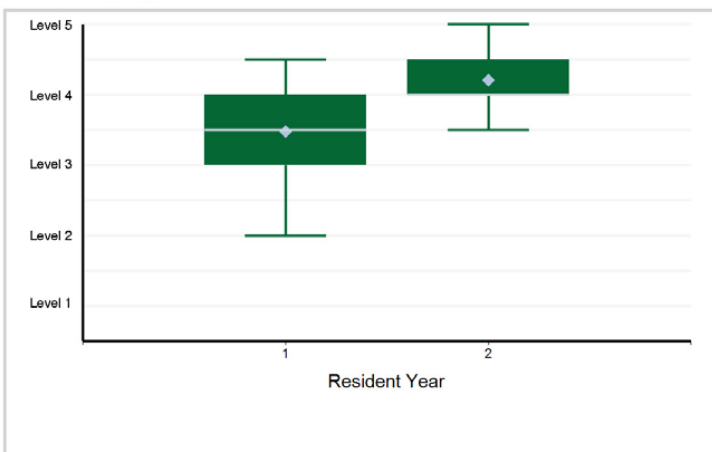

10. Systems-Based Practice - Systems-Based Practice 2: System Navigation for Patient-Centered Care

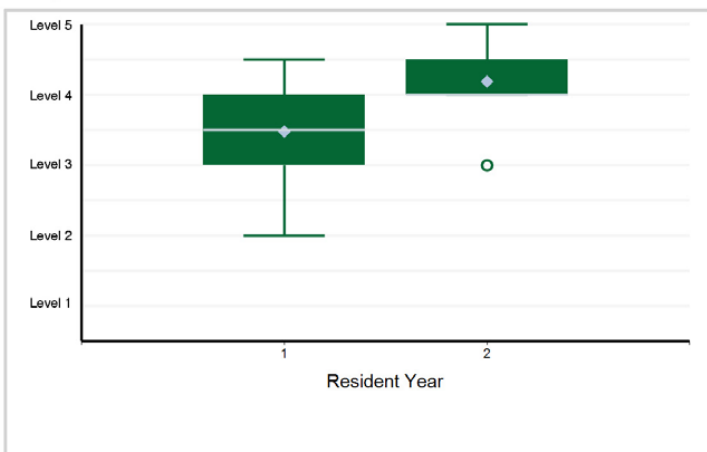

11. Systems-Based Practice - Systems-Based Practice 3: Population Health

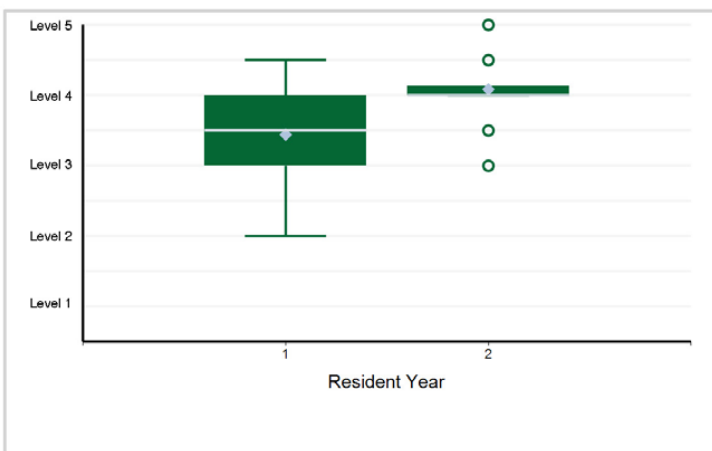

12. Systems-Based Practice - Systems-Based Practice 4: Physician Role in Health Care Systems

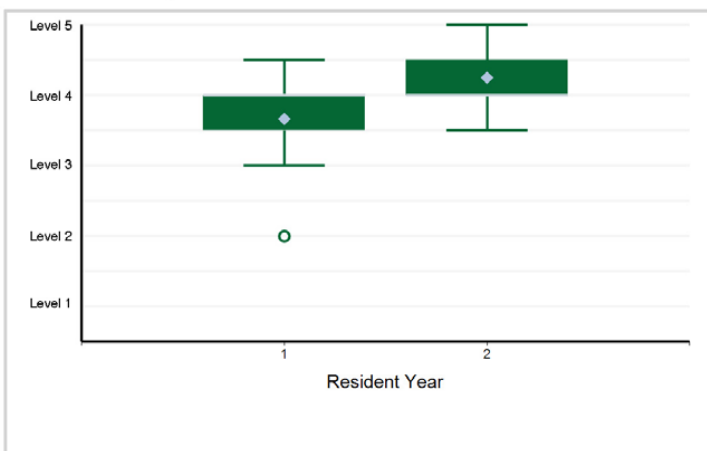

Specialty Box Plot Report - Milestone Evaluation by Resident Year: Year-End 2021-2022

SPECIALTY: Preventive Medicine - Aerospace Medicine

13. Practice-Based Learning and Improvement - Practice-Based Learning and Improvement 1: Evidence-Based and Informed Practice

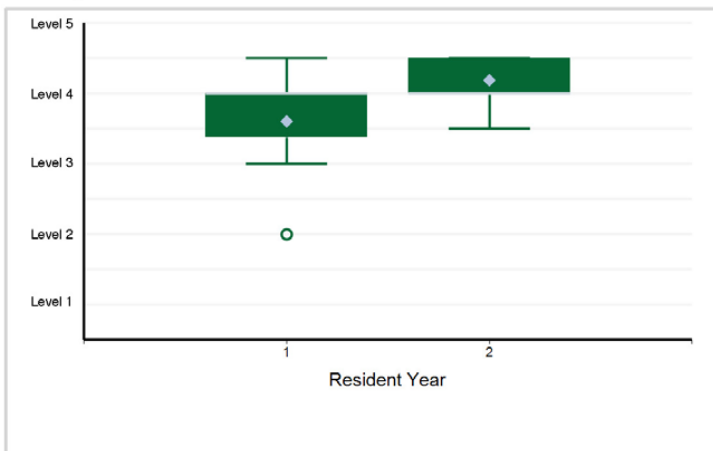

14. Practice-Based Learning and Improvement - Practice-Based Learning and Improvement 2: Reflective Practice and Commitment ...

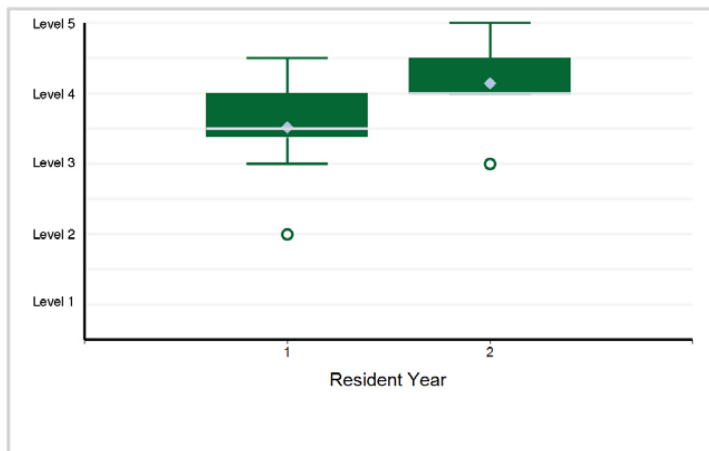

15. Professionalism - Professionalism 1: Professional Behavior and Ethical Principles

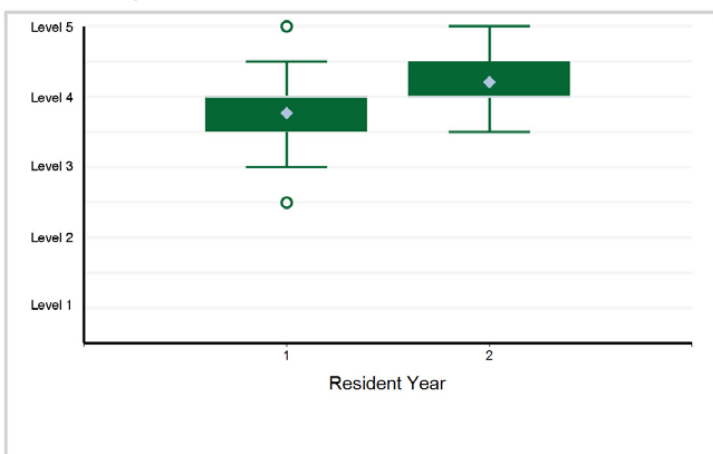

16. Professionalism - Professionalism 2: Accountability/Conscientiousness

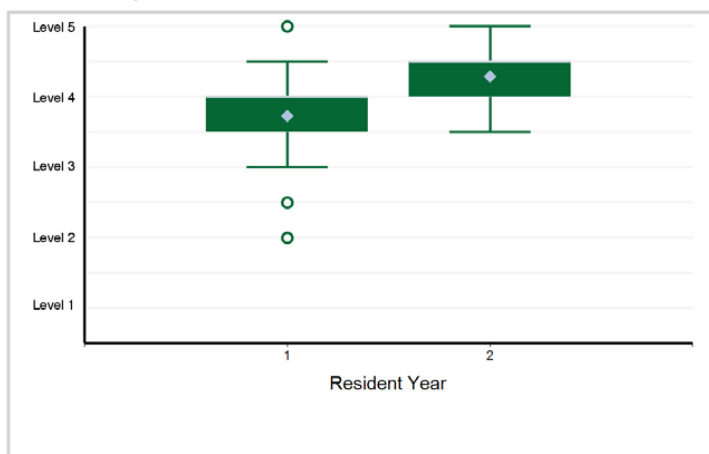

17. Professionalism - Professionalism 3: Self-Awareness and Help-Seeking

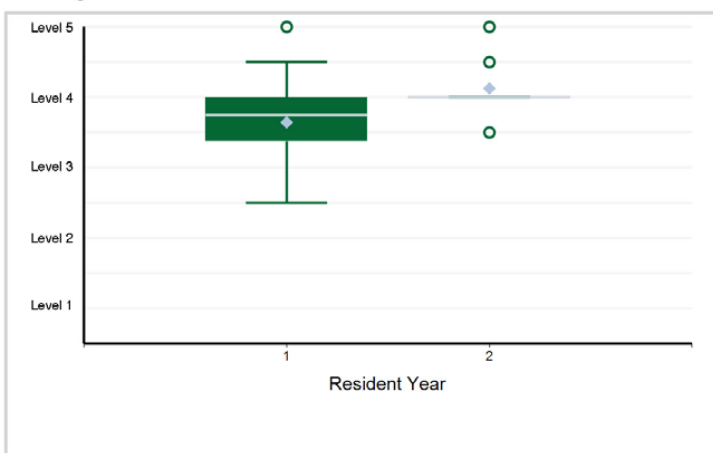

18. Interpersonal and Communication Skills - Interpersonal and Communication Skills 1: Patient- and Family-Centered Communication

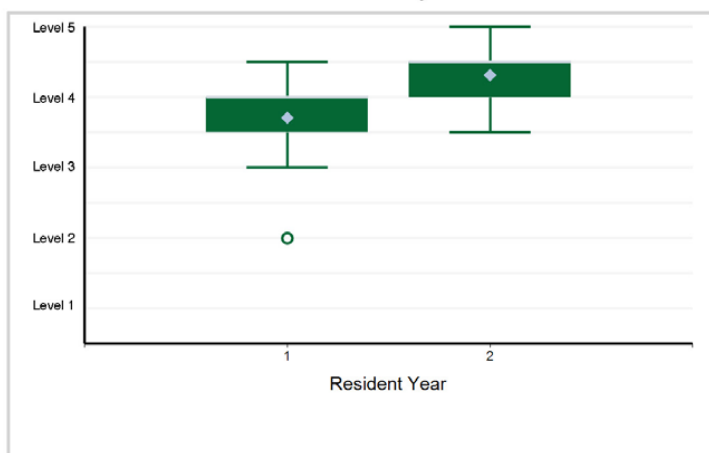

Specialty Box Plot Report - Milestone Evaluation by Resident Year: Year-End 2021-2022

SPECIALTY: Preventive Medicine - Aerospace Medicine

19. Interpersonal and Communication Skills - Interpersonal and Communication Skills 2: Interprofessional and Team Communication

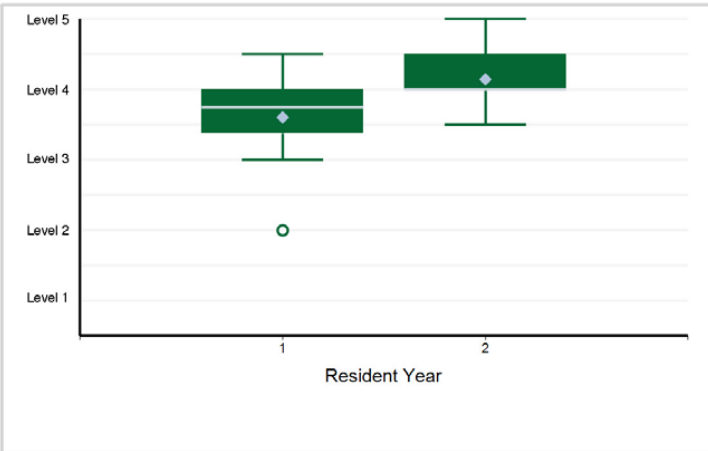

20. Interpersonal and Communication Skills - Interpersonal and Communication Skills 3: Communication within Health Care Systems

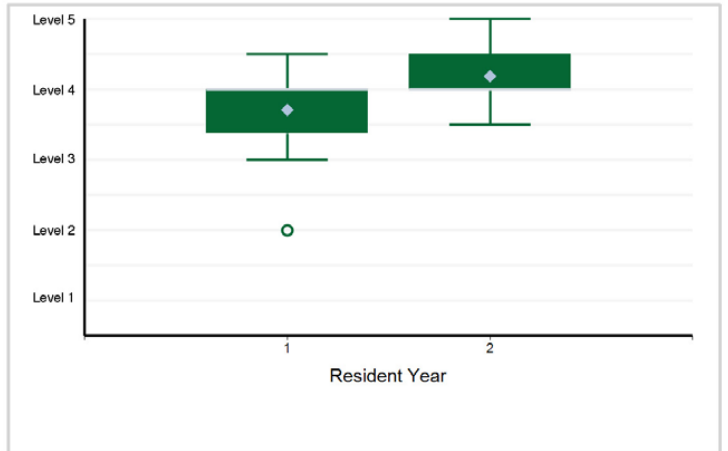

Specialty Box Plot Report - Milestone Evaluation by Resident Year: Year-End 2021-2022

TABLE 121: SPECIALTY: Preventive Medicine - Occupational Medicine

Resident Year	1	2	Total Residents
# of Residents	66	48	114

1. Patient Care - Patient Care 1: History and Physical Examination

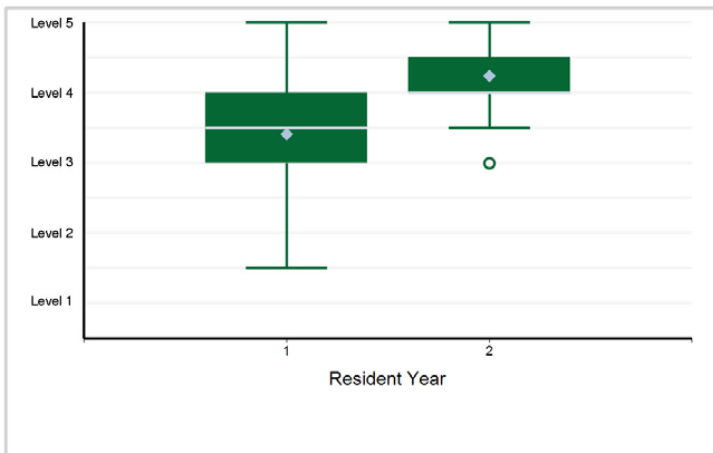

2. Patient Care - Patient Care 2: Clinical Assessment and Management

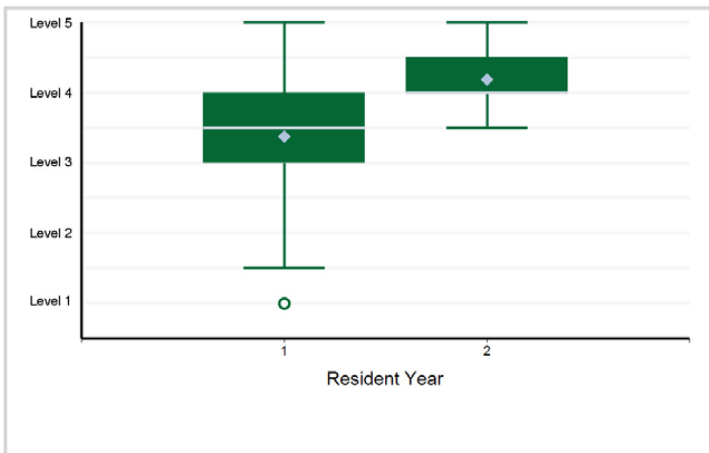

3. Patient Care - Patient Care 3: Worker Health, Well-Being, and Performance Optimization

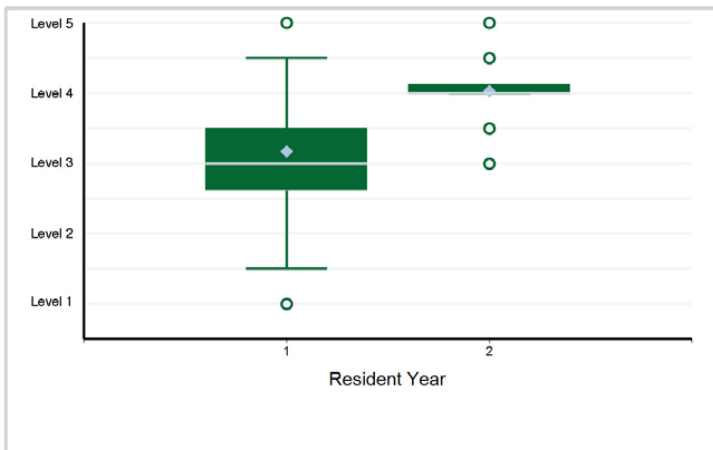

4. Patient Care - Patient Care 4: Fitness for Work (Workers' Compensation, Employment and Certification Exams, Fitness for ...

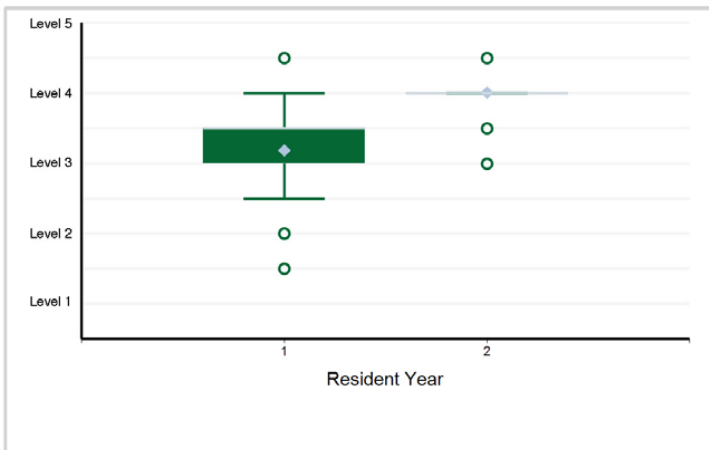

5. Patient Care - Patient Care 5: Toxicology

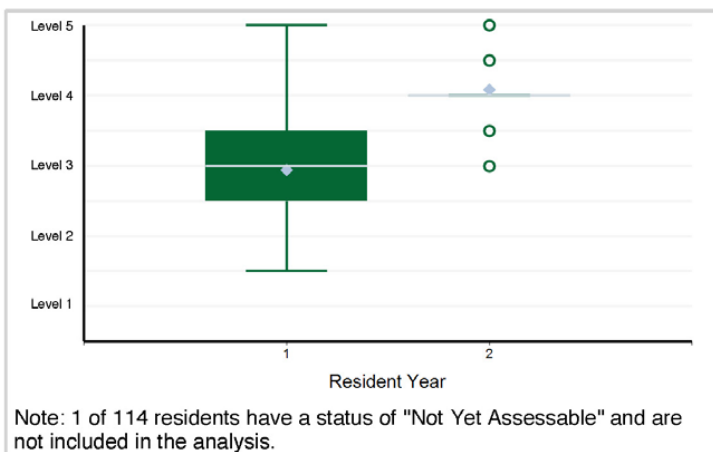

6. Patient Care - Patient Care 6: Surveillance

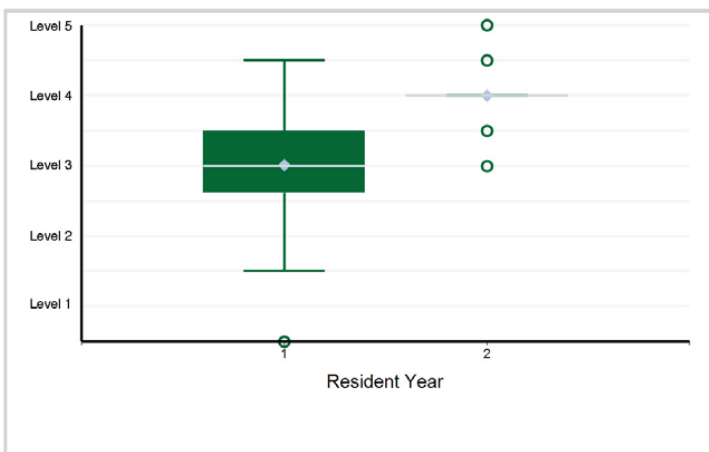

Note: 1 of 114 residents have a status of "Not Yet Assessable" and are not included in the analysis.

Specialty Box Plot Report - Milestone Evaluation by Resident Year: Year-End 2021-2022

SPECIALTY: Preventive Medicine - Occupational Medicine

7. Medical Knowledge - Medical Knowledge 1: Hazard Recognition and Management

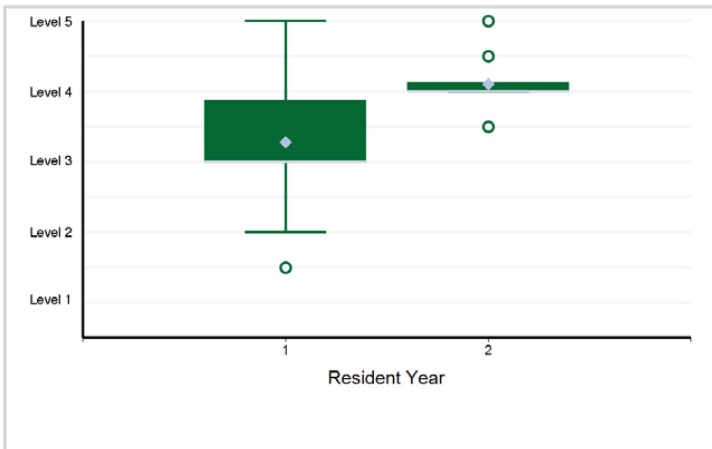

8. Medical Knowledge - Medical Knowledge 2: Biostatistics and Epidemiology

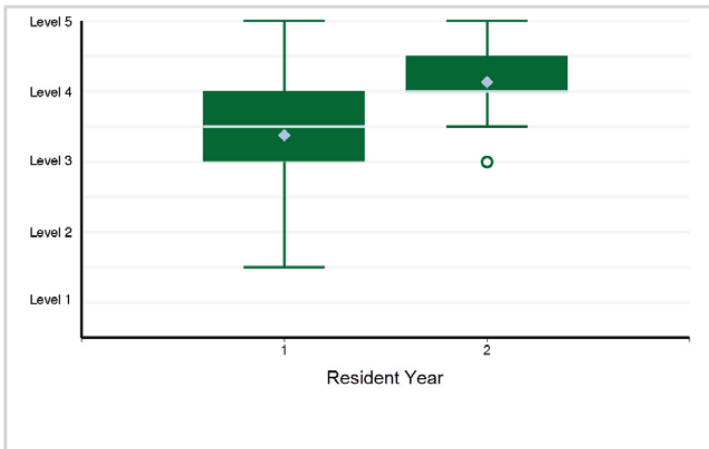

9. Medical Knowledge - Medical Knowledge 3: Regulatory

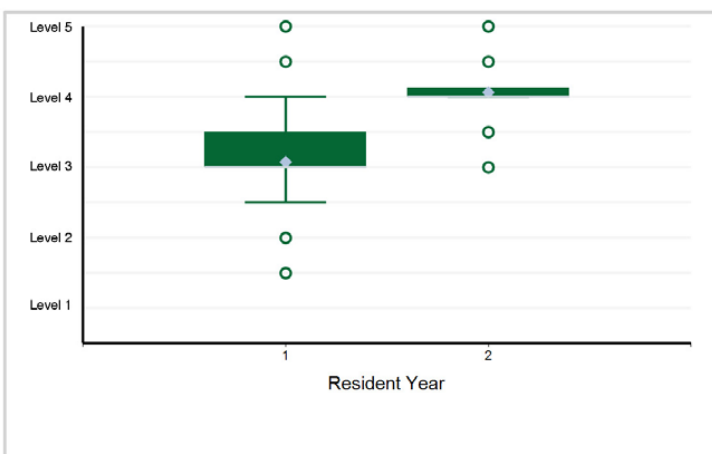

10. Systems-Based Practice - Systems-Based Practice 1: Patient Safety and Quality Improvement

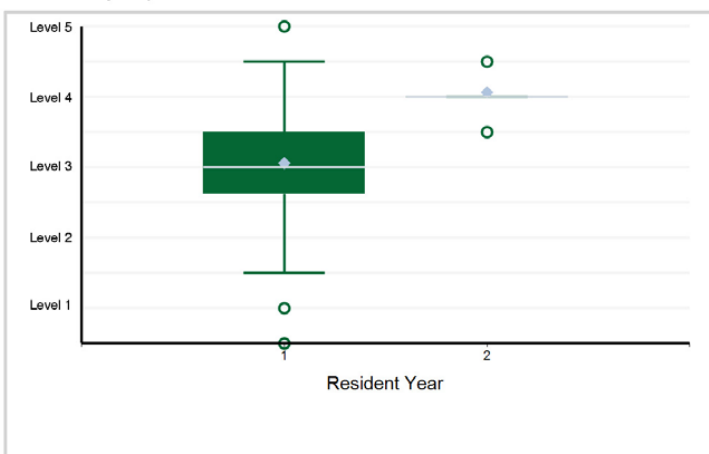

11. Systems-Based Practice - Systems-Based Practice 2: System Navigation for Patient-Centered Care

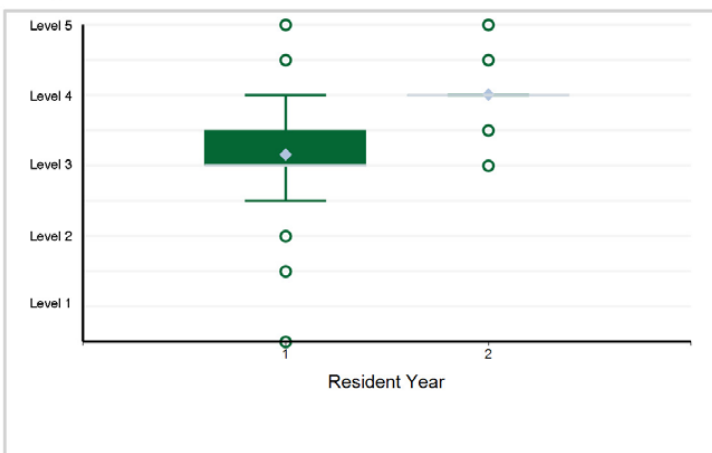

12. Systems-Based Practice - Systems-Based Practice 3: Population Health

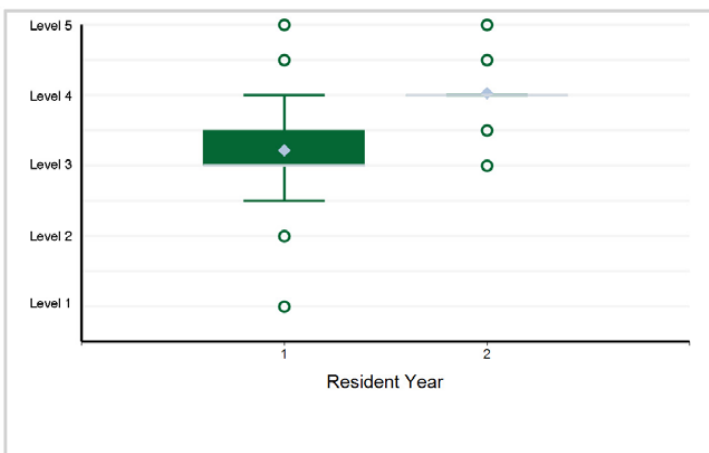

Specialty Box Plot Report - Milestone Evaluation by Resident Year: Year-End 2021-2022

SPECIALTY: Preventive Medicine - Occupational Medicine

13. Systems-Based Practice - Systems-Based Practice 4: Physician Role in Health Care Systems

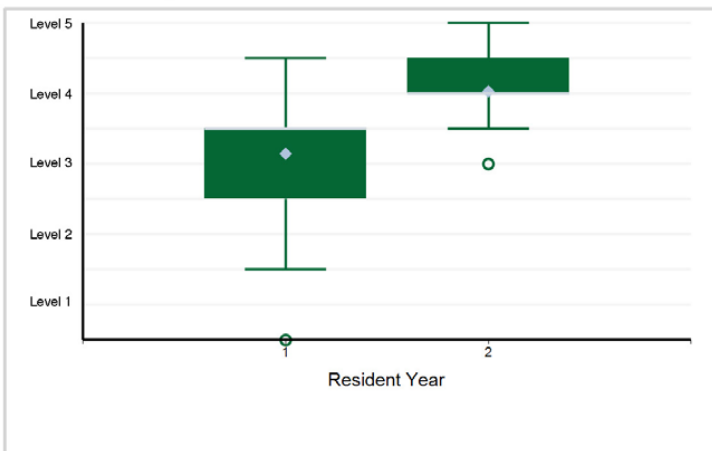

14. Practice-Based Learning and Improvement - Practice-Based Learning and Improvement 1: Evidence-Based and Informed Practice

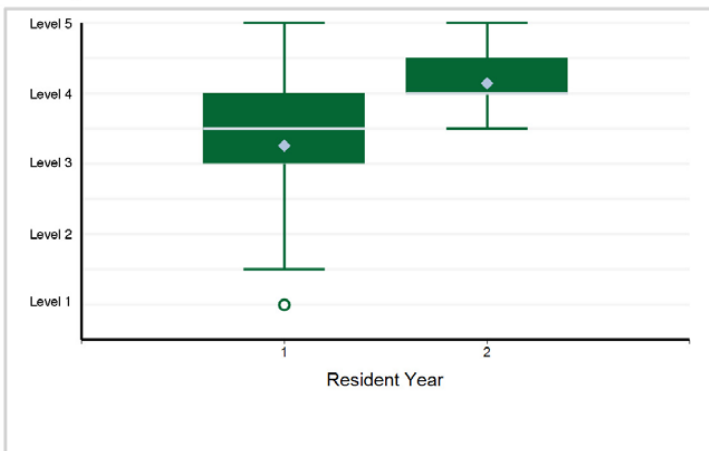

15. Practice-Based Learning and Improvement - Practice-Based Learning and Improvement 2: Reflective Practice and Commitment ...

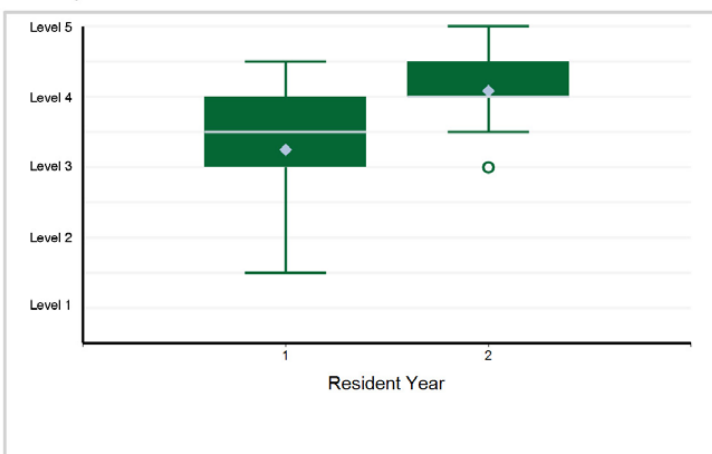

16. Professionalism - Professionalism 1: Professional Behavior and Ethical Principles

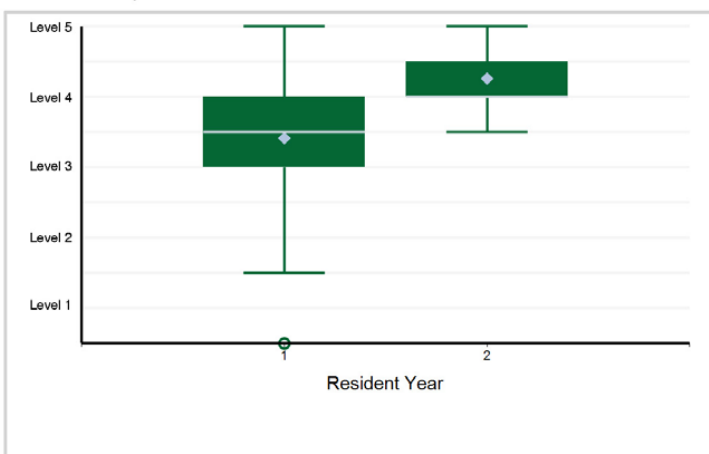

17. Professionalism - Professionalism 2: Accountability/Conscientiousness

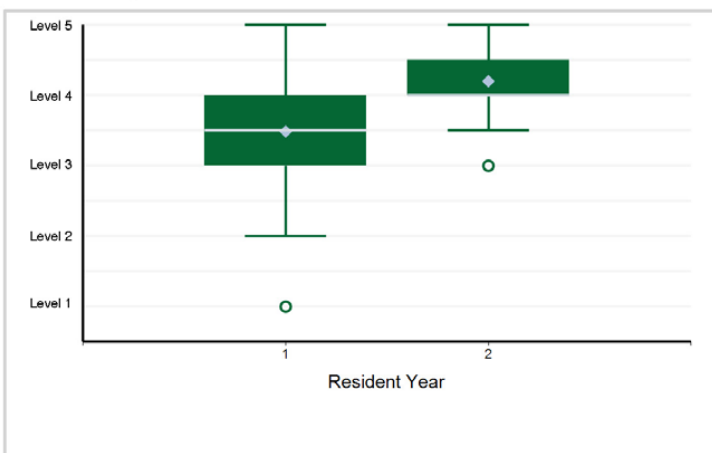

18. Professionalism - Professionalism 3: Self-Awareness and Help-Seeking

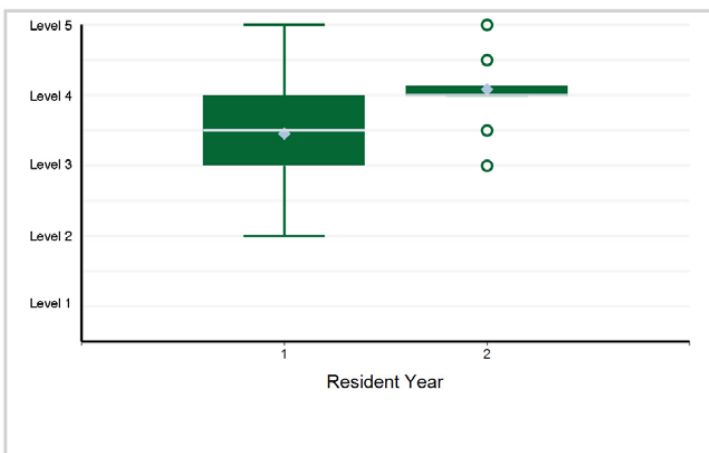

Specialty Box Plot Report - Milestone Evaluation by Resident Year: Year-End 2021-2022

SPECIALTY: Preventive Medicine - Occupational Medicine

19. Interpersonal and Communication Skills - Interpersonal and Communication Skills 1: Patient- and Family-Centered Communication

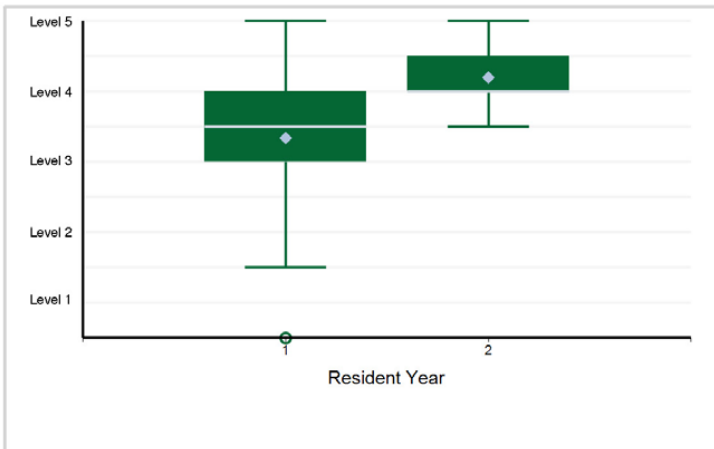

20. Interpersonal and Communication Skills - Interpersonal and Communication Skills 2: Interprofessional and Team Communication

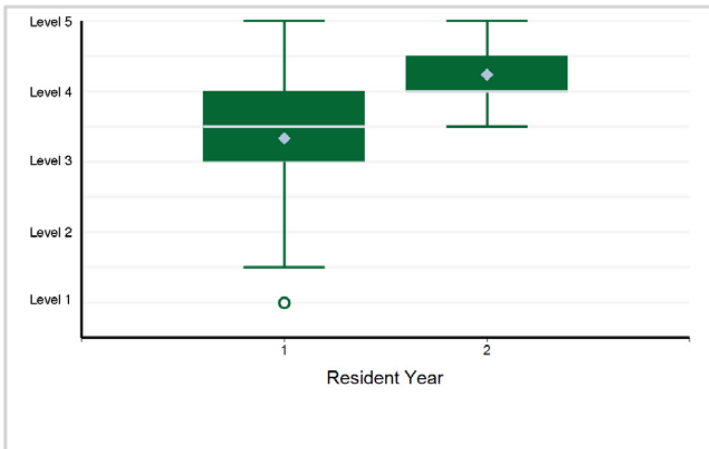

21. Interpersonal and Communication Skills - Interpersonal and Communication Skills 3: Communication within Health Care Systems

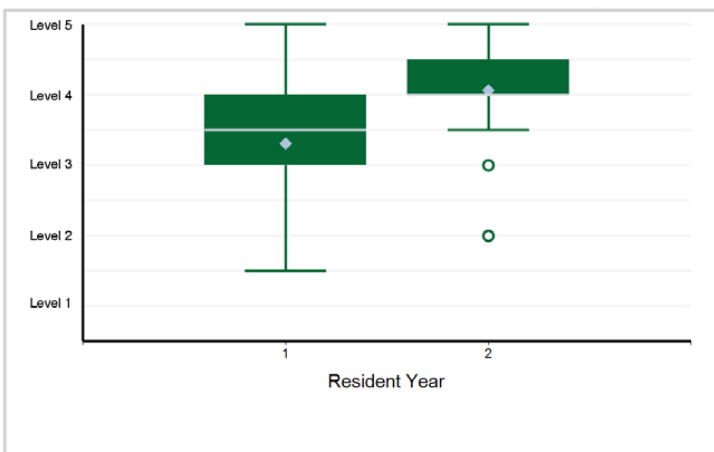

Specialty Box Plot Report - Milestone Evaluation by Resident Year: Year-End 2021-2022

TABLE 122: SPECIALTY: Preventive Medicine - Public Health and General Preventive Medicine

Resident Year	1	2	Total Residents
# of Residents	98	77	175

1. Patient Care - Emergency Preparedness and Response: Apply skills in Emergency Preparedness and Response - Patient Care 1

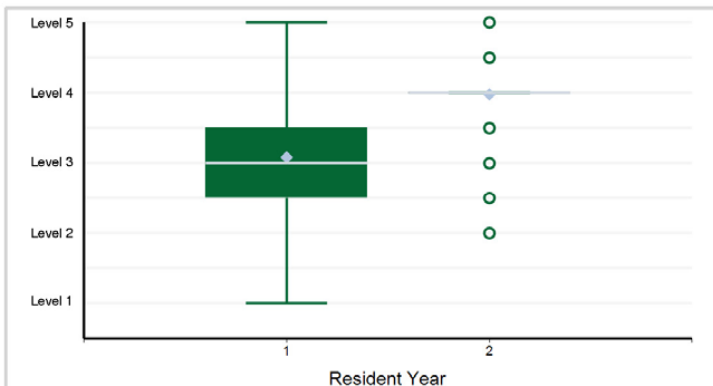

Note: 7 of 175 residents have a status of "Not Yet Rotated" and are not included in the analysis.

2. Patient Care - Community Health: Monitor, diagnose, and investigate community health problems - Patient Care 2

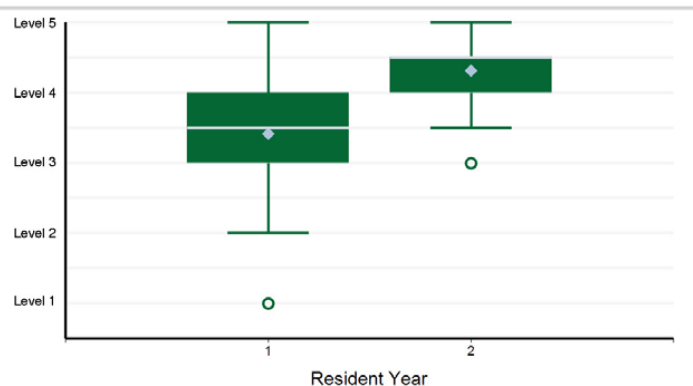

Note: 5 of 175 residents have a status of "Not Yet Rotated" and are not included in the analysis.

3. Patient Care - Inform and Educate: Inform and educate populations about health threats and risks - Patient Care 3

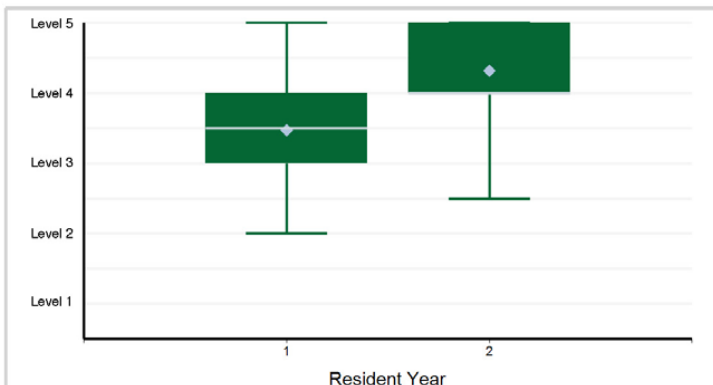

Note: 6 of 175 residents have a status of "Not Yet Rotated" and are not included in the analysis.

4. Patient Care - Policies and Plans: Develop policies and plans to support individual and community health ...

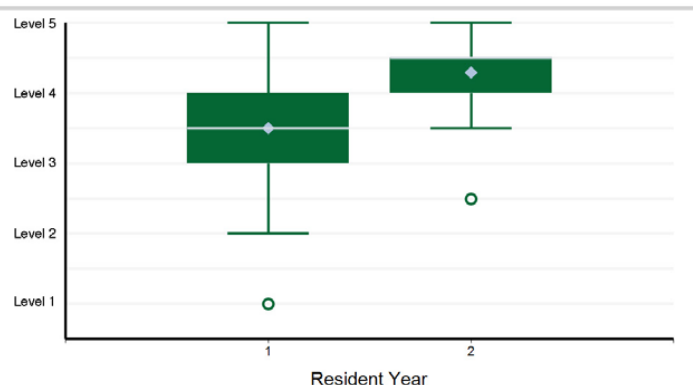

Note: 5 of 175 residents have a status of "Not Yet Rotated" and are not included in the analysis.

5. Patient Care - Evaluating Health Services: Evaluate population-based health services - Patient Care 5

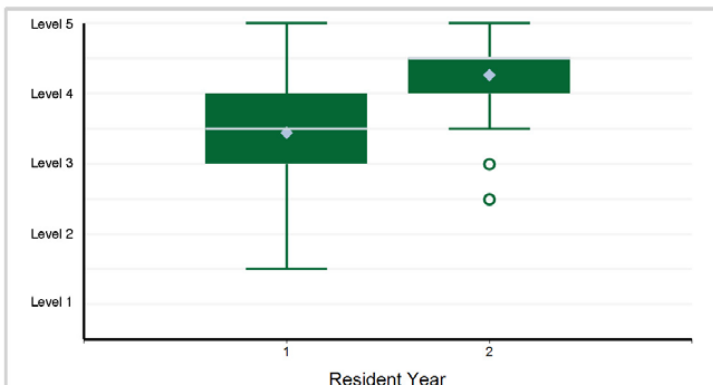

6. Patient Care - Descriptive Epidemiology: Able to characterize the health of a community - Patient Care 6

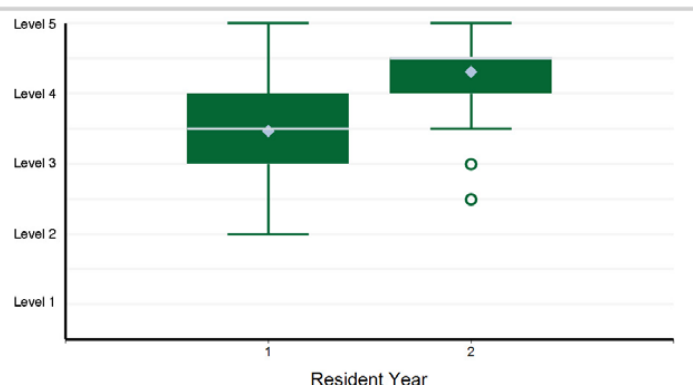

Specialty Box Plot Report - Milestone Evaluation by Resident Year: Year-End 2021-2022

SPECIALTY: Preventive Medicine - Public Health and General Preventive Medicine

7. Patient Care - Analytic Epidemiology: Able to design and conduct an epidemiologic study - Patient Care 7

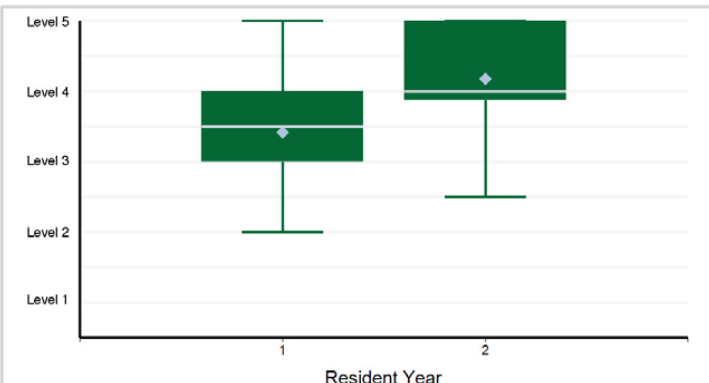

Note: 3 of 175 residents have a status of "Not Yet Rotated" and are not included in the analysis.

8. Patient Care - Disease Outbreak: Investigate and respond to a cluster or outbreak - Patient Care 8

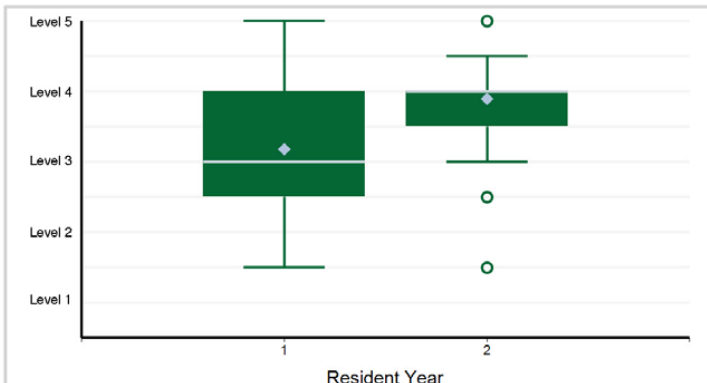

Note: 8 of 175 residents have a status of "Not Yet Rotated" and are not included in the analysis.

9. Patient Care - Surveillance Systems: Design and operate a surveillance system - Patient Care 9

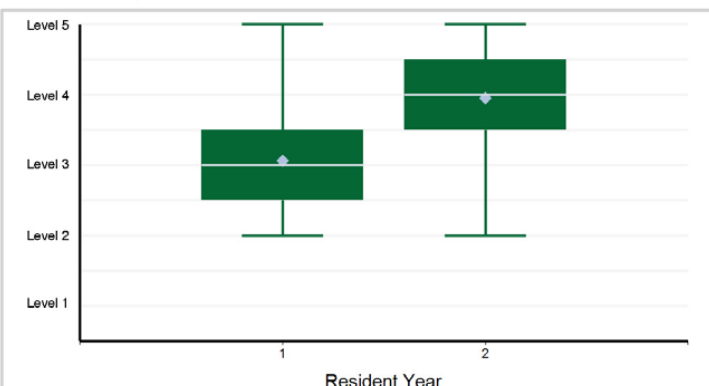

Note: 3 of 175 residents have a status of "Not Yet Rotated" and are not included in the analysis.

10. Patient Care - Clinical Preventive Services (CPS): Analyze evidence regarding the performance of proposed ...

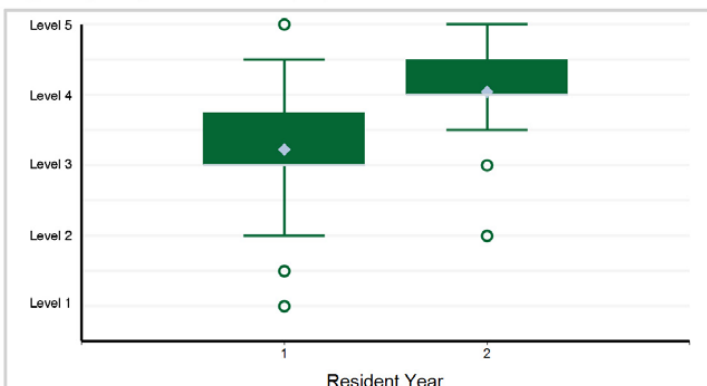

Note: 3 of 175 residents have a status of "Not Yet Rotated" and are not included in the analysis.

11. Patient Care - Conditions of Public Health Significance: Implement appropriate clinical care for individuals ...

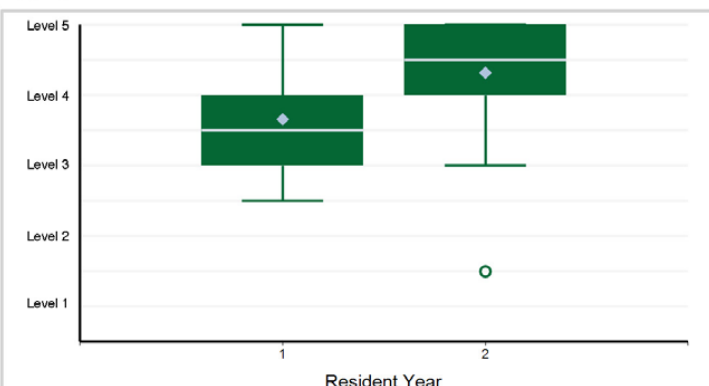

Note: 1 of 175 residents have a status of "Not Yet Rotated" and are not included in the analysis.

12. Patient Care - Preventive Services: Select and provide appropriate evidence-based clinical preventive ...

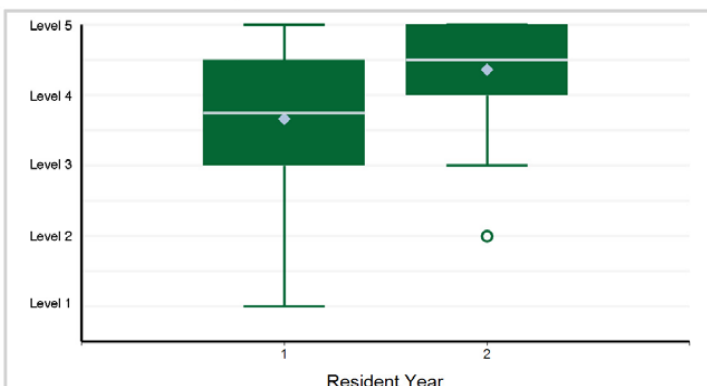

Note: 2 of 175 residents have a status of "Not Yet Rotated" and are not included in the analysis.

Specialty Box Plot Report - Milestone Evaluation by Resident Year: Year-End 2021-2022

SPECIALTY: Preventive Medicine - Public Health and General Preventive Medicine

13. Medical Knowledge - Behavioral Health - Medical Knowledge 1

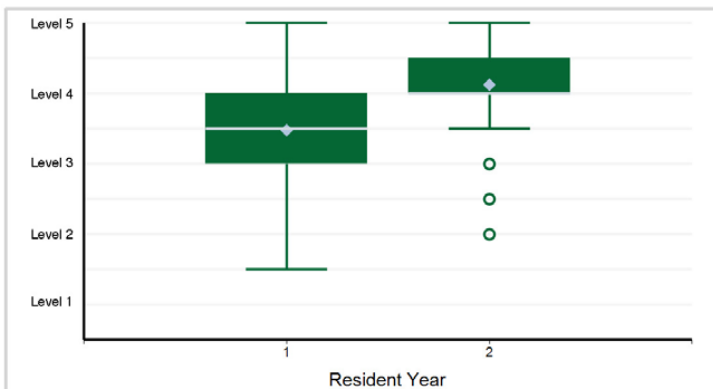

Note: 2 of 175 residents have a status of "Not Yet Rotated" and are not included in the analysis.

14. Medical Knowledge - Environmental Health - Medical Knowledge 2

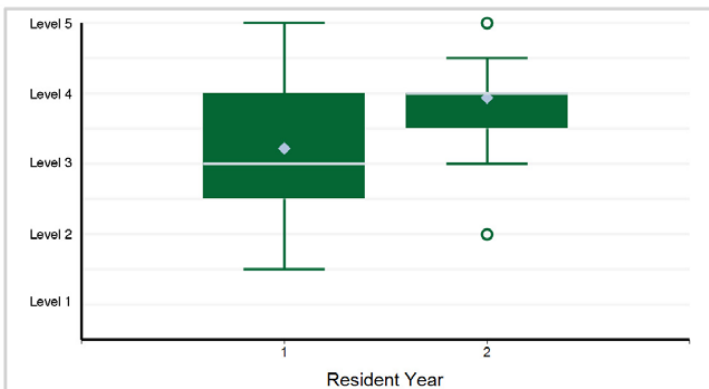

Note: 2 of 175 residents have a status of "Not Yet Rotated" and are not included in the analysis.

15. Medical Knowledge - Biostatistics - Medical Knowledge 3

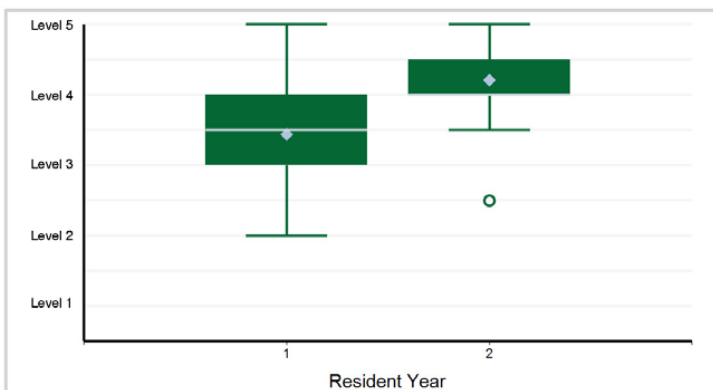

Note: 5 of 175 residents have a status of "Not Yet Rotated" and are not included in the analysis.

16. Systems-Based Practice - Work and coordinate patient care effectively in various health care delivery ...

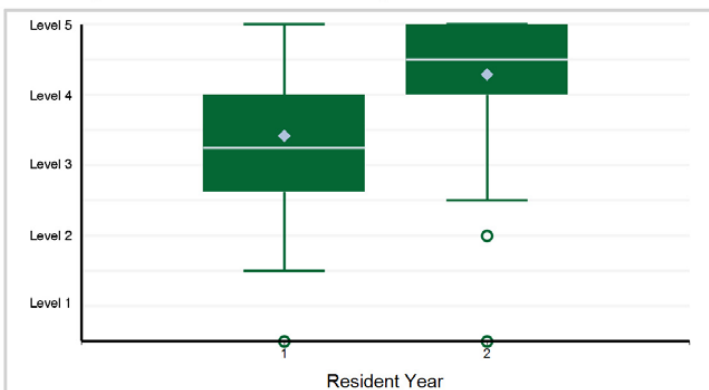

17. Systems-Based Practice - Incorporate considerations of cost awareness and risk-benefit analysis in patient ...

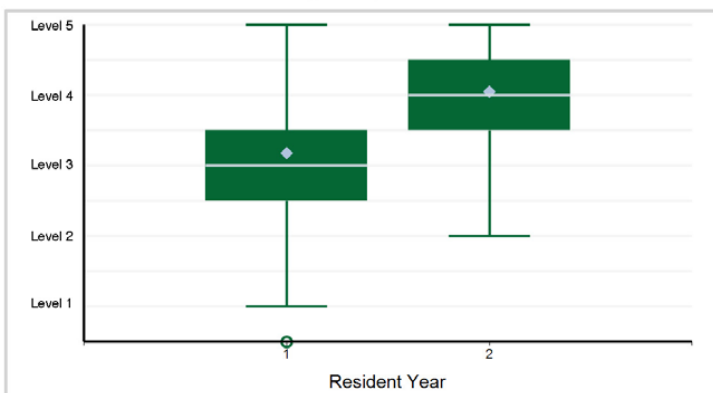

18. Systems-Based Practice - Work in interprofessional teams to enhance patient safety and improve patient ...

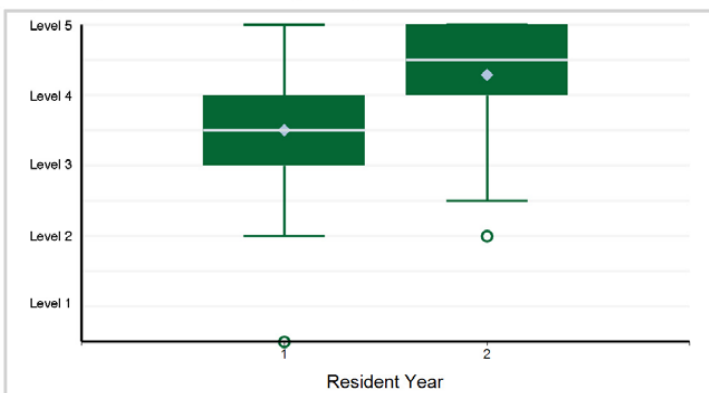

Specialty Box Plot Report - Milestone Evaluation by Resident Year: Year-End 2021-2022

SPECIALTY: Preventive Medicine - Public Health and General Preventive Medicine

19. Practice-Based Learning and Improvement - Identify strengths, deficiencies, and limits in one's knowledge ...

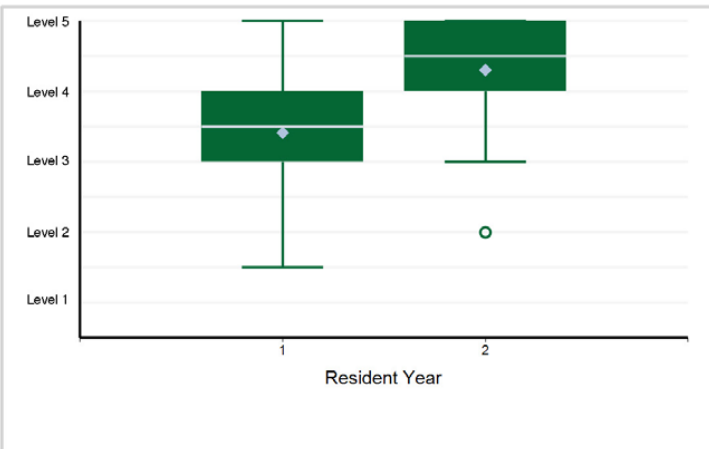

20. Professionalism - Compassion, integrity, and respect for others, as well as sensitivity and responsiveness ...

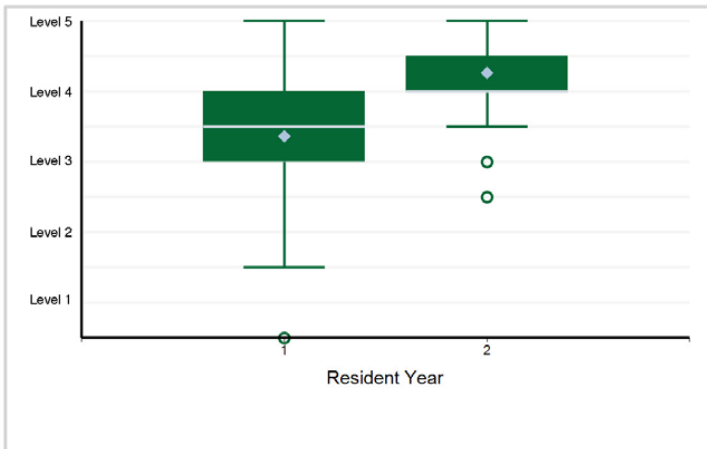

21. Professionalism - Accountability to patients, society and the profession - Professionalism 2

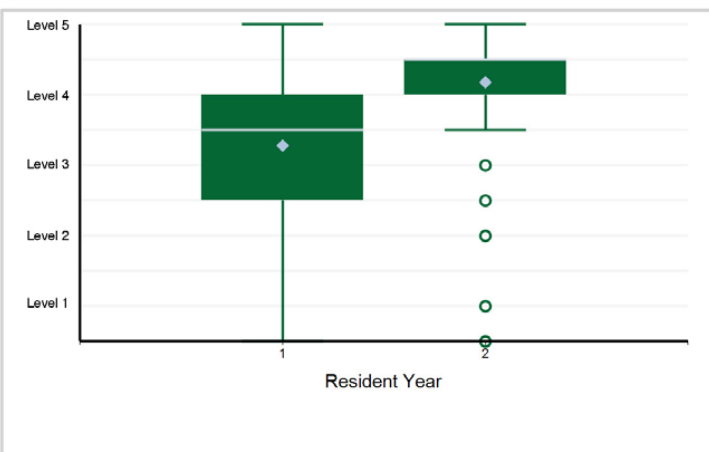

22. Interpersonal and Communication Skills - Communicate effectively with patients, families, and the public, ...

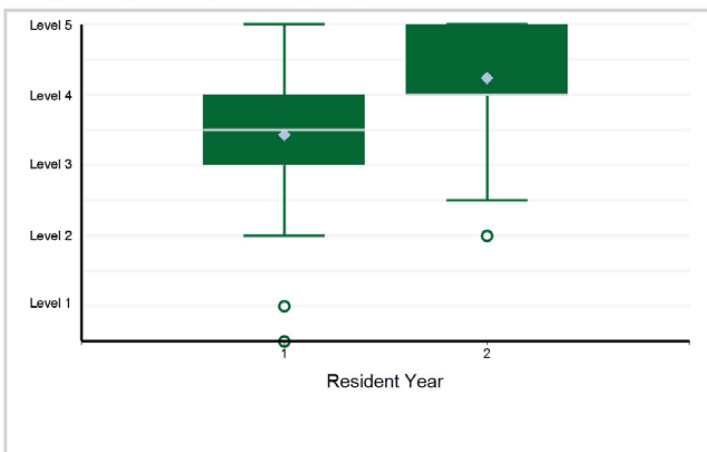

23. Interpersonal and Communication Skills - Maintain comprehensive, timely and legible medical records, ...

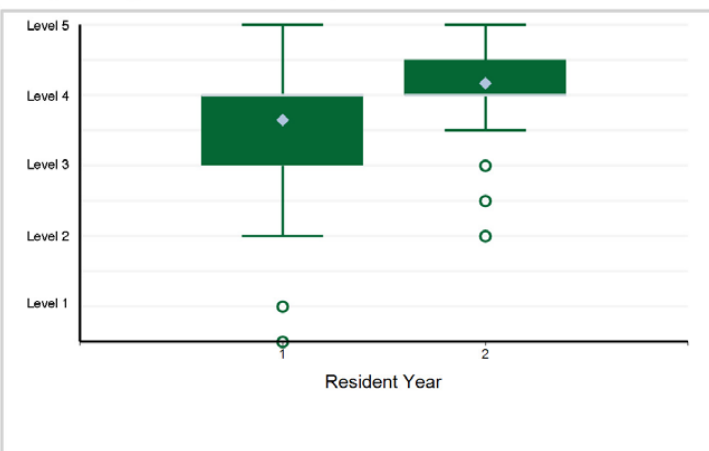

Specialty Box Plot Report - Milestone Evaluation by Resident Year: Year-End 2021-2022

TABLE 123: SPECIALTY: **Psychiatry**

Resident Year	1	2	3	4	Total Residents*
# of Residents	2,064	2,022	1,910	1,374	7,370

*Note: There are 1 residents with an incomplete milestone evaluation that are excluded from the box plots below.

1. Patient Care - Patient Care 1: Psychiatric Evaluation A: Gathers and organizes findings from the patient ...

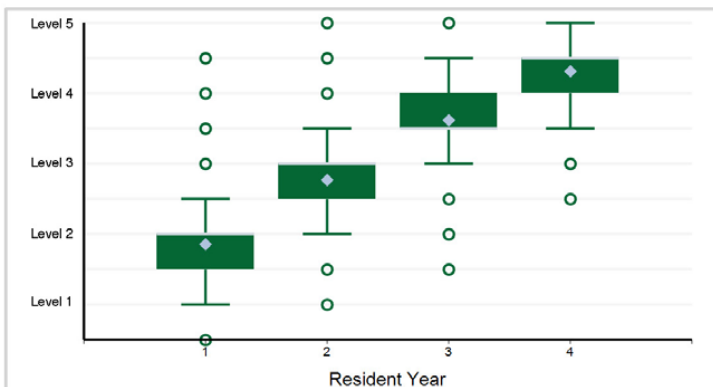

Note: 11 of 7,369 residents have a status of "Not Yet Assessable" and are not included in the analysis.

2. Patient Care - Patient Care 2: Psychiatric Formulation and Differential Diagnosis A: Organizes and summarizes ...

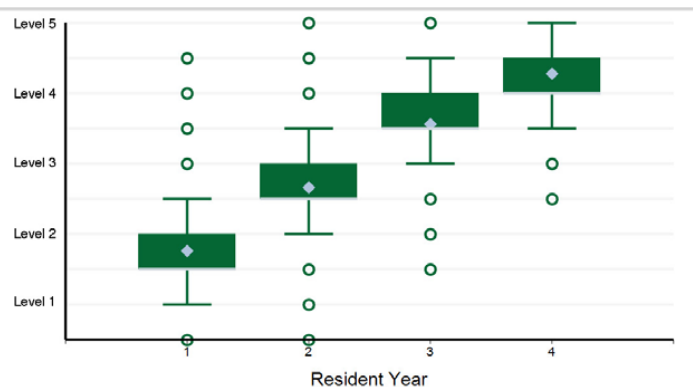

Note: 12 of 7,369 residents have a status of "Not Yet Assessable" and are not included in the analysis.

3. Patient Care - Patient Care 3: Treatment Planning and Management A: Creates treatment plan B: Monitors ...

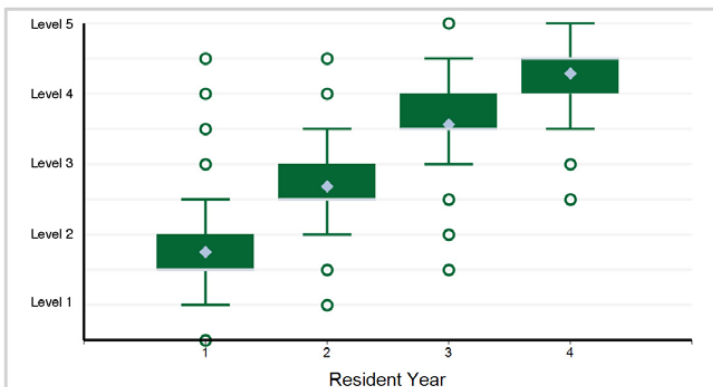

Note: 12 of 7,369 residents have a status of "Not Yet Assessable" and are not included in the analysis.

4. Patient Care - Patient Care 4: Psychotherapy A: Establishes therapeutic alliance and manages boundaries ...

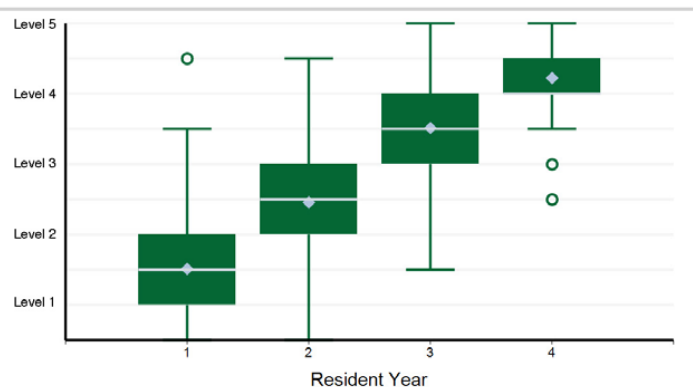

Note: 82 of 7,369 residents have a status of "Not Yet Assessable" and are not included in the analysis.

5. Patient Care - Patient Care 5: Somatic Therapies (including Psychopharmacology and Neurostimulation ...

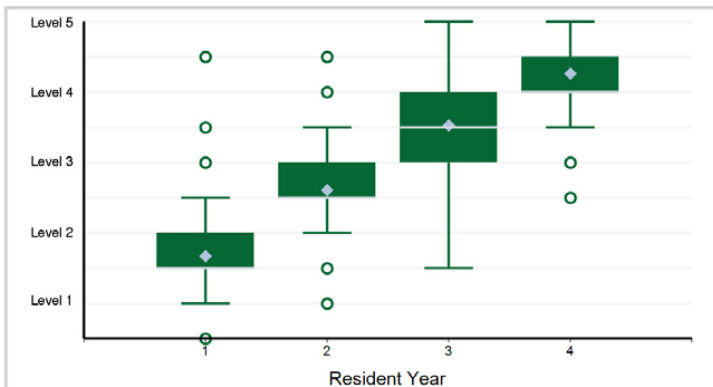

Note: 14 of 7,369 residents have a status of "Not Yet Assessable" and are not included in the analysis.

6. Patient Care - Patient Care 6: Clinical Consultation

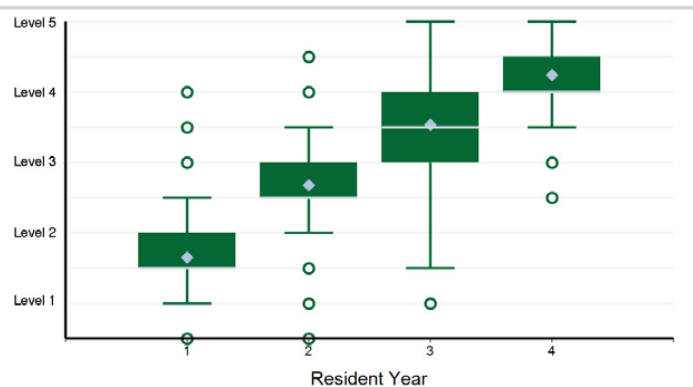

Note: 61 of 7,369 residents have a status of "Not Yet Assessable" and are not included in the analysis.

Specialty Box Plot Report - Milestone Evaluation by Resident Year: Year-End 2021-2022

SPECIALTY: Psychiatry

7. Medical Knowledge - Medical Knowledge 1: Development through the Life Cycle (including the Impact of Psychopathology on ...

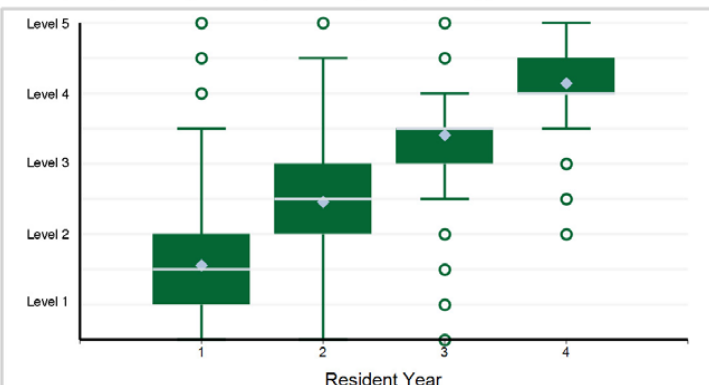

Note: 74 of 7,369 residents have a status of "Not Yet Assessable" and are not included in the analysis.

8. Medical Knowledge - Medical Knowledge 2: Psychopathology (includes Knowledge of Diagnostic Criteria, ...

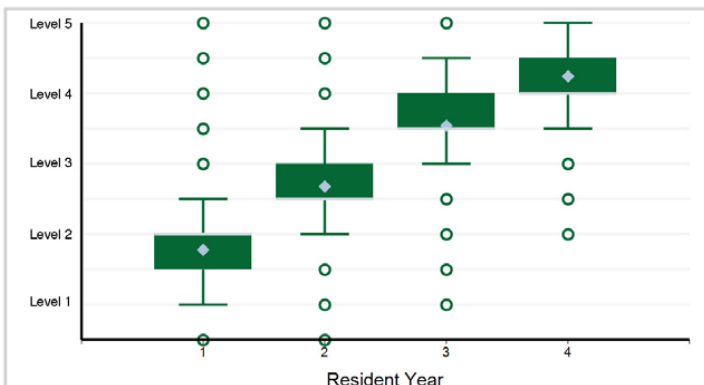

Note: 12 of 7,369 residents have a status of "Not Yet Assessable" and are not included in the analysis.

9. Medical Knowledge - Medical Knowledge 3: Clinical Neuroscience (includes Knowledge of Neurology, Neuropsychiatry, ...

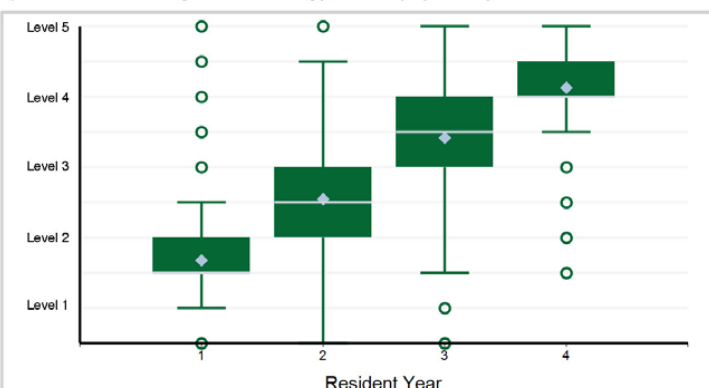

Note: 32 of 7,369 residents have a status of "Not Yet Assessable" and are not included in the analysis.

10. Medical Knowledge - Medical Knowledge 4: Psychotherapy A: Fundamentals B: Practice and indications C: Evidence base

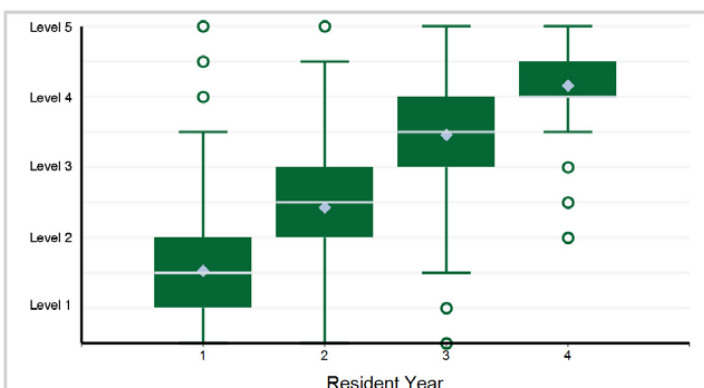

Note: 80 of 7,369 residents have a status of "Not Yet Assessable" and are not included in the analysis.

11. Systems-Based Practice - Systems-Based Practice 1: Patient Safety and Quality Improvement A: Analyzes ...

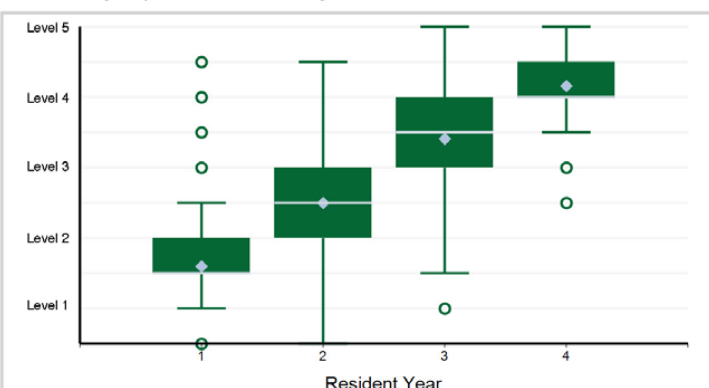

12. Systems-Based Practice - Systems-Based Practice 2: System Navigation for Patient-Centered Care A: Coordinates ...

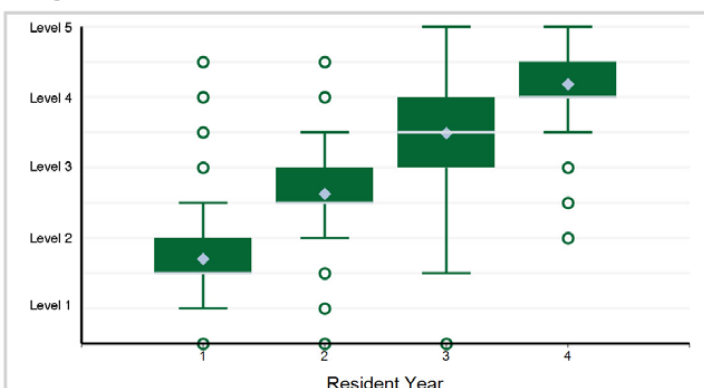

Specialty Box Plot Report - Milestone Evaluation by Resident Year: Year-End 2021-2022

SPECIALTY: **Psychiatry**

13. Systems-Based Practice - Systems-Based Practice 3: Physician Role in Health Care Systems A: Understanding ...

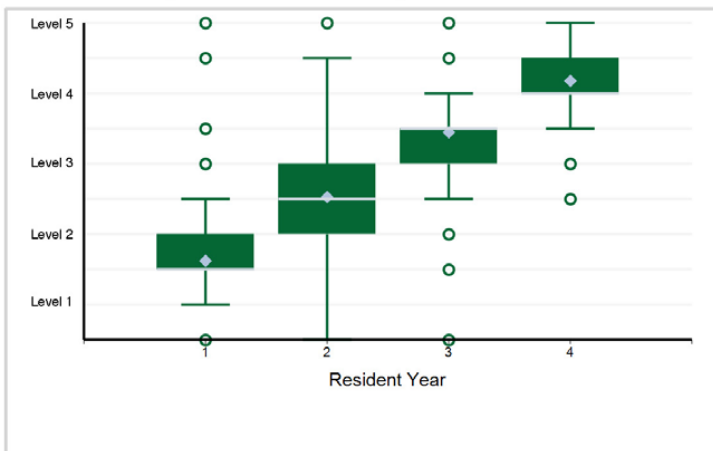

14. Practice-Based Learning and Improvement - Practice-Based Learning and Improvement 1: Evidence-Based and Informed Practice

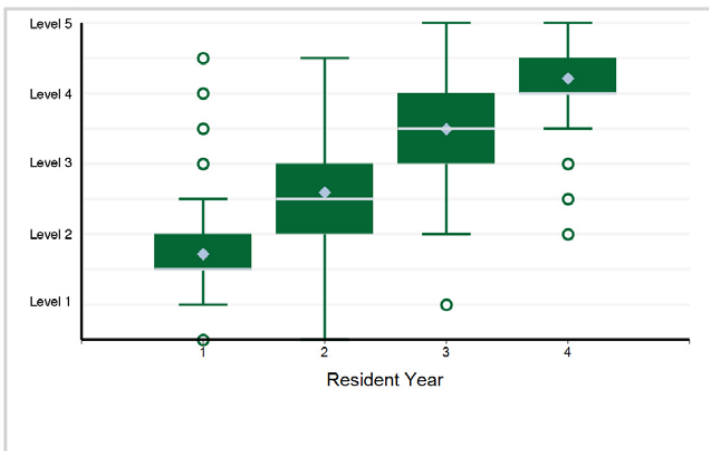

15. Practice-Based Learning and Improvement - Practice-Based Learning and Improvement 2: Reflective Practice and Commitment ...

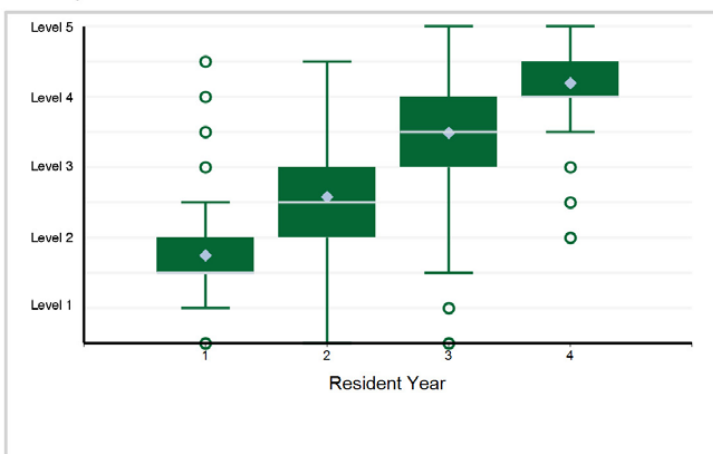

16. Professionalism - Professionalism 1: Professional Behavior and Ethical Principles

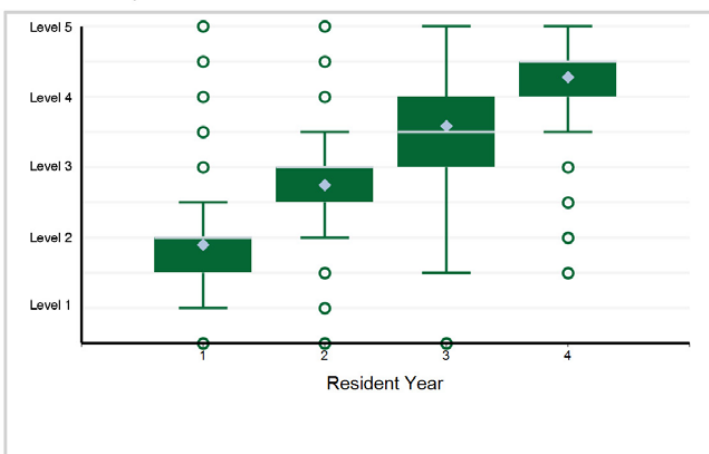

17. Professionalism - Professionalism 2: Accountability/Conscientiousness

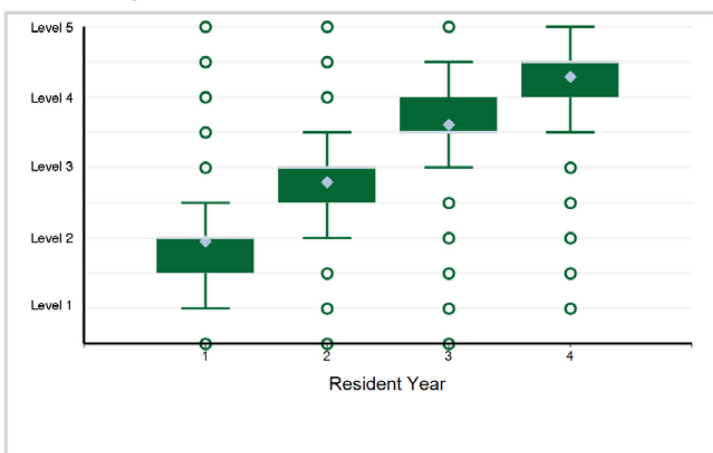

18. Professionalism - Professionalism 3: Well-Being

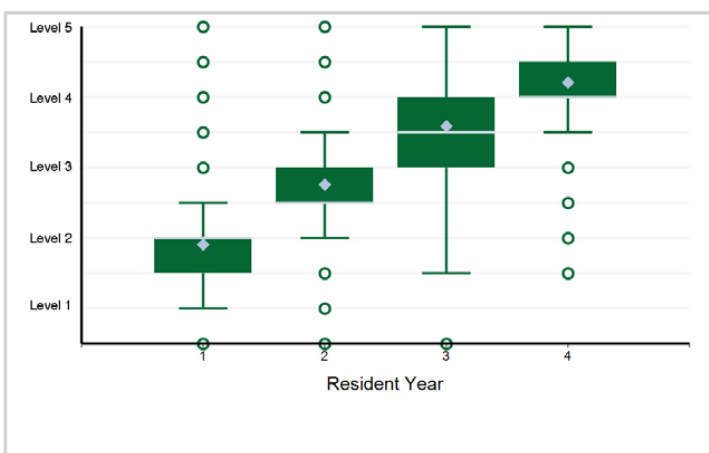

Specialty Box Plot Report - Milestone Evaluation by Resident Year: Year-End 2021-2022

SPECIALTY: **Psychiatry**

19. Interpersonal and Communication Skills - Interpersonal and Communication Skills 1: Patient- and Family-Centered Communication

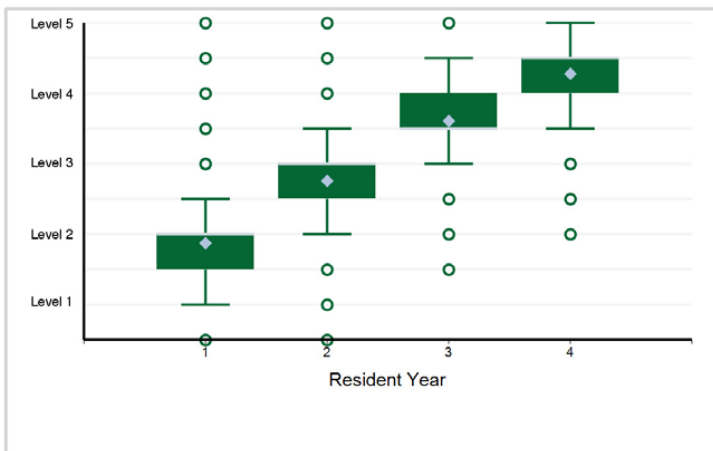

20. Interpersonal and Communication Skills - Interpersonal and Communication Skills 2: Interprofessional and Team Communication

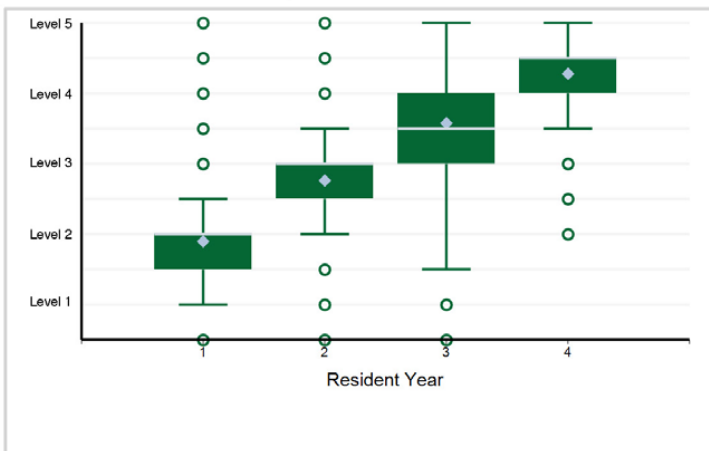

21. Interpersonal and Communication Skills - Interpersonal and Communication Skills 3: Communication within Health Care Systems

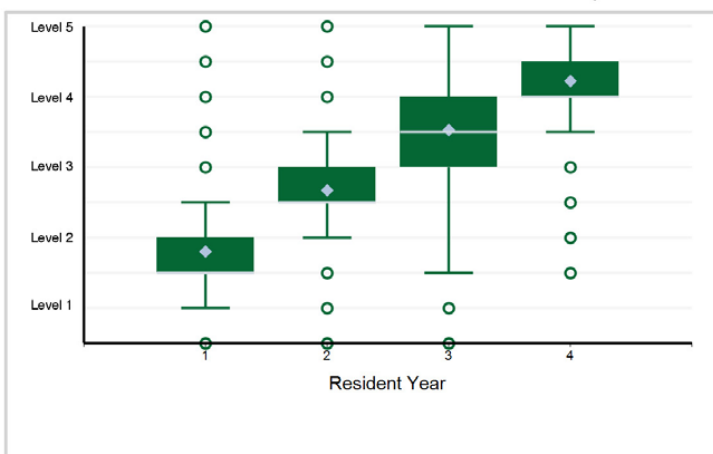

Specialty Box Plot Report - Milestone Evaluation by Resident Year: Year-End 2021-2022

TABLE 124: SUBSPECIALTY: **Addiction Medicine (multidisciplinary, Psychiatry)**

Resident Year	1	Total Residents
# of Residents	182	182

1. Patient Care - 1: Screening, Evaluation, Differential Diagnosis, and Case Formulation of the Patient with or at Risk of ...

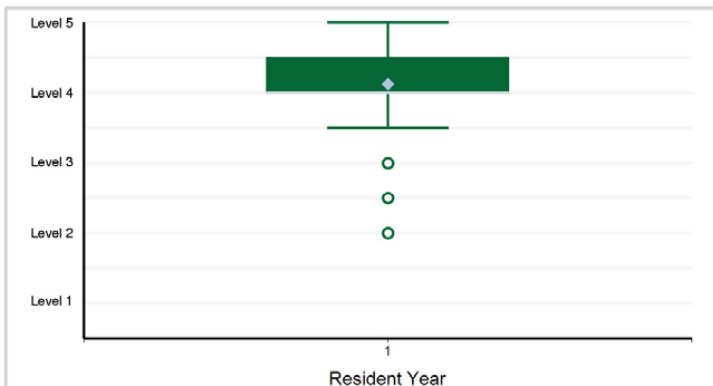

Note: 1 of 182 residents have a status of "Not Yet Assessable" and are not included in the analysis.

2. Patient Care - 2: Pharmacologic and Non-Pharmacologic Treatment for Substance Use and Addictive Disorders

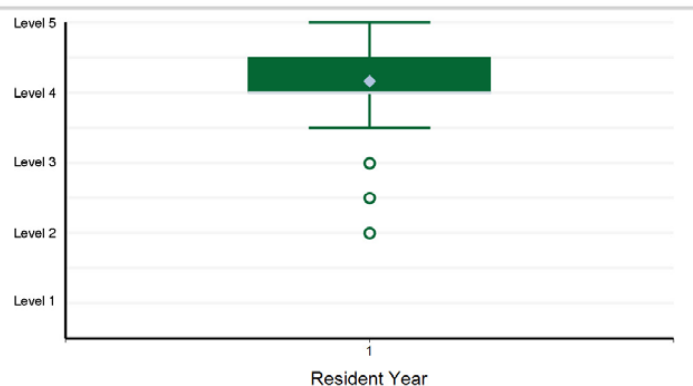

Note: 2 of 182 residents have a status of "Not Yet Assessable" and are not included in the analysis.

3. Medical Knowledge - 1: Neuroscience of Substance Use and Addictive Disorders

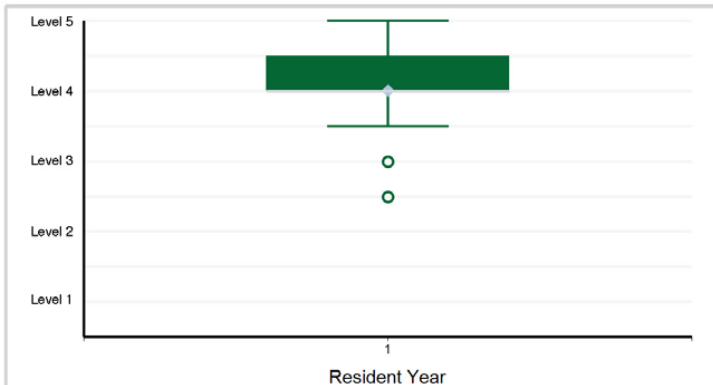

Note: 3 of 182 residents have a status of "Not Yet Assessable" and are not included in the analysis.

4. Medical Knowledge - 2: Epidemiology and Clinical Presentation of Substance Use and Addictive Disorders

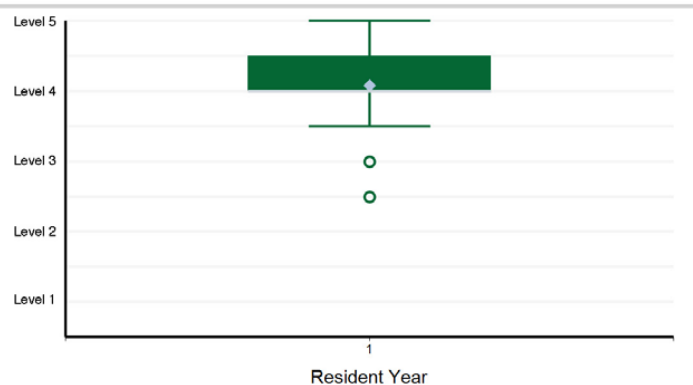

Note: 2 of 182 residents have a status of "Not Yet Assessable" and are not included in the analysis.

5. Medical Knowledge - 3: Treatment Modalities and Interventions in Diverse Patient Populations

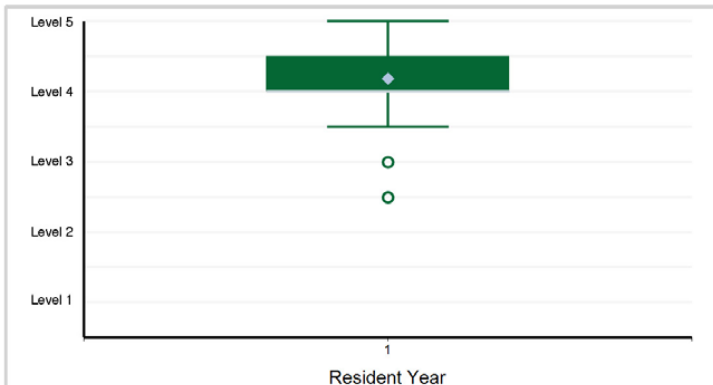

Note: 1 of 182 residents have a status of "Not Yet Assessable" and are not included in the analysis.

6. Systems-Based Practice - 1: Patient Safety and Quality Improvement in Addiction Medicine

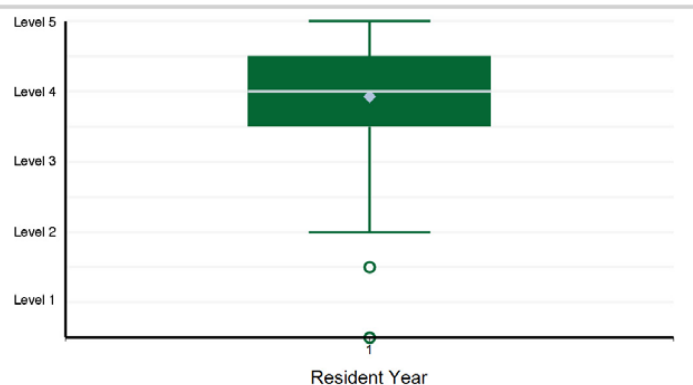

Specialty Box Plot Report - Milestone Evaluation by Resident Year: Year-End 2021-2022

SUBSPECIALTY: **Addiction Medicine (multidisciplinary, Psychiatry)**

7. Systems-Based Practice - 2: System Navigation for Patient-Centered Care in Addiction Medicine

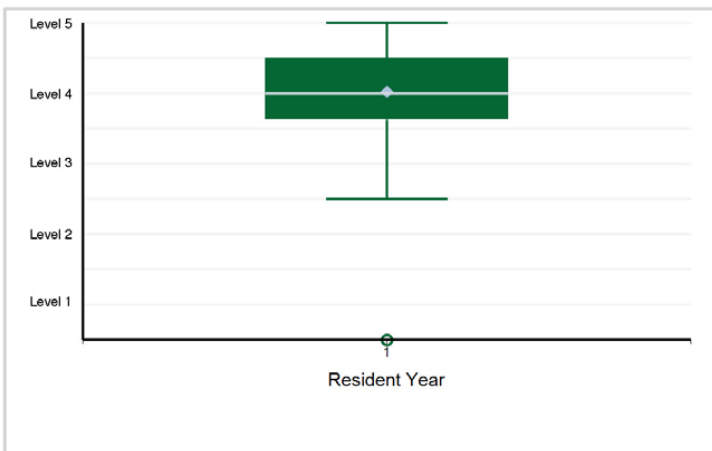

8. Systems-Based Practice - 3: The Addiction Medicine Physician Role in Health Care Systems

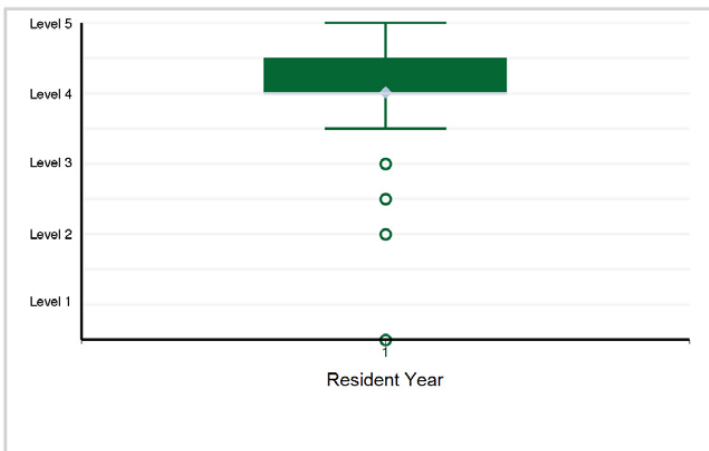

9. Practice-Based Learning and Improvement - 1: Evidence-Based and Informed Practice

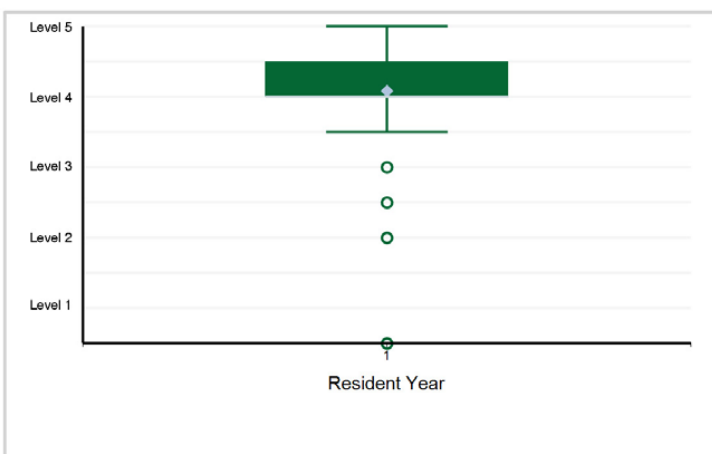

10. Practice-Based Learning and Improvement - 2: Reflective Practice and Commitment to Personal Growth in Addiction Medicine

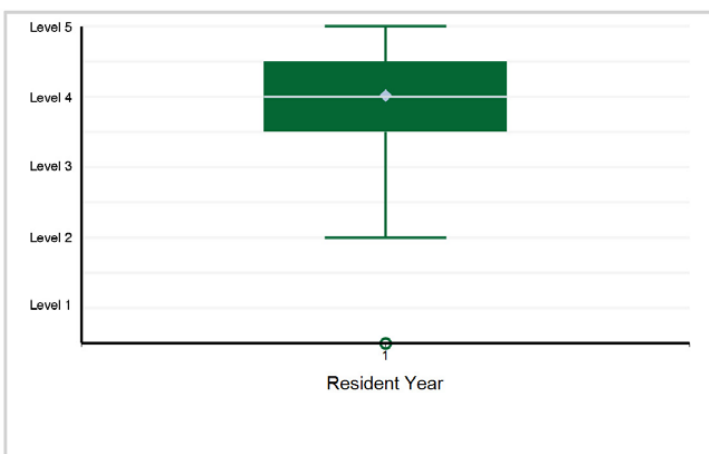

11. Professionalism - 1: Professional Behavior and Ethical Principles

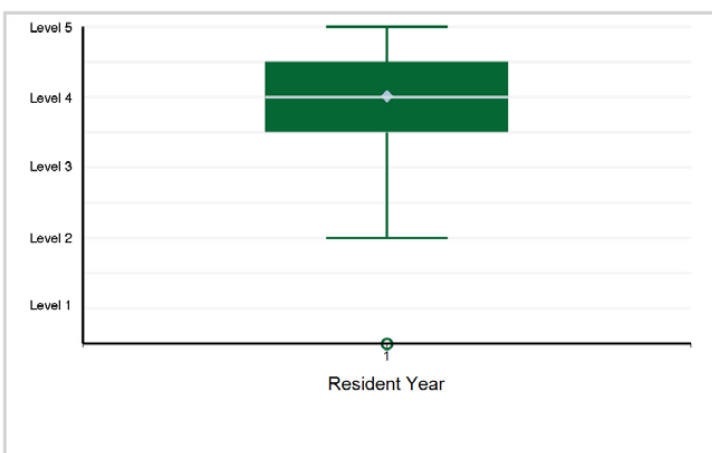

12. Professionalism - 2: Accountability/Conscientiousness in Addiction Medicine

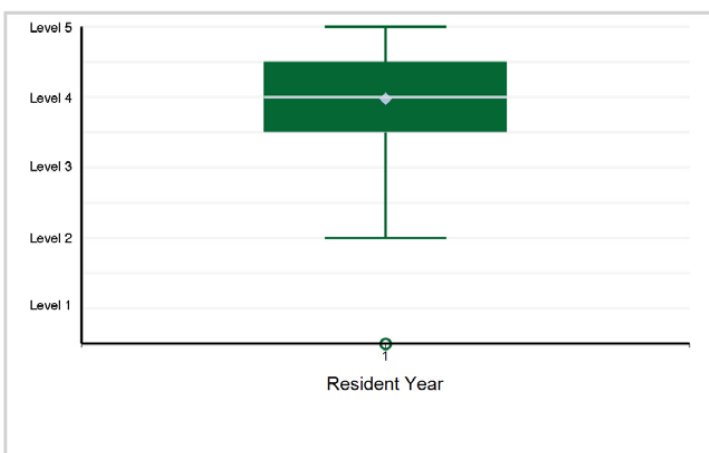

Specialty Box Plot Report - Milestone Evaluation by Resident Year: Year-End 2021-2022

SUBSPECIALTY: **Addiction Medicine (multidisciplinary, Psychiatry)**

13. Professionalism - 3: Self-Awareness and Help-Seeking

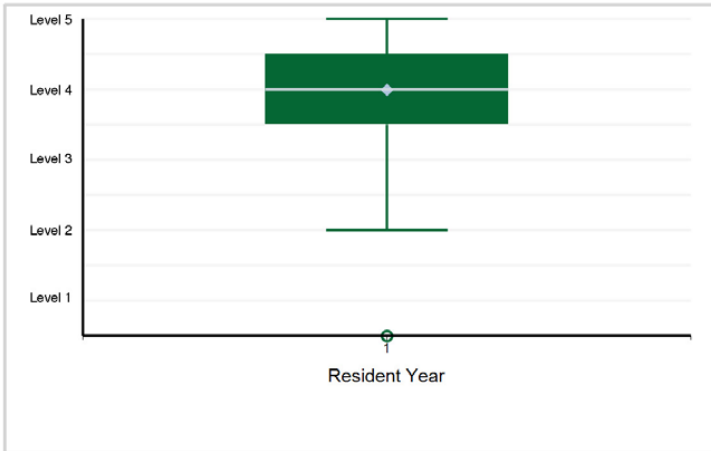

14. Interpersonal and Communication Skills - 1: Patient- and Family-Centered Communication

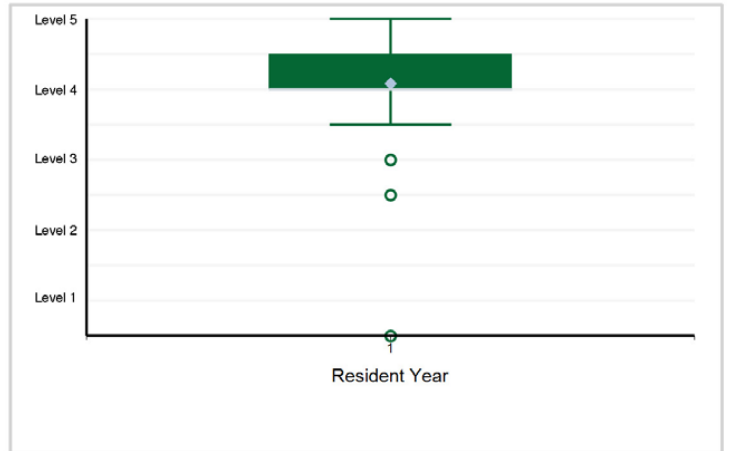

15. Interpersonal and Communication Skills - 2: Interprofessional and Team Communication

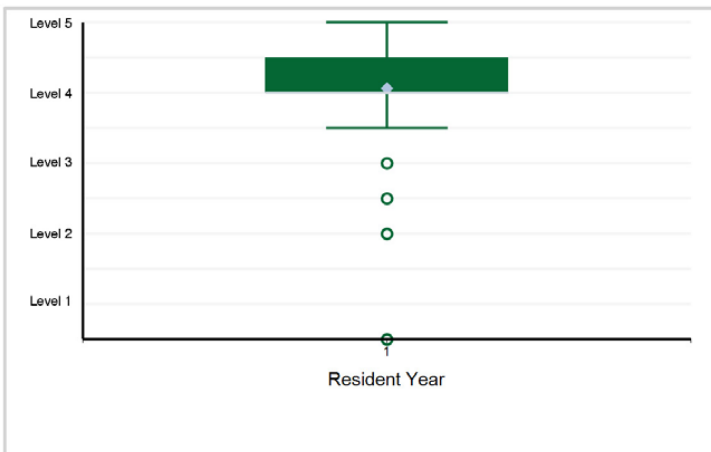

16. Interpersonal and Communication Skills - 3: Communication within Health Care Systems

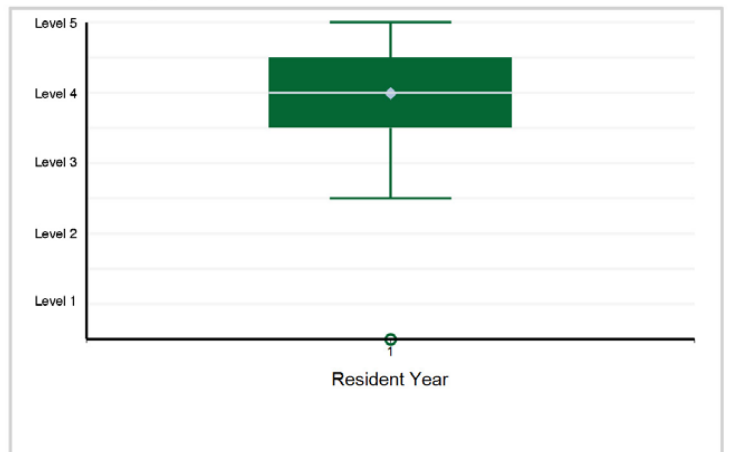

Specialty Box Plot Report - Milestone Evaluation by Resident Year: Year-End 2021-2022

TABLE 125: SUBSPECIALTY: **Addiction Psychiatry**

Resident Year	1	Total Residents
# of Residents	87	87

1. Patient Care - PC1 — Evaluation and diagnosis of the patient A. Thorough evaluation of the patient ...

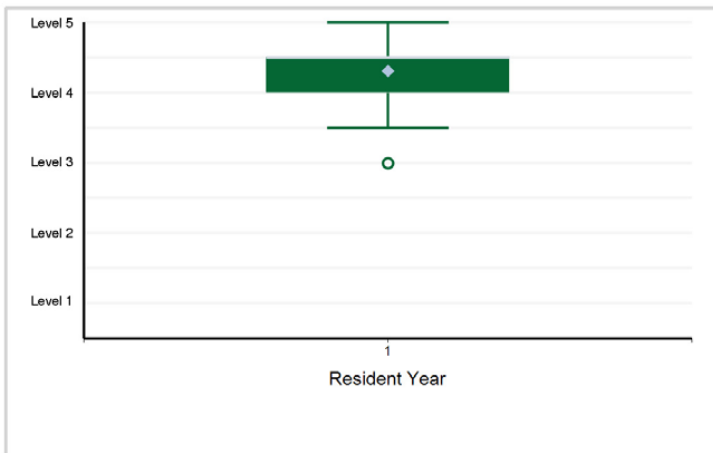

2. Patient Care - PC2 — Psychotherapy, behavioral, and psychosocial interventions in substance and addictive disorders A. ...

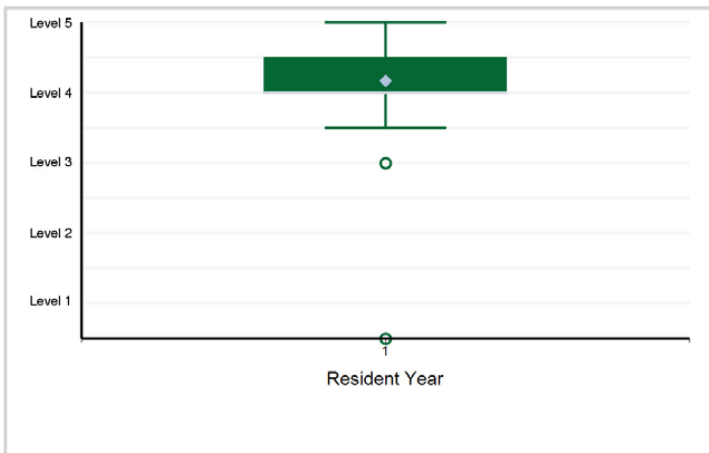

3. Patient Care - PC3 — Pharmacological interventions for substance use and addictive disorders A. Uses ...

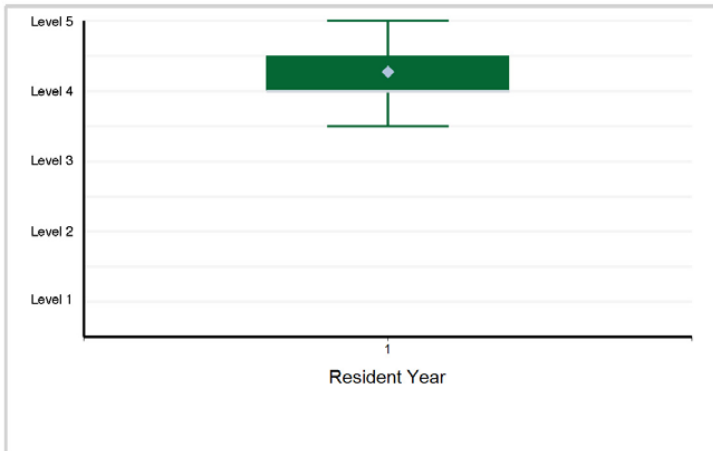

4. Medical Knowledge - MK1 — Clinical neuroscience of substance use and addictive disorders A. Neuroanatomy ...

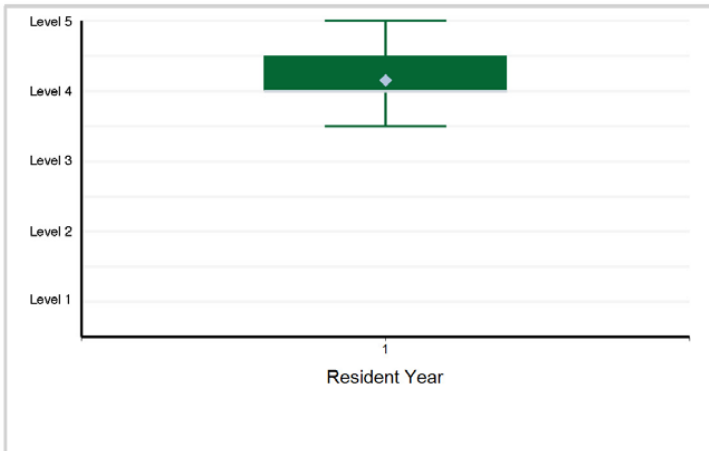

5. Medical Knowledge - MK2 — Psychopathology: including diagnostic criteria, epidemiology, pathophysiology, ...

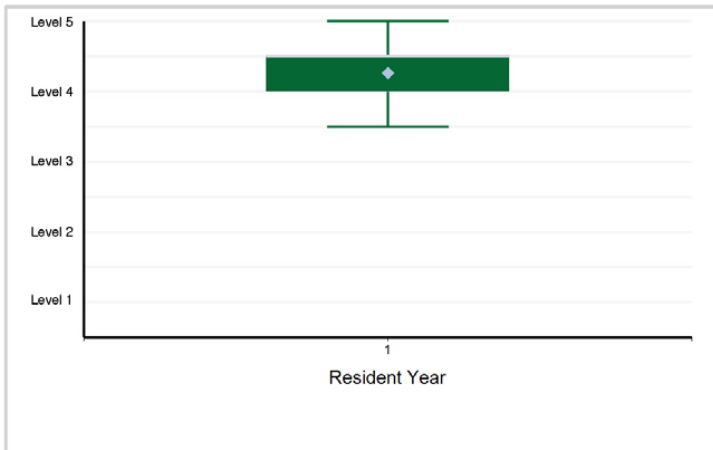

6. Medical Knowledge - MK3 — Psychotherapy, behavioral, and psychosocial treatments: including individual ...

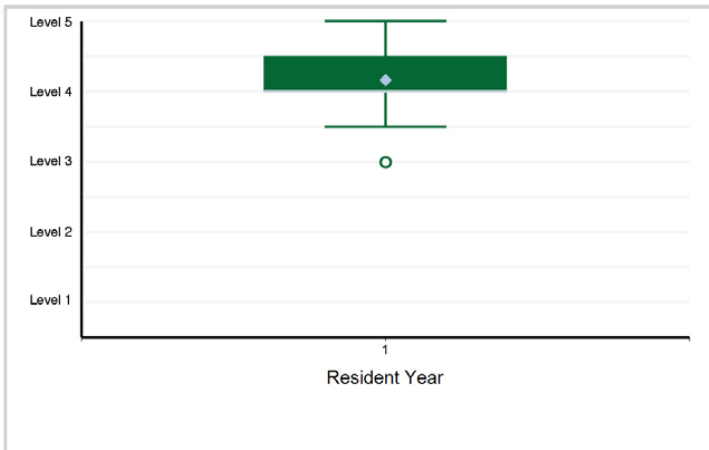

Specialty Box Plot Report - Milestone Evaluation by Resident Year: Year-End 2021-2022

SUBSPECIALTY: Addiction Psychiatry

7. Systems-Based Practice - SBP1 — Patient Safety and the Health Care Team A. Medical errors and improvement ...

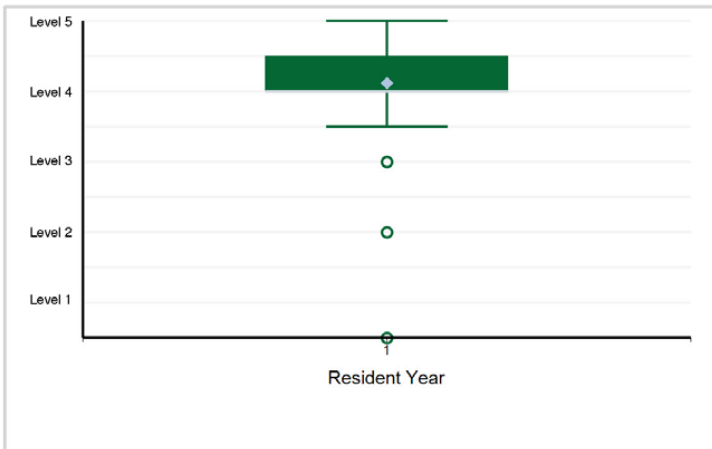

8. Systems-Based Practice - SBP2 — Resource Management: Costs of care and resource management in addiction treatment

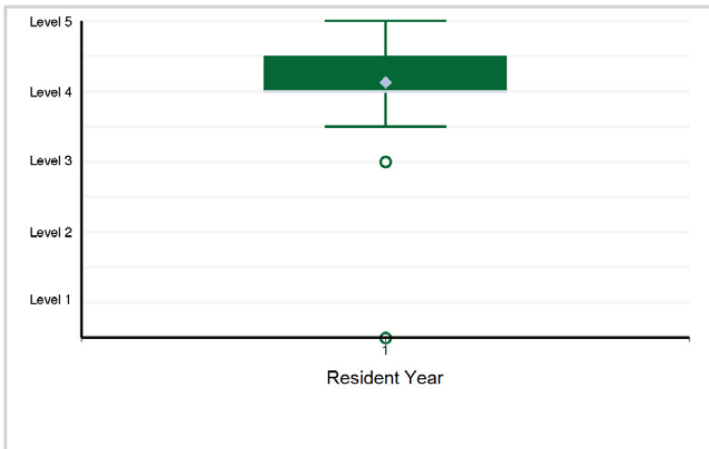

9. Systems-Based Practice - SBP3 — Community-based Care A. Community-based programs B. Self-help groups C. Recovery and ...

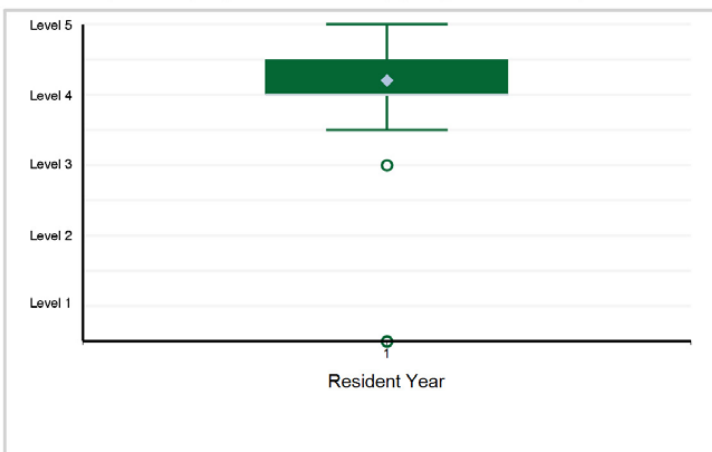

10. Systems-Based Practice - SBP4 — Consultation to general psychiatrists, non-psychiatric medical providers, ...

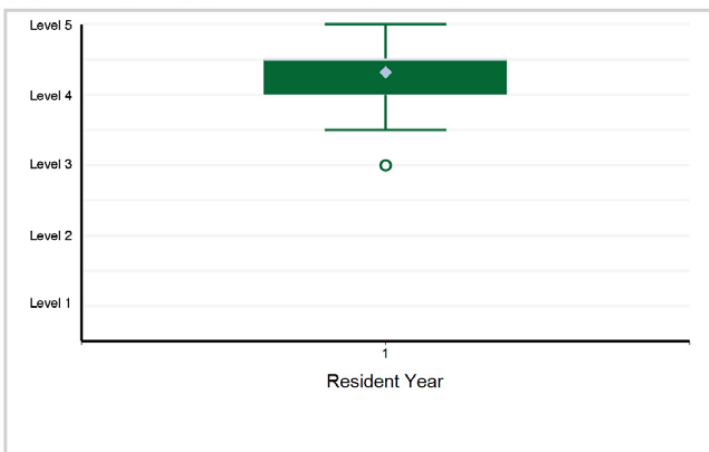

11. Practice-Based Learning and Improvement - PBLI1 — Development and execution of lifelong learning through ...

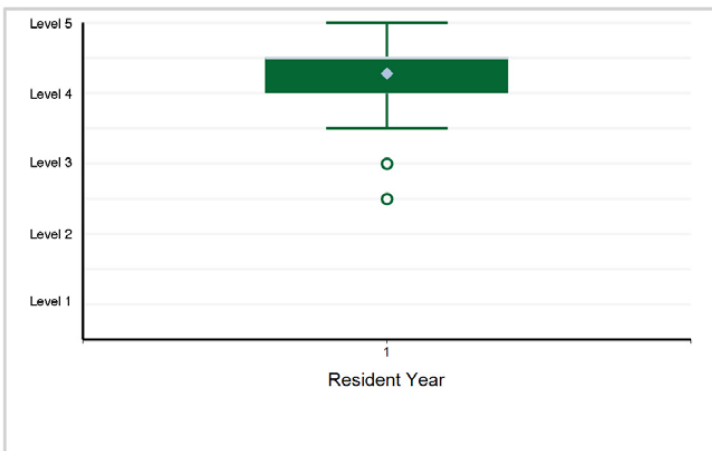

12. Practice-Based Learning and Improvement - PBLI2 — Teaching A. Development as a teacher B. Observable teaching skills

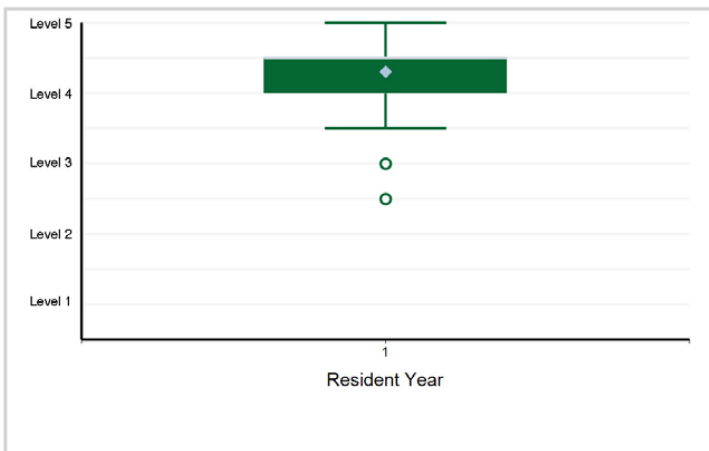

Specialty Box Plot Report - Milestone Evaluation by Resident Year: Year-End 2021-2022

SUBSPECIALTY: **Addiction Psychiatry**

13. Professionalism - PROF1 [see narrative footnote 1] — Compassion, integrity, respect for others, sensitivity ...

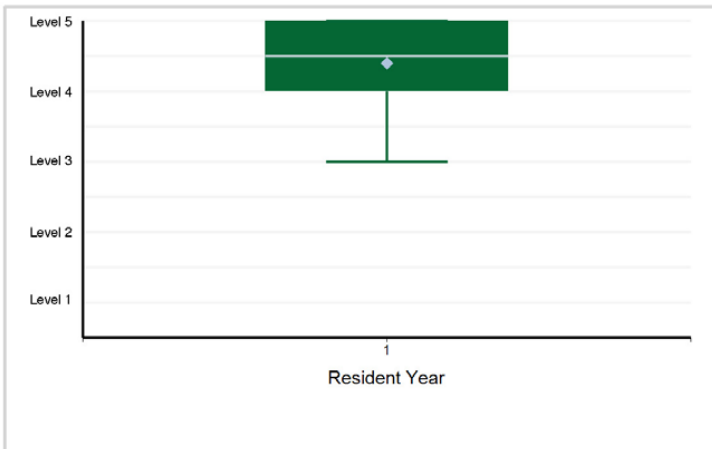

14. Professionalism - PROF2 — Accountability to self, patients, colleagues, and the profession A. Fatigue ...

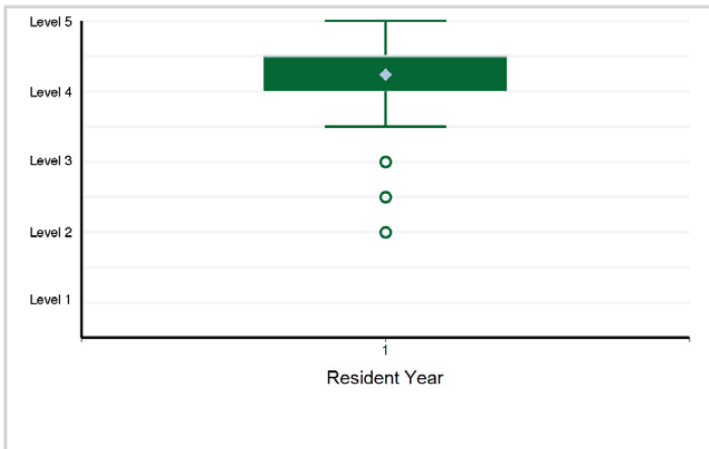

15. Interpersonal and Communication Skills - ICS1 — Relationship development and conflict management with ...

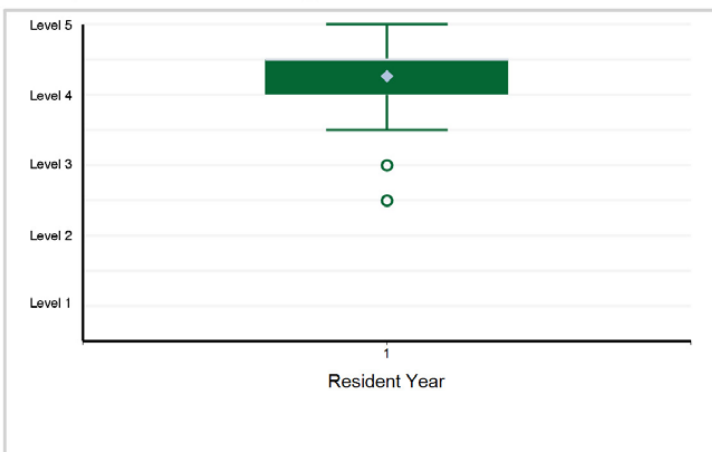

16. Interpersonal and Communication Skills - ICS2 — Information sharing and record keeping A. Accurate ...

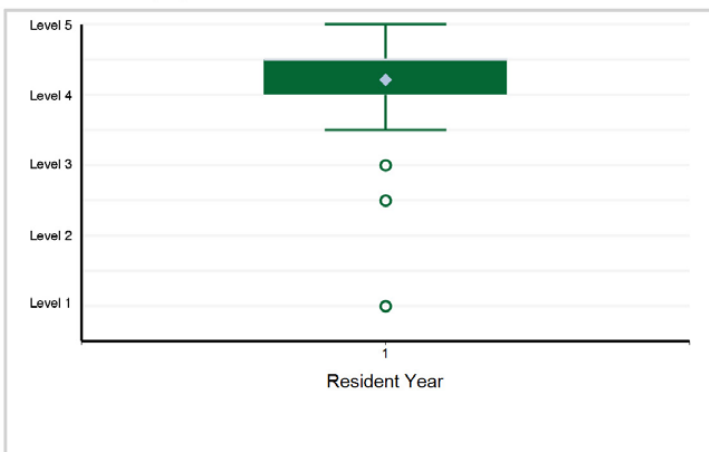

Specialty Box Plot Report - Milestone Evaluation by Resident Year: Year-End 2021-2022

TABLE 126: SUBSPECIALTY: **Child and Adolescent Psychiatry**

Resident Year	1	2	Total Residents*
# of Residents	512	451	963

*Note: There are 2 residents with an incomplete milestone evaluation that are excluded from the box plots below.

1. Patient Care - PC1 — Psychiatric Evaluation

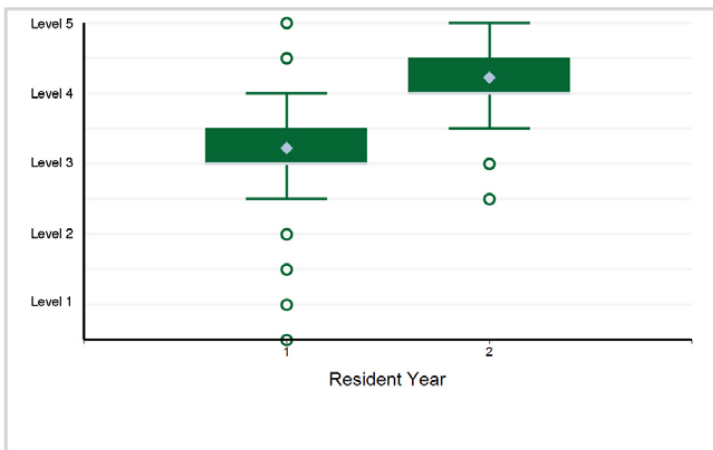

2. Patient Care - PC2 — Psychiatric Formulation and Differential Diagnosis [see narrative footnote 1]

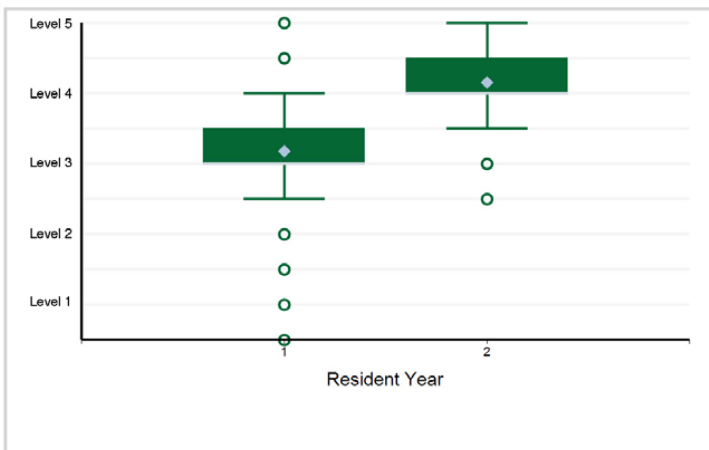

3. Patient Care - PC3 — Treatment Planning and Management

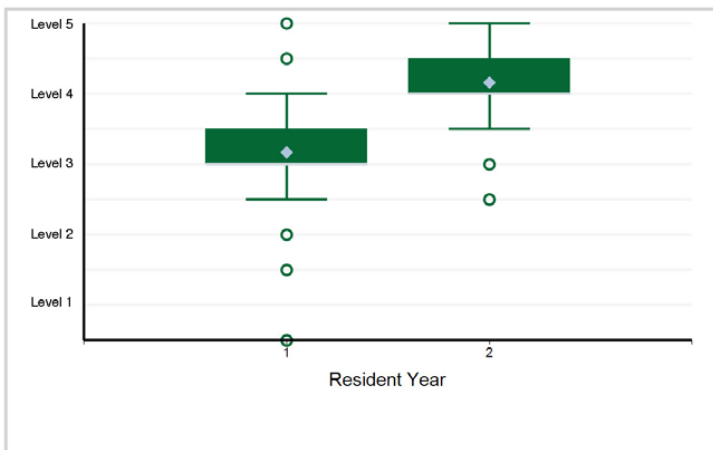

4. Patient Care - PC4 — Psychotherapy

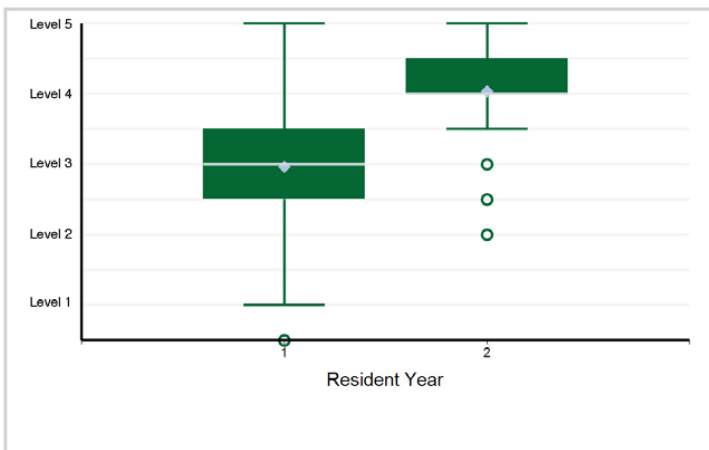

5. Patient Care - PC5 — Somatic Therapies, including Psychopharmacology and Other Somatic Treatments

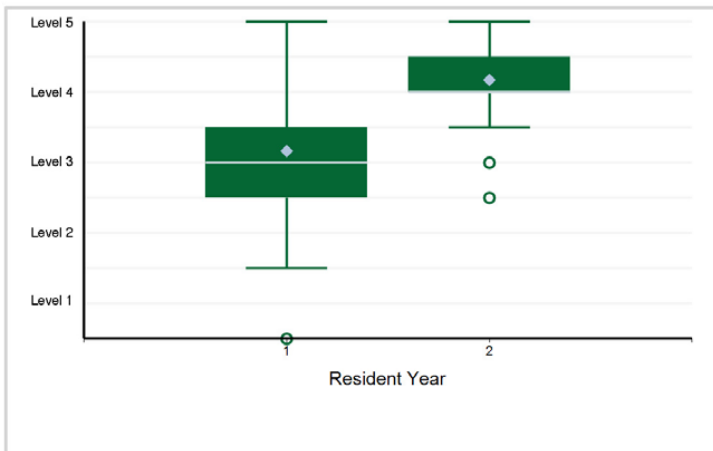

6. Medical Knowledge - MK1 — Development in Infancy, Childhood, and Adolescence, Including the Impact of ...

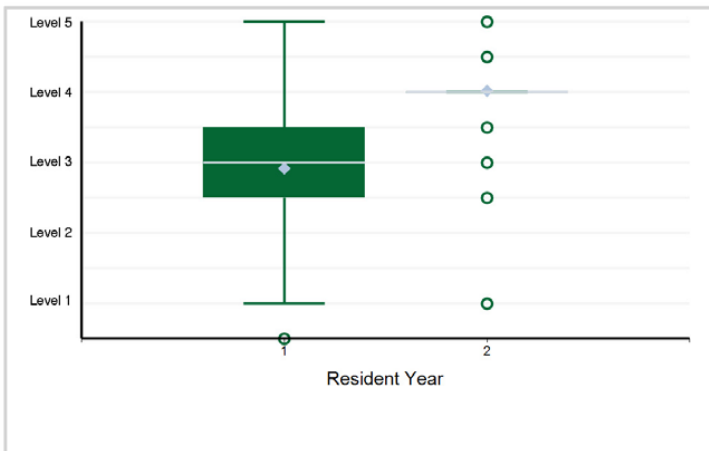

Specialty Box Plot Report - Milestone Evaluation by Resident Year: Year-End 2021-2022

SUBSPECIALTY: Child and Adolescent Psychiatry

7. Medical Knowledge - MK2 — Psychopathology and Wellness, including Knowledge of Diagnostic Criteria, ...

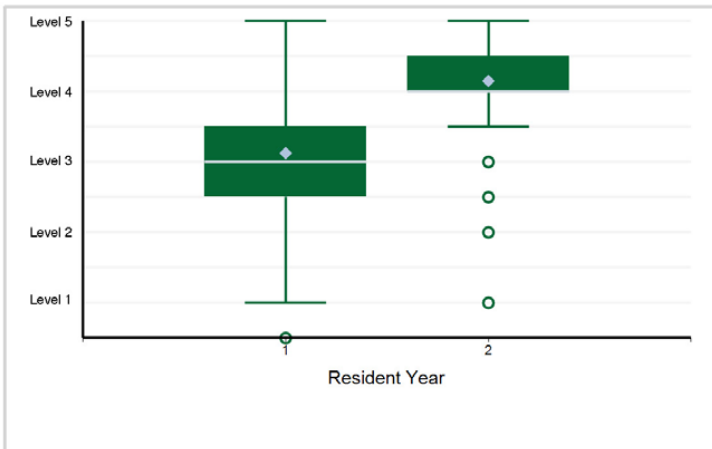

8. Medical Knowledge - MK3 — Clinical Neuroscience and Genetics, including Knowledge of Neurology, Neuropsychiatry, ...

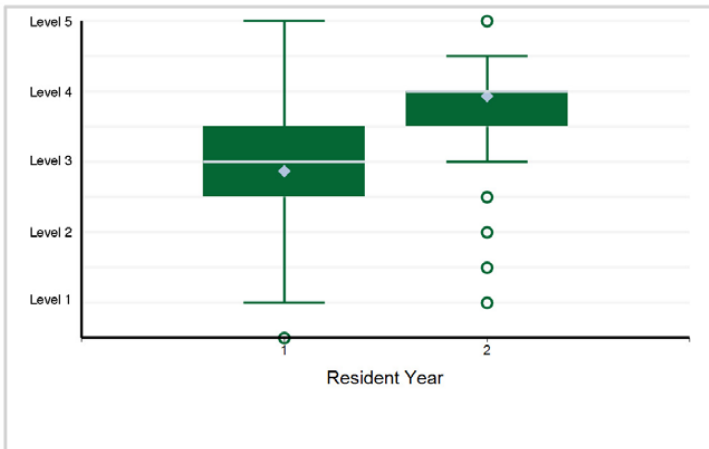

9. Medical Knowledge - MK4 — Psychotherapy: Refers to knowledge regarding: 1) individual psychotherapies, ...

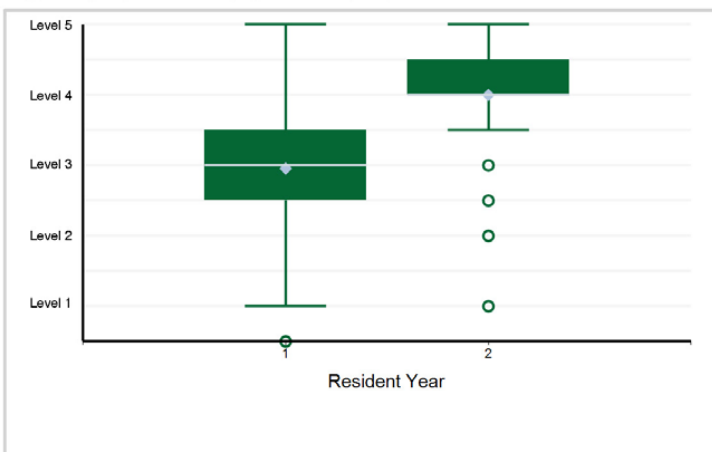

10. Medical Knowledge - MK5 — Somatic Therapies: Medical Knowledge of Somatic Therapies, including Psychopharmacology, ECT, ...

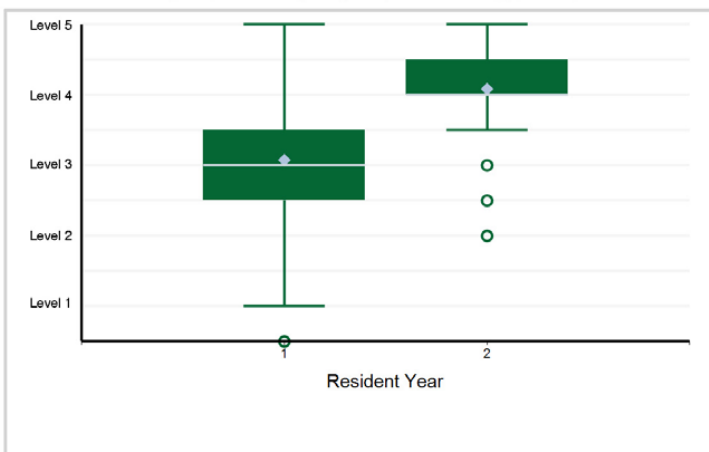

11. Medical Knowledge - MK6 — Practice of Psychiatry

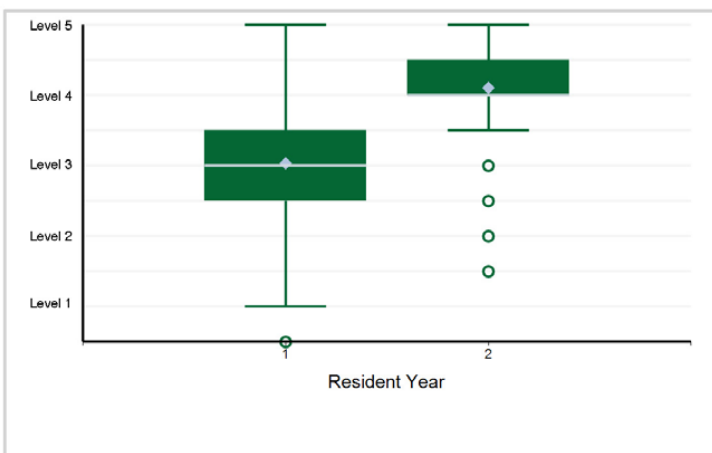

12. Systems-Based Practice - SBP1 — Patient Safety and the Health Care Team

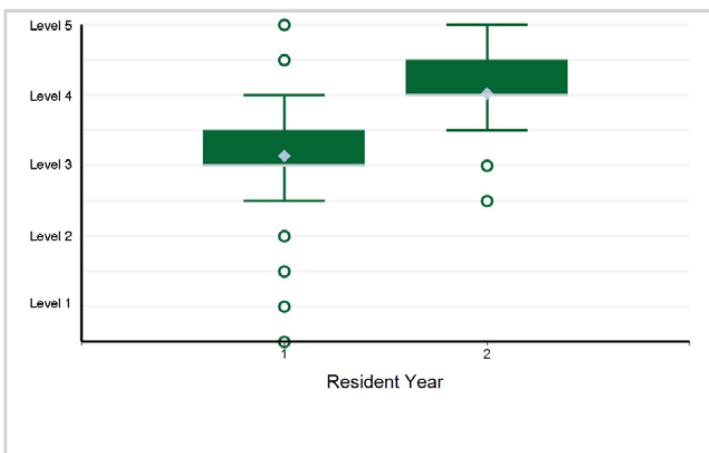

Specialty Box Plot Report - Milestone Evaluation by Resident Year: Year-End 2021-2022

SUBSPECIALTY: Child and Adolescent Psychiatry

13. Systems-Based Practice - SBP2 — Resource Management

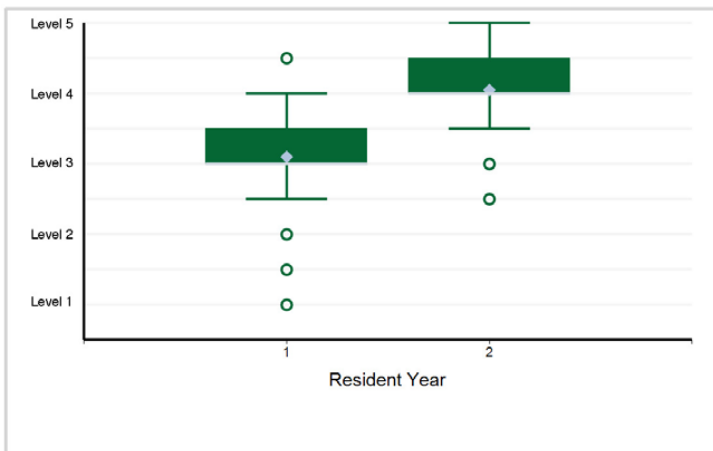

14. Systems-Based Practice - SBP3 — Community-based Care

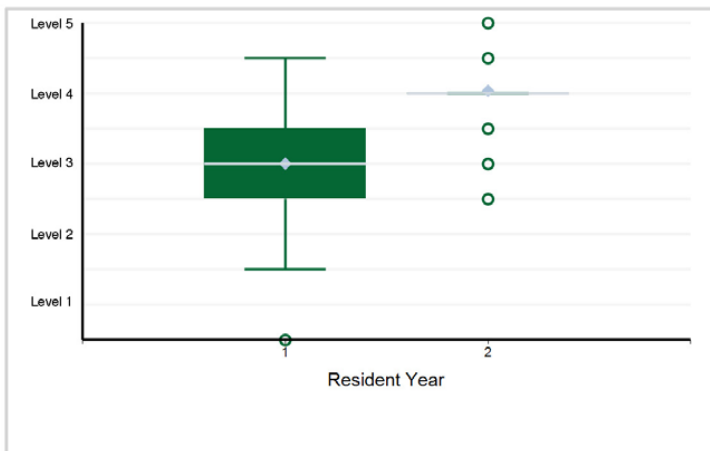

15. Systems-Based Practice - SBP4 — Consultation to and Integration with Non-psychiatric Medical Providers ...

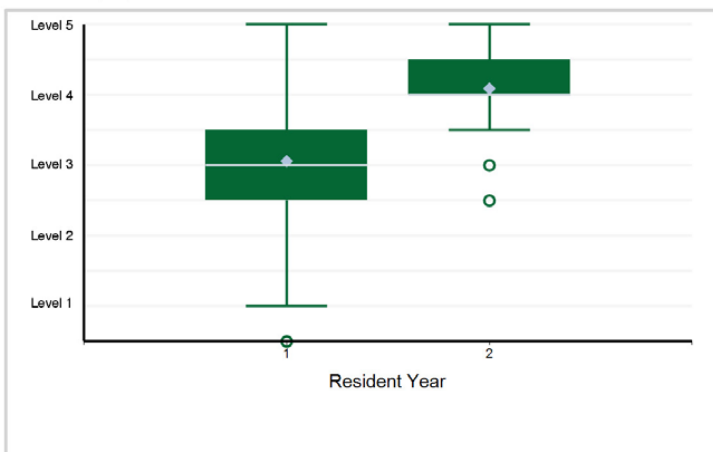

16. Practice-Based Learning and Improvement - PBL1 — Development and Execution of Lifelong Learning through ...

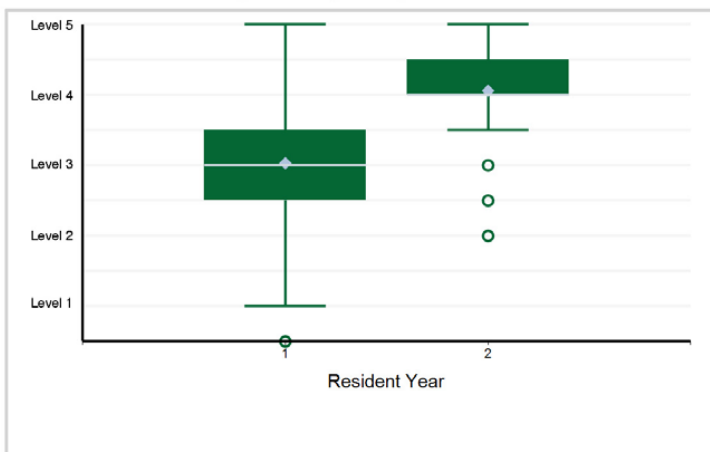

17. Practice-Based Learning and Improvement - PBL2 — Teaching

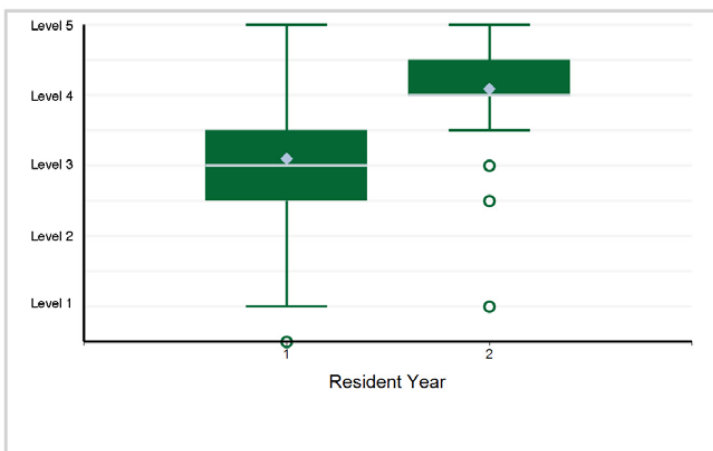

18. Professionalism - PROF1 — Compassion, Integrity, Respect for Others, Sensitivity to Diverse Patient ...

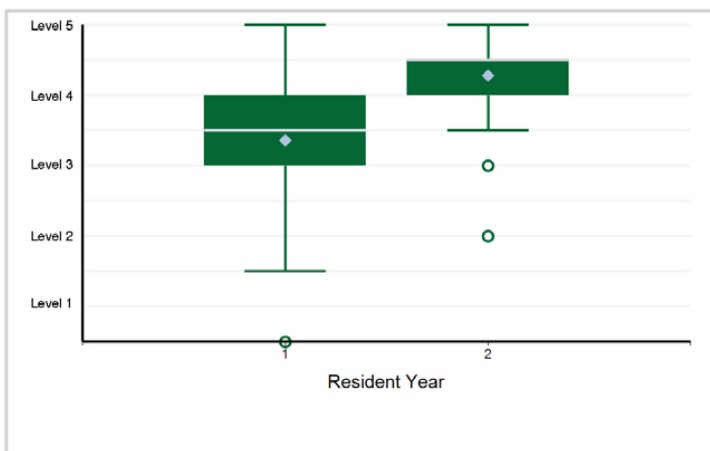

Specialty Box Plot Report - Milestone Evaluation by Resident Year: Year-End 2021-2022

SUBSPECIALTY: Child and Adolescent Psychiatry

19. Professionalism - PROF2 — Accountability to Self, Patients, Colleagues, and the Profession

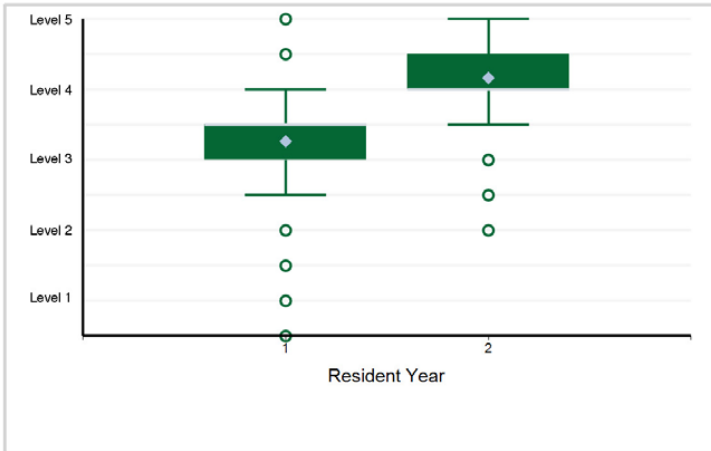

20. Interpersonal and Communication Skills - ICS1 — Relationship Development and Conflict Management with ...

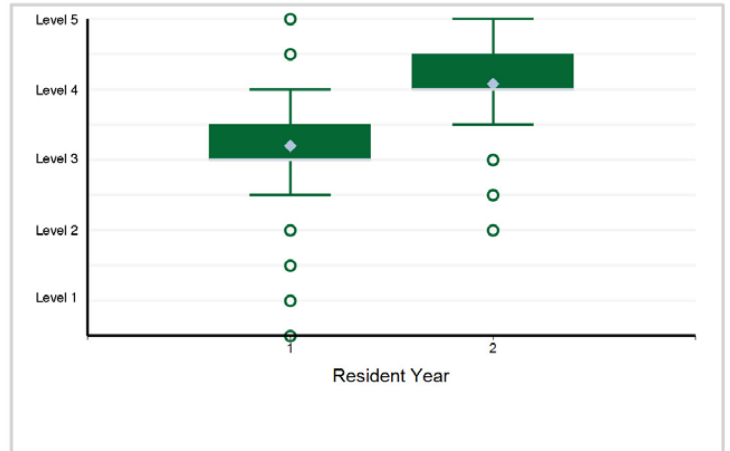

21. Interpersonal and Communication Skills - ICS2 — Information Sharing and Record Keeping

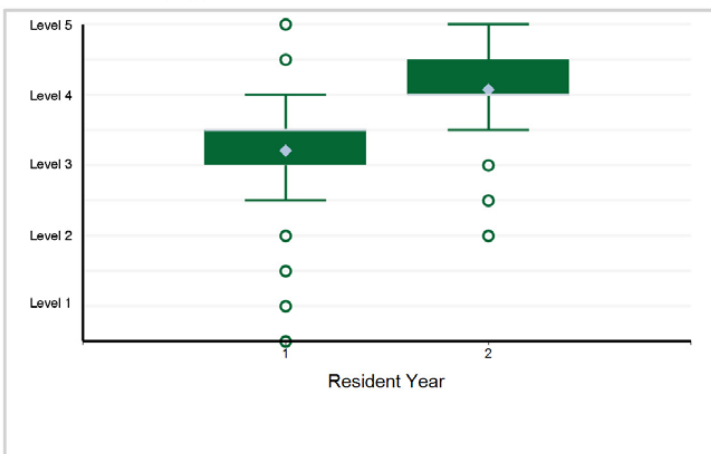

Specialty Box Plot Report - Milestone Evaluation by Resident Year: Year-End 2021-2022

TABLE 127: SUBSPECIALTY: **Consultation-Liaison Psychiatry**

Resident Year	1	Total Residents
# of Residents	93	93

1. Patient Care - PC1 — Consultative Patient Care: clarifying the question, gathering data and collateral ...

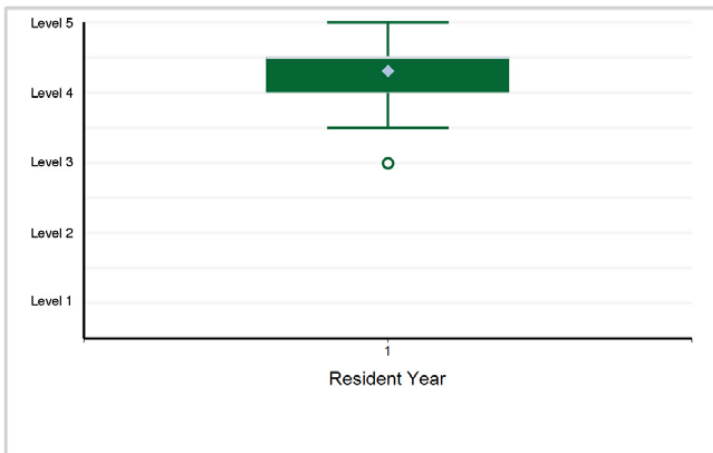

2. Patient Care - PC2 — Integrated Patient Care: performing, coordinating, and supervising care in multidisciplinary ...

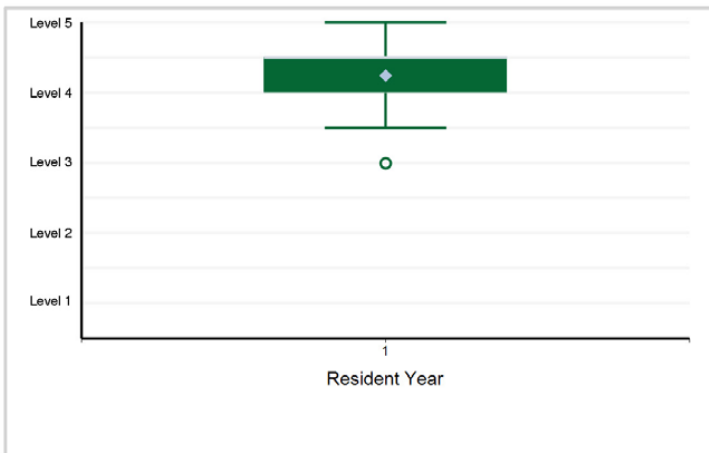

3. Medical Knowledge - MK1 — Knowledge regarding Psychiatric Illnesses in the Medically Ill: assessment ...

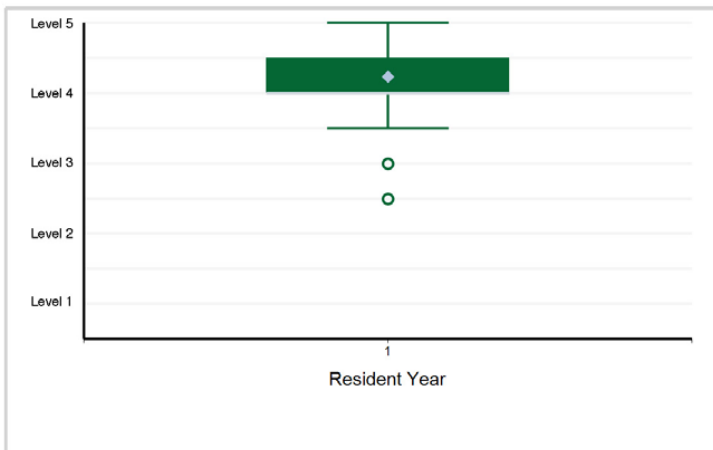

4. Medical Knowledge - MK2 — Knowledge regarding Psychiatric Manifestations of Medical Illnesses: assessment ...

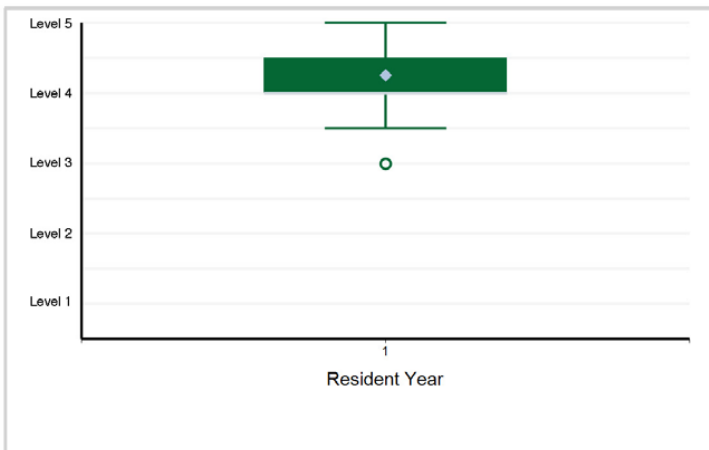

5. Medical Knowledge - MK3 — Practice of Psychosomatic Medicine A. Ethics and legal issues B. Models of consultation and ...

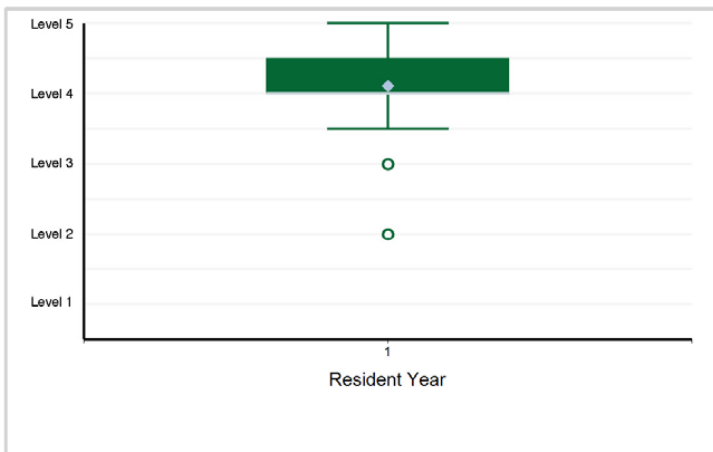

6. Systems-Based Practice - SBP1 — Patient Safety and the Health Care Team A. Medical errors and quality ...

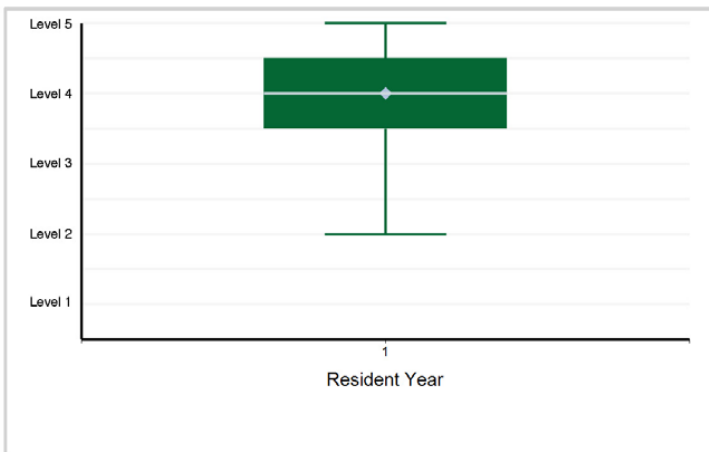

Specialty Box Plot Report - Milestone Evaluation by Resident Year: Year-End 2021-2022

SUBSPECIALTY: Consultation-Liaison Psychiatry

7. Systems-Based Practice - SBP2 — Resource Management: costs of care and resource selection

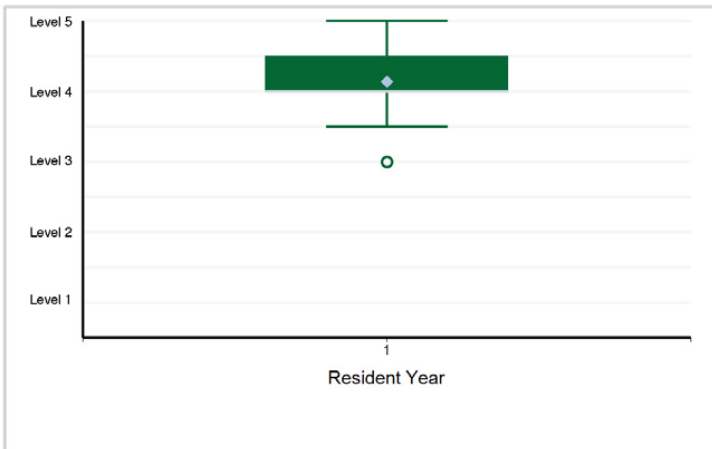

8. Systems-Based Practice - SBP3 — Community-based Care: community-based programs; self-help groups, including ...

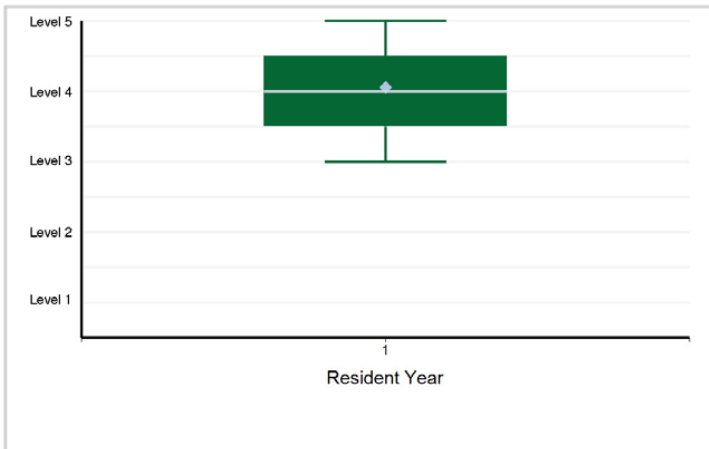

9. Systems-Based Practice - SBP4 — Consultation to Health Care Systems

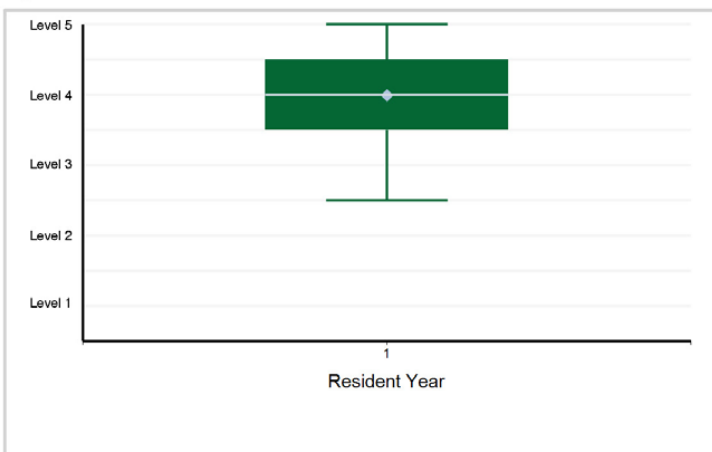

10. Practice-Based Learning and Improvement - PBL1 — Lifelong Learning A. Self-assessment and self-improvement B. Use of ...

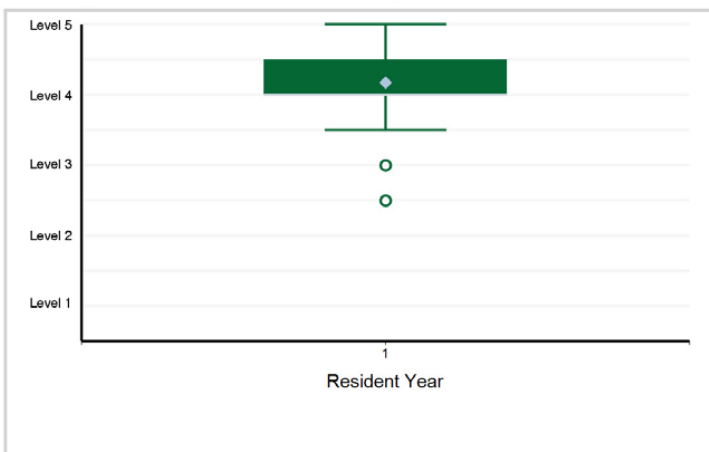

11. Practice-Based Learning and Improvement - PBL2 — Teaching A. Development as a teacher B. Observable teaching skills

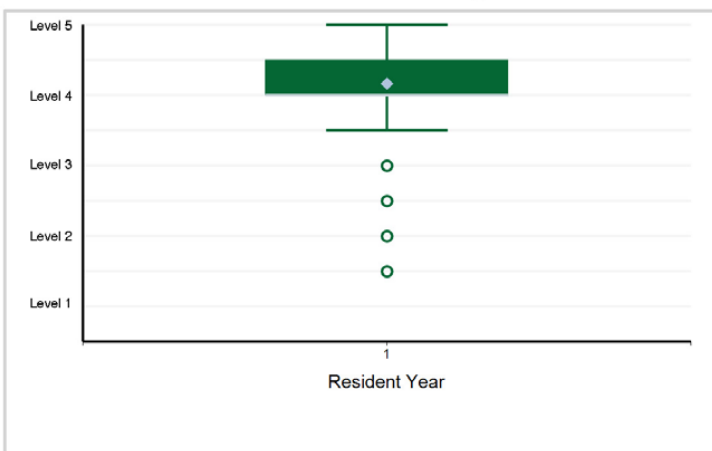

12. Professionalism - PROF1 — Compassion, Integrity, and Respect A. Compassion for others, self-reflection, sensitivity to ...

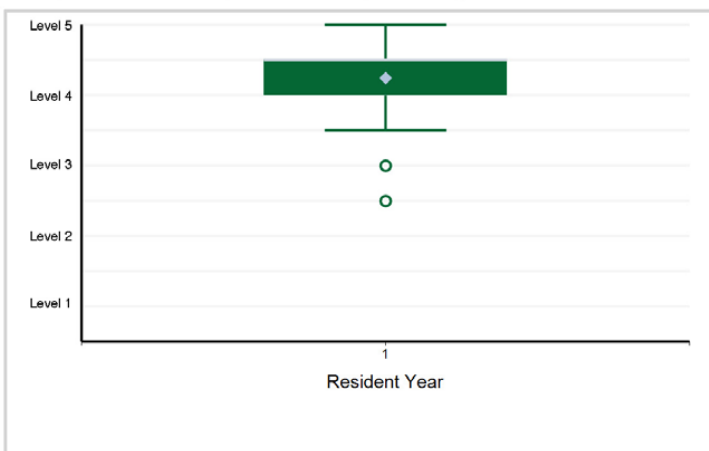

Specialty Box Plot Report - Milestone Evaluation by Resident Year: Year-End 2021-2022

SUBSPECIALTY: Consultation-Liaison Psychiatry

13. Professionalism - PROF2 — Accountability to Self, Patients, Colleagues, and Profession A. Work balance ...

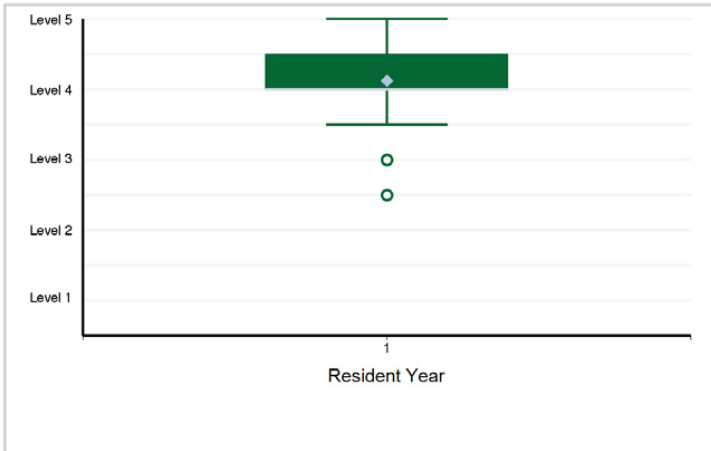

14. Interpersonal and Communication Skills - ICS1 — Relationship Development and Conflict Management A. ...

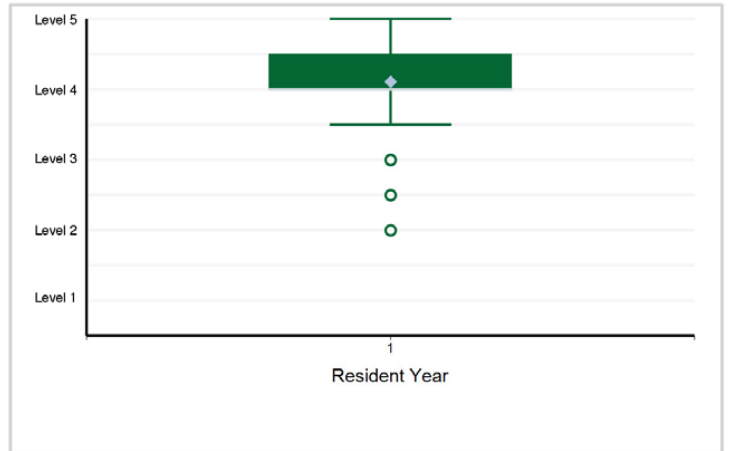

15. Interpersonal and Communication Skills - ICS2 — Information Sharing and Record Keeping A. Accurate ...

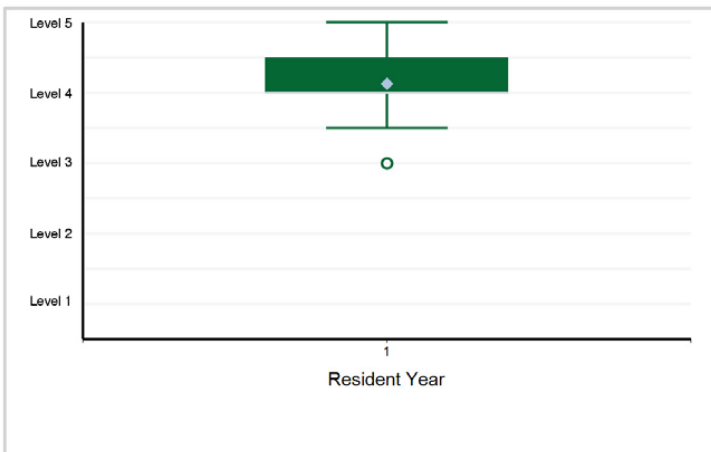

Specialty Box Plot Report - Milestone Evaluation by Resident Year: Year-End 2021-2022

TABLE 128: SUBSPECIALTY: **Forensic Psychiatry**

Resident Year	1	Total Residents
# of Residents	91	91

1. Patient Care - PC1 — Patient Care A. Provides psychiatric care in a forensic setting

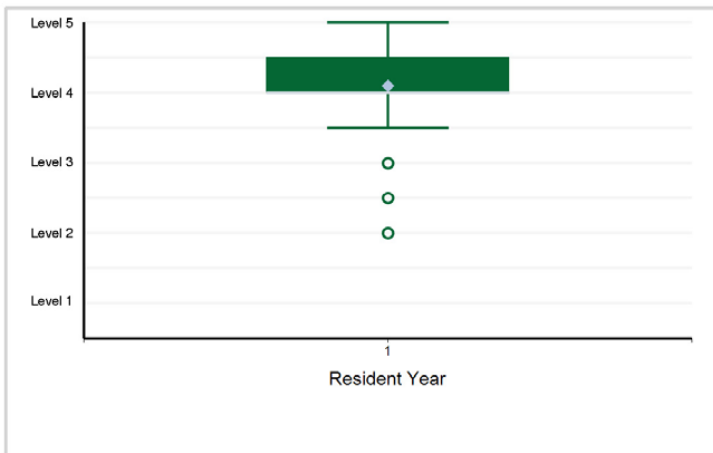

2. Patient Care - PC2 — Procedural Skills A. Conducts a forensic psychiatric evaluation in criminal and ...

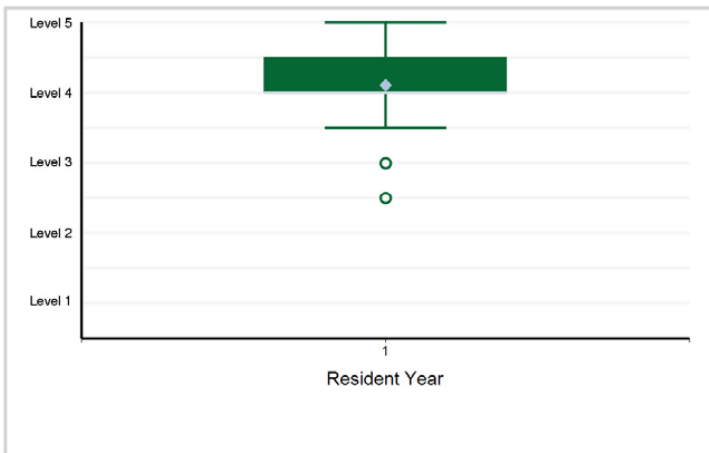

3. Medical Knowledge - MK1 — Knowledge of the Law and Ethical Principles as they relate to the Practice ...

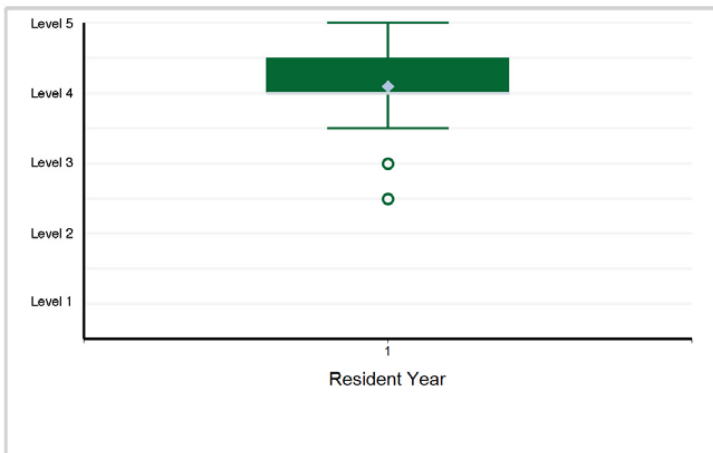

4. Medical Knowledge - MK2 — Knowledge of Clinical Psychiatry Especially Relevant to Forensic Psychiatry ...

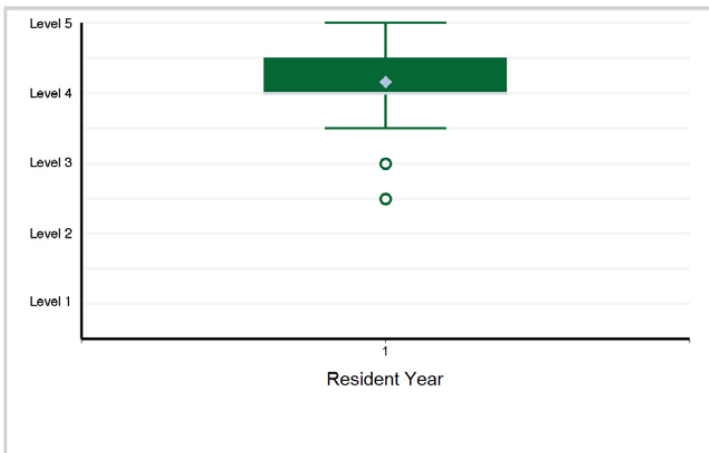

5. Systems-Based Practice - SBP1 — Patient/Evalinee Safety and the Health Care Team A. Medical errors and ...

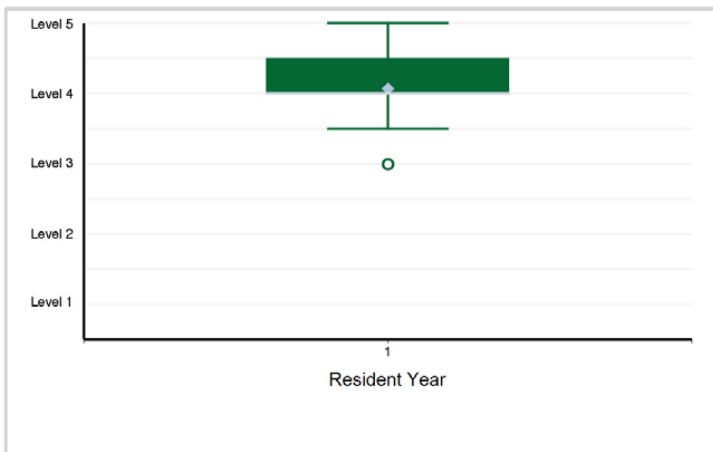

6. Systems-Based Practice - SBP2 — Resource Management Costs of care and resource management

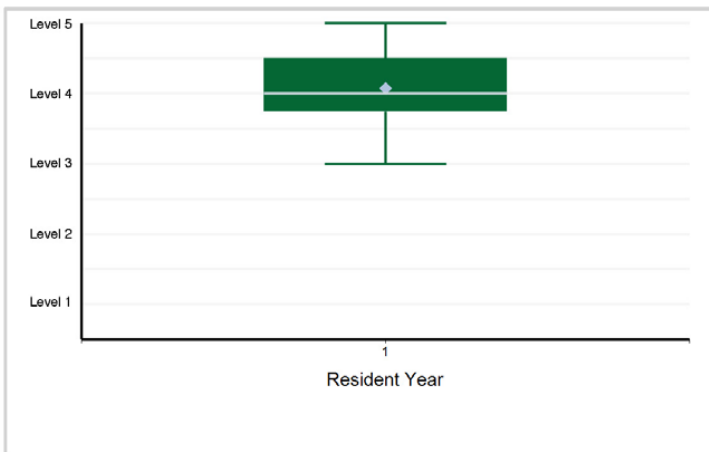

Specialty Box Plot Report - Milestone Evaluation by Resident Year: Year-End 2021-2022

SUBSPECIALTY: Forensic Psychiatry

7. Systems-Based Practice - SBP3 — Consultation to Medical Providers and Non-medical systems (e.g., military, ...

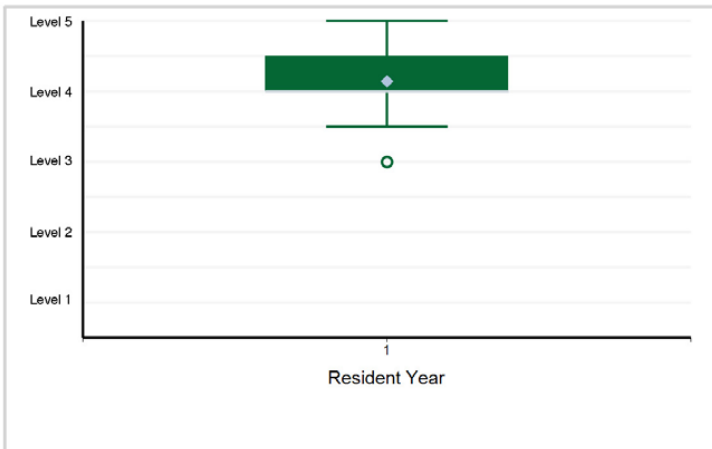

8. Practice-Based Learning and Improvement - PBL11 — Development and Execution of Lifelong Learning through ...

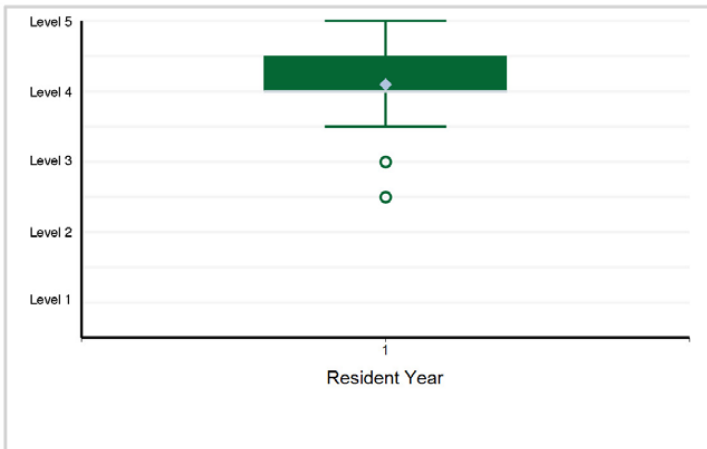

9. Practice-Based Learning and Improvement - PBL12 — Teaching A. Development as a teacher B. Observable teaching skills

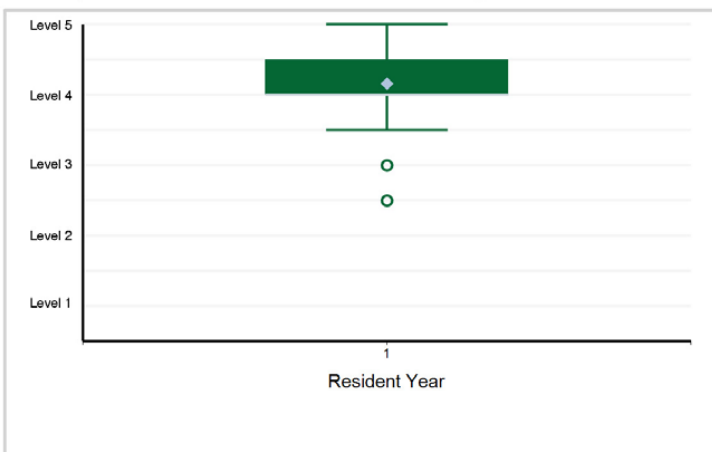

10. Professionalism - PROF1 — Compassion, Integrity, Respect for Others, Sensitivity to Diverse Patient ...

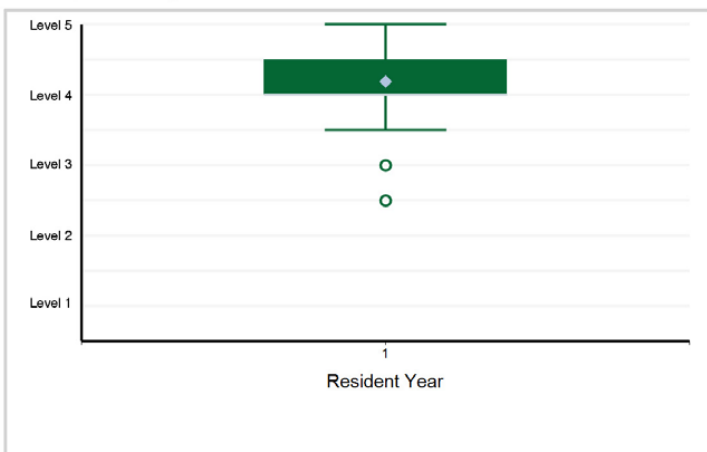

11. Professionalism - PROF2 — Accountability to Self, Patients, Colleagues, Legal Systems, Professionals, ...

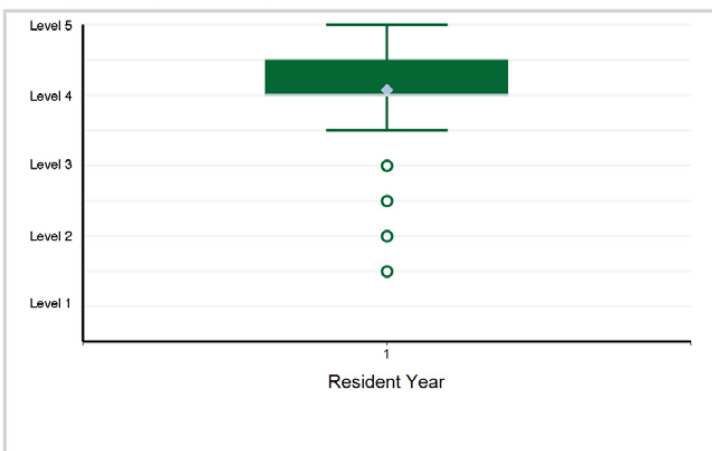

12. Interpersonal and Communication Skills - ICS1 — Relationship Development and Conflict Management with ...



Specialty Box Plot Report - Milestone Evaluation by Resident Year: Year-End 2021-2022

SUBSPECIALTY: **Forensic Psychiatry**

13. Interpersonal and Communication Skills - ICS2 — Information Sharing and Record Keeping A. Accurate and ...



Specialty Box Plot Report - Milestone Evaluation by Resident Year: Year-End 2021-2022

TABLE 128: SUBSPECIALTY: **Geriatric Psychiatry**

Resident Year	1	Total Residents
# of Residents	59	59

1. Patient Care - PC1 - Geriatric Psychiatric Evaluation and Differential Diagnosis A. Geriatric-specific ...

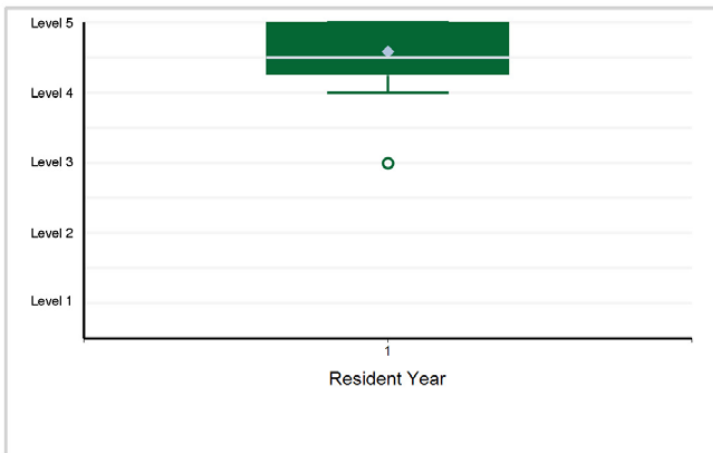

2. Patient Care - PC2 - Geriatric Therapeutic Modalities A. Somatic Therapies [see narrative footnote 2] ...

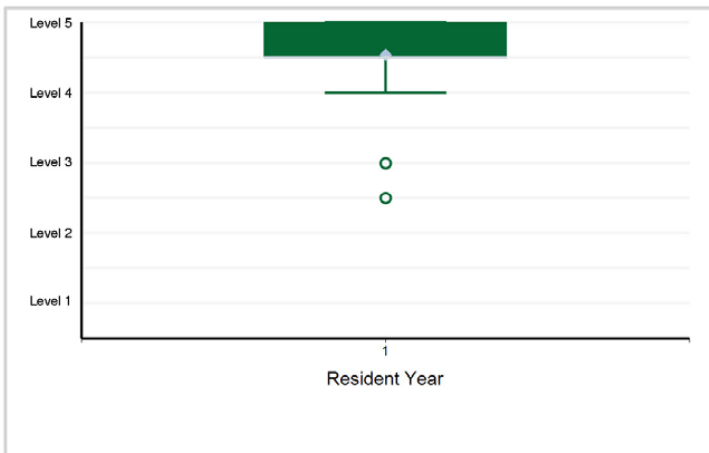

3. Patient Care - PC3 - Treatment Planning and Management A. Participates in the development, management, ...

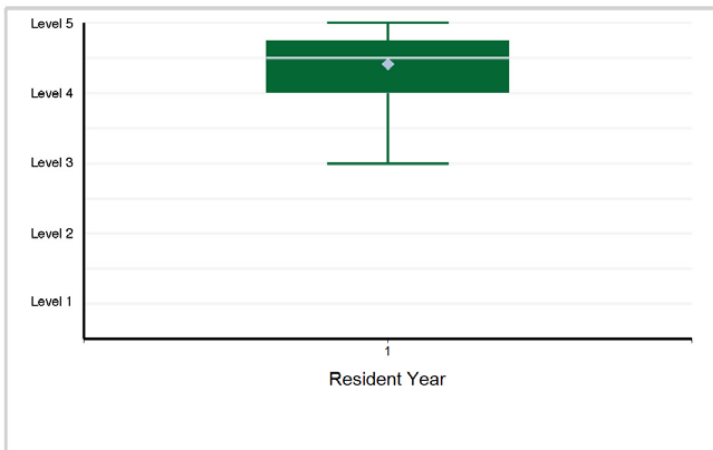

4. Medical Knowledge - MK1 - Development through Later-life A. Knowledge of developmental theories across ...

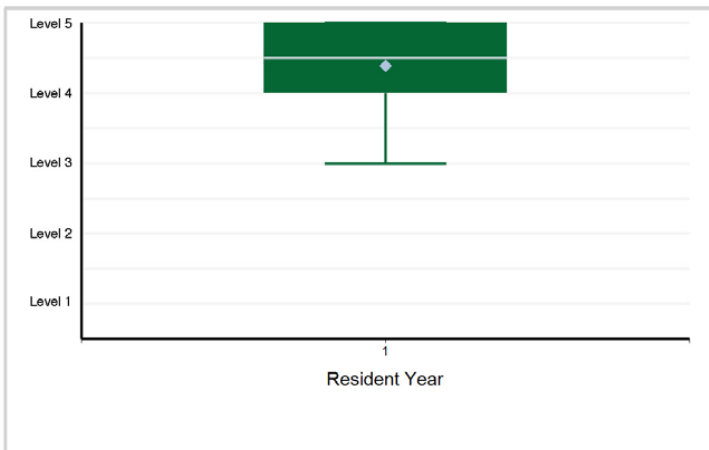

5. Medical Knowledge - MK2 - Psychopathology: Includes Presentation of Psychiatric Disorders in Diverse ...

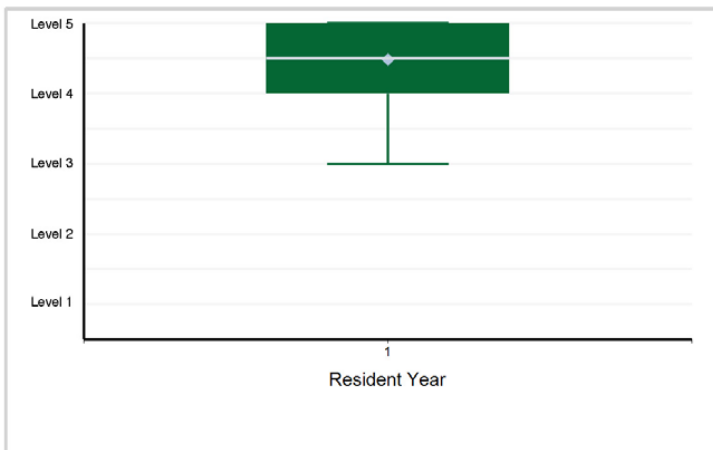

6. Medical Knowledge - MK3 - Treatment and Management A. Somatic therapy B. Non-pharmacological therapies ...

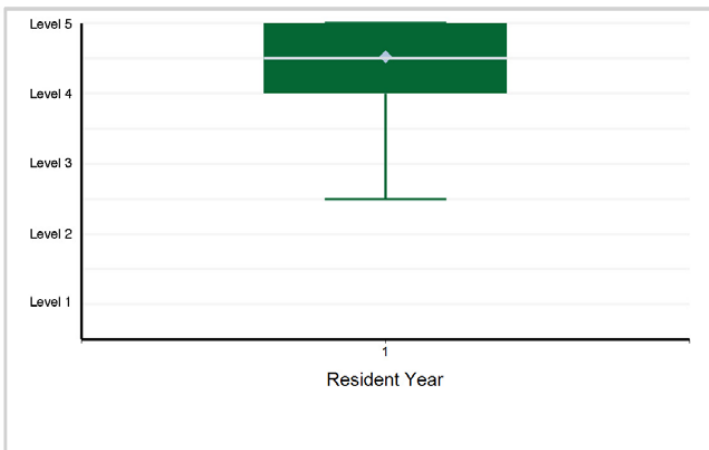

Specialty Box Plot Report - Milestone Evaluation by Resident Year: Year-End 2021-2022

SUBSPECIALTY: Geriatric Psychiatry

7. Systems-Based Practice - SBP1 - Patient Safety and the Health Care Team A. Medical errors and improvement ...

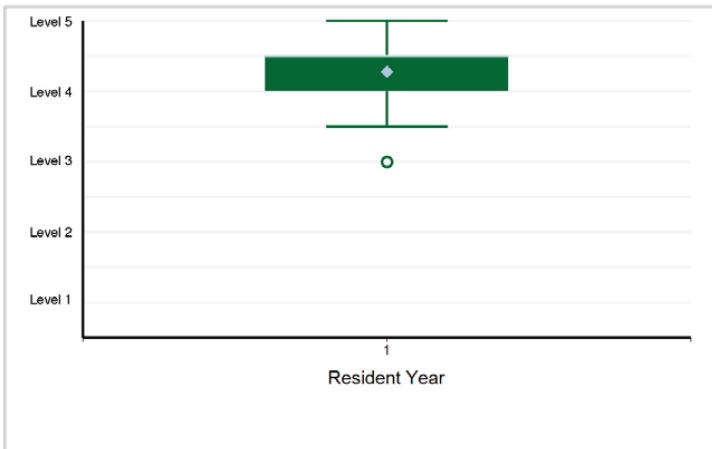

8. Systems-Based Practice - SBP2 - Resource Management: Costs of care and resource management

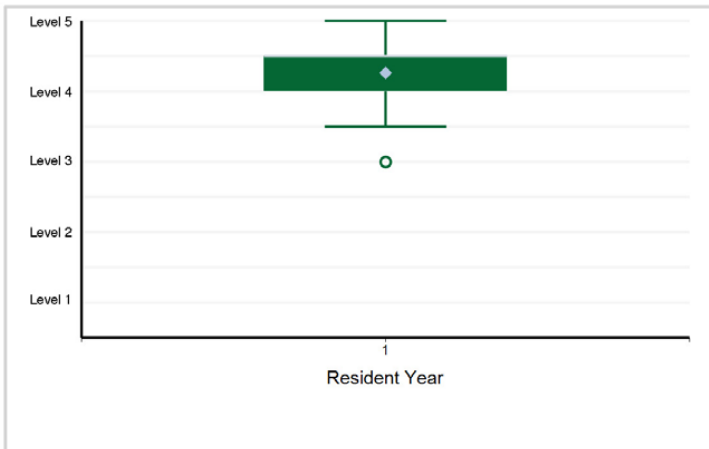

9. Systems-Based Practice - SBP3 - Community-based Care A. Community-based programs B. Self-help groups C. Recovery and rehabilitation

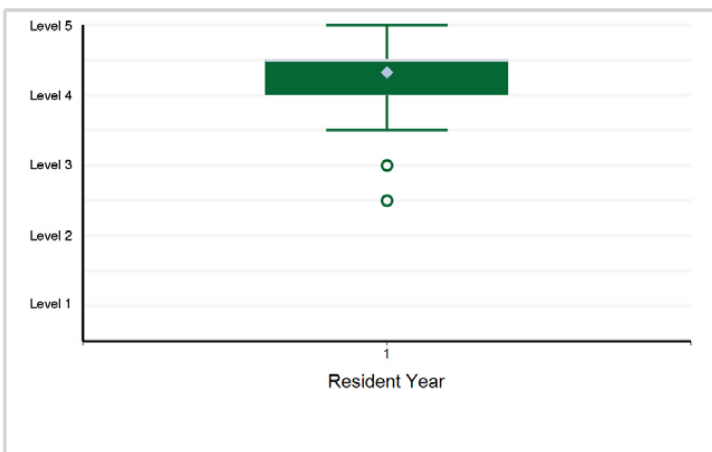

10. Systems-Based Practice - SBP4 - Consultation to non-psychiatric medical providers and non-medical systems ...

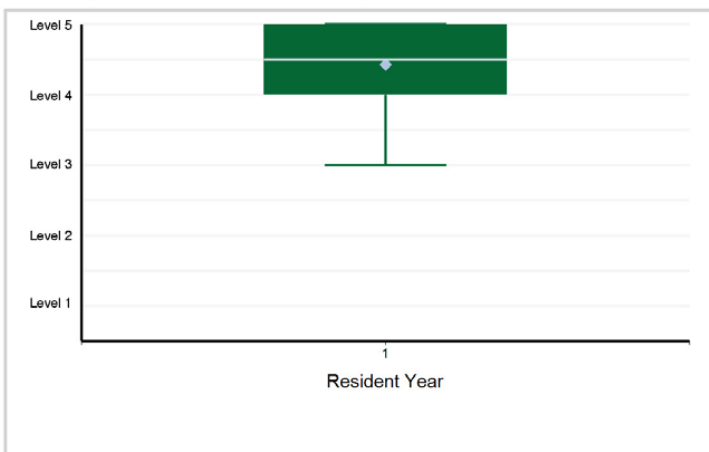

11. Practice-Based Learning and Improvement - PBLI1 - Development and Execution of Lifelong Learning through ...

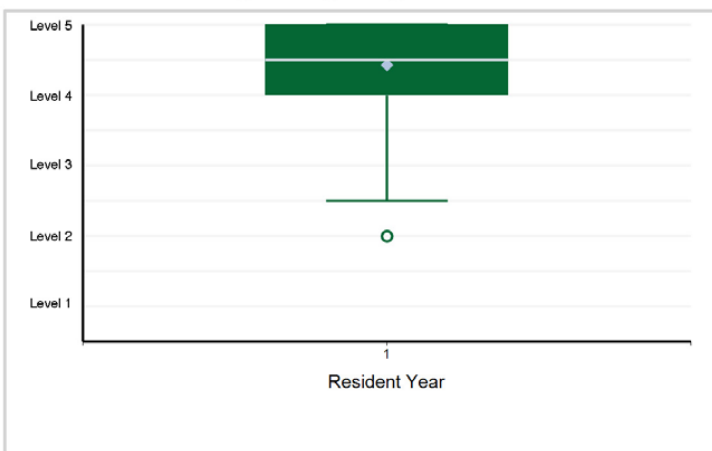

12. Practice-Based Learning and Improvement - PBLI2 - Teaching A. Development as a teacher B. Observable teaching skills

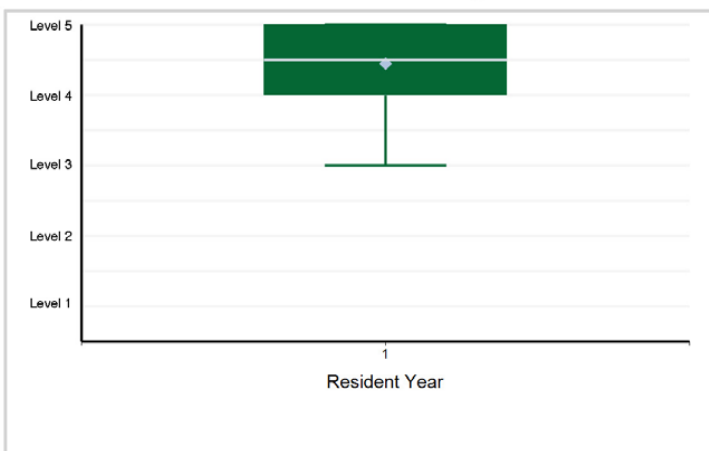

Specialty Box Plot Report - Milestone Evaluation by Resident Year: Year-End 2021-2022

SUBSPECIALTY: Geriatric Psychiatry

13. Professionalism - PROF1 - Compassion, Integrity, Respect for Others, Sensitivity to Diverse Patient ...

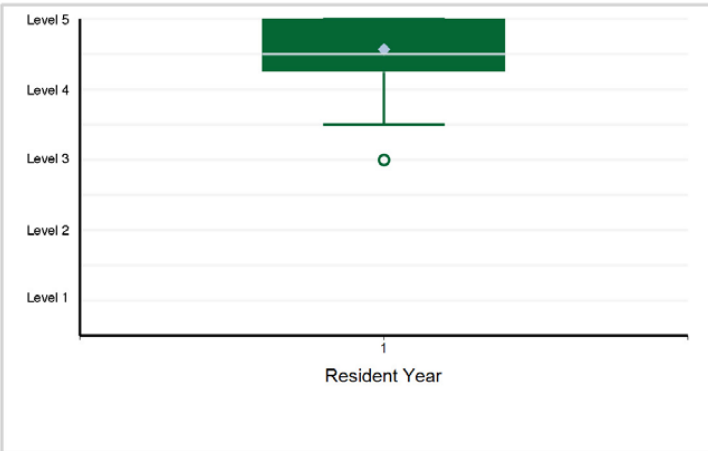

14. Professionalism - PROF2 - Accountability to Self, Patients, Colleagues, and the Profession A. Fatigue ...

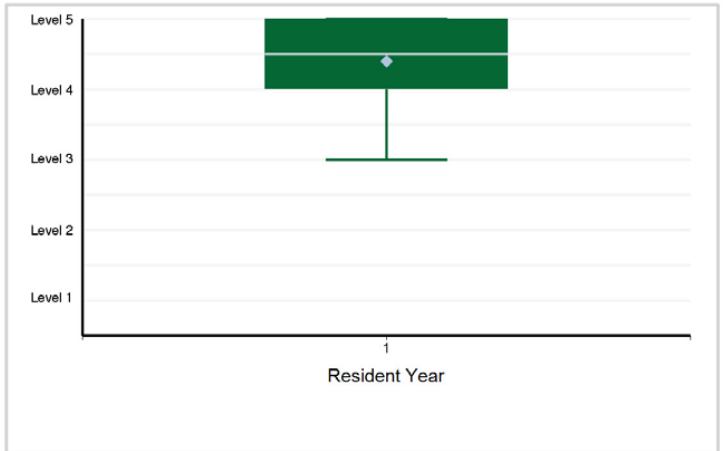

15. Interpersonal and Communication Skills - ICS1 - Relationship Development and Conflict Management with ...

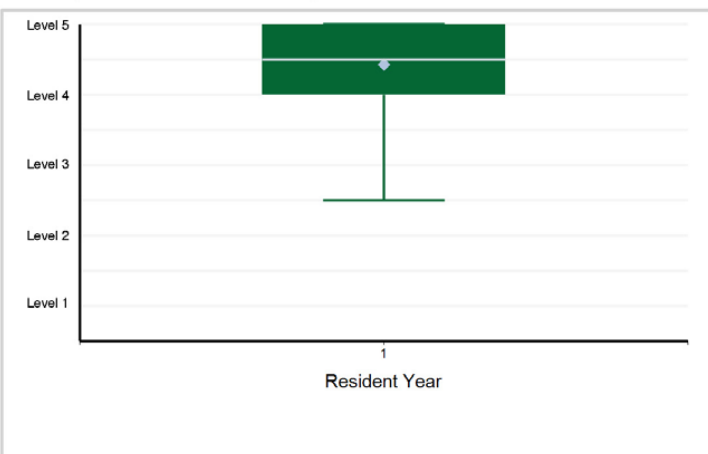

16. Interpersonal and Communication Skills - ICS2 - Information Sharing and Record Keeping A. Accurate and ...

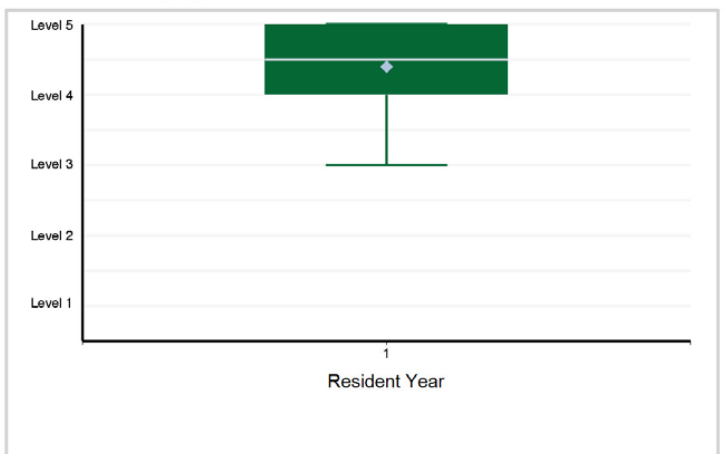

Specialty Box Plot Report - Milestone Evaluation by Resident Year: Year-End 2021-2022

TABLE 130: SPECIALTY: **Radiation Oncology**

Resident Year	1	2	3	4	Total Residents
# of Residents	186	197	186	194	763

1. Patient Care - Lymphoma — Patient Care

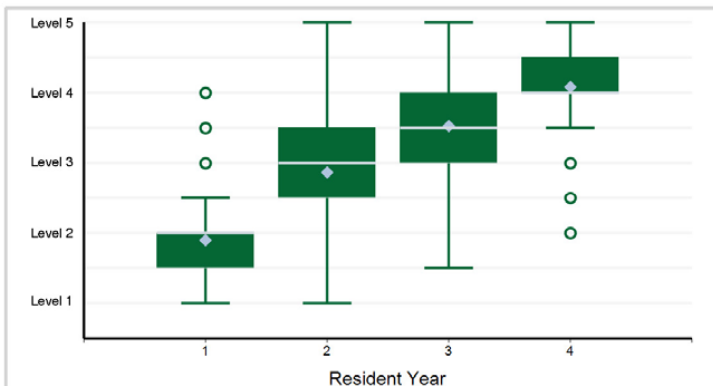

Note: 105 of 763 residents have a status of "Not Yet Rotated" and are not included in the analysis.

2. Patient Care - Head and Neck — Patient Care

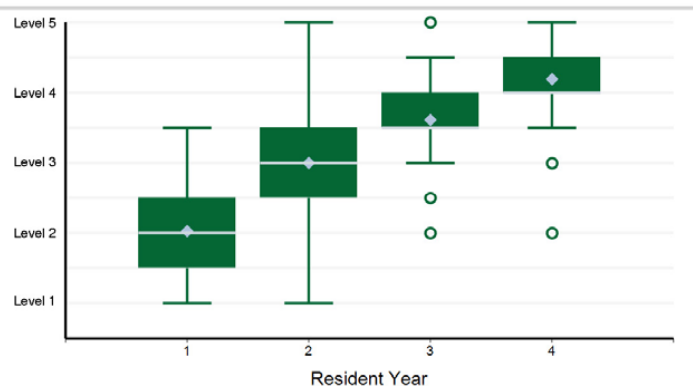

Note: 67 of 763 residents have a status of "Not Yet Rotated" and are not included in the analysis.

3. Patient Care - Genitourinary (GU) — Patient Care

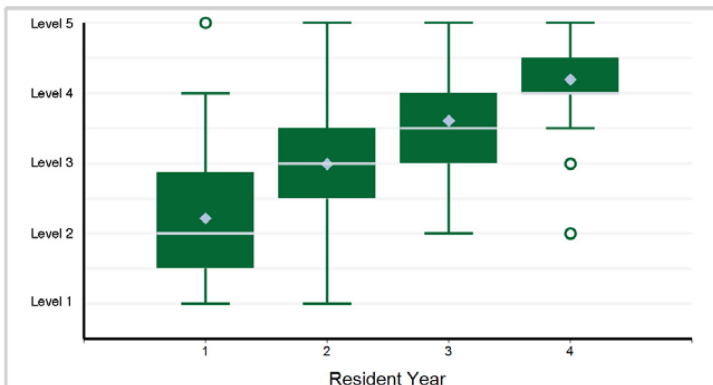

Note: 21 of 763 residents have a status of "Not Yet Rotated" and are not included in the analysis.

4. Patient Care - Palliation — Patient Care

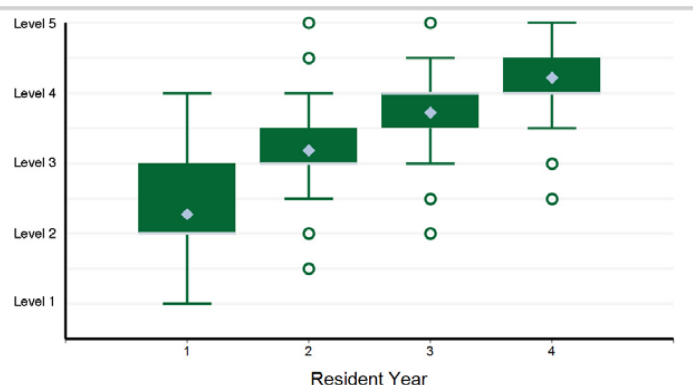

Note: 7 of 763 residents have a status of "Not Yet Rotated" and are not included in the analysis.

5. Patient Care - Breast — Patient Care

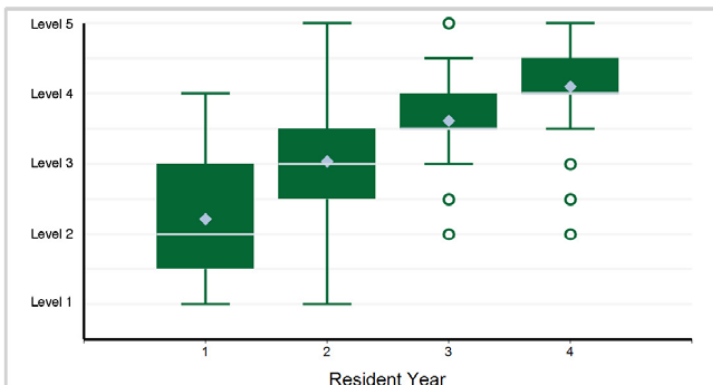

Note: 37 of 763 residents have a status of "Not Yet Rotated" and are not included in the analysis.

6. Patient Care - Gastrointestinal (GI) — Patient Care

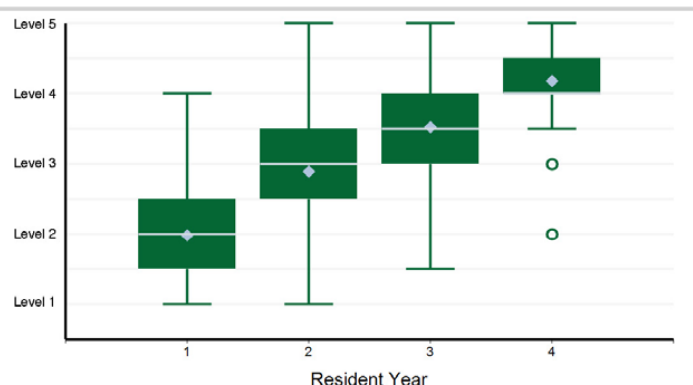

Note: 67 of 763 residents have a status of "Not Yet Rotated" and are not included in the analysis.

Specialty Box Plot Report - Milestone Evaluation by Resident Year: Year-End 2021-2022

SPECIALTY: Radiation Oncology

7. Patient Care - Gynecologic (GYN) — Patient Care

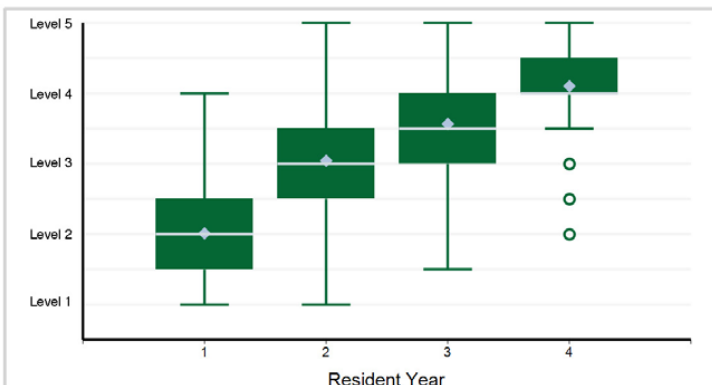

Note: 105 of 763 residents have a status of "Not Yet Rotated" and are not included in the analysis.

8. Patient Care - Lung — Patient Care

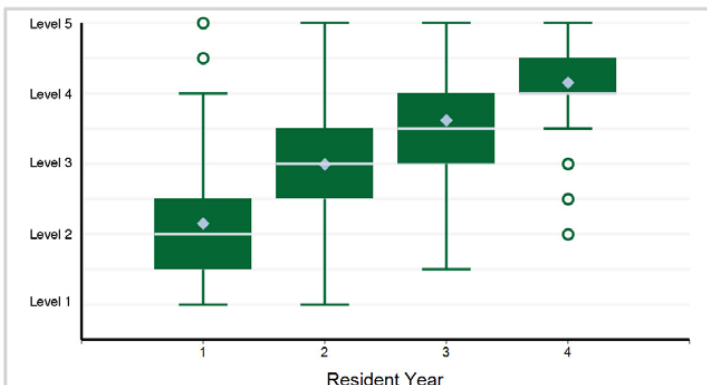

Note: 48 of 763 residents have a status of "Not Yet Rotated" and are not included in the analysis.

9. Patient Care - Adult Brain Tumor — Patient Care

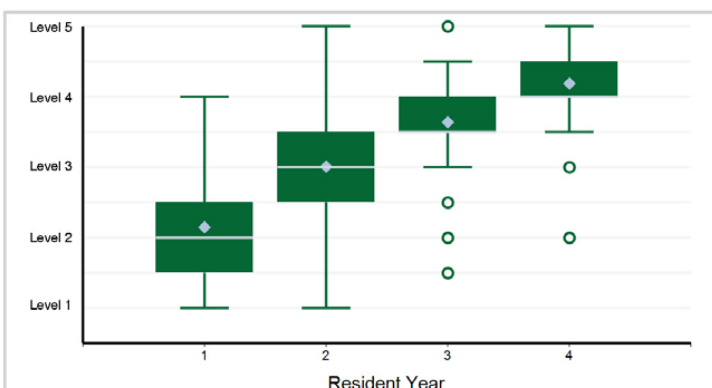

Note: 45 of 763 residents have a status of "Not Yet Rotated" and are not included in the analysis.

10. Patient Care - Brachytherapy — Patient Care

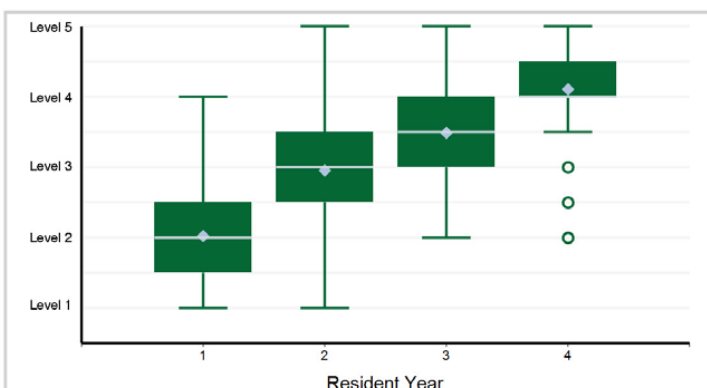

Note: 47 of 763 residents have a status of "Not Yet Rotated" and are not included in the analysis.

11. Patient Care - Stereotactic Radiosurgery (SRS)/Stereotactic Body Radiotherapy (SBRT) — Patient Care

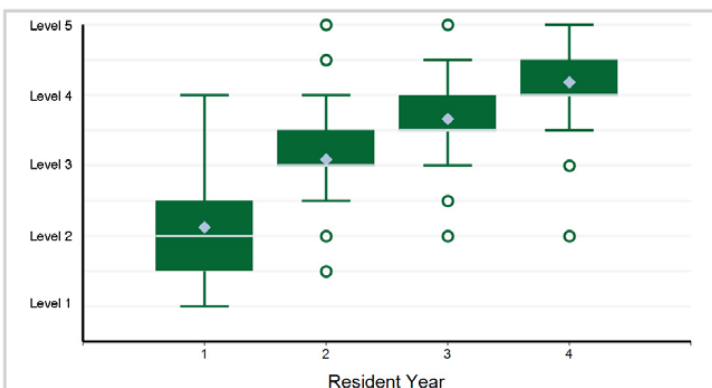

Note: 14 of 763 residents have a status of "Not Yet Rotated" and are not included in the analysis.

12. Medical Knowledge - Medical Physics — Medical Knowledge

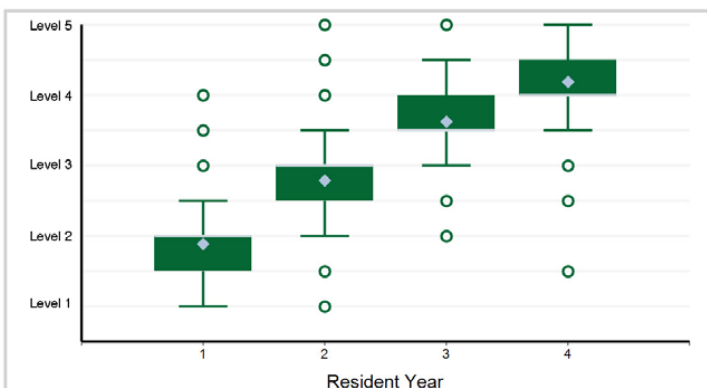

Note: 6 of 763 residents have a status of "Not Yet Rotated" and are not included in the analysis.

Specialty Box Plot Report - Milestone Evaluation by Resident Year: Year-End 2021-2022

SPECIALTY: Radiation Oncology

13. Medical Knowledge - Radiation/Cancer Biology — Medical Knowledge

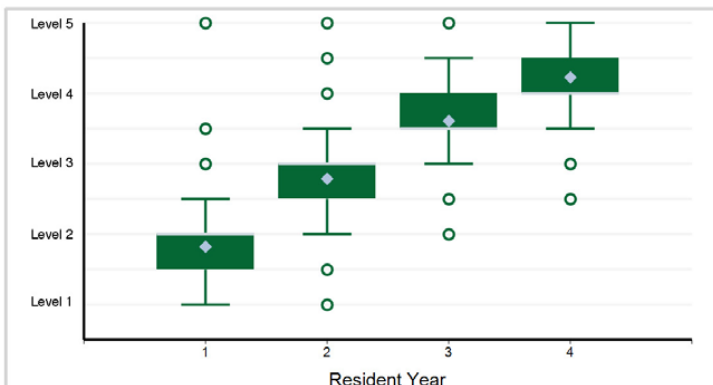

Note: 9 of 763 residents have a status of "Not Yet Rotated" and are not included in the analysis.

14. Systems-Based Practice - Work and coordinate patient care effectively in various health care delivery ...

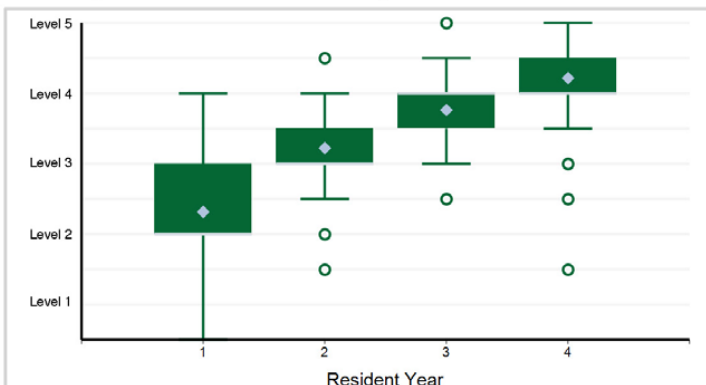

15. Systems-Based Practice - Incorporate considerations of cost awareness and risk-benefit analysis in patient- ...

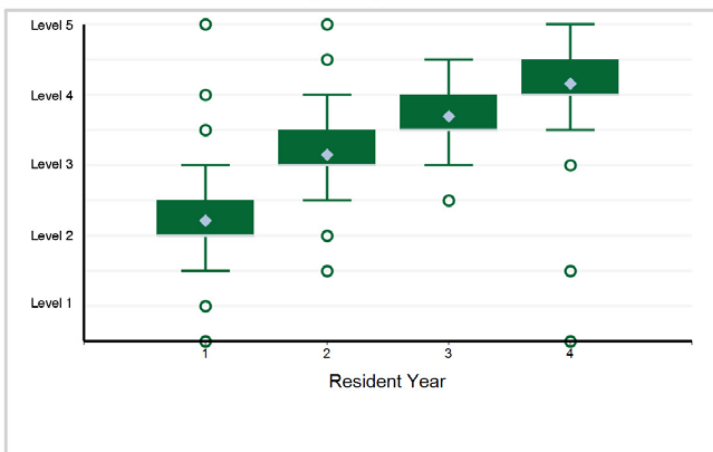

16. Systems-Based Practice - Work in interprofessional teams to enhance patient safety and improve patient ...

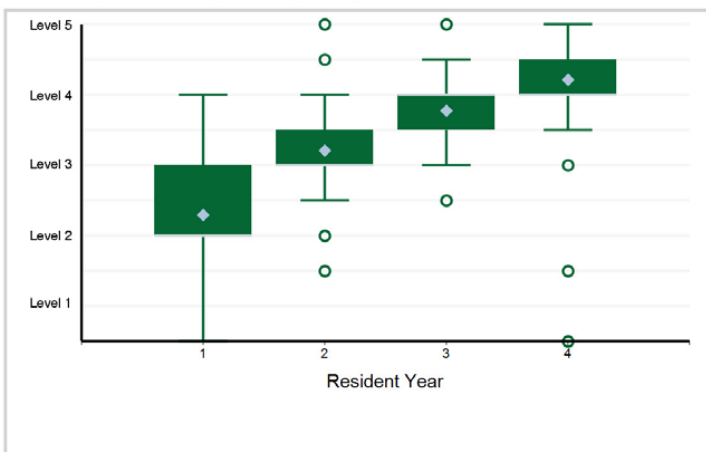

17. Practice-Based Learning and Improvement - Identify strengths, deficiencies, and limits in one's knowledge ...

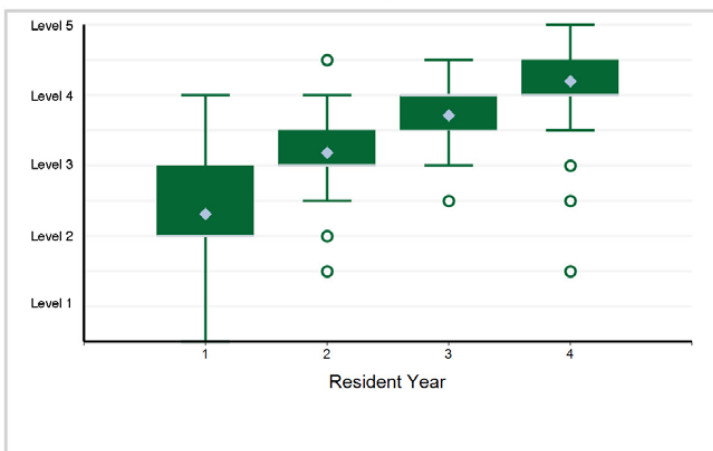

18. Practice-Based Learning and Improvement - Participate in the education of patients, families, students, ...

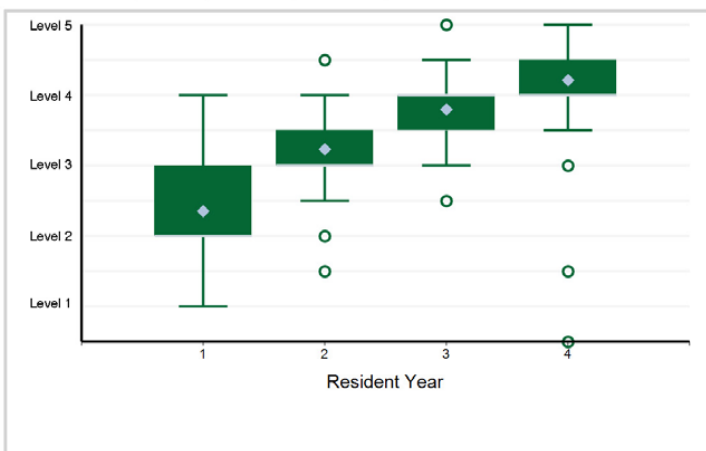

Specialty Box Plot Report - Milestone Evaluation by Resident Year: Year-End 2021-2022

SPECIALTY: Radiation Oncology

19. Professionalism - Compassion, integrity, and respect for others, as well as sensitivity and responsiveness ...

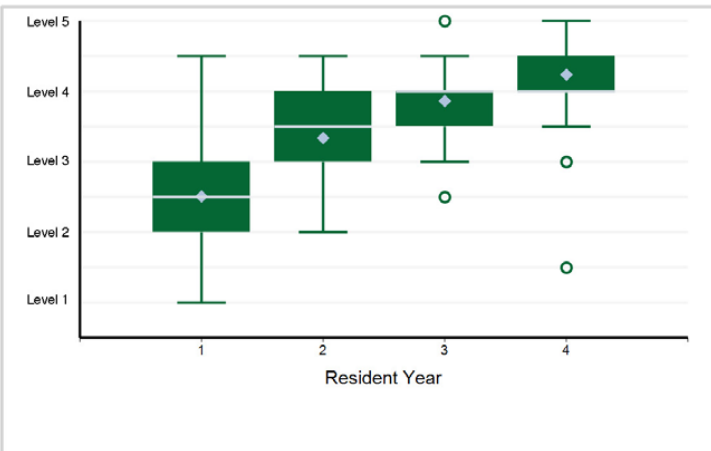

20. Professionalism - Accountability to patients, society, and the profession; personal responsibility to ...

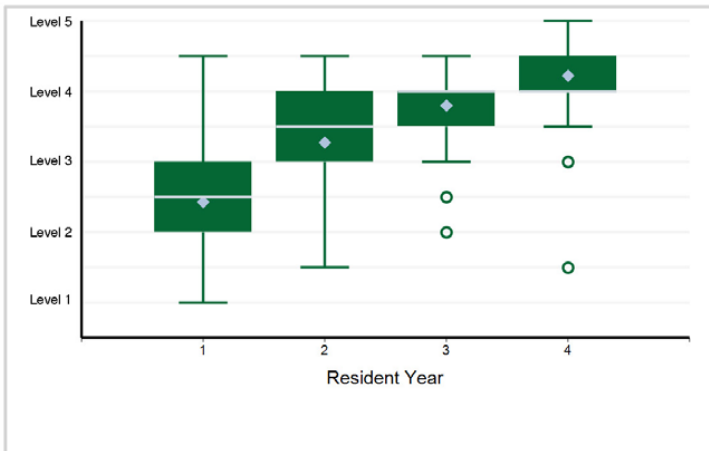

21. Interpersonal and Communication Skills - Effective communication with patients, families, and the public, ...

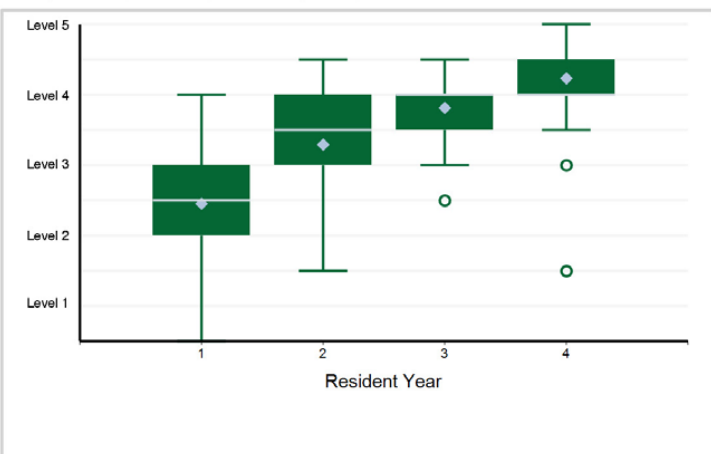

22. Interpersonal and Communication Skills - Effective member or leader of a health care team or other professional ...

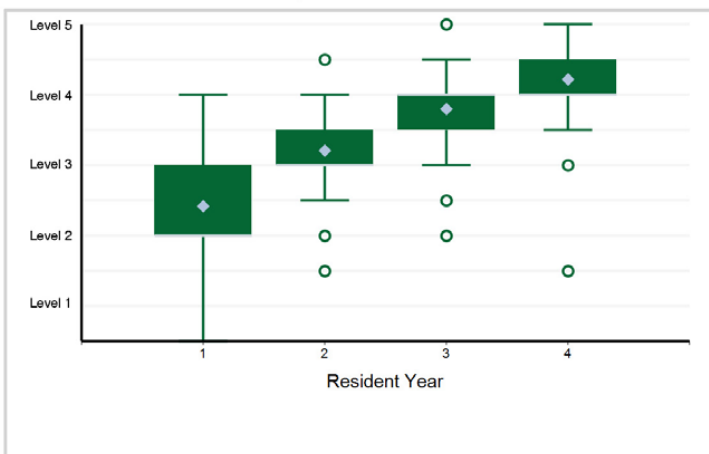

Specialty Box Plot Report - Milestone Evaluation by Resident Year: Year-End 2021-2022

TABLE 131: SPECIALTY: **Diagnostic Radiology**

Resident Year	1	2	3	4	Total Residents
# of Residents	1,135	1,123	1,102	1,073	4,433

1. Patient Care - Patient Care 1: Reporting

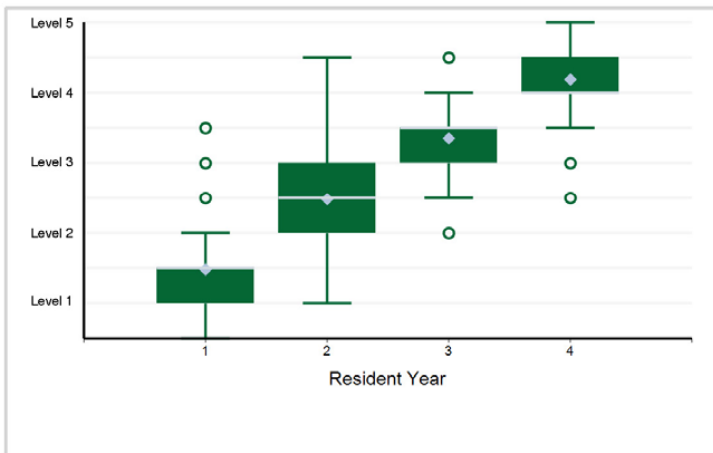

2. Patient Care - Patient Care 2: Clinical Consultation

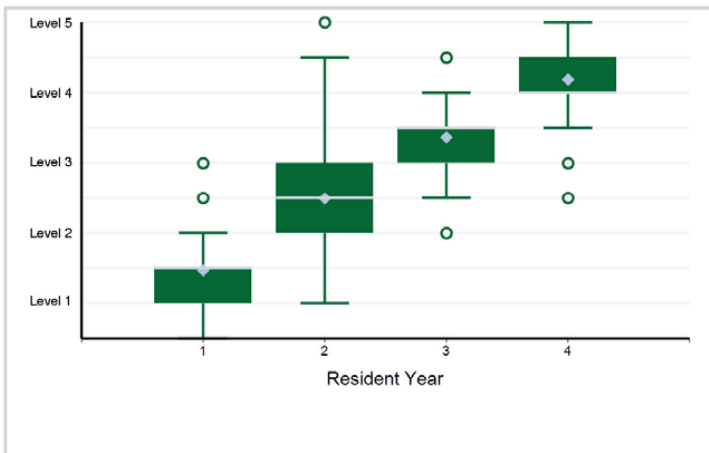

3. Patient Care - Patient Care 3: Image Interpretation

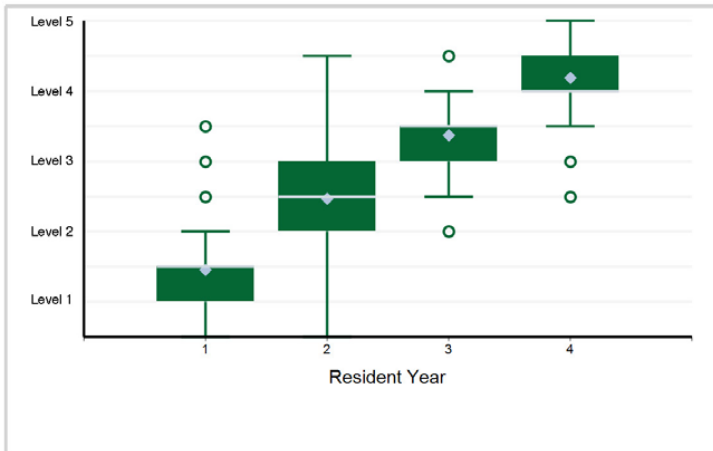

4. Patient Care - Patient Care 4: Competence in Procedures

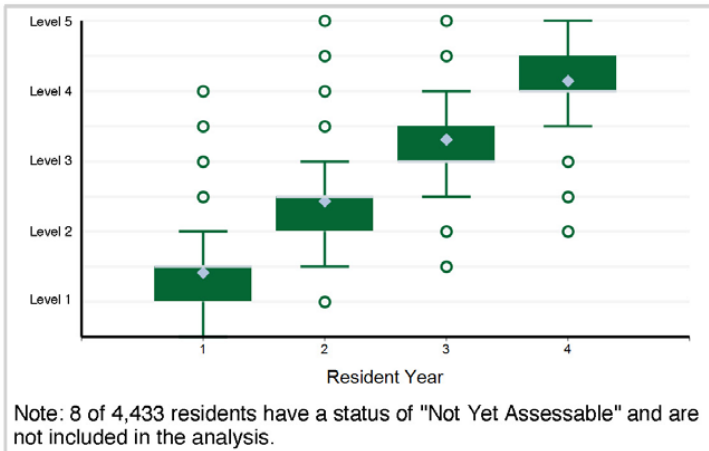

Note: 8 of 4,433 residents have a status of "Not Yet Assessable" and are not included in the analysis.

5. Medical Knowledge - Medical Knowledge 1: Diagnostic Knowledge

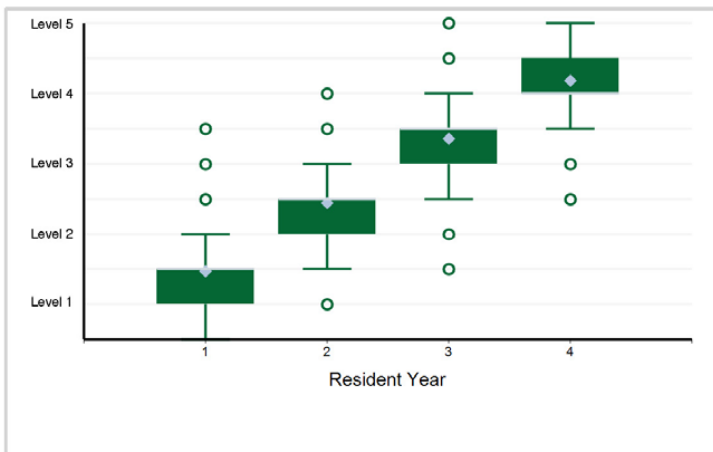

6. Medical Knowledge - Medical Knowledge 2: Physics

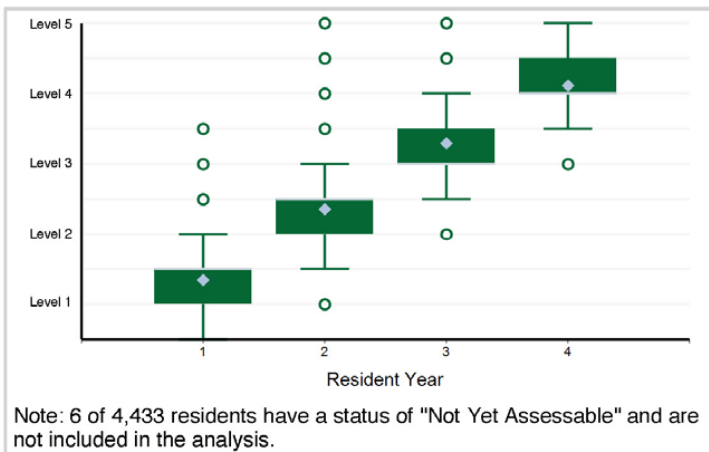

Note: 6 of 4,433 residents have a status of "Not Yet Assessable" and are not included in the analysis.

Specialty Box Plot Report - Milestone Evaluation by Resident Year: Year-End 2021-2022

SPECIALTY: Diagnostic Radiology

7. Medical Knowledge - Medical Knowledge 3: Protocol Selection and Contrast Agent Selection/Dosing

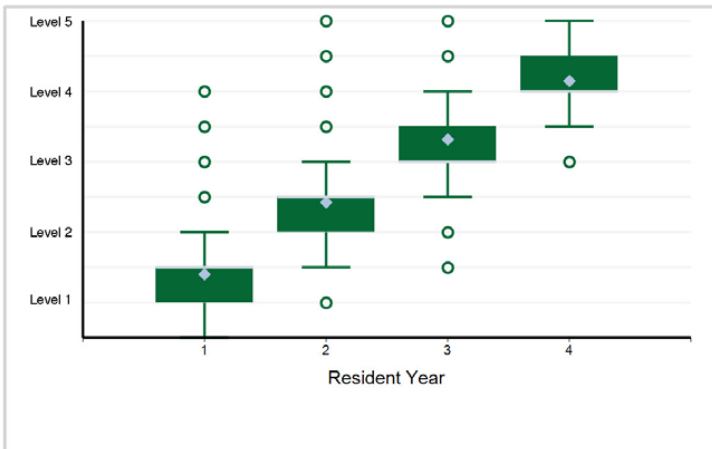

8. Medical Knowledge - Medical Knowledge 4: Imaging Technology and Image Acquisition

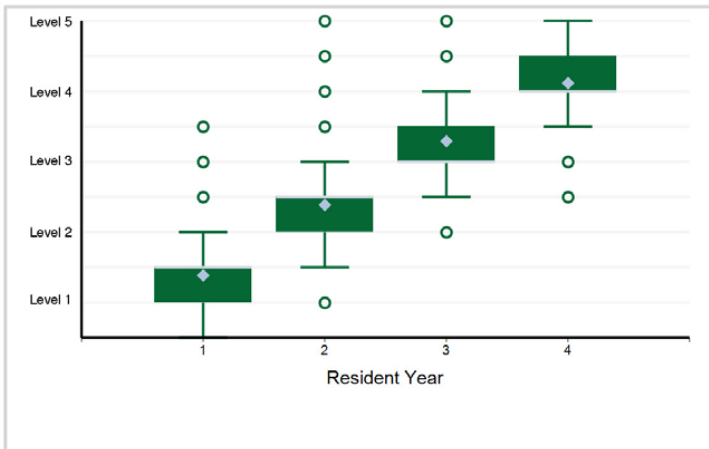

9. Systems-Based Practice - Systems-Based Practice 1: Patient Safety

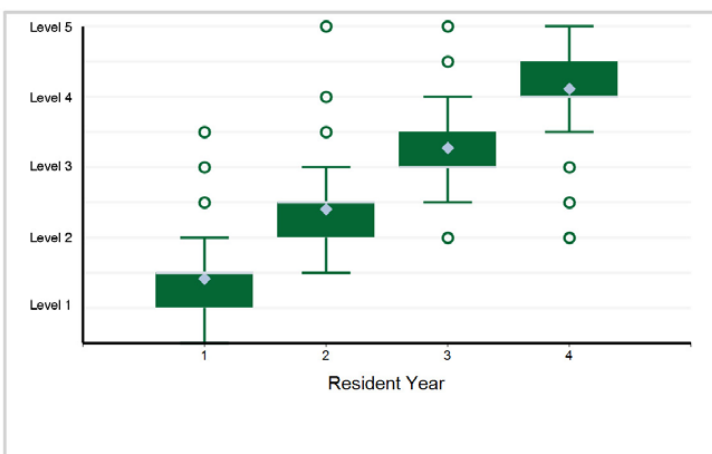

10. Systems-Based Practice - Systems-Based Practice 2: Quality Improvement

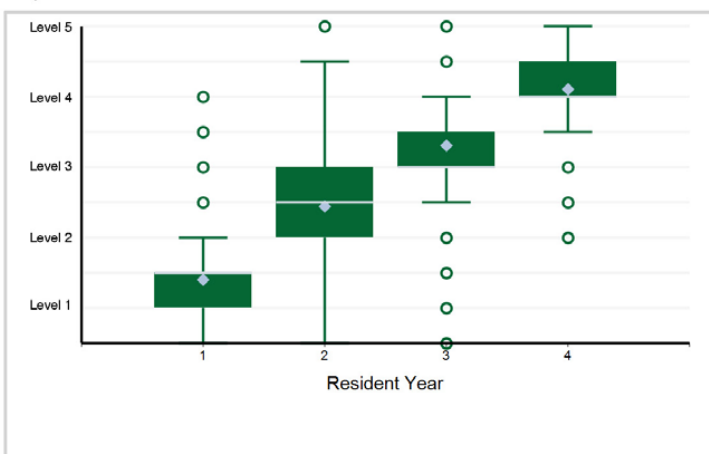

11. Systems-Based Practice - Systems-Based Practice 3: System Navigation for Patient-Centered Care

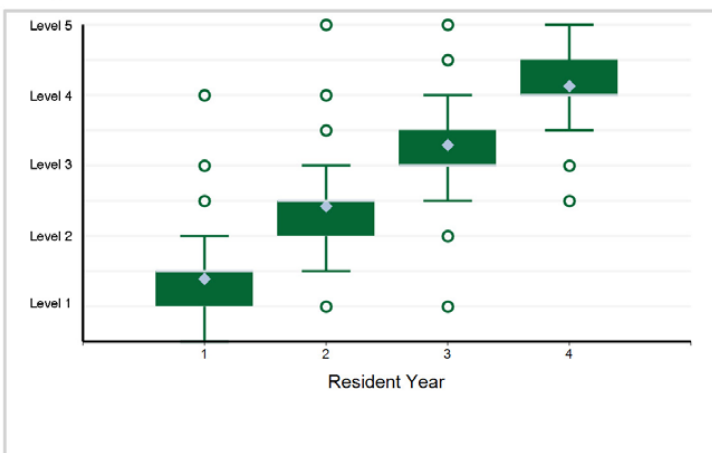

12. Systems-Based Practice - Systems-Based Practice 4: Physician Role in Health Care Systems

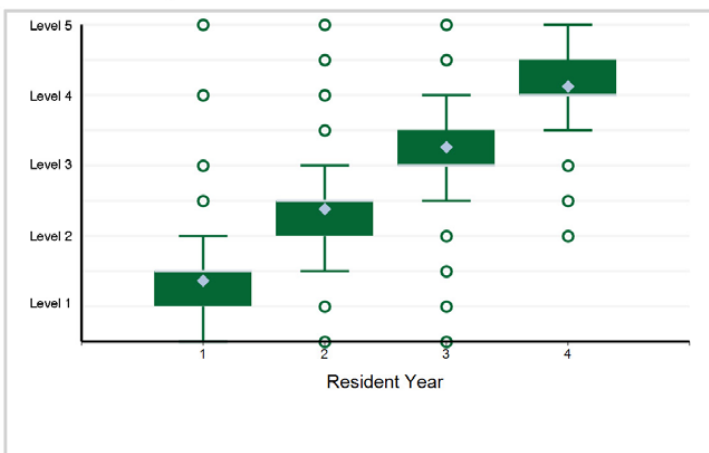

Specialty Box Plot Report - Milestone Evaluation by Resident Year: Year-End 2021-2022

SPECIALTY: Diagnostic Radiology

13. Systems-Based Practice - Systems-Based Practice 5: Contrast Agent Safety

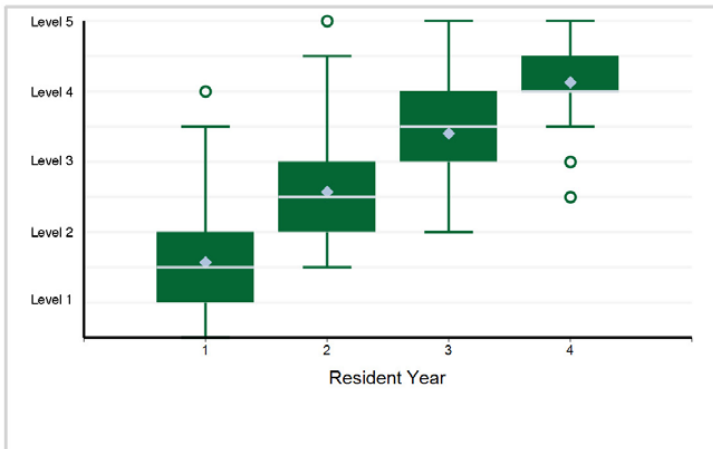

14. Systems-Based Practice - Systems-Based Practice 6: Radiation Safety

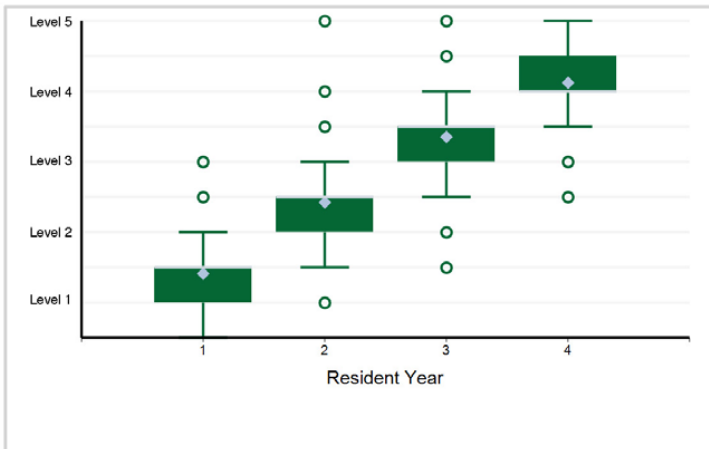

15. Systems-Based Practice - Systems-Based Practice 7: Magnetic Resonance (MR) Safety

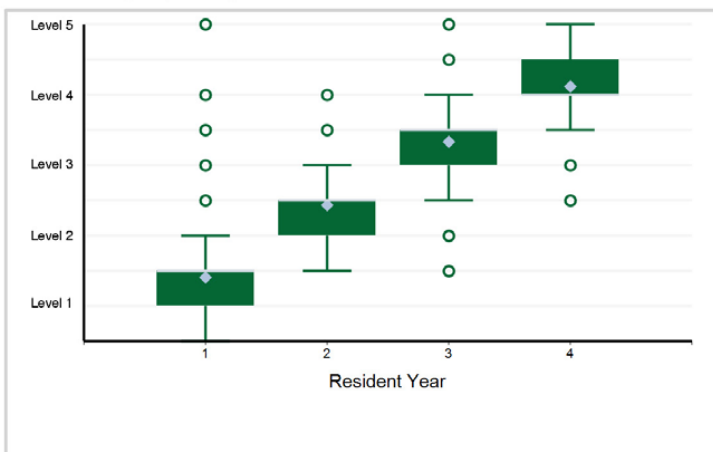

16. Systems-Based Practice - Systems-Based Practice 8: Informatics

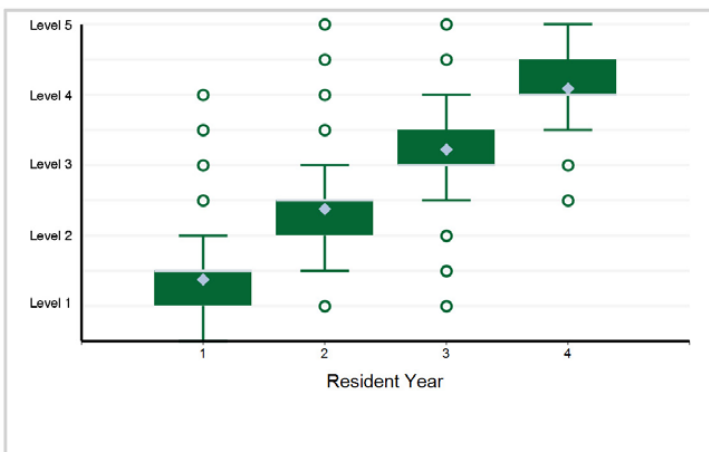

17. Practice-Based Learning and Improvement - Practice-Based Learning and Improvement 1: Evidence-Based and Informed Practice

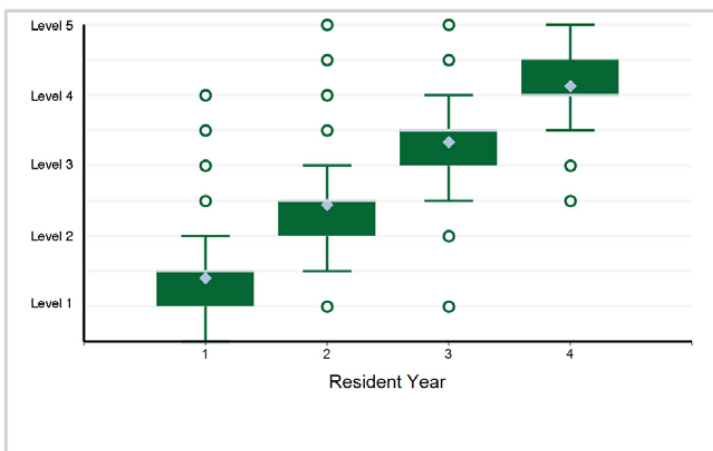

18. Practice-Based Learning and Improvement - Practice-Based Learning and Improvement 2: Reflective Practice and Commitment ...

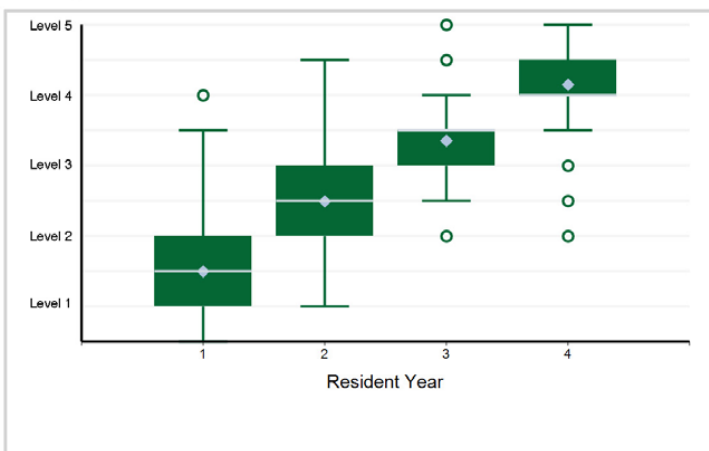

Specialty Box Plot Report - Milestone Evaluation by Resident Year: Year-End 2021-2022

SPECIALTY: Diagnostic Radiology

19. Professionalism - Professionalism 1: Professional Behavior and Ethical Principles

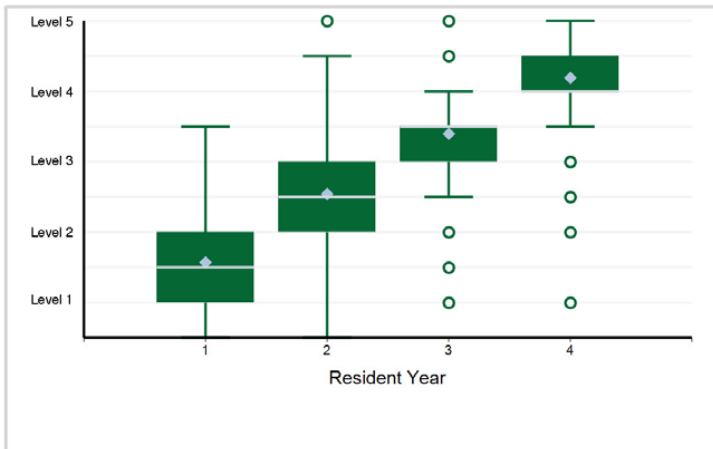

20. Professionalism - Professionalism 2: Accountability/Conscientiousness

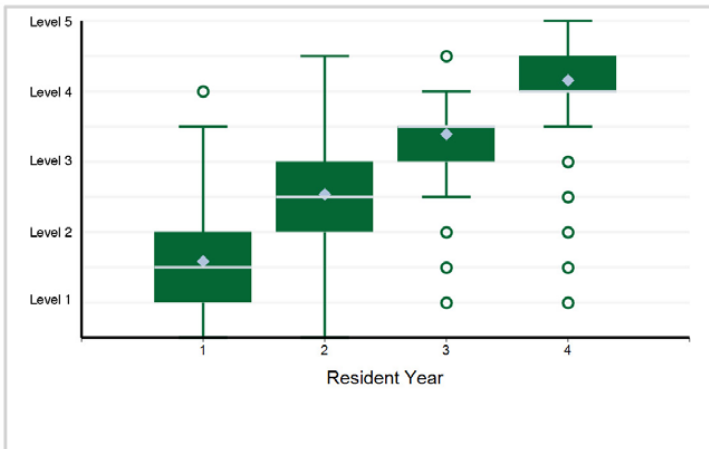

21. Professionalism - Professionalism 3: Self-Awareness and Help Seeking

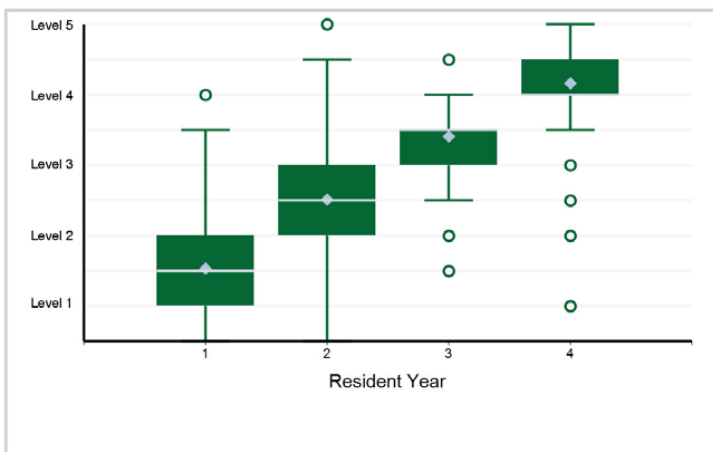

22. Interpersonal and Communication Skills - Interpersonal and Communication Skills 1: Patient- and Family-Centered Communication

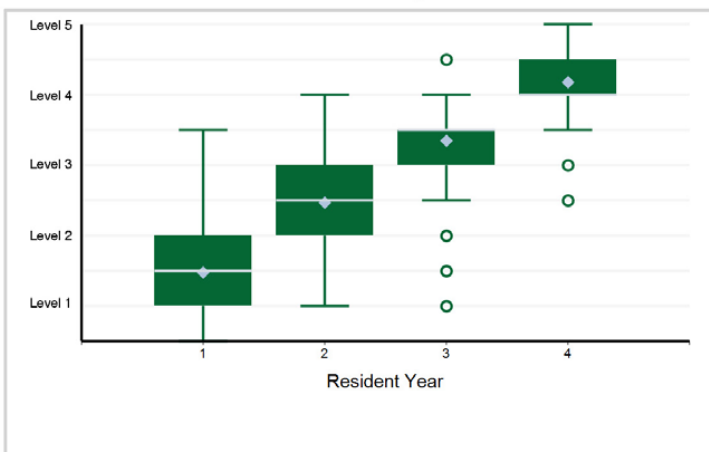

23. Interpersonal and Communication Skills - Interpersonal and Communication Skills 2: Interprofessional and Team Communication

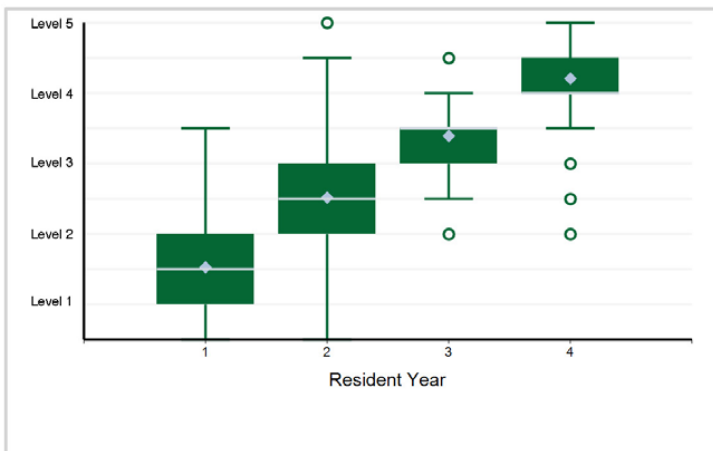

24. Interpersonal and Communication Skills - Interpersonal and Communication Skills 3: Communication within Health Care Systems

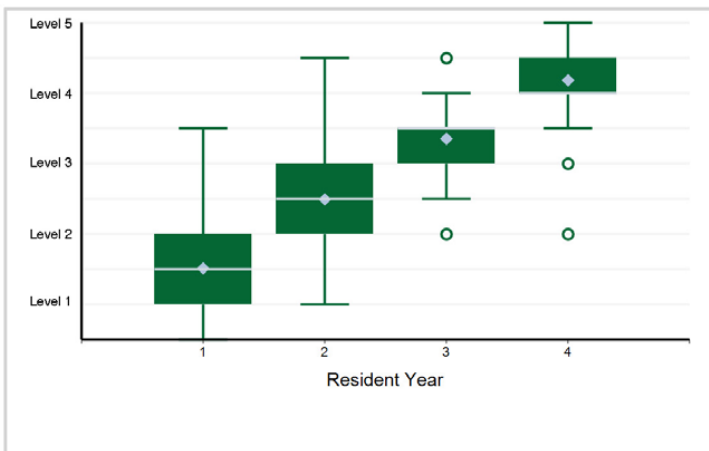

Specialty Box Plot Report - Milestone Evaluation by Resident Year: Year-End 2021-2022

TABLE 132: SUBSPECIALTY: **Abdominal Radiology**

Resident Year	1	Total Residents
# of Residents	52	52

1. Patient Care - Consultant — Patient Care 1



2. Patient Care - Competence in Procedures — Patient Care 2



3. Patient Care - Patient Safety — Patient Care 3



4. Medical Knowledge - Protocol Selection and Optimization of Imaging — Medical Knowledge 1

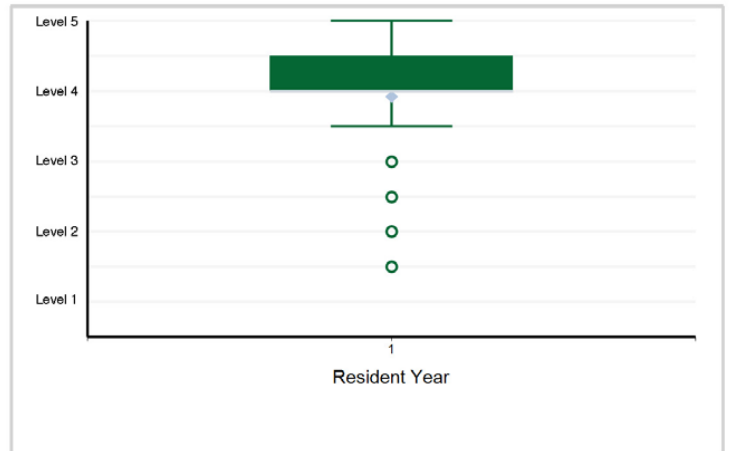

5. Medical Knowledge - Interpretation — Medical Knowledge 2

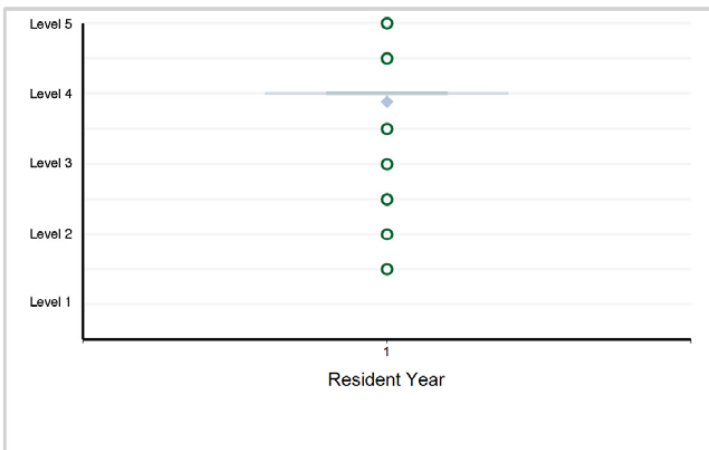

6. Systems-Based Practice - Quality Improvement (QI) — Systems-Based Practice 1

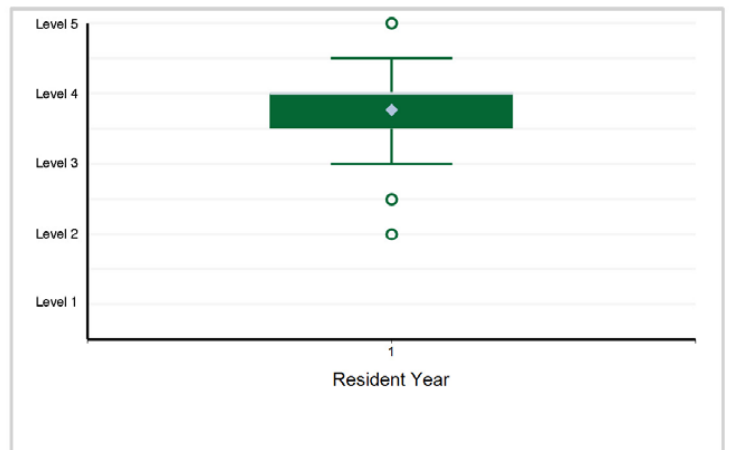

Specialty Box Plot Report - Milestone Evaluation by Resident Year: Year-End 2021-2022

SUBSPECIALTY: Abdominal Radiology

7. Systems-Based Practice - Health Care Economics — Systems-Based Practice 2



8. Practice-Based Learning and Improvement - Self-directed learning — Practice-Based Learning and Improvement 1



9. Practice-Based Learning and Improvement - Scholarly Activity — Practice-Based Learning and Improvement 2



10. Professionalism - Individual — Professionalism 1

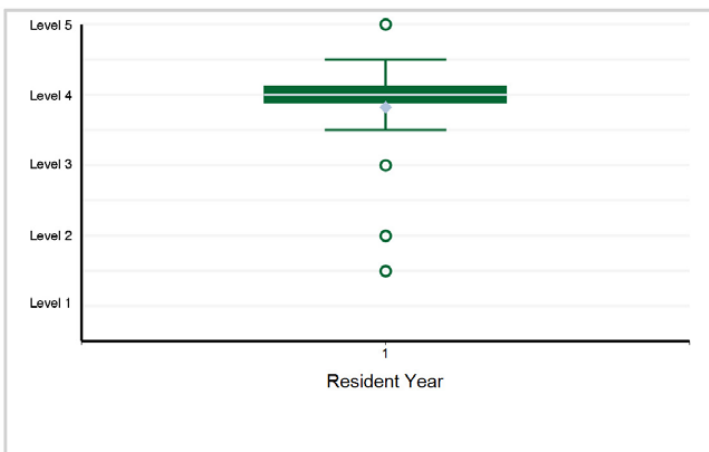

11. Professionalism - Systems — Professionalism 2



12. Interpersonal and Communication Skills - Effective Communication with Patients, Families, and Caregivers ...



Specialty Box Plot Report - Milestone Evaluation by Resident Year: Year-End 2021-2022

SUBSPECIALTY: **Abdominal Radiology**

13. Interpersonal and Communication Skills - Effective communication with members of the health care team ...



Specialty Box Plot Report - Milestone Evaluation by Resident Year: Year-End 2021-2022

TABLE 133: SUBSPECIALTY: **Musculoskeletal Radiology**

Resident Year	1	Total Residents
# of Residents	39	39

1. Patient Care - Patient Care 1: Consultant

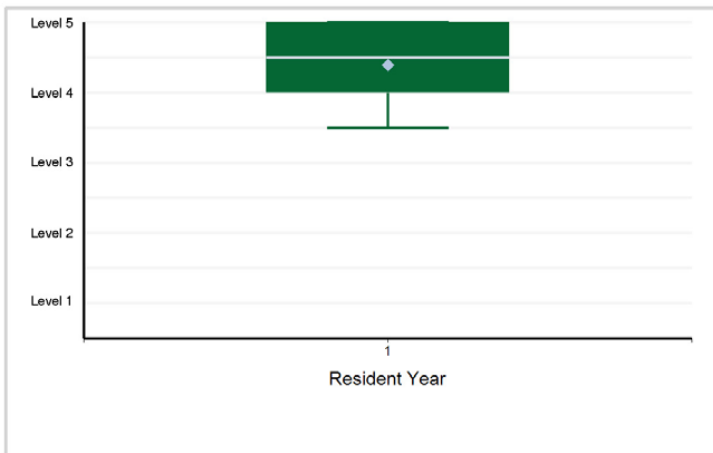

2. Patient Care - Patient Care 2: Diagnostic and Therapeutic Procedures

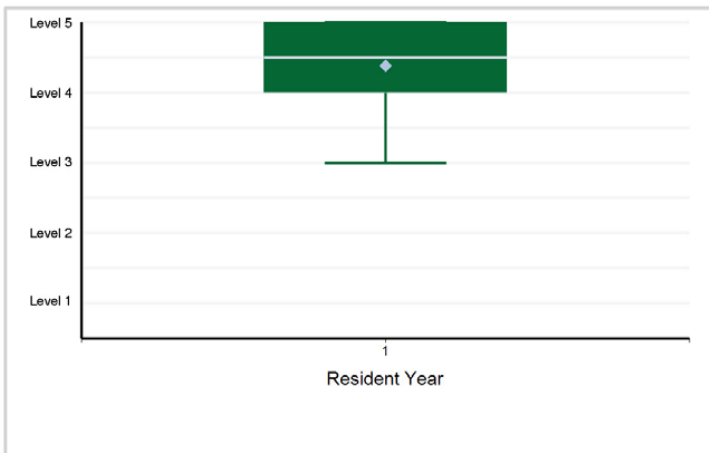

3. Patient Care - Patient Care 3: Musculoskeletal Radiology Reporting

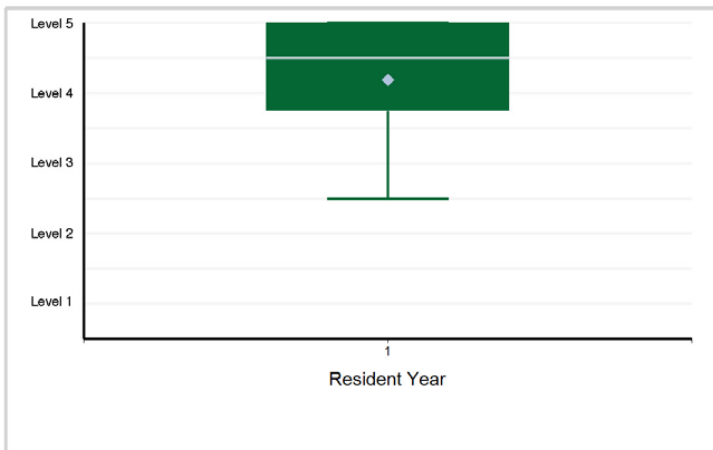

4. Medical Knowledge - Medical Knowledge 1: Image Interpretation – Anatomy and Physiology

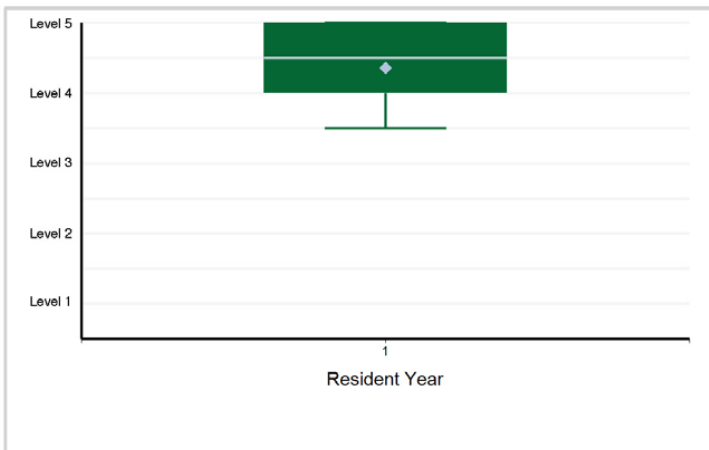

5. Medical Knowledge - Medical Knowledge 2: Image Interpretation – Diagnosis

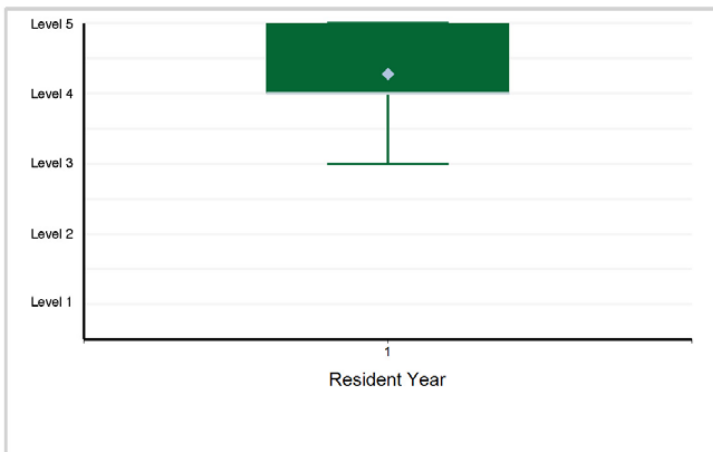

6. Medical Knowledge - Medical Knowledge 3: Protocols

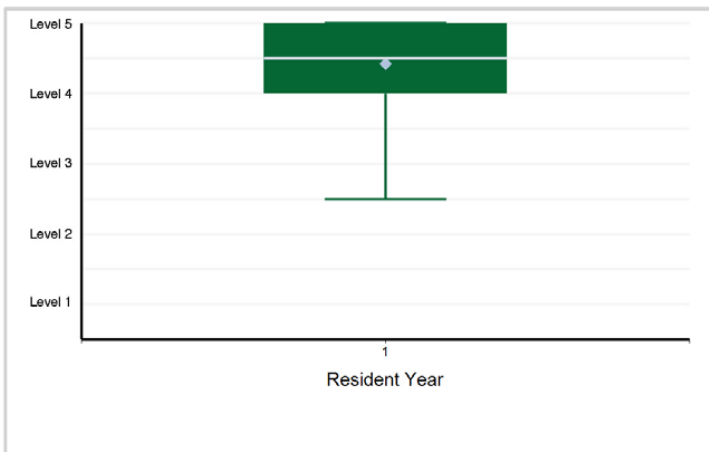

Specialty Box Plot Report - Milestone Evaluation by Resident Year: Year-End 2021-2022

SUBSPECIALTY: Musculoskeletal Radiology

7. Systems-Based Practice - Systems-Based Practice 1: Patient Safety

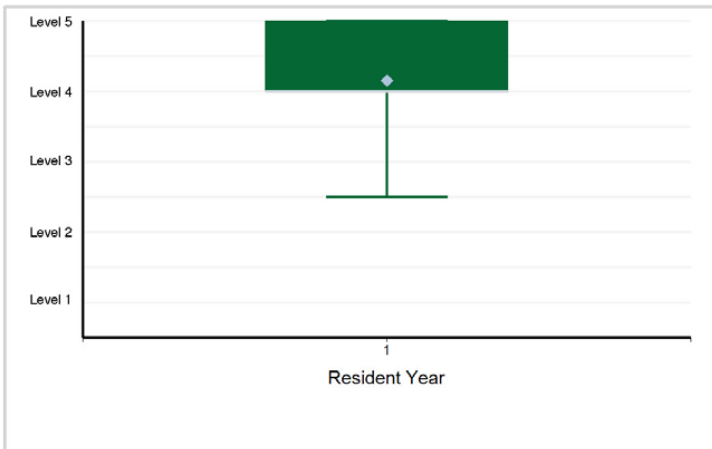

8. Systems-Based Practice - Systems-Based Practice 2: Quality Improvement

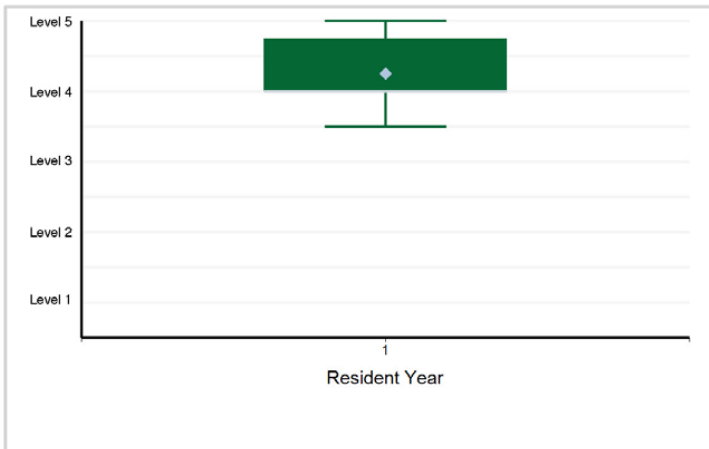

9. Systems-Based Practice - Systems-Based Practice 3: System Navigation for Patient-Centered Care

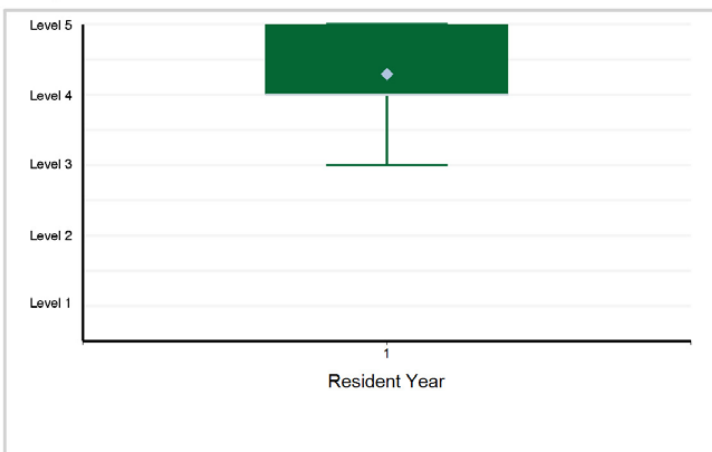

10. Systems-Based Practice - Systems-Based Practice 4: Physician Role in Health Care Systems

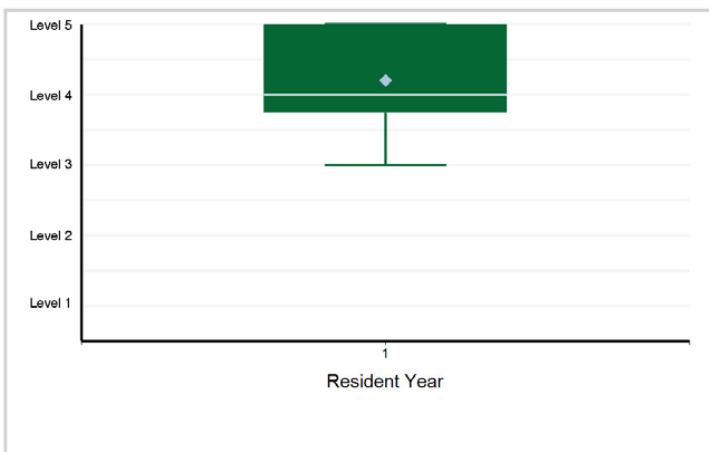

11. Systems-Based Practice - Systems-Based Practice 5: Contrast Agent Safety

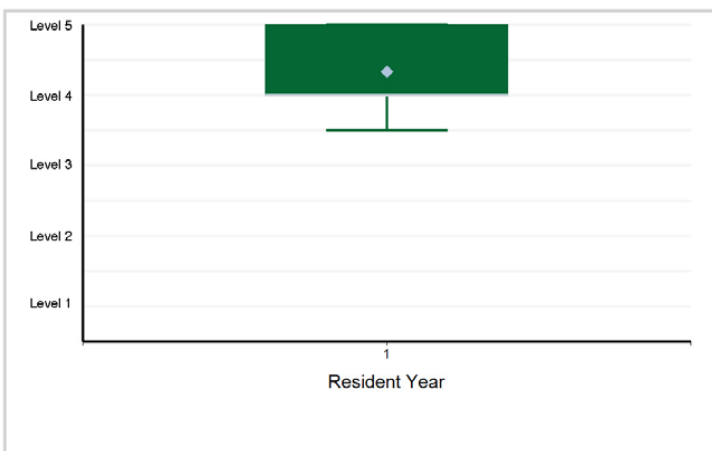

12. Systems-Based Practice - Systems-Based Practice 6: Radiation Safety

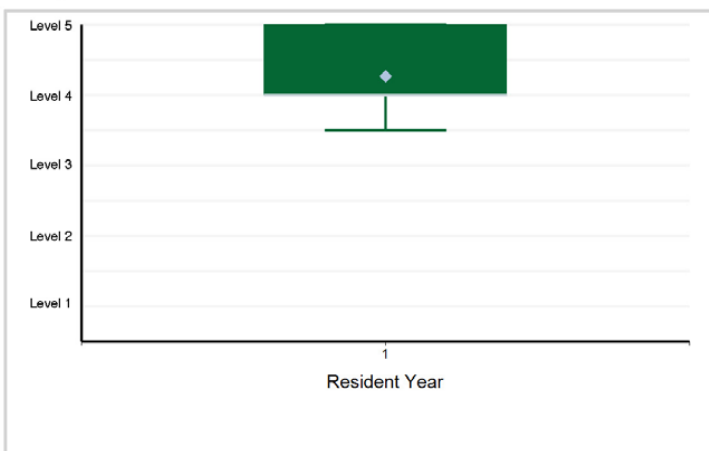

Specialty Box Plot Report - Milestone Evaluation by Resident Year: Year-End 2021-2022

SUBSPECIALTY: Musculoskeletal Radiology

13. Systems-Based Practice - Systems-Based Practice 7: Magnetic Resonance (MR) Safety

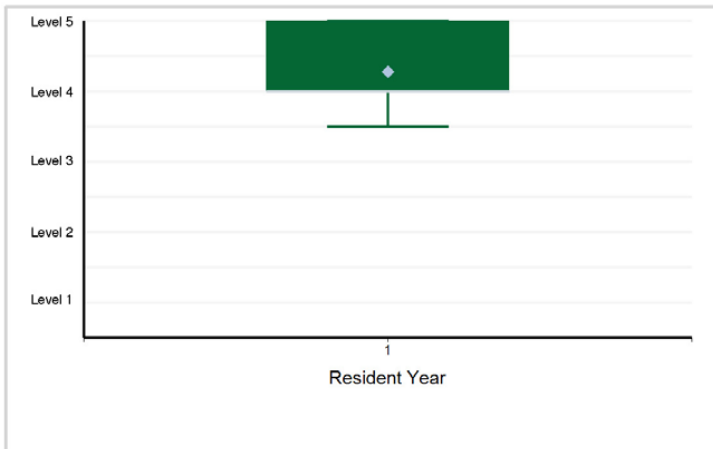

14. Systems-Based Practice - Systems-Based Practice 8: Informatics

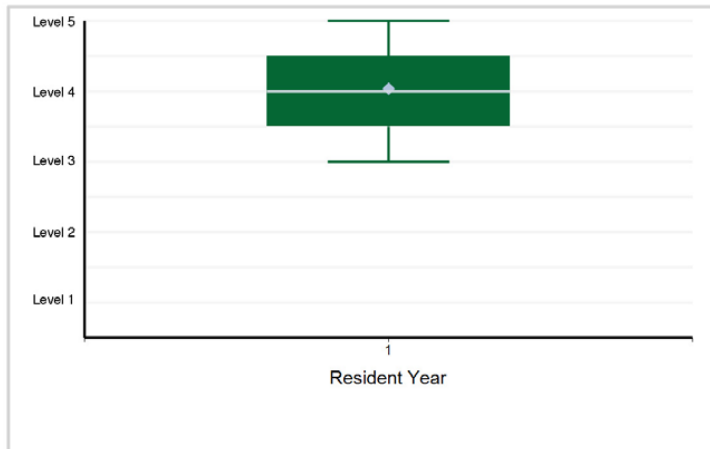

15. Practice-Based Learning and Improvement - Practice-Based Learning and Improvement 1: Evidence-Based and Informed Practice

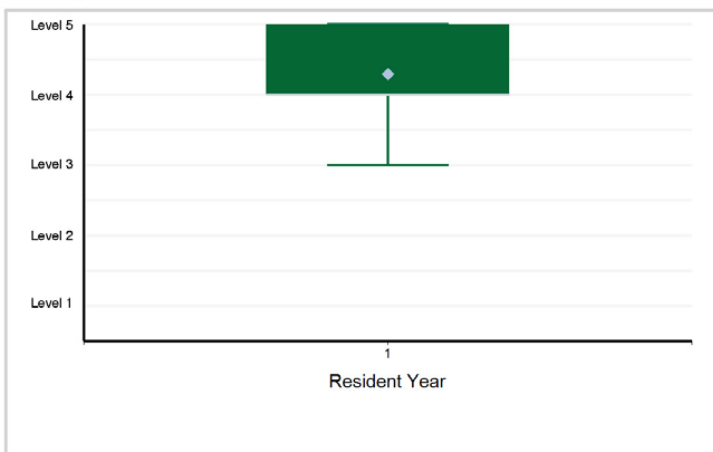

16. Practice-Based Learning and Improvement - Practice-Based Learning and Improvement 2: Reflective Practice and Commitment ...

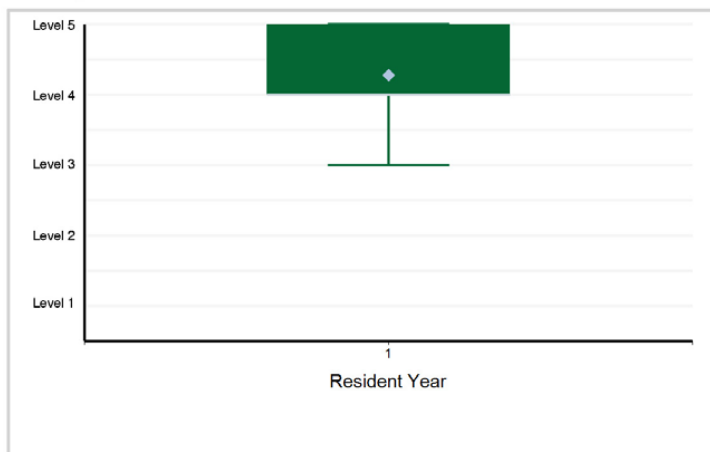

17. Professionalism - Professionalism 1: Professional Behavior and Ethical Principles

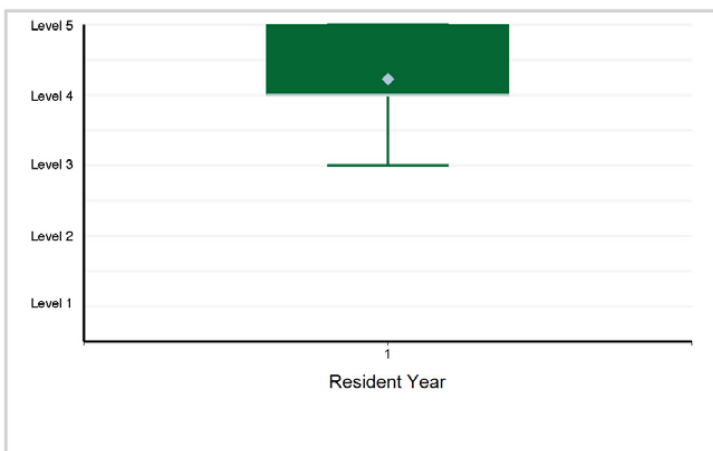

18. Professionalism - Professionalism 2: Accountability/Conscientiousness

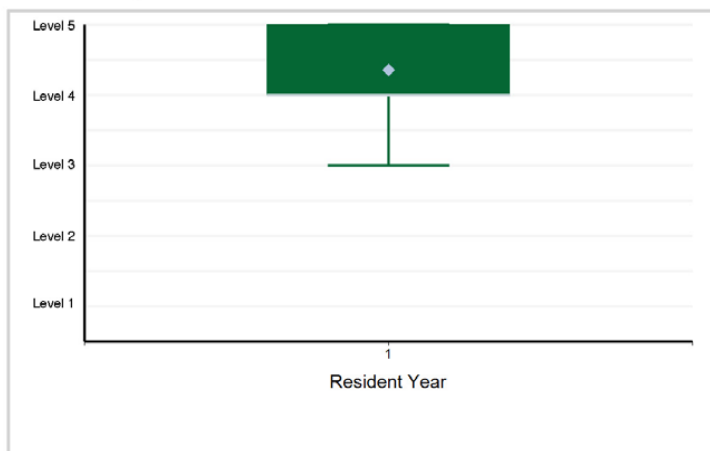

Specialty Box Plot Report - Milestone Evaluation by Resident Year: Year-End 2021-2022

SUBSPECIALTY: Musculoskeletal Radiology

19. Professionalism - Professionalism 3: Self-Awareness and Help-Seeking

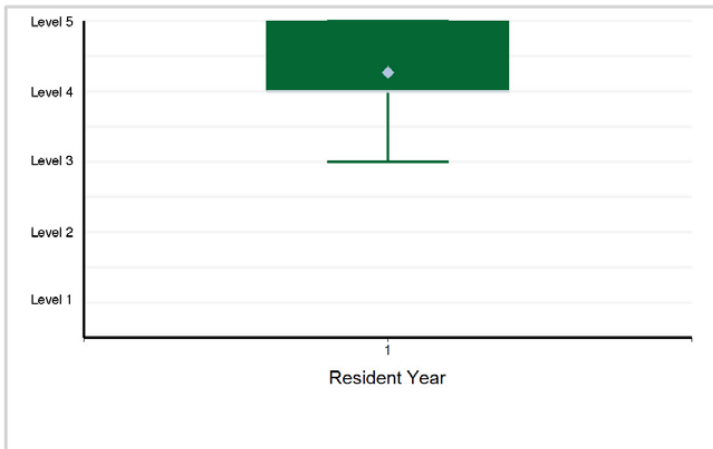

20. Interpersonal and Communication Skills - Interpersonal and Communication Skills 1: Patient- and Family-Centered Communication

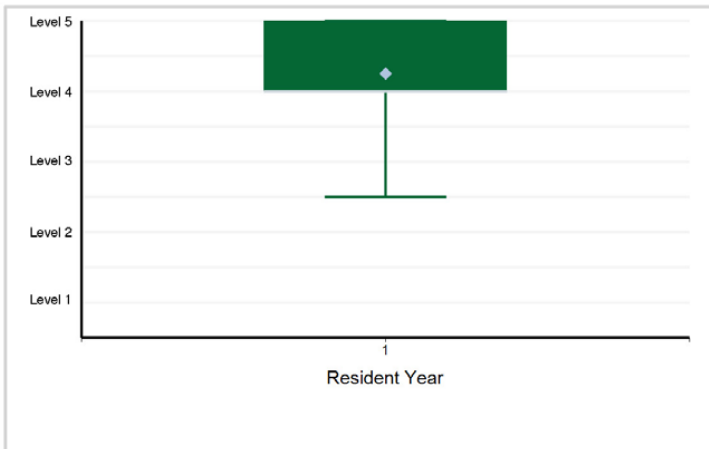

21. Interpersonal and Communication Skills - Interpersonal and Communication Skills 2: Interprofessional and Team Communication

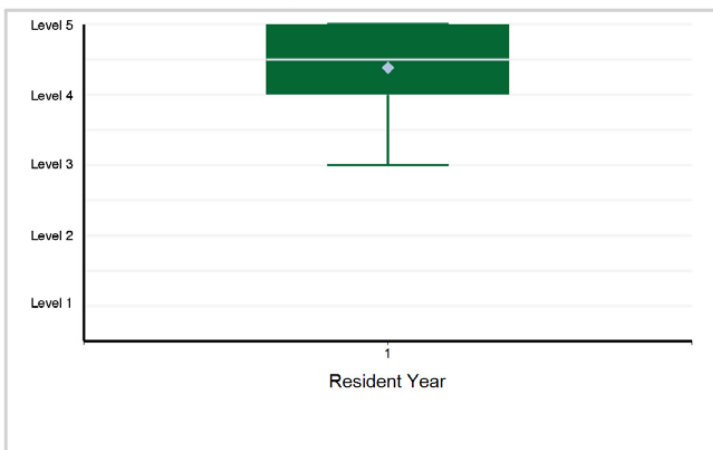

22. Interpersonal and Communication Skills - Interpersonal and Communication Skills 3: Communication within Health Care Systems

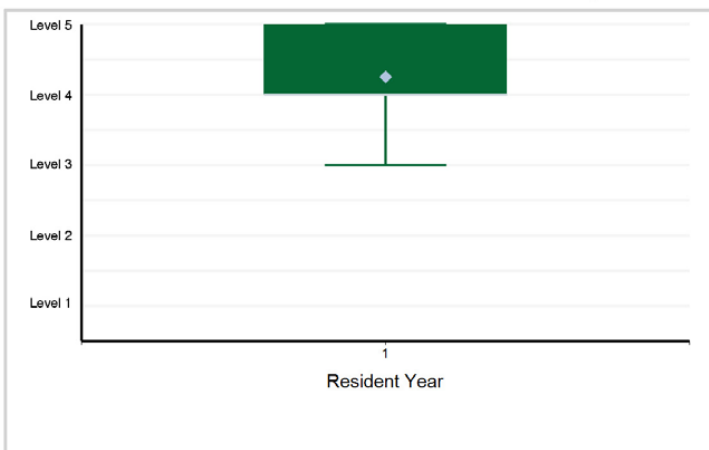

Specialty Box Plot Report - Milestone Evaluation by Resident Year: Year-End 2021-2022

TABLE 134: SUBSPECIALTY: **Neuroradiology**

Resident Year	1	Total Residents
# of Residents	296	296

1. Patient Care - Patient Care 1: Reporting

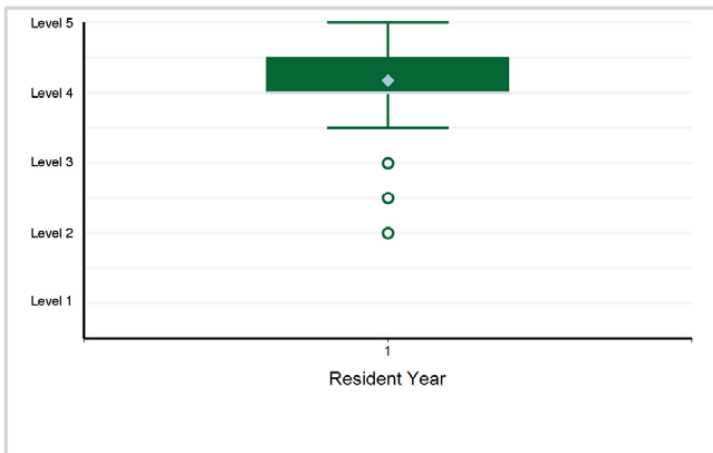

2. Patient Care - Patient Care 2: Consultant in Neuroradiology

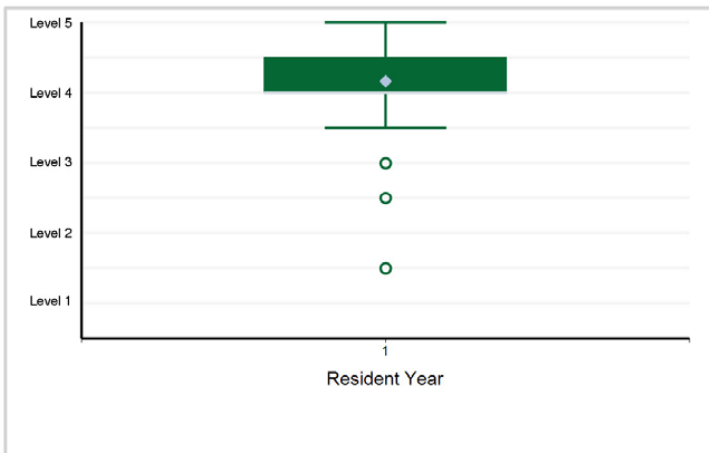

3. Patient Care - Patient Care 3: Interpretation of Neuroimaging

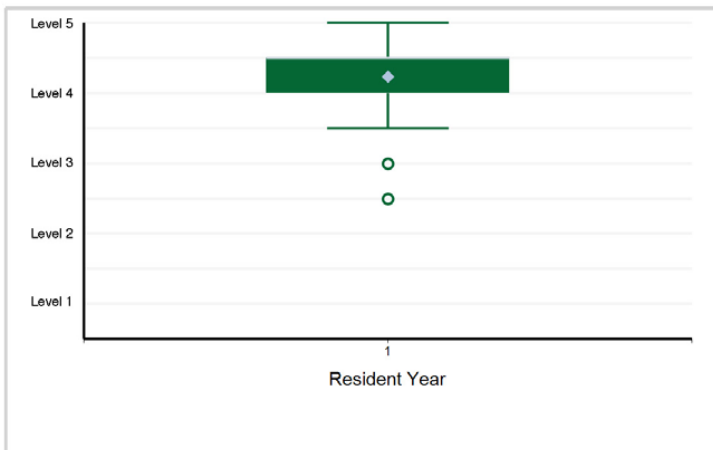

4. Patient Care - Patient Care 4: Competence in Neuroradiology Procedures

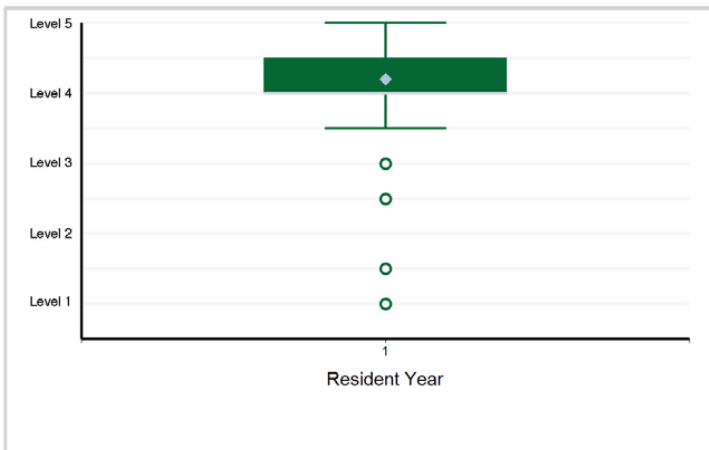

5. Medical Knowledge - Medical Knowledge 1: Application of Neuroscience to Neuroradiology

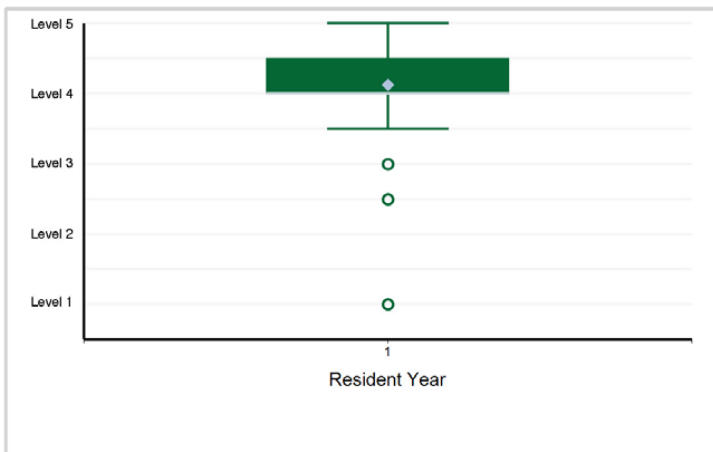

6. Medical Knowledge - Medical Knowledge 2: Protocol Selection, Contrast Agent Selection/Dosing, and Image Optimization

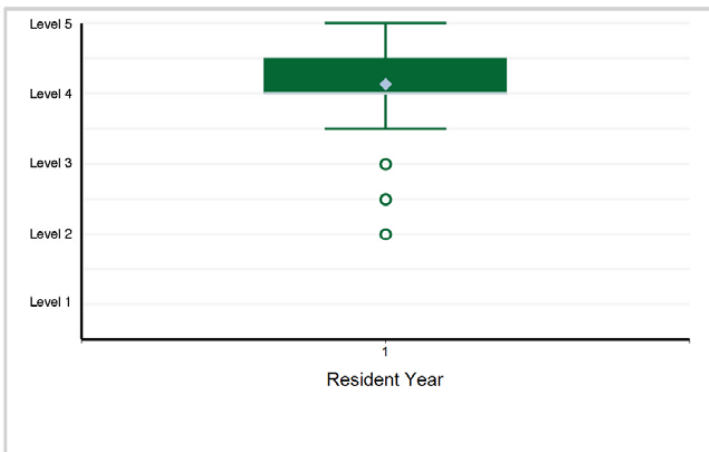

Specialty Box Plot Report - Milestone Evaluation by Resident Year: Year-End 2021-2022

SUBSPECIALTY: **Neuroradiology**

7. Systems-Based Practice - Systems-Based Practice 1: Patient Safety

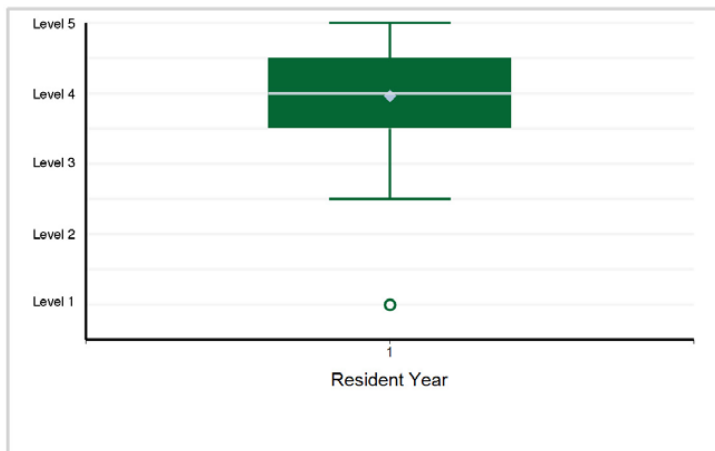

8. Systems-Based Practice - Systems-Based Practice 2: Quality Improvement

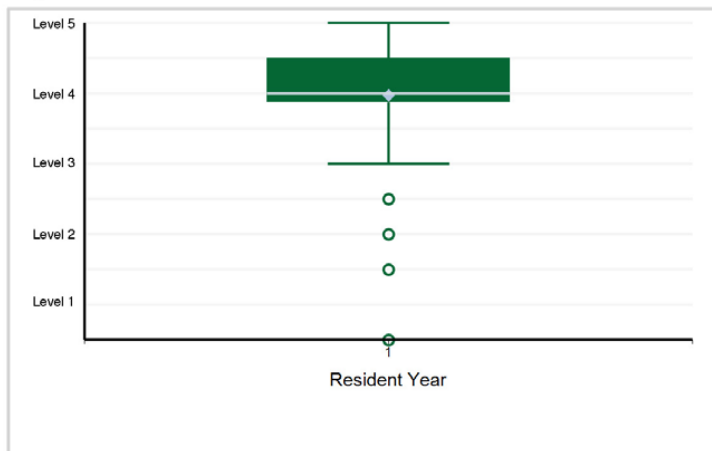

9. Systems-Based Practice - Systems-Based Practice 3: System Navigation for Patient-Centered Care

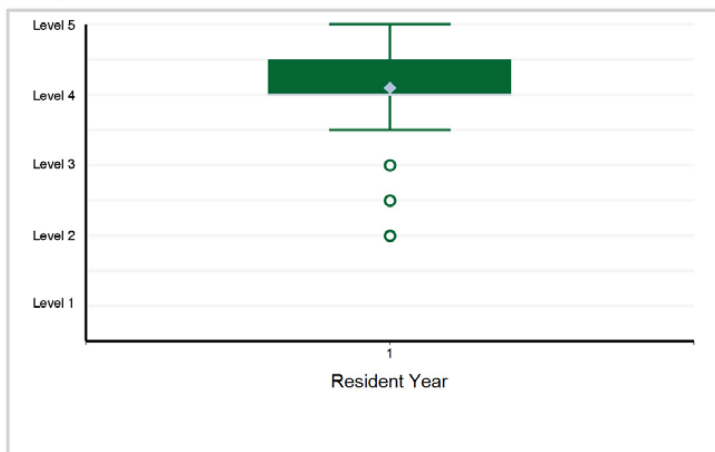

10. Systems-Based Practice - Systems-Based Practice 4: Physician Role in Health Care Systems

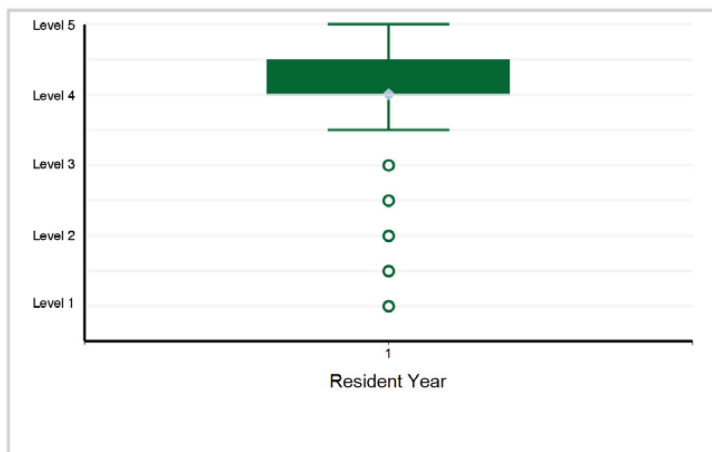

11. Systems-Based Practice - Systems-Based Practice 5: Contrast Agent Safety

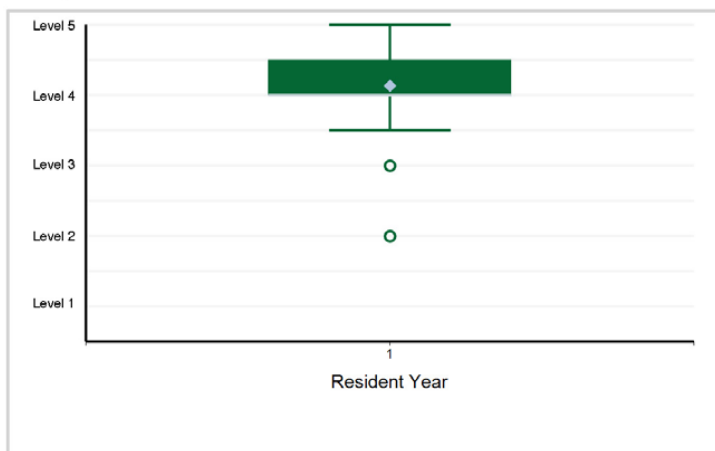

12. Systems-Based Practice - Systems-Based Practice 6: Radiation Safety



Specialty Box Plot Report - Milestone Evaluation by Resident Year: Year-End 2021-2022

SUBSPECIALTY: **Neuroradiology**

13. Systems-Based Practice - Systems-Based Practice 7: Magnetic Resonance (MR) Safety

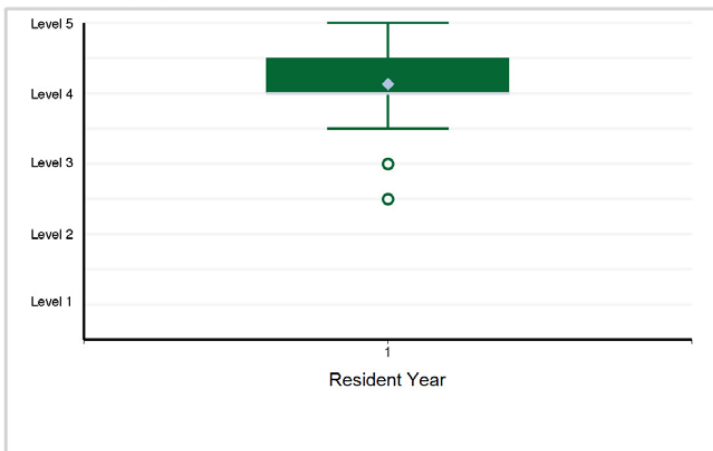

14. Practice-Based Learning and Improvement - Practice-Based Learning and Improvement 1: Evidence-Based and Informed Practice

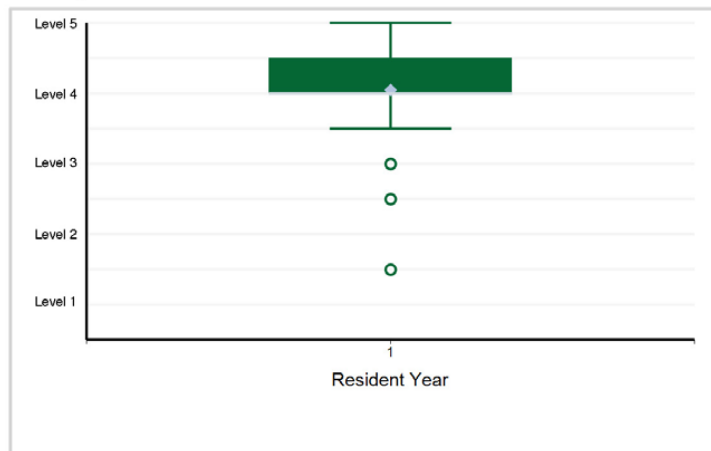

15. Practice-Based Learning and Improvement - Practice-Based Learning and Improvement 2: Reflective Practice and Commitment ...

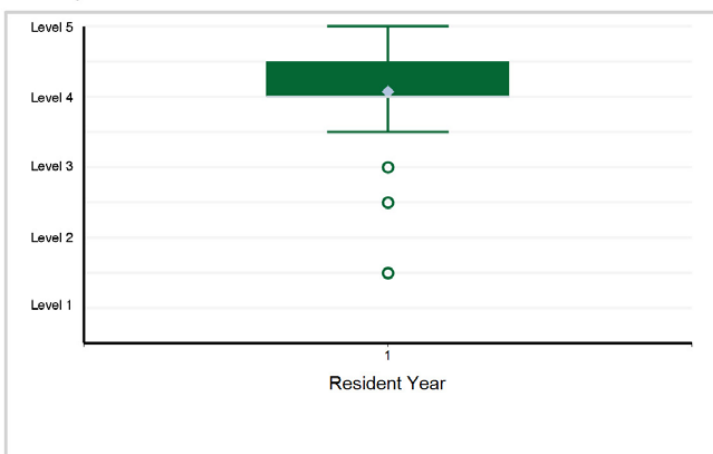

16. Professionalism - Professionalism 1: Professional Behavior and Ethical Principles

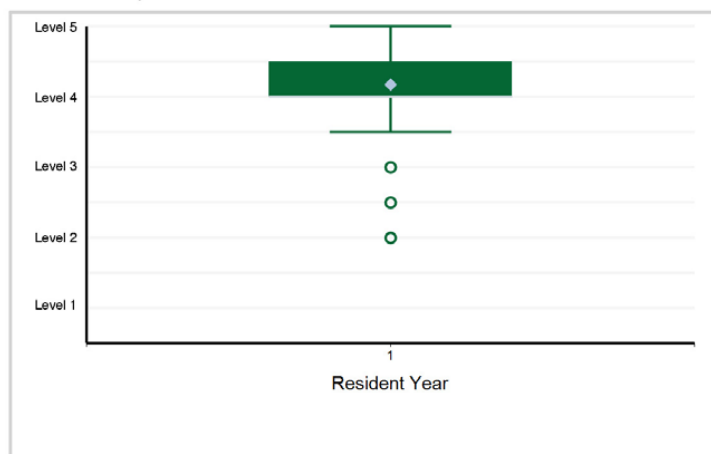

17. Professionalism - Professionalism 2: Accountability/Conscientiousness

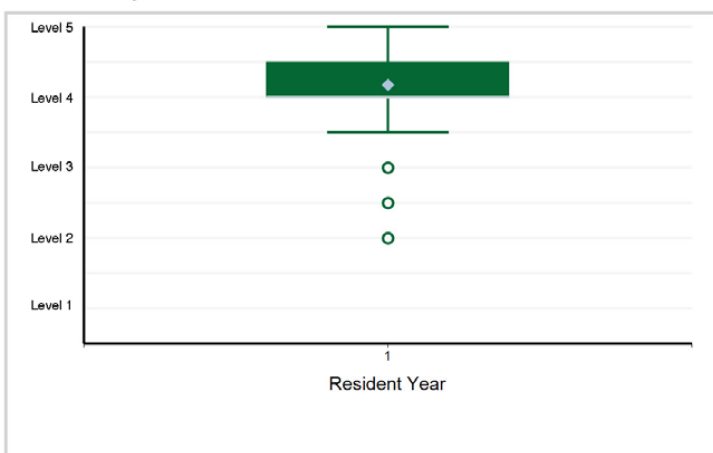

18. Professionalism - Professionalism 3: Self-Awareness and Help-Seeking

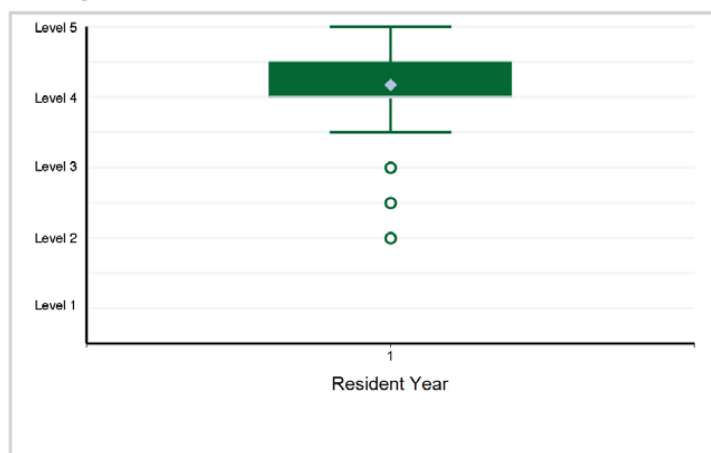

Specialty Box Plot Report - Milestone Evaluation by Resident Year: Year-End 2021-2022

SUBSPECIALTY: **Neuroradiology**

19. Interpersonal and Communication Skills - Interpersonal and Communication Skills 1: Patient- and Family-Centered Communication

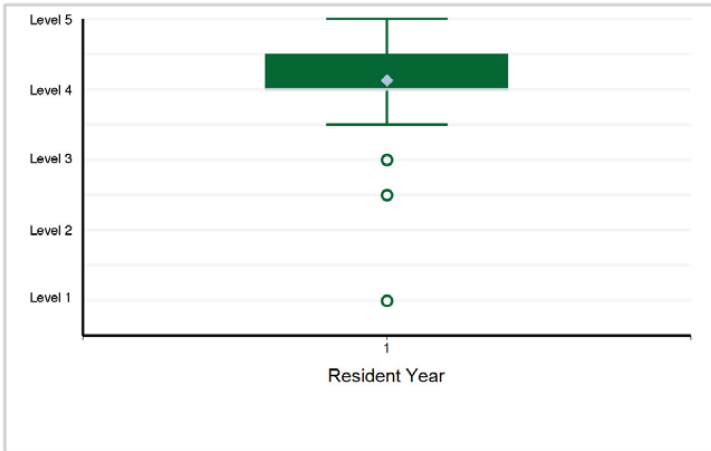

20. Interpersonal and Communication Skills - Interpersonal and Communication Skills 2: Interprofessional and Team Communication

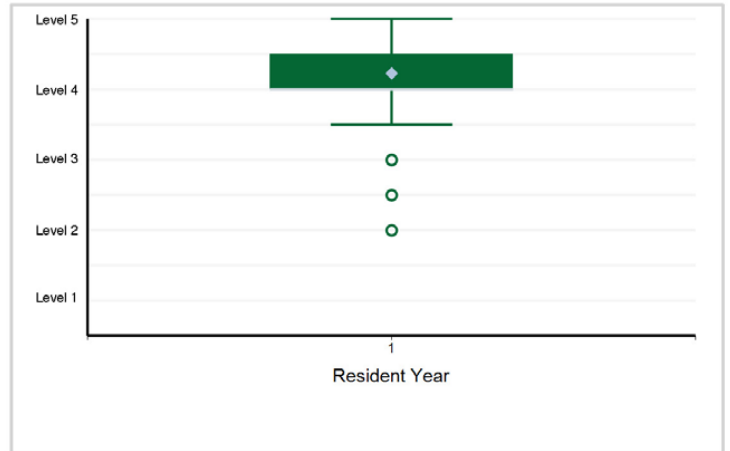

21. Interpersonal and Communication Skills - Interpersonal and Communication Skills 3: Communication within Health Care Systems

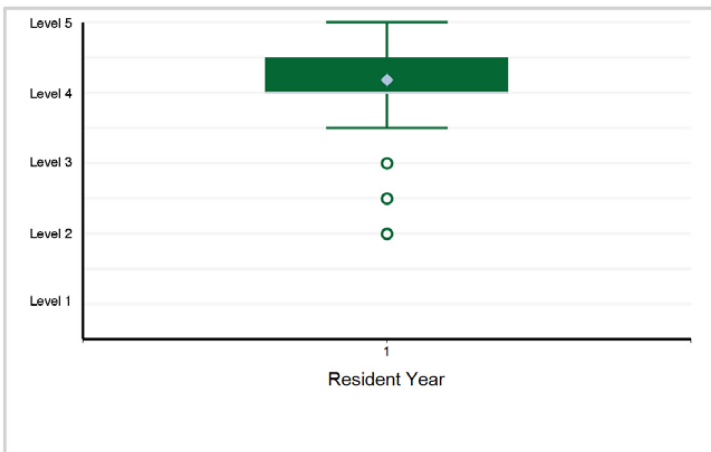

Specialty Box Plot Report - Milestone Evaluation by Resident Year: Year-End 2021-2022

TABLE 135: SUBSPECIALTY: **Nuclear Radiology**

Resident Year	1	Total Residents
# of Residents	14	14

1. Patient Care - Patient Care 1: Diagnostic Non-Cardiac Examinations

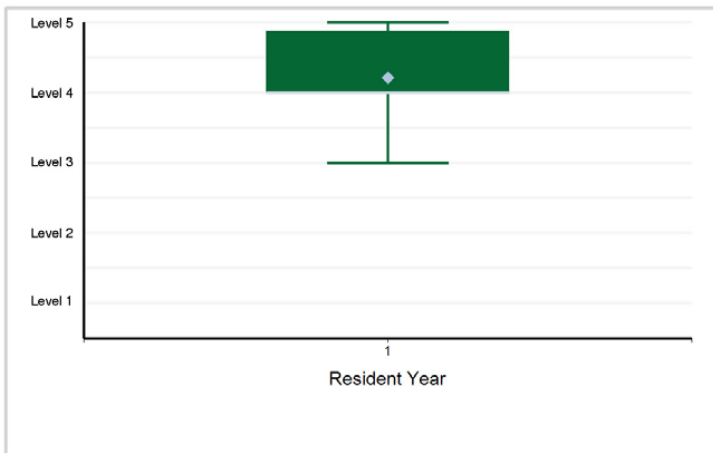

2. Patient Care - Patient Care 2: Diagnostic Cardiac Examinations

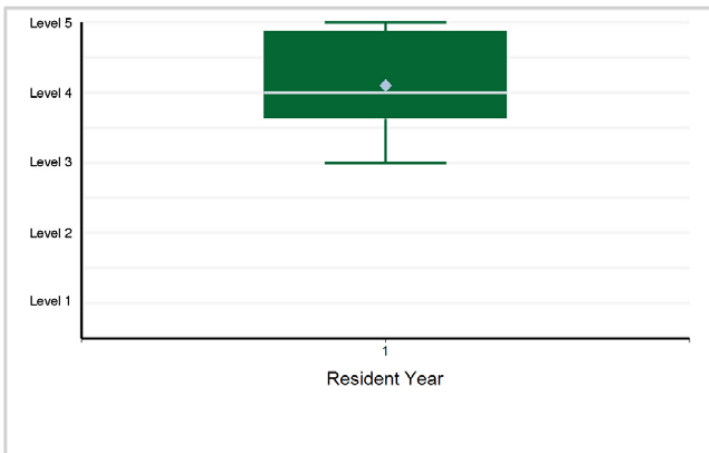

3. Patient Care - Patient Care 3: Radiopharmaceutical Therapies: Oral 131-I Nal and Parenteral

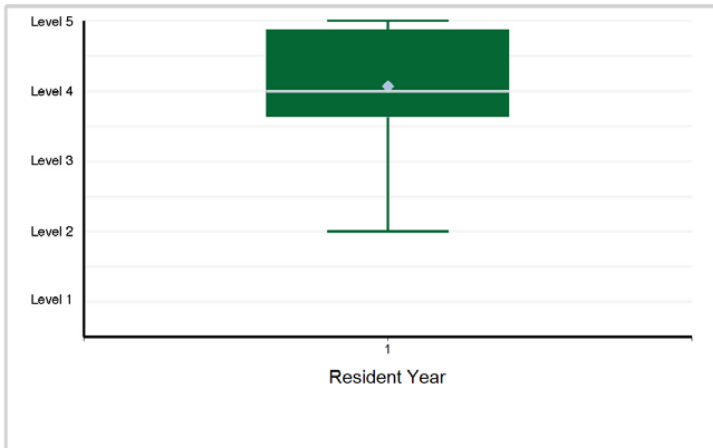

4. Medical Knowledge - Medical Knowledge 1: Physics and Instrumentation

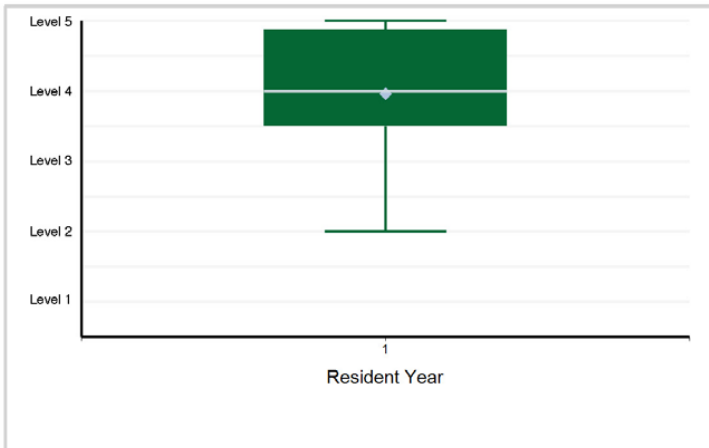

5. Medical Knowledge - Medical Knowledge 2: Radiopharmaceuticals and Pharmaceuticals

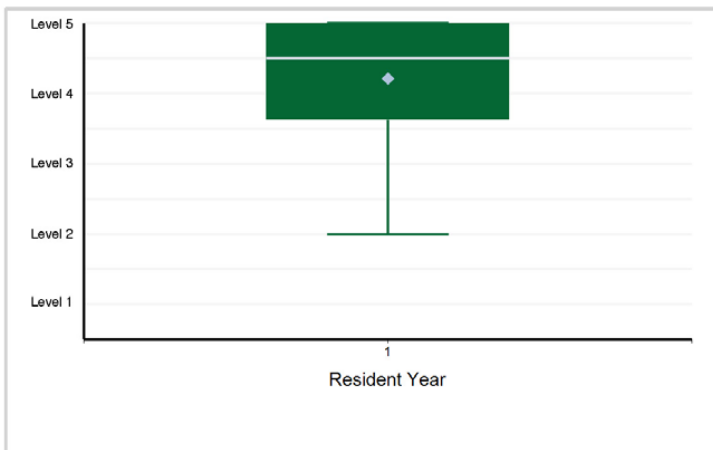

6. Medical Knowledge - Medical Knowledge 3: Molecular Imaging and Radiotherapeutics

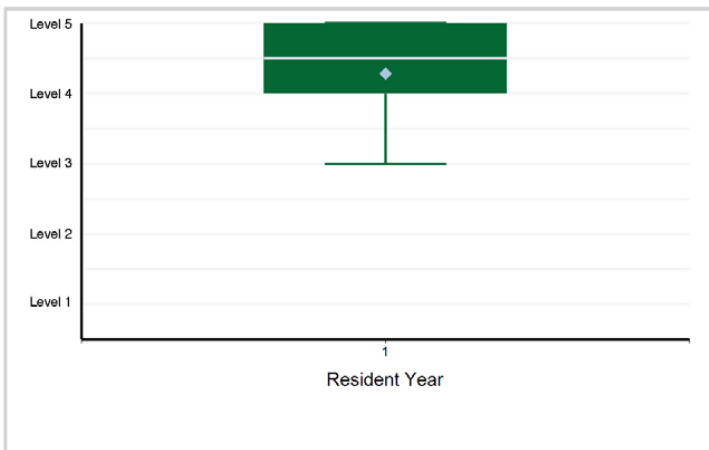

Specialty Box Plot Report - Milestone Evaluation by Resident Year: Year-End 2021-2022

SUBSPECIALTY: Nuclear Radiology

7. Systems-Based Practice - Systems-Based Practice 1: Patient Safety

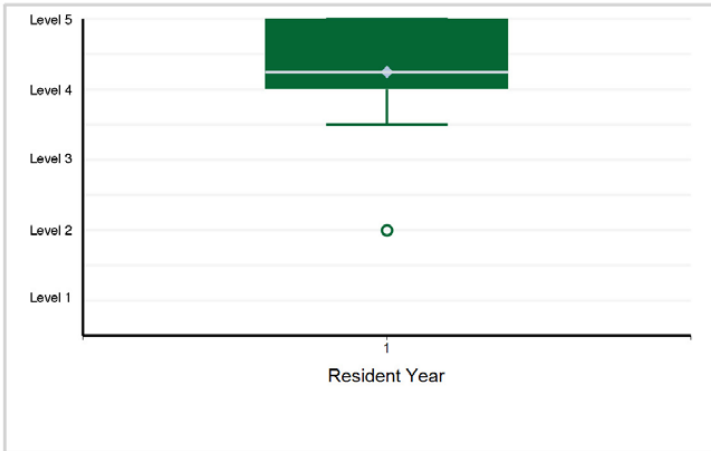

8. Systems-Based Practice - Systems-Based Practice 2: Quality Improvement

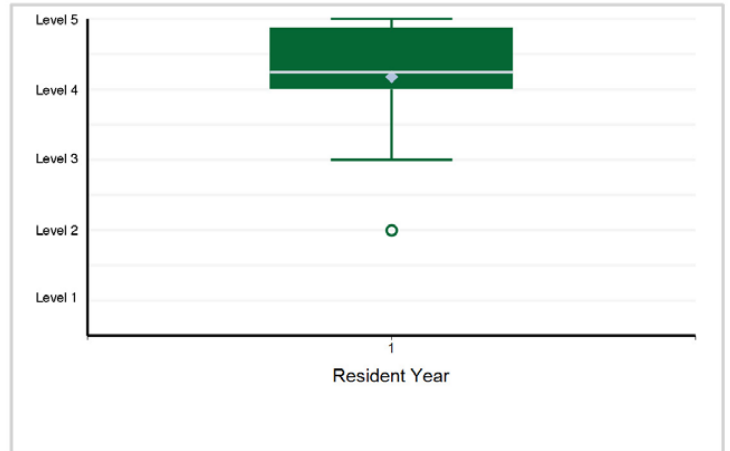

9. Systems-Based Practice - Systems-Based Practice 3: System Navigation for Patient-Centered Care

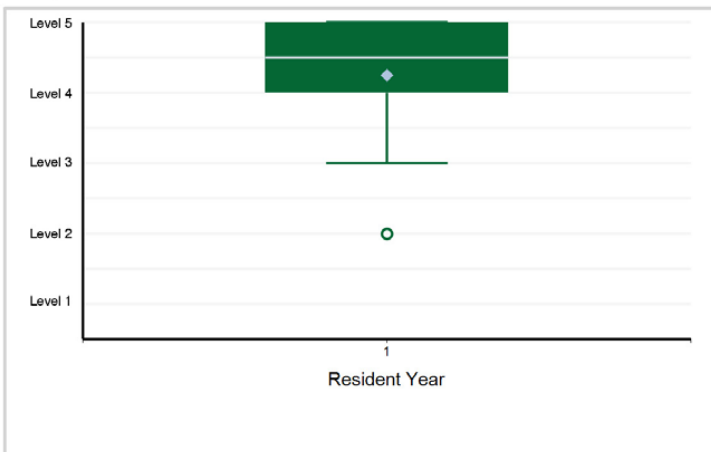

10. Systems-Based Practice - Systems-Based Practice 4: Physician Role in Health Care Systems



11. Systems-Based Practice - Systems-Based Practice 5: Radiation Safety

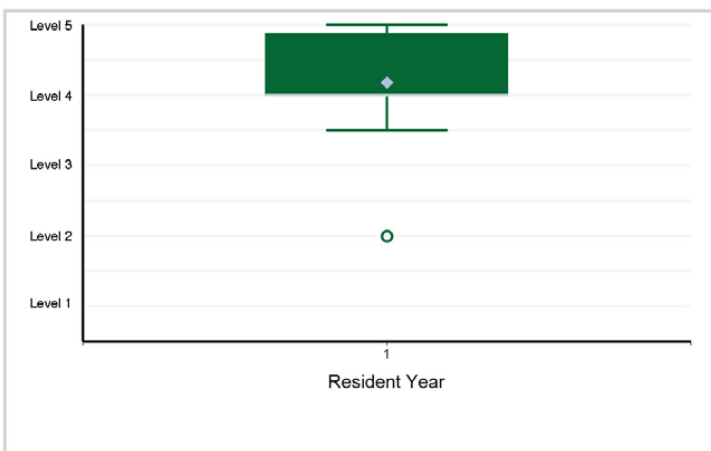

12. Systems-Based Practice - Systems-Based Practice 6: Regulatory Requirements



Specialty Box Plot Report - Milestone Evaluation by Resident Year: Year-End 2021-2022

SUBSPECIALTY: Nuclear Radiology

13. Practice-Based Learning and Improvement - Practice-Based Learning and Improvement 1: Evidence-Based and Informed Practice

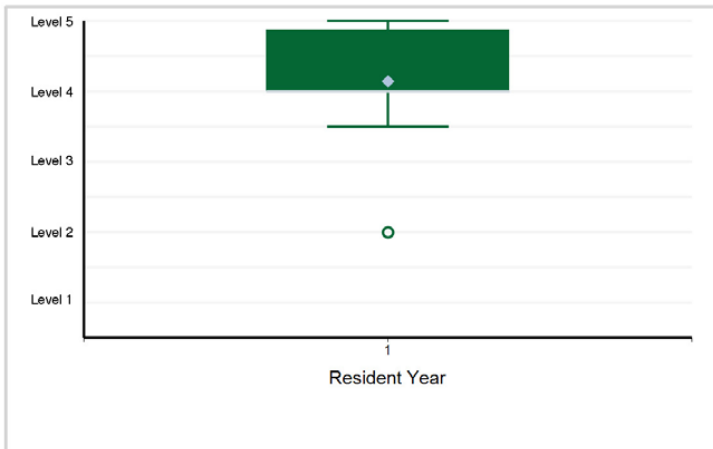

14. Practice-Based Learning and Improvement - Practice-Based Learning and Improvement 2: Reflective Practice and Commitment ...

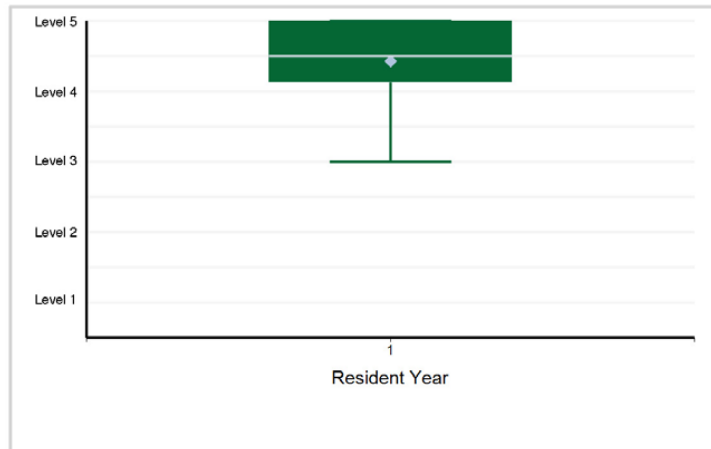

15. Professionalism - Professionalism 1: Professional Behavior and Ethical Principles

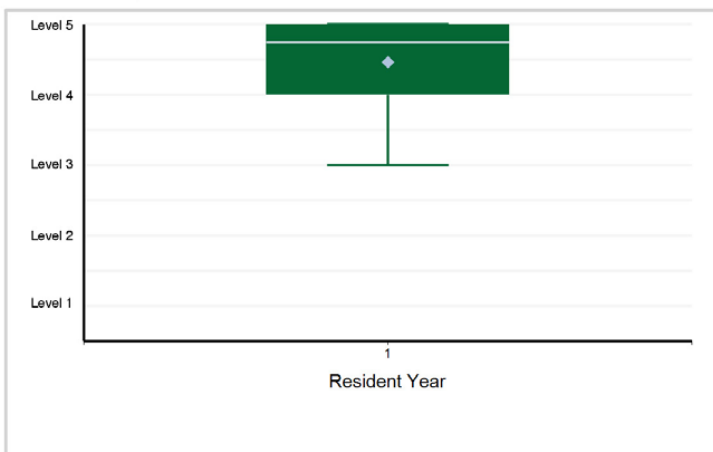

16. Professionalism - Professionalism 2: Accountability/Conscientiousness

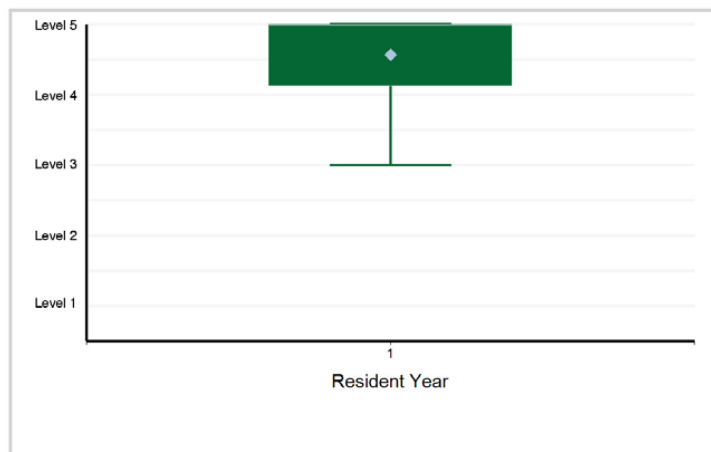

17. Professionalism - Professionalism 3: Self-Awareness and Help-Seeking

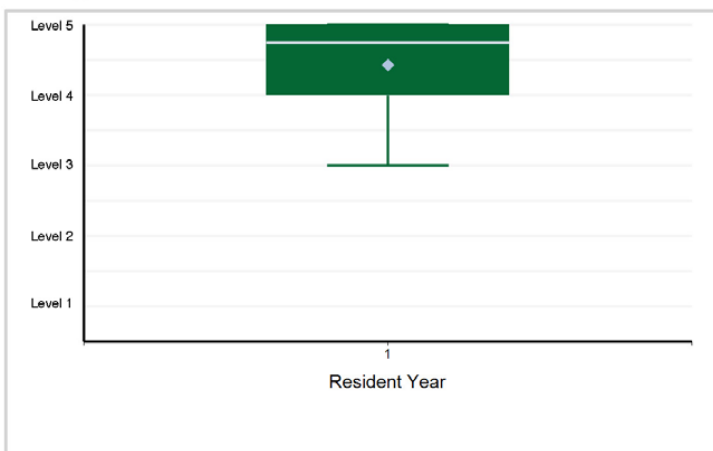

18. Interpersonal and Communication Skills - Interpersonal and Communication Skills 1: Patient- and Family-Centered Communication

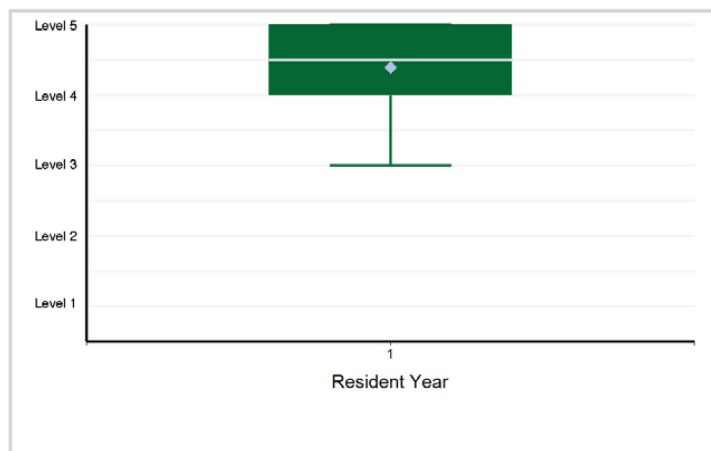

Specialty Box Plot Report - Milestone Evaluation by Resident Year: Year-End 2021-2022

SUBSPECIALTY: Nuclear Radiology

19. Interpersonal and Communication Skills - Interpersonal and Communication Skills 2: Interprofessional and Team Communication

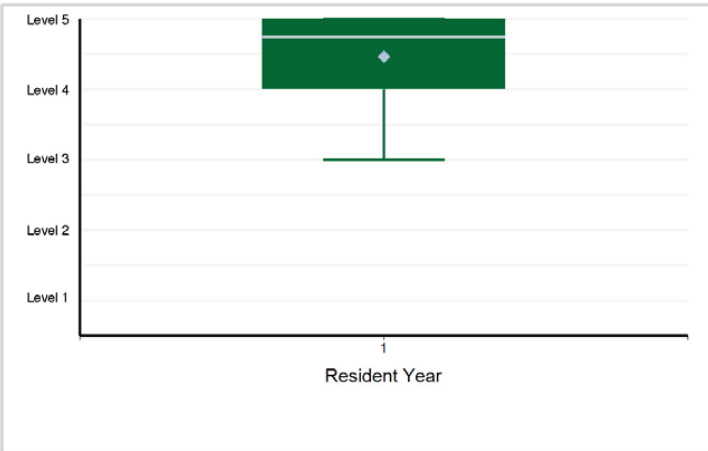

20. Interpersonal and Communication Skills - Interpersonal and Communication Skills 3: Communication within Health Care Systems

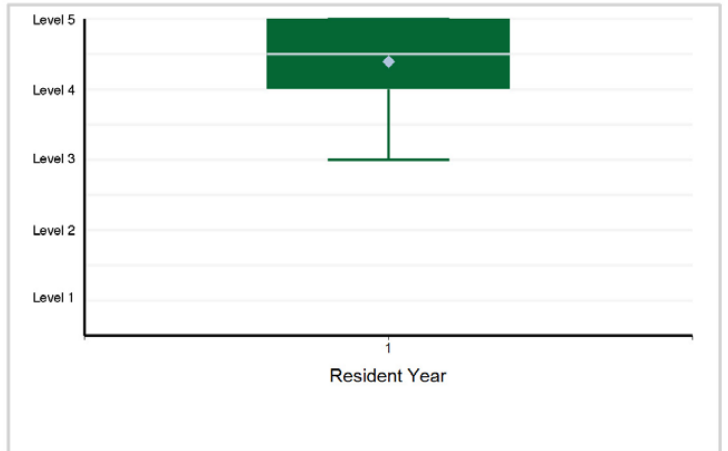

Specialty Box Plot Report - Milestone Evaluation by Resident Year: Year-End 2021-2022

TABLE 136: SUBSPECIALTY: **Pediatric Radiology**

Resident Year	1	Total Residents*
# of Residents	53	53

*Note: There are 1 residents with an incomplete milestone evaluation that are excluded from the box plots below.

1. Patient Care - Consultant — Patient Care 1



2. Patient Care - Safety — Patient Care 2

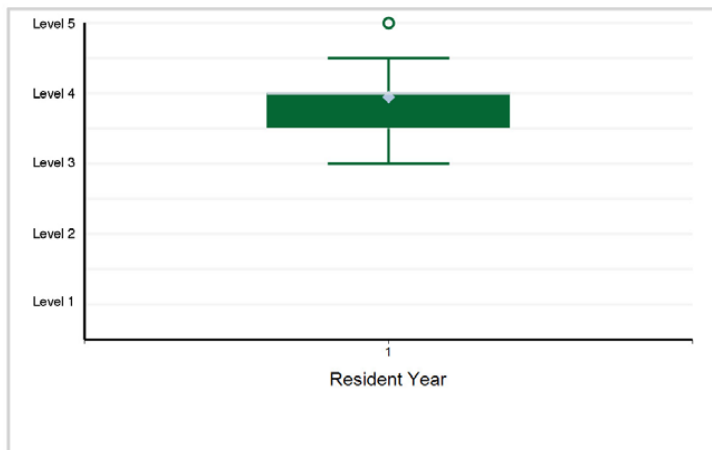

3. Patient Care - Competence in Procedures — Patient Care 3



4. Medical Knowledge - Protocol Selection and Optimization of Images — Medical Knowledge 1

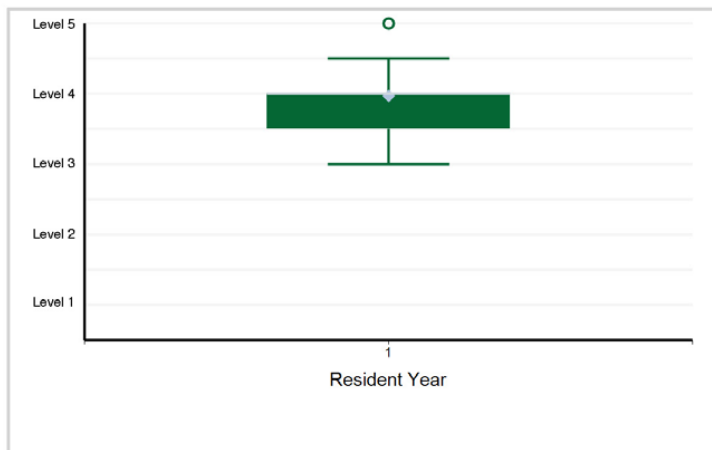

5. Medical Knowledge - Interpretation — Medical Knowledge 2

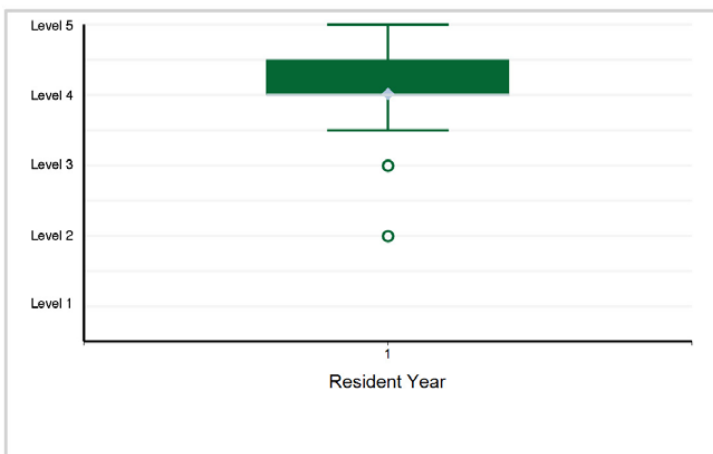

6. Medical Knowledge - Knowledge of Basic and Clinical Science Appropriate to Pediatric Radiology — Medical Knowledge 3

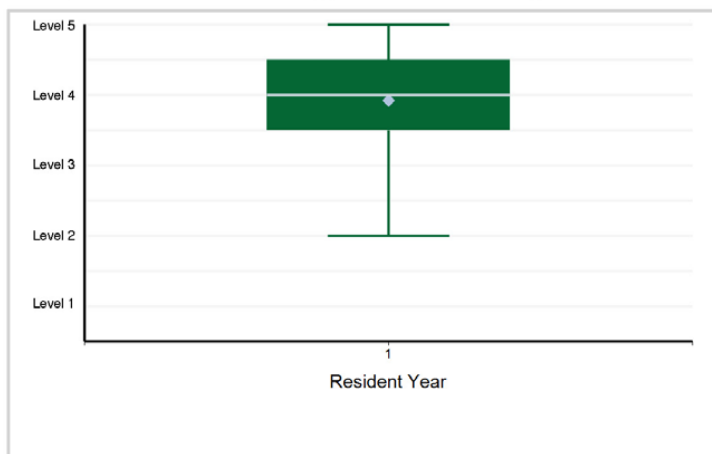

Specialty Box Plot Report - Milestone Evaluation by Resident Year: Year-End 2021-2022

SUBSPECIALTY: Pediatric Radiology

7. Systems-Based Practice - Quality Improvement — Systems-Based Practice 1

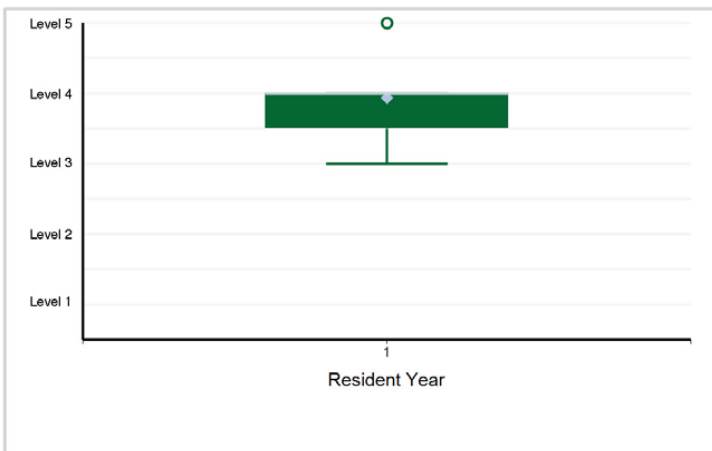

8. Systems-Based Practice - Health Care Economics — Systems-Based Practice 2

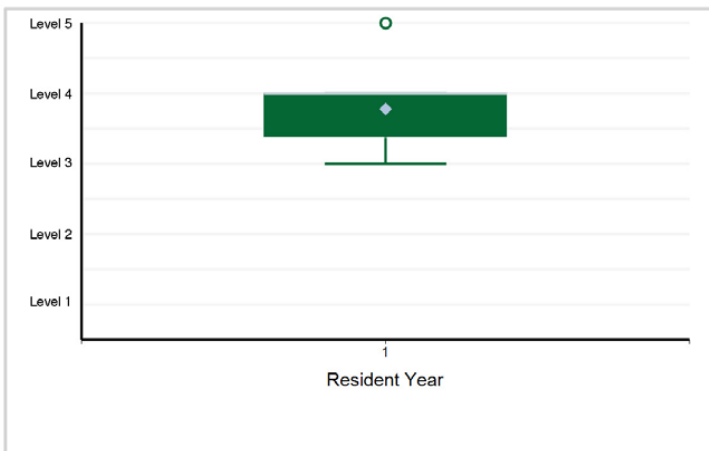

9. Practice-Based Learning and Improvement - Self-directed learning — Practice-Based Learning and Improvement 1

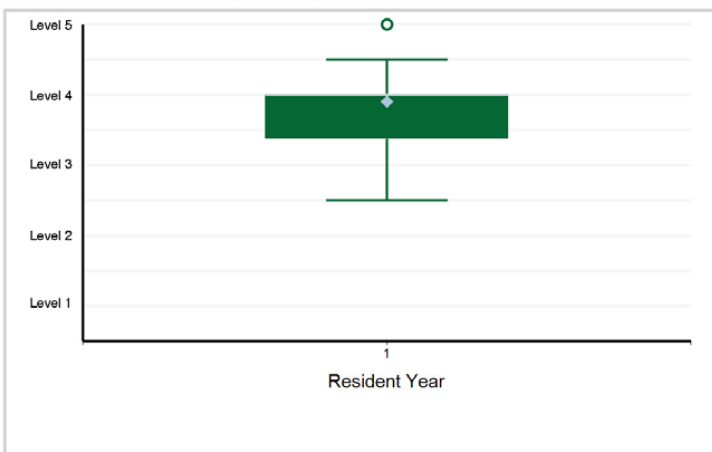

10. Practice-Based Learning and Improvement - Scholarly Activity — Practice-Based Learning and Improvement 2

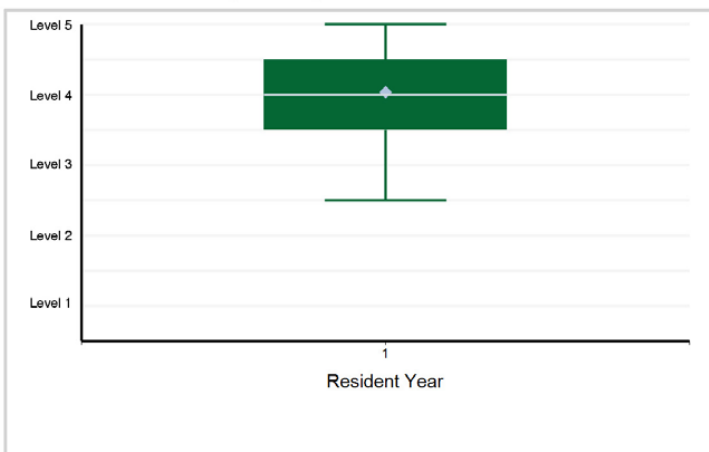

11. Professionalism - Personal — Professionalism 1

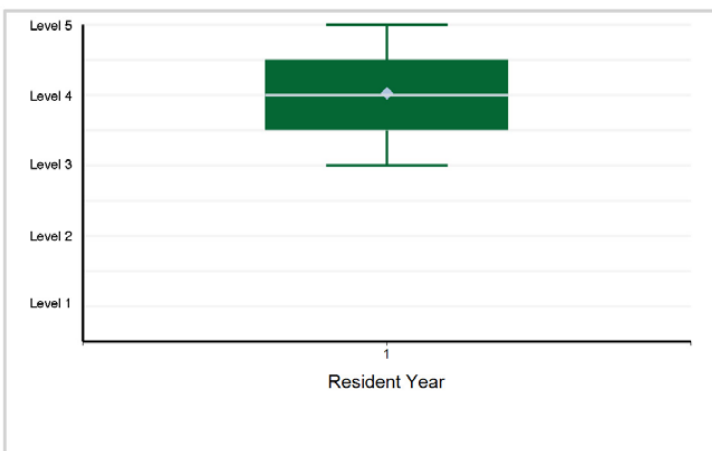

12. Interpersonal and Communication Skills - Effective Communication with Patients, Families, and Caregivers ...

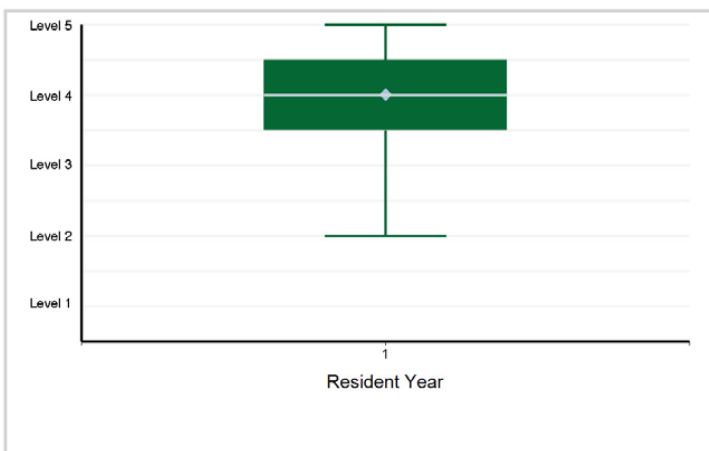

Specialty Box Plot Report - Milestone Evaluation by Resident Year: Year-End 2021-2022

SUBSPECIALTY: Pediatric Radiology

13. Interpersonal and Communication Skills - Effective Communication with Members of the Health Care Team ...

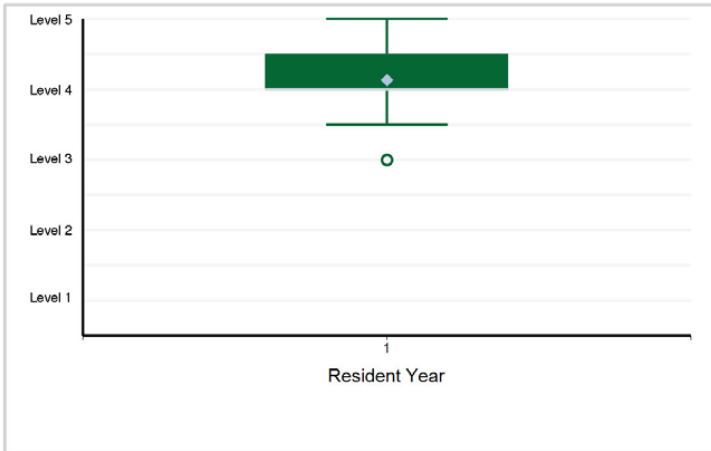

14. Interpersonal and Communication Skills - Effective Teaching — Interpersonal and Communication Skills 3

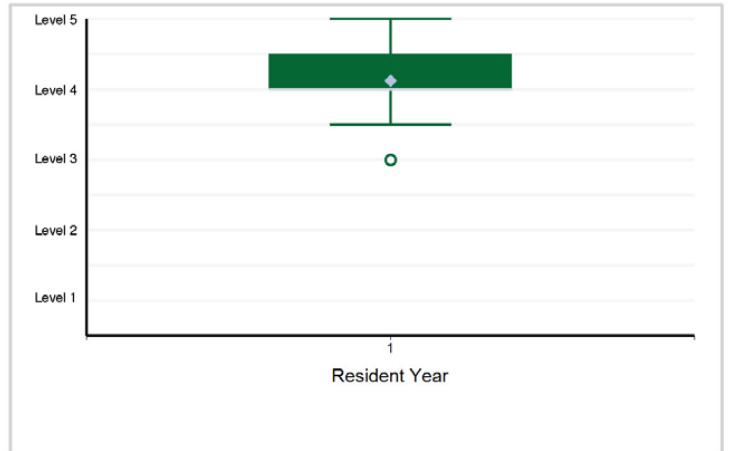

Specialty Box Plot Report - Milestone Evaluation by Resident Year: Year-End 2021-2022

TABLE 137: SPECIALTY: **Interventional Radiology - Independent**

Resident Year	1	2	Total Residents
# of Residents	127	80	207

1. Patient Care - Patient Care 1: Reporting

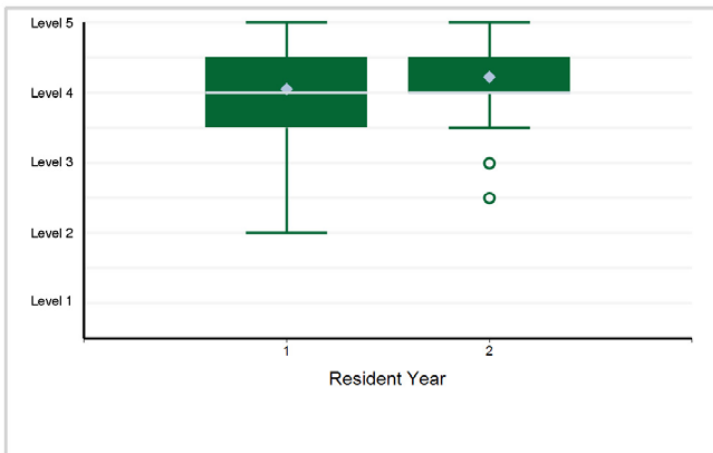

2. Patient Care - Patient Care 2: Imaging Consultation

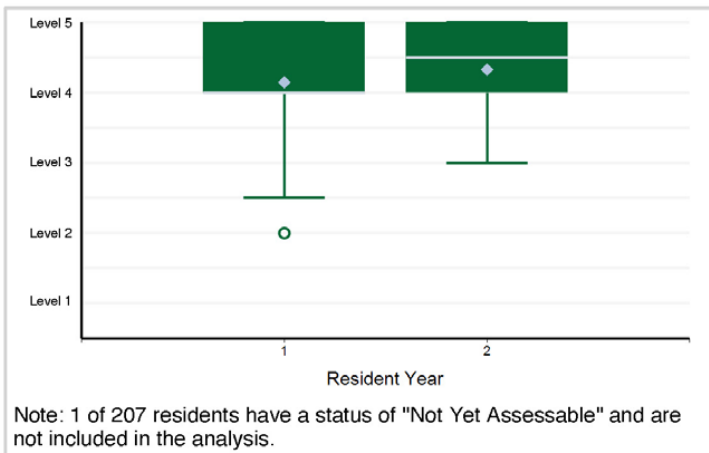

3. Patient Care - Patient Care 3: Pre-Procedural Consultation

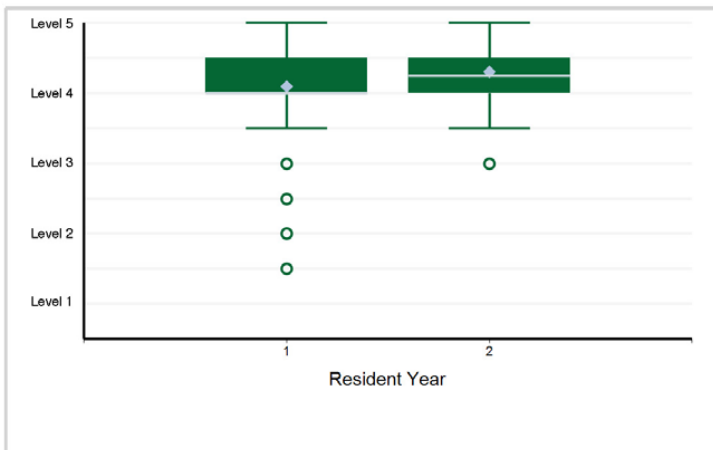

4. Patient Care - Patient Care 4: Performance of Procedures

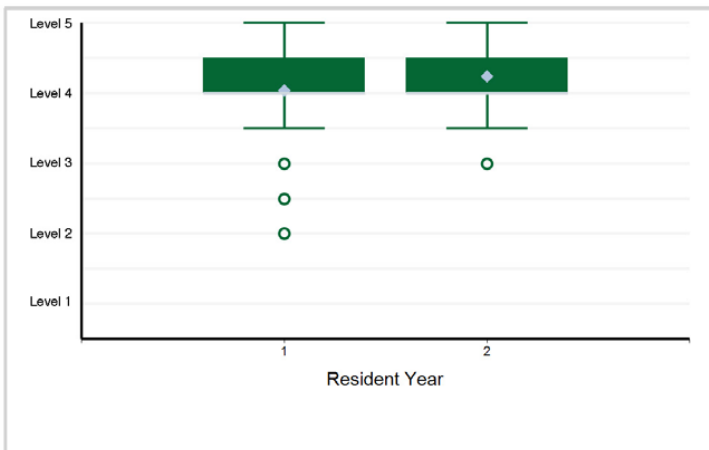

5. Patient Care - Patient Care 5: Post-Procedural Patient Care

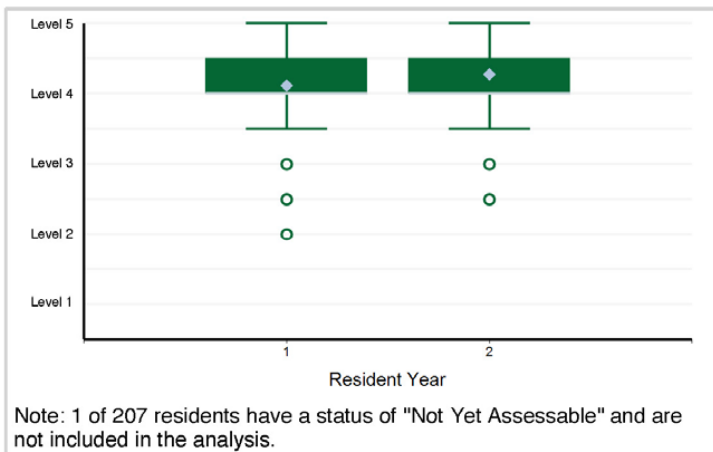

6. Medical Knowledge - Medical Knowledge 1: Pathophysiology and Treatment

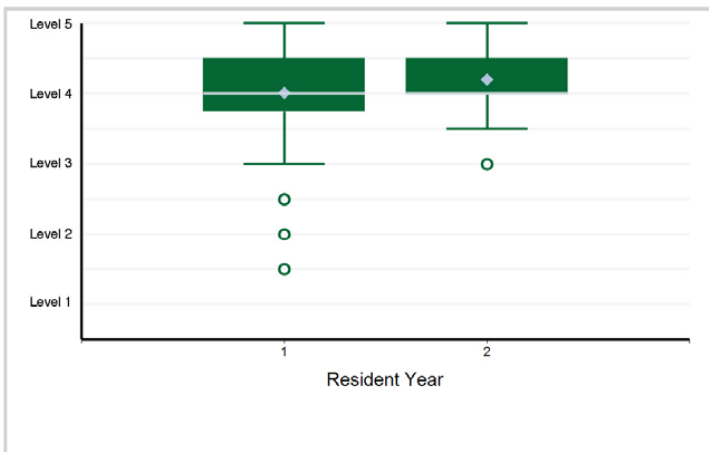

Specialty Box Plot Report - Milestone Evaluation by Resident Year: Year-End 2021-2022

SPECIALTY: Interventional Radiology - Independent

7. Medical Knowledge - Medical Knowledge 2: Procedural Anatomy

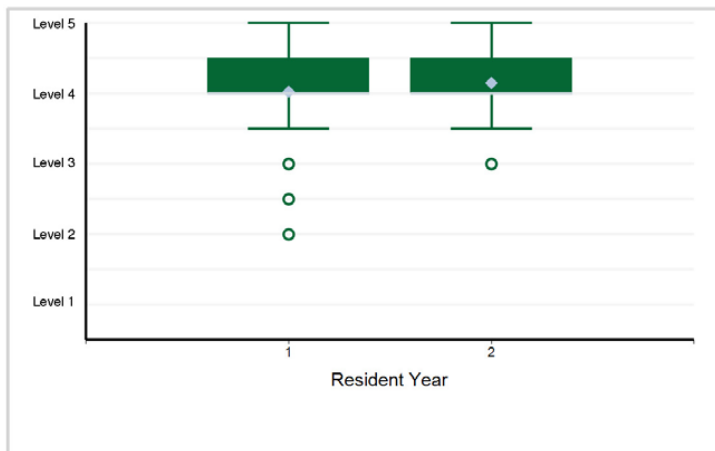

8. Medical Knowledge - Medical Knowledge 3: Pharmacology

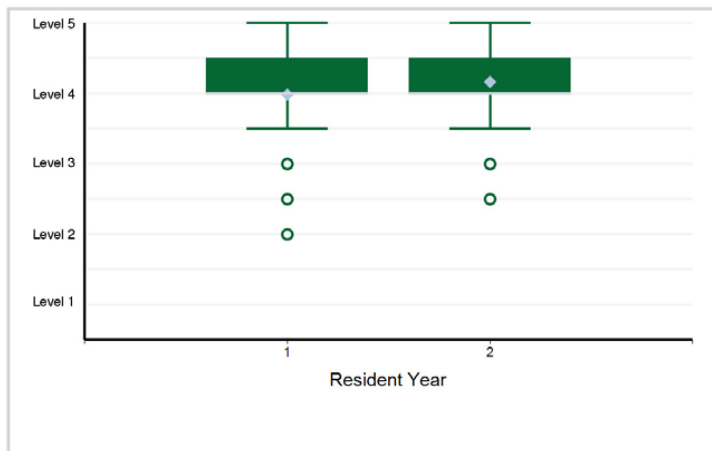

9. Systems-Based Practice - Systems-Based Practice 1: Patient Safety

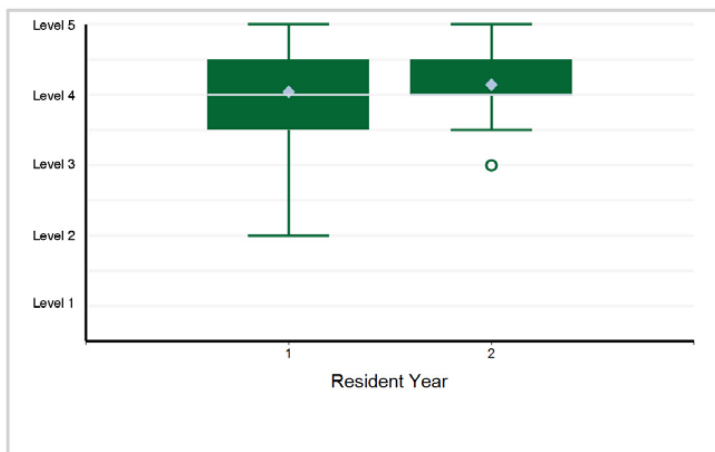

10. Systems-Based Practice - Systems-Based Practice 2: Quality Improvement

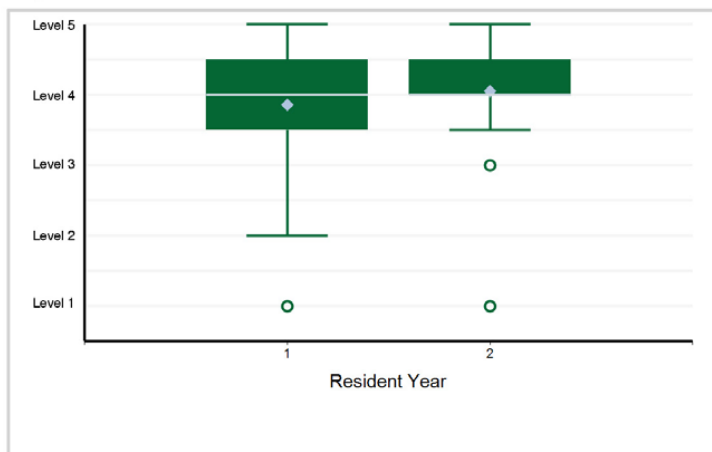

11. Systems-Based Practice - Systems-Based Practice 3: System Navigation for Patient-Centered Care

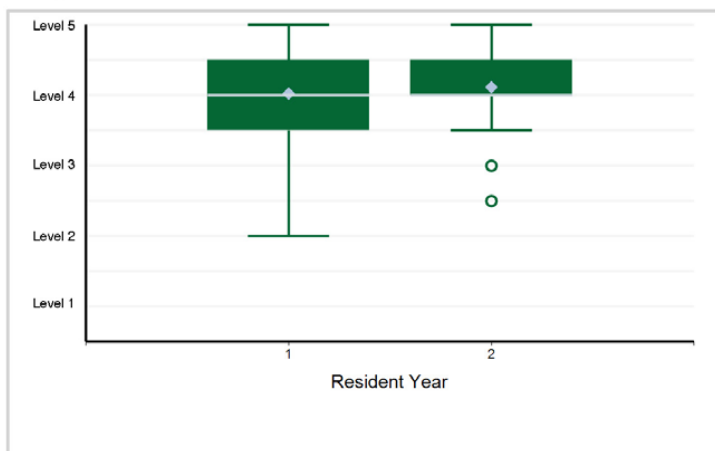

12. Systems-Based Practice - Systems-Based Practice 4: Multidisciplinary Conferences

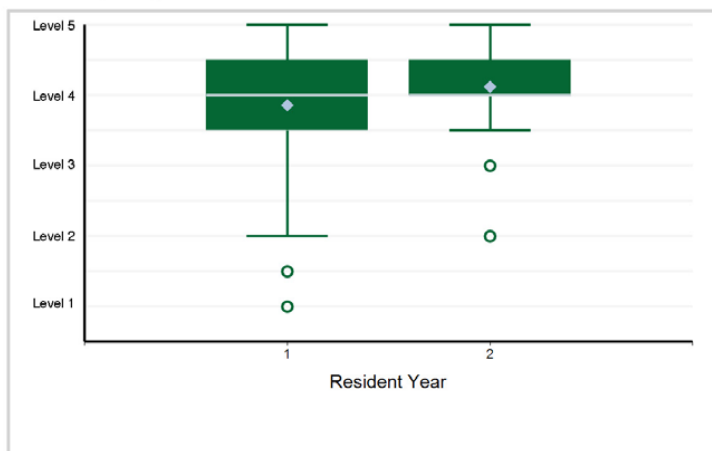

Specialty Box Plot Report - Milestone Evaluation by Resident Year: Year-End 2021-2022

SPECIALTY: **Interventional Radiology - Independent**

13. Systems-Based Practice - Systems-Based Practice 5: Population Health

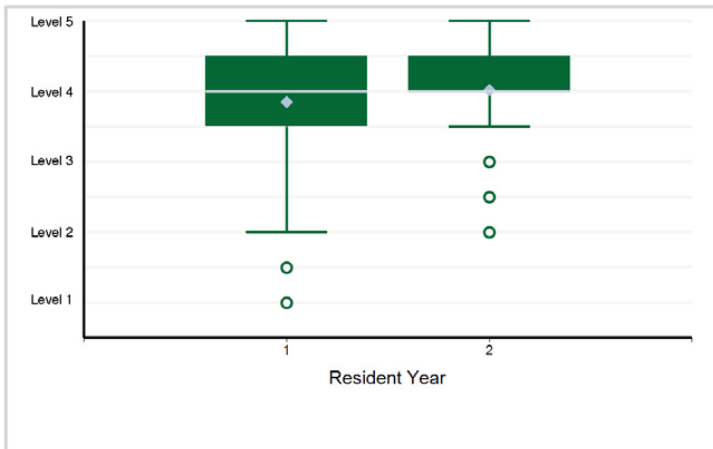

14. Systems-Based Practice - Systems-Based Practice 6: Physician Role in Health Care Systems

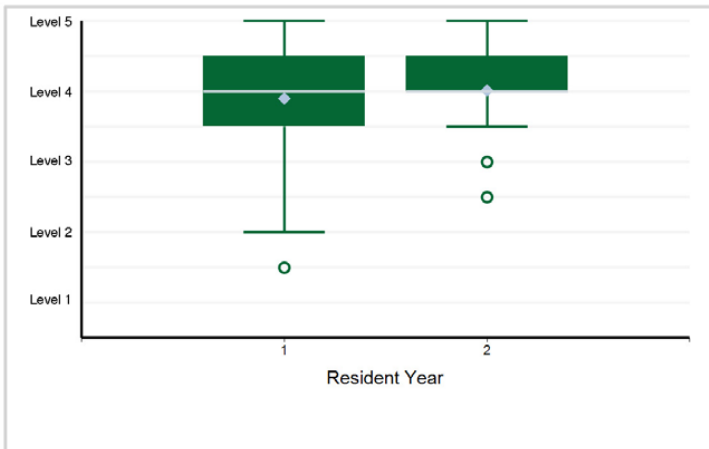

15. Systems-Based Practice - Systems-Based Practice 7: Radiation Safety

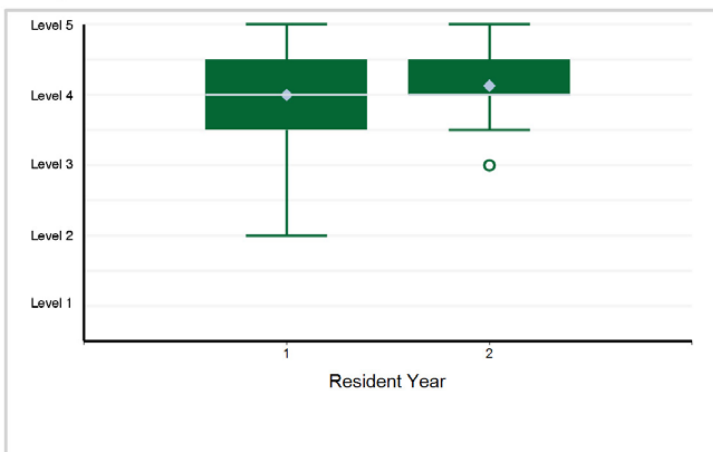

16. Practice-Based Learning and Improvement - Practice-Based Learning and Improvement 1: Evidence-Based and Informed Practice

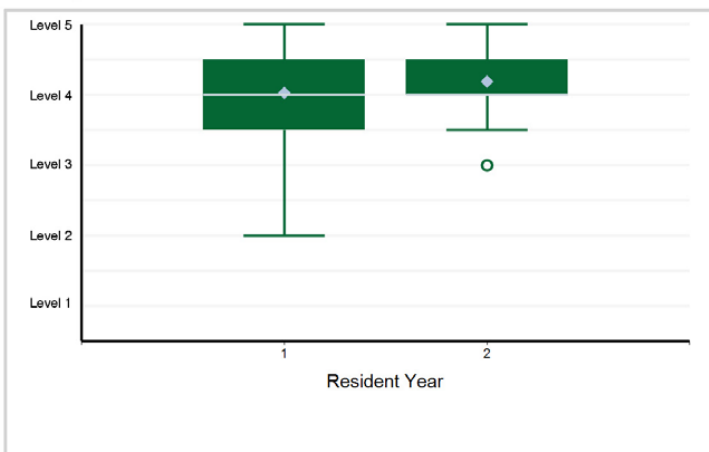

17. Practice-Based Learning and Improvement - Practice-Based Learning and Improvement 2: Reflective Practice and Commitment ...

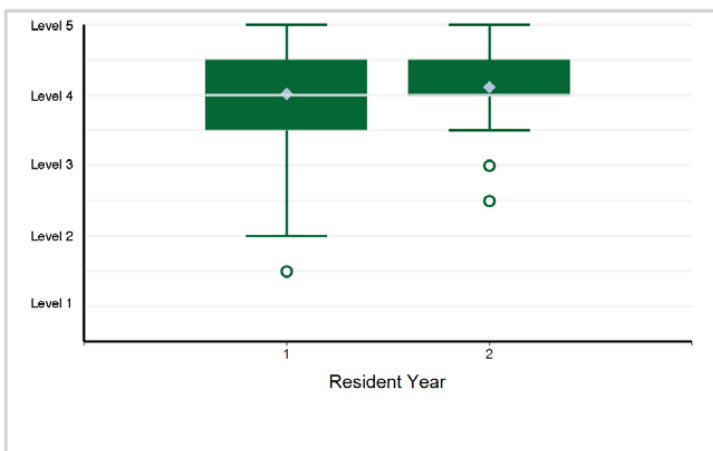

18. Professionalism - Professionalism 1: Professional Behavior

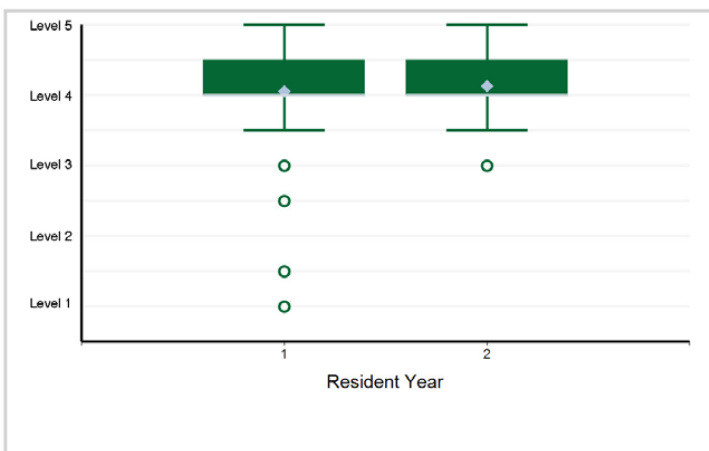

Specialty Box Plot Report - Milestone Evaluation by Resident Year: Year-End 2021-2022

SPECIALTY: Interventional Radiology - Independent

19. Professionalism - Professionalism 2: Ethical Principles

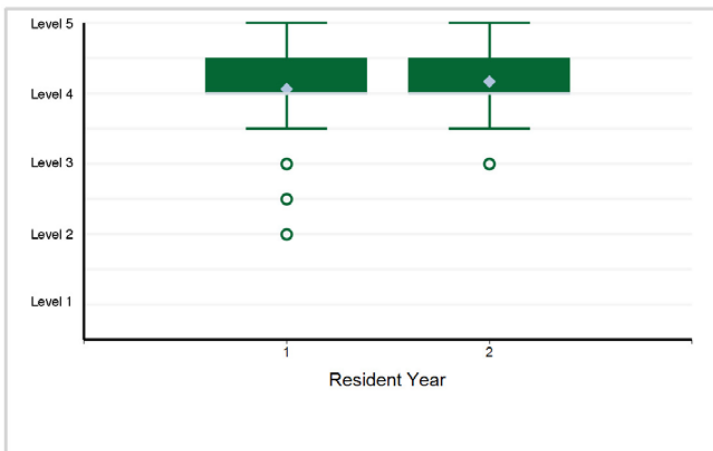

20. Professionalism - Professionalism 3: Accountability/Conscientiousness

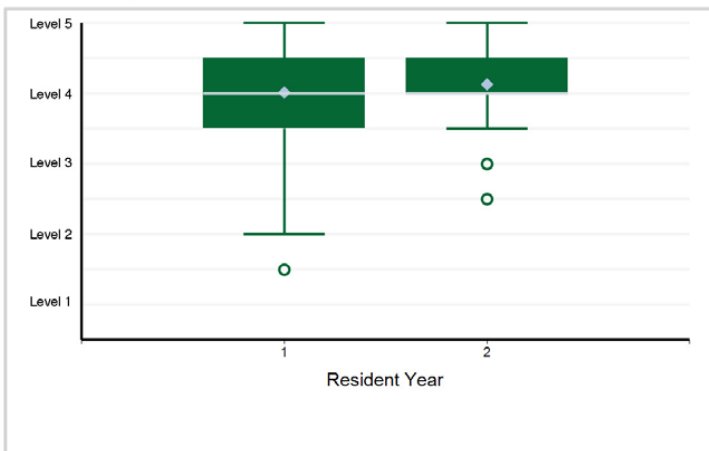

21. Professionalism - Professionalism 4: Self-Awareness and Help-Seeking

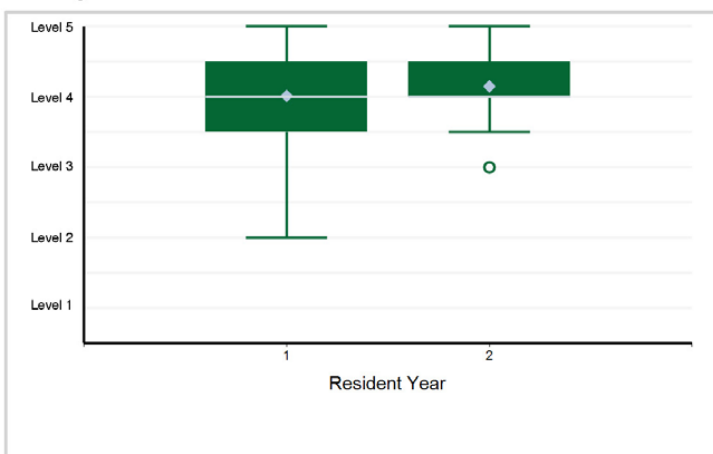

22. Interpersonal and Communication Skills - Interpersonal and Communication Skills 1: Patient- and Family-Centered Communication

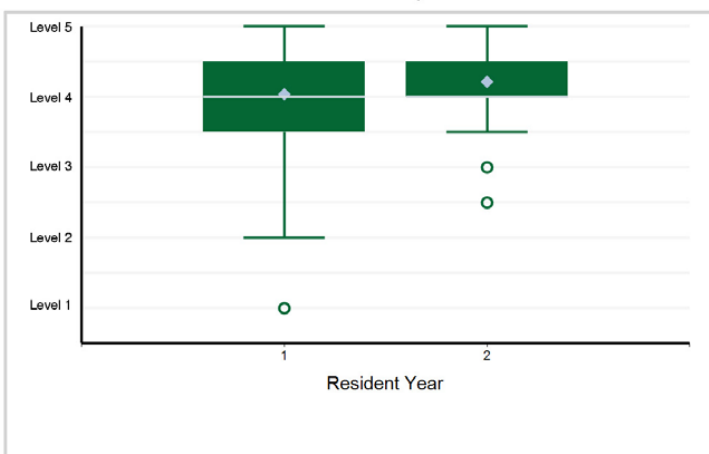

23. Interpersonal and Communication Skills - Interpersonal and Communication Skills 2: Interprofessional and Team Communication

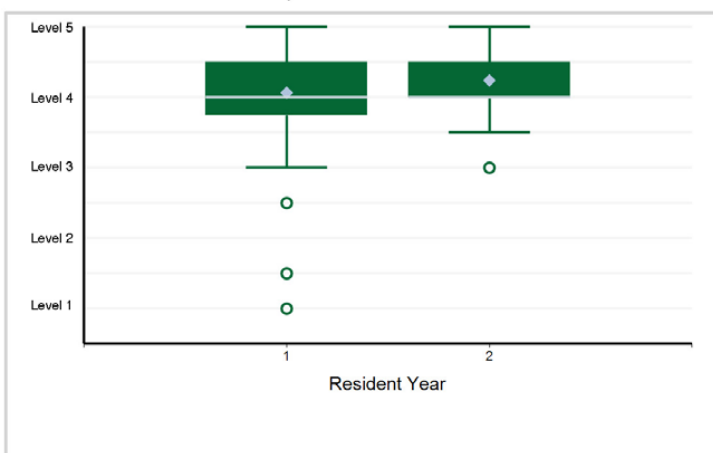

24. Interpersonal and Communication Skills - Interpersonal and Communication Skills 3: Communication within Health Care Systems

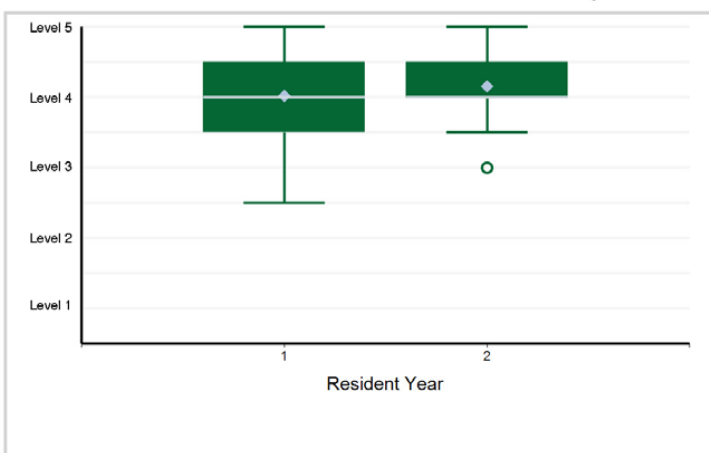

Specialty Box Plot Report - Milestone Evaluation by Resident Year: Year-End 2021-2022

TABLE 138: SPECIALTY: **Interventional Radiology - Integrated**

Resident Year	1	2	3	4	5	Total Residents
# of Residents	148	153	132	133	84	650

1. Patient Care - Patient Care 1: Reporting

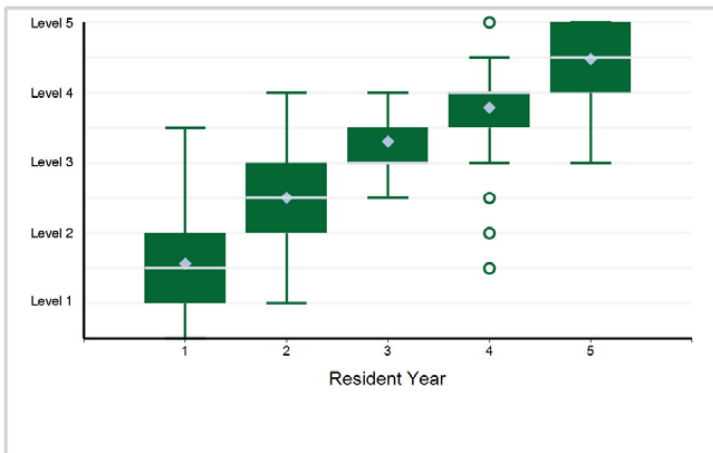

2. Patient Care - Patient Care 2: Imaging Consultation

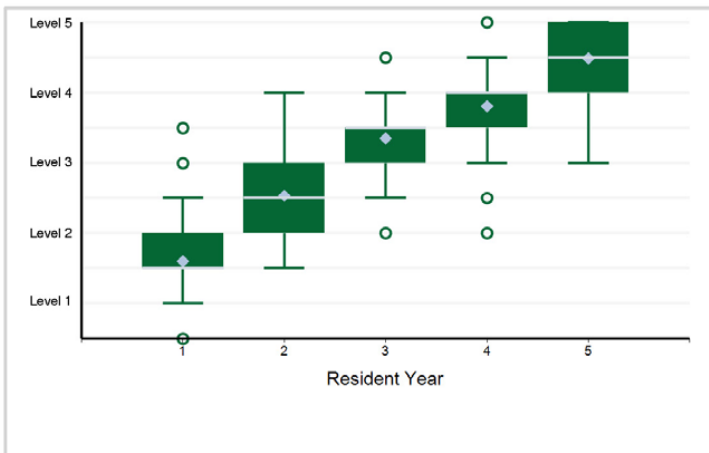

3. Patient Care - Patient Care 3: Image Interpretation

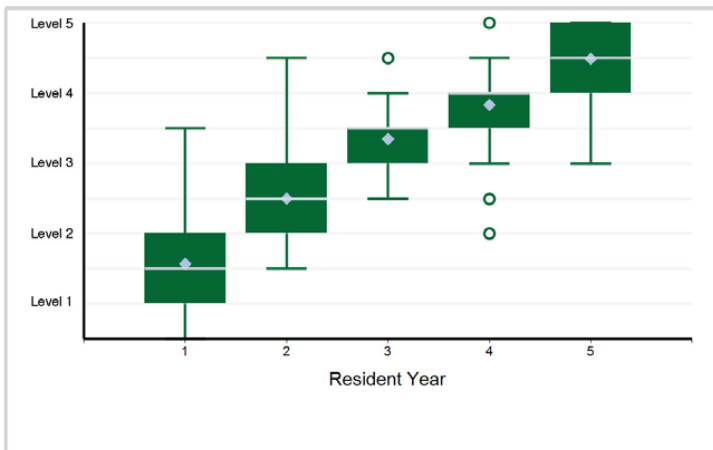

4. Patient Care - Patient Care 4: Pre-Procedural Consultation

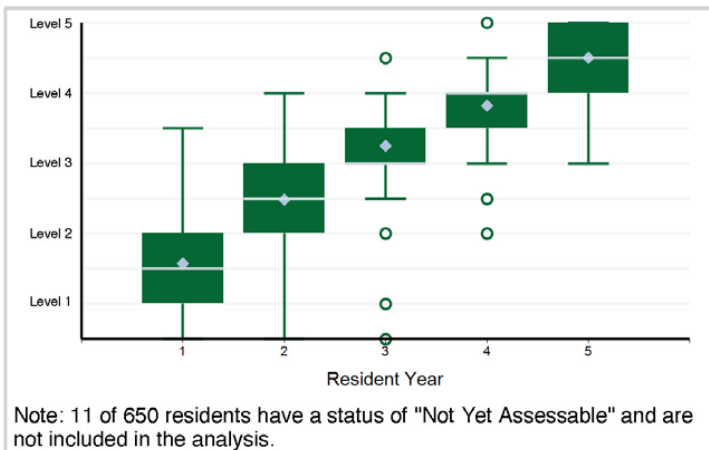

Note: 11 of 650 residents have a status of "Not Yet Assessable" and are not included in the analysis.

5. Patient Care - Patient Care 5: Performance of Procedures

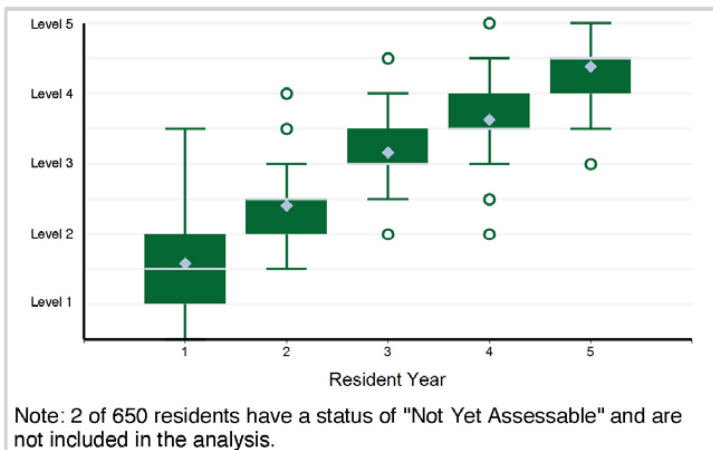

Note: 2 of 650 residents have a status of "Not Yet Assessable" and are not included in the analysis.

6. Patient Care - Patient Care 6: Post-Procedural Patient Care

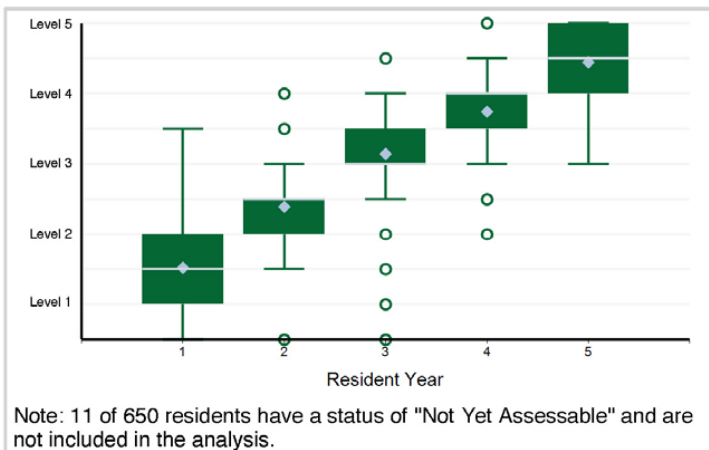

Note: 11 of 650 residents have a status of "Not Yet Assessable" and are not included in the analysis.

Specialty Box Plot Report - Milestone Evaluation by Resident Year: Year-End 2021-2022

SPECIALTY: Interventional Radiology - Integrated

7. Medical Knowledge - Medical Knowledge 1: Diagnostic Imaging Knowledge

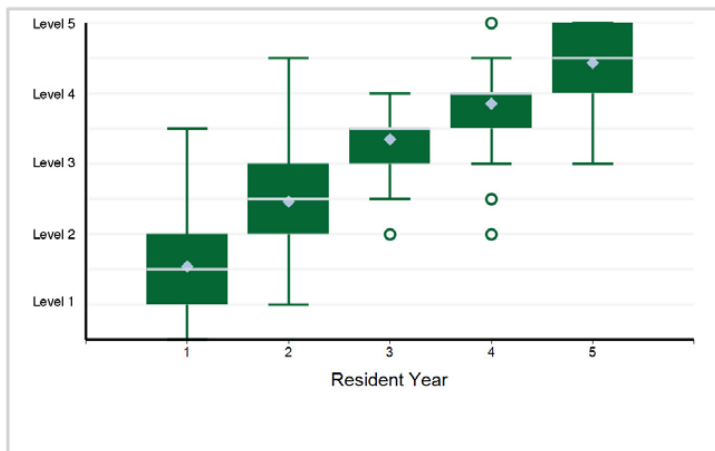

8. Medical Knowledge - Medical Knowledge 2: Physics, Protocol Selection, and Optimization of Images

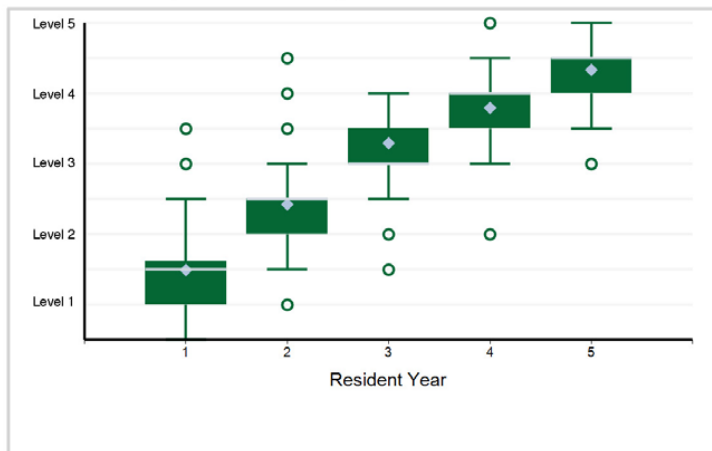

9. Medical Knowledge - Medical Knowledge 3: Imaging Technology and Image Acquisition

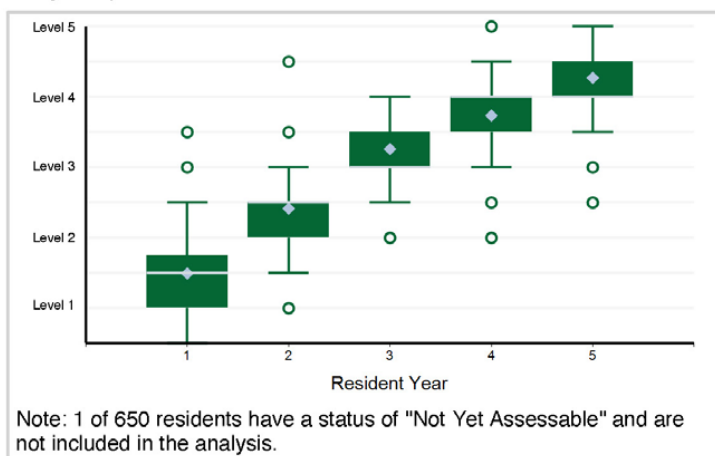

10. Medical Knowledge - Medical Knowledge 4: Pathophysiology and Treatment

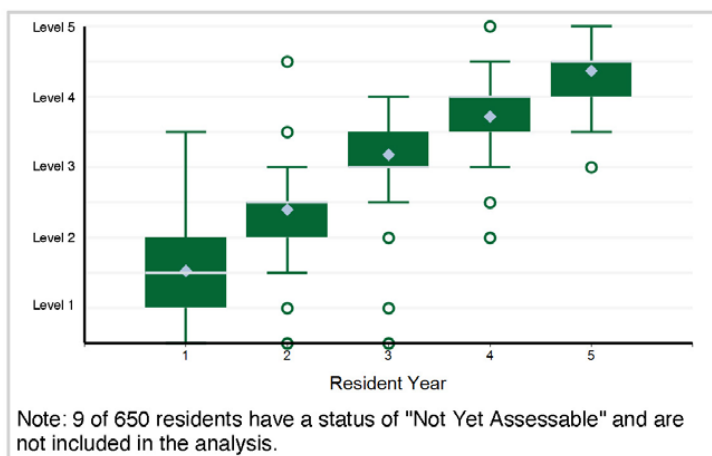

11. Medical Knowledge - Medical Knowledge 5: Procedural Anatomy

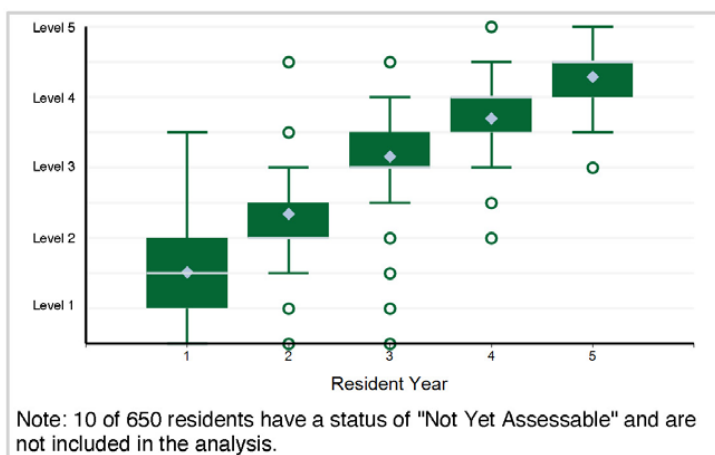

12. Medical Knowledge - Medical Knowledge 6: Pharmacology

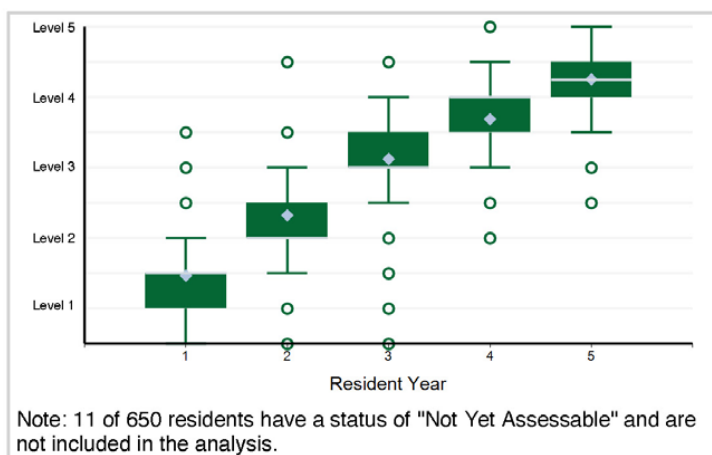

Specialty Box Plot Report - Milestone Evaluation by Resident Year: Year-End 2021-2022

SPECIALTY: Interventional Radiology - Integrated

13. Systems-Based Practice - Systems-Based Practice 1: Patient Safety

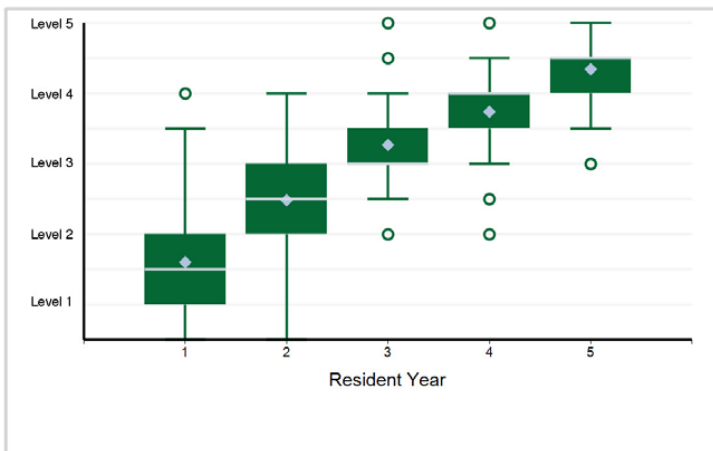

14. Systems-Based Practice - Systems-Based Practice 2: Quality Improvement

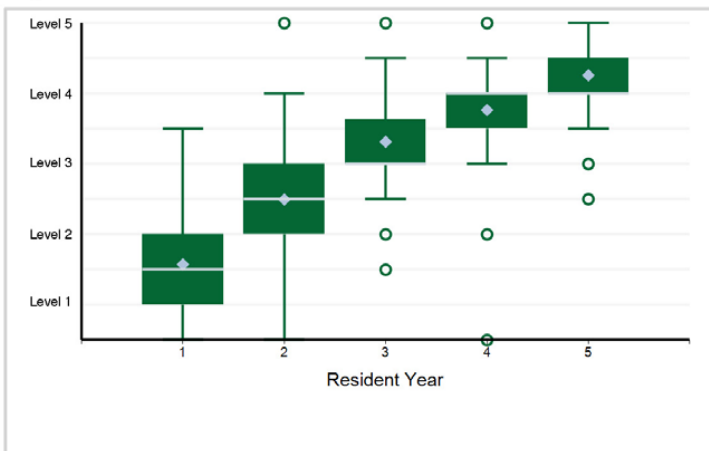

15. Systems-Based Practice - Systems-Based Practice 3: System Navigation for Patient-Centered Care

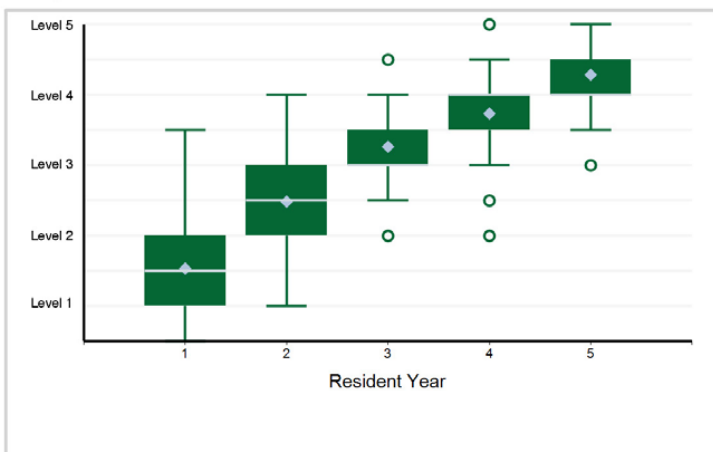

16. Systems-Based Practice - Systems-Based Practice 4: Multidisciplinary Conferences

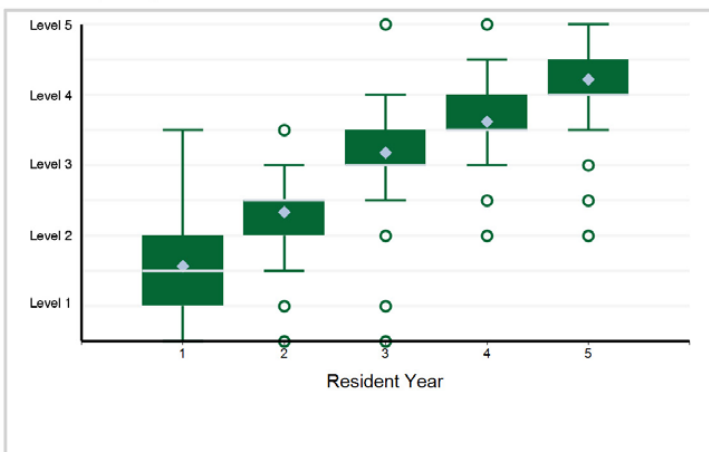

17. Systems-Based Practice - Systems-Based Practice 5: Population Health

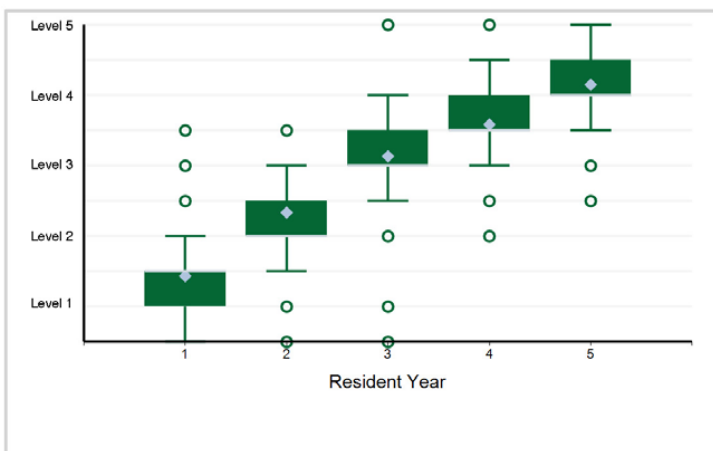

18. Systems-Based Practice - Systems-Based Practice 6: Physician Role in Health Care Systems

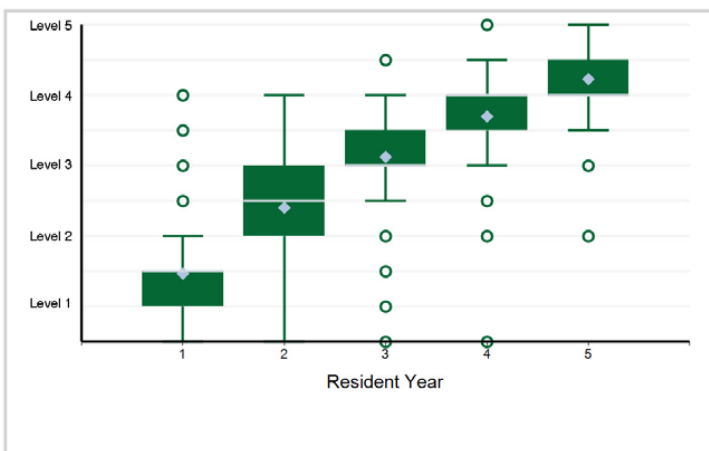

Specialty Box Plot Report - Milestone Evaluation by Resident Year: Year-End 2021-2022

SPECIALTY: Interventional Radiology - Integrated

19. Systems-Based Practice - Systems-Based Practice 7: Contrast Agent Safety

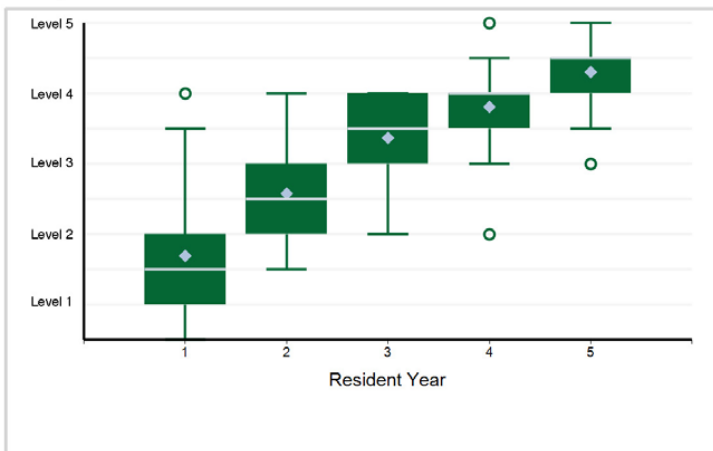

20. Systems-Based Practice - Systems-Based Practice 8: Radiation Safety

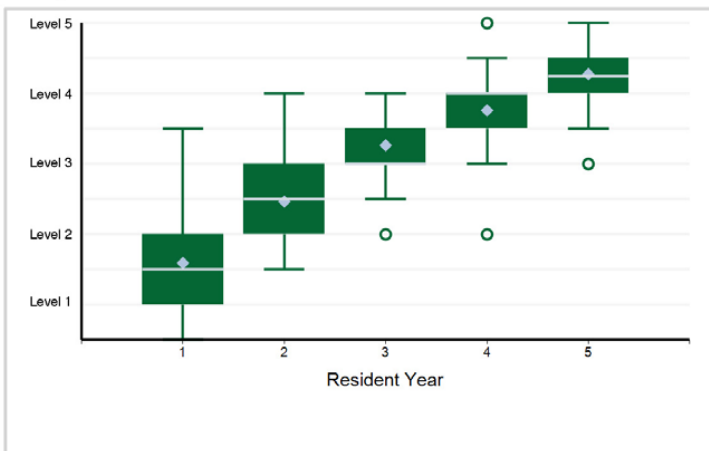

21. Systems-Based Practice - Systems-Based Practice 9: Magnetic Resonance (MR) Safety

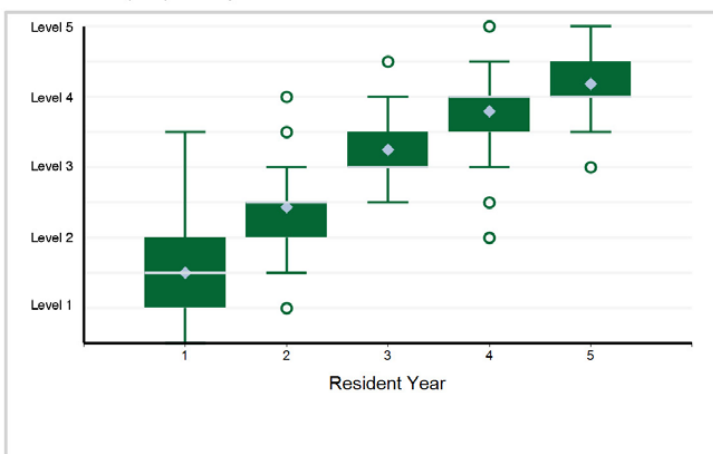

22. Systems-Based Practice - Systems-Based Practice 10: Informatics

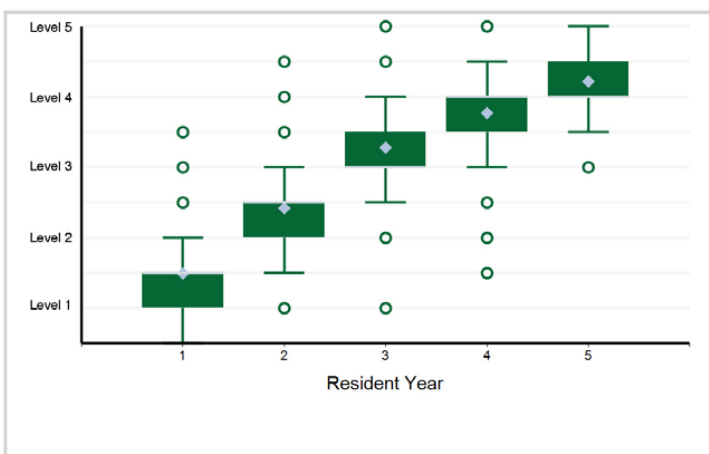

23. Practice-Based Learning and Improvement - Practice-Based Learning and Improvement 1: Evidence-Based and Informed Practice

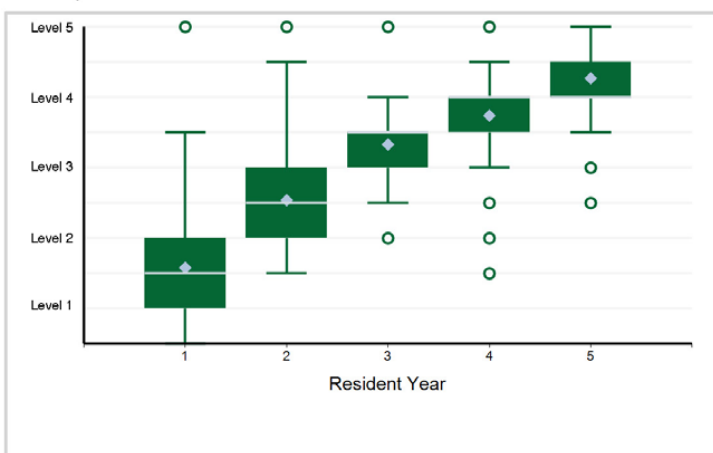

24. Practice-Based Learning and Improvement - Practice-Based Learning and Improvement 2: Reflective Practice and Commitment ...

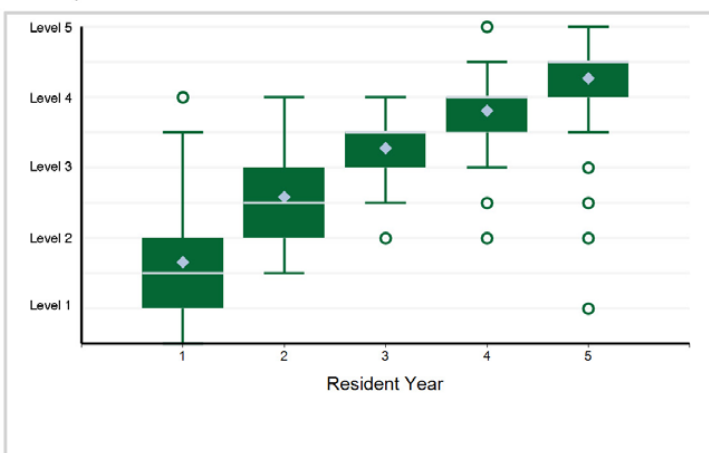

Specialty Box Plot Report - Milestone Evaluation by Resident Year: Year-End 2021-2022

SPECIALTY: Interventional Radiology - Integrated

25. Professionalism - Professionalism 1: Professional Behavior

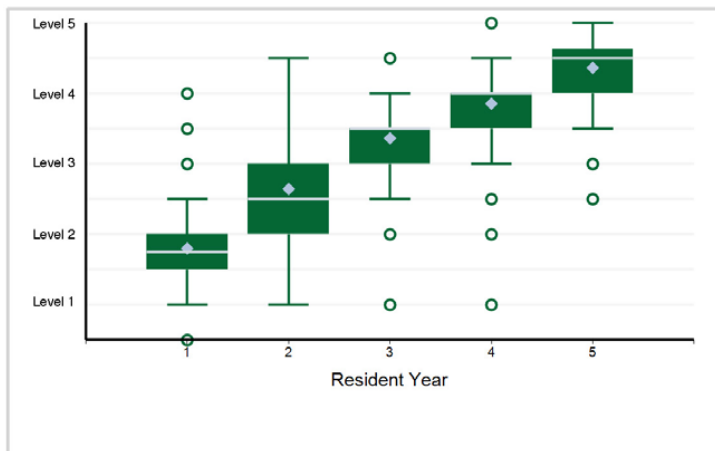

26. Professionalism - Professionalism 2: Ethical Principles

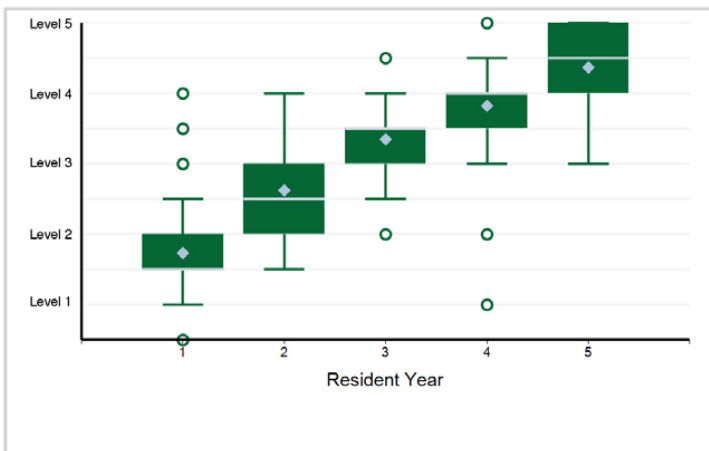

27. Professionalism - Professionalism 3: Accountability/Conscientiousness

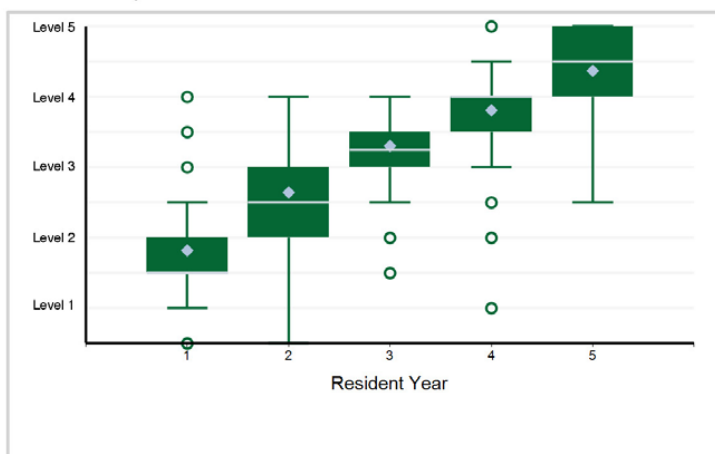

28. Professionalism - Professionalism 4: Self-Awareness and Help-Seeking

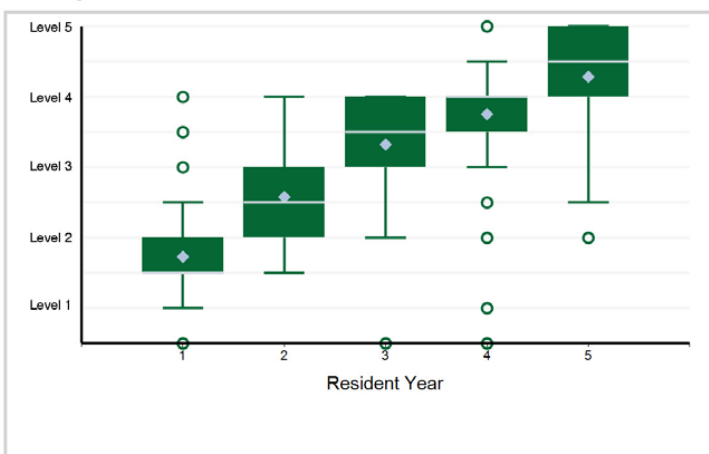

29. Interpersonal and Communication Skills - Interpersonal and Communication Skills 1: Patient- and Family-Centered Communication

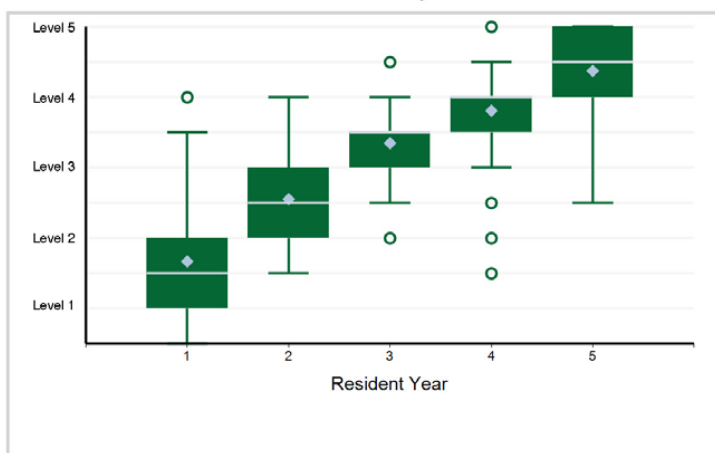

30. Interpersonal and Communication Skills - Interpersonal and Communication Skills 2: Interprofessional and Team Communication

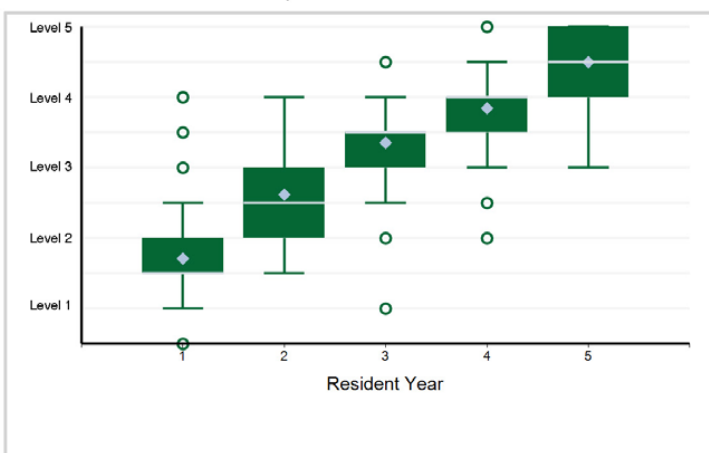

Specialty Box Plot Report - Milestone Evaluation by Resident Year: Year-End 2021-2022

SPECIALTY: **Interventional Radiology - Integrated**

31. Interpersonal and Communication Skills - Interpersonal and Communication Skills 3: Communication within Health Care Systems

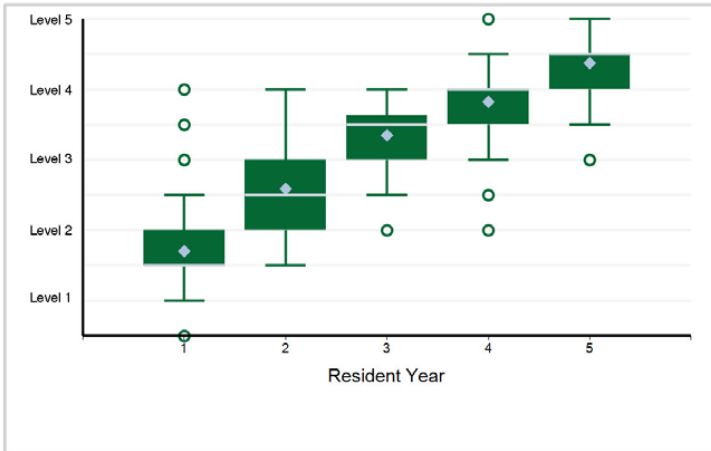

Specialty Box Plot Report - Milestone Evaluation by Resident Year: Year-End 2021-2022

TABLE 139: SPECIALTY: **Surgery**

Resident Year	1	2	3	4	5	Total Residents*
# of Residents	2,860	1,832	1,631	1,533	1,477	9,333

*Note: There are 4 residents with an incomplete milestone evaluation that are excluded from the box plots below.

1. Patient Care - Patient Care 1: Patient Evaluation and Decision Making

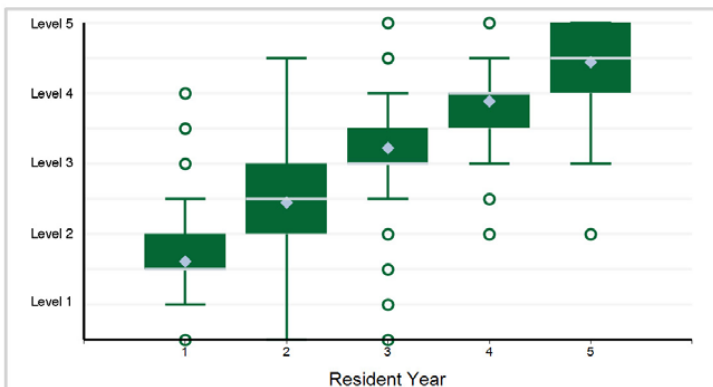

Note: 2 of 9,329 residents have a status of "Not Yet Rotated" and are not included in the analysis.

2. Patient Care - Patient Care 2: Intra-Operative Patient Care – Performance of Procedures

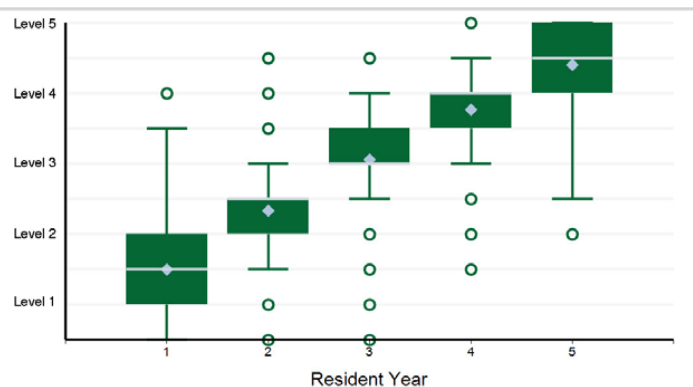

Note: 9 of 9,329 residents have a status of "Not Yet Rotated" and are not included in the analysis.

3. Patient Care - Patient Care 3: Intra-Operative Patient Care – Technical Skills

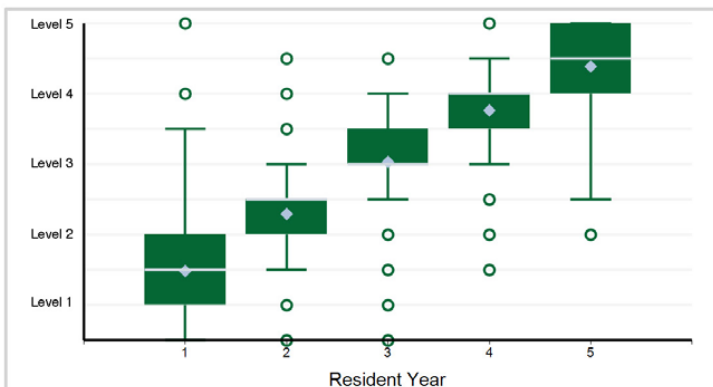

Note: 7 of 9,329 residents have a status of "Not Yet Rotated" and are not included in the analysis.

4. Patient Care - Patient Care 4: Post-Operative Patient Care

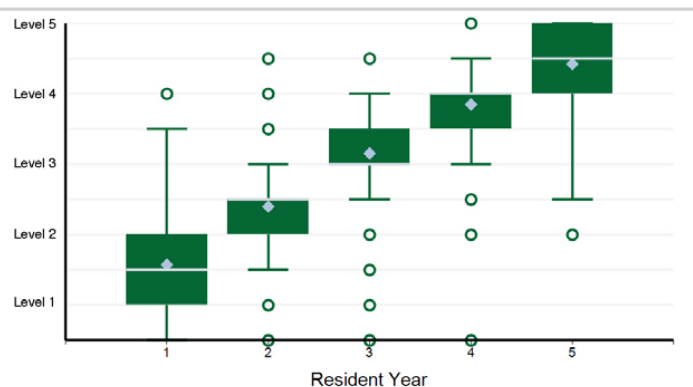

Note: 3 of 9,329 residents have a status of "Not Yet Rotated" and are not included in the analysis.

5. Medical Knowledge - Medical Knowledge 1: Pathophysiology and Treatment

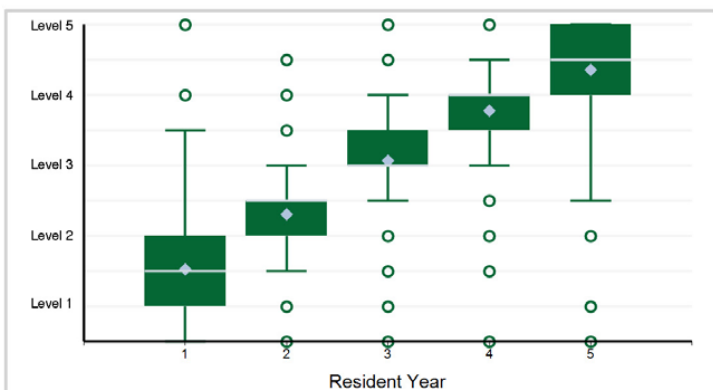

Note: 2 of 9,329 residents have a status of "Not Yet Rotated" and are not included in the analysis.

6. Medical Knowledge - Medical Knowledge 2: Anatomy

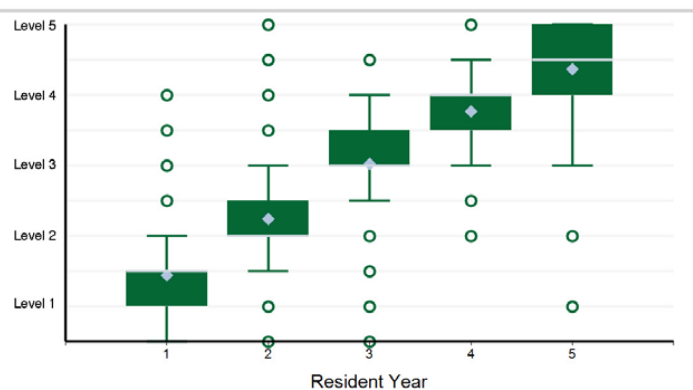

Note: 8 of 9,329 residents have a status of "Not Yet Rotated" and are not included in the analysis.

Specialty Box Plot Report - Milestone Evaluation by Resident Year: Year-End 2021-2022

SPECIALTY: **Surgery**

7. Systems-Based Practice - Systems-Based Practice 1: Patient Safety and Quality Improvement

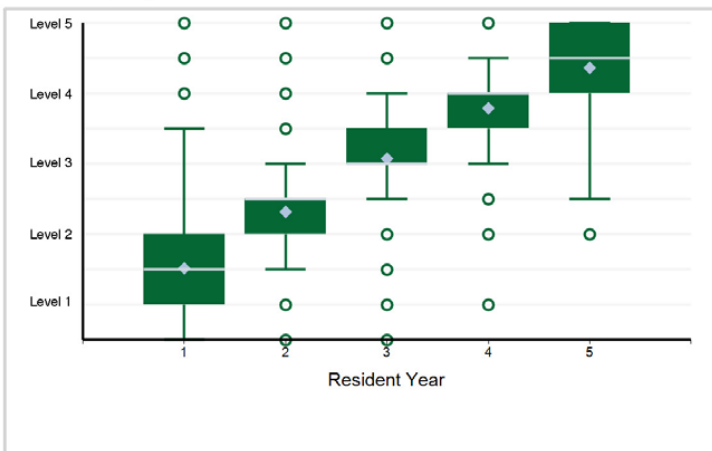

8. Systems-Based Practice - Systems-Based Practice 2: System Navigation for Patient-Centered Care

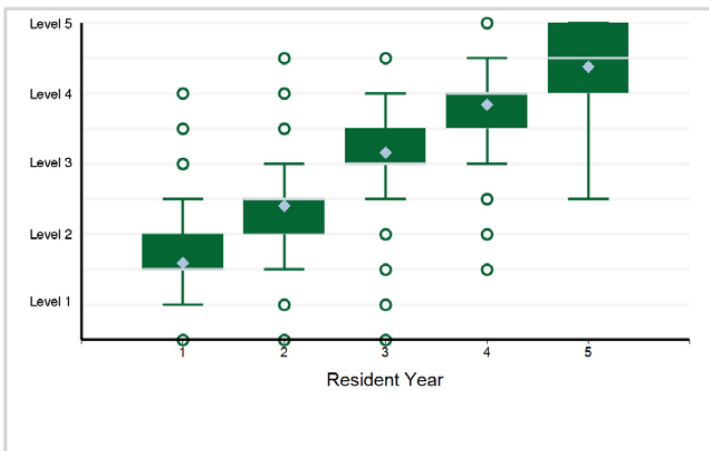

9. Systems-Based Practice - Systems-Based Practice 3: Physician Role in Health Care Systems

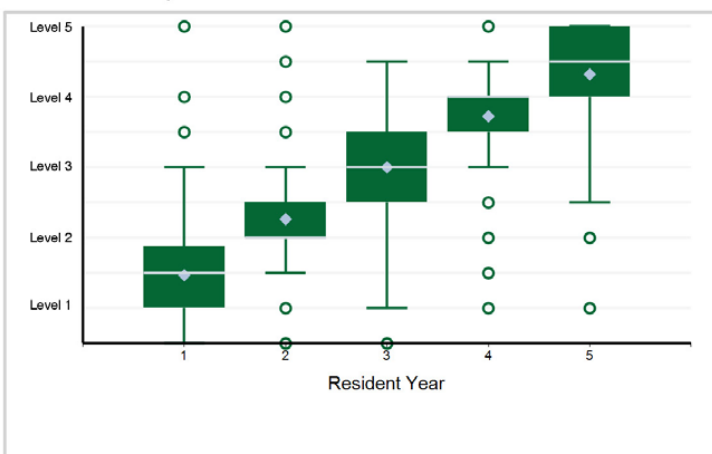

10. Practice-Based Learning and Improvement - Practice-Based Learning and Improvement 1: Evidence-Based and Informed Practice

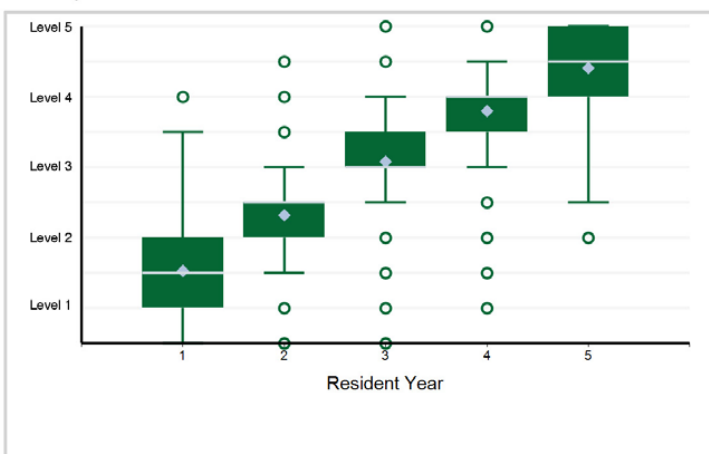

11. Practice-Based Learning and Improvement - Practice-Based Learning and Improvement 2: Reflective Practice and Commitment ...

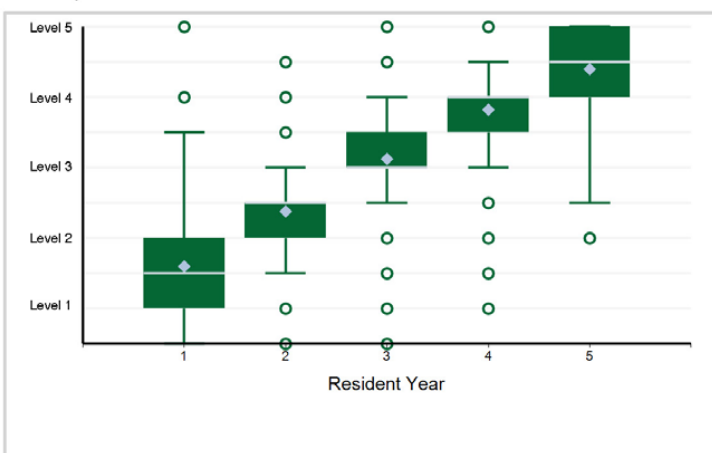

12. Professionalism - Professionalism 1: Ethical Principles

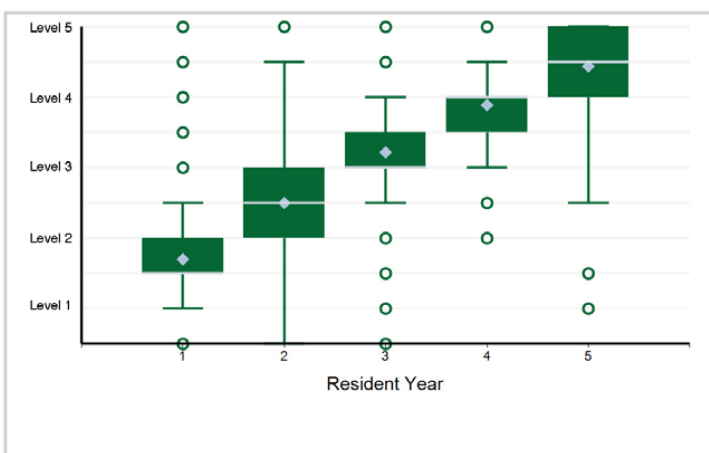

Specialty Box Plot Report - Milestone Evaluation by Resident Year: Year-End 2021-2022

SPECIALTY: **Surgery**

13. Professionalism - Professionalism 2: Professional Behavior and Accountability

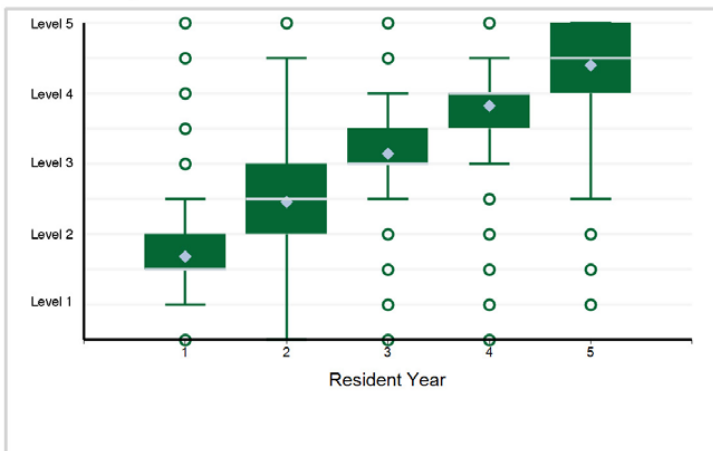

14. Professionalism - Professionalism 3: Administrative Tasks

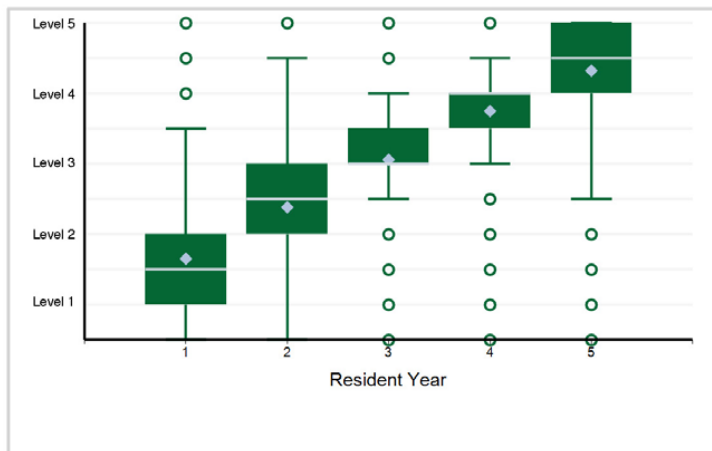

15. Professionalism - Professionalism 4: Self-Awareness and Help-Seeking

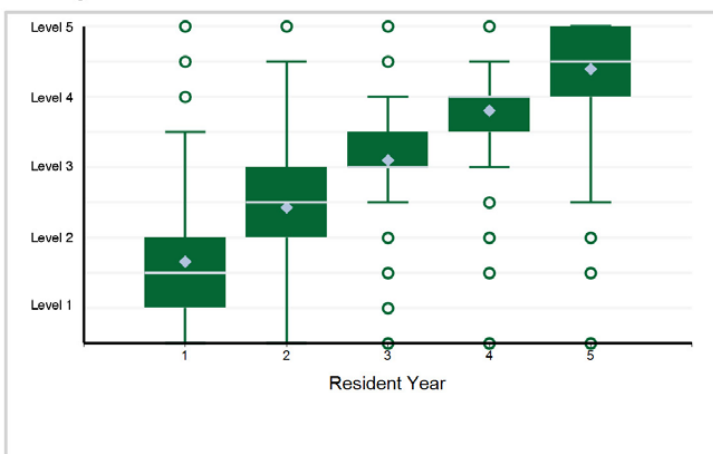

16. Interpersonal and Communication Skills - Interpersonal and Communication Skills 1: Patient and Family-Centered Communication

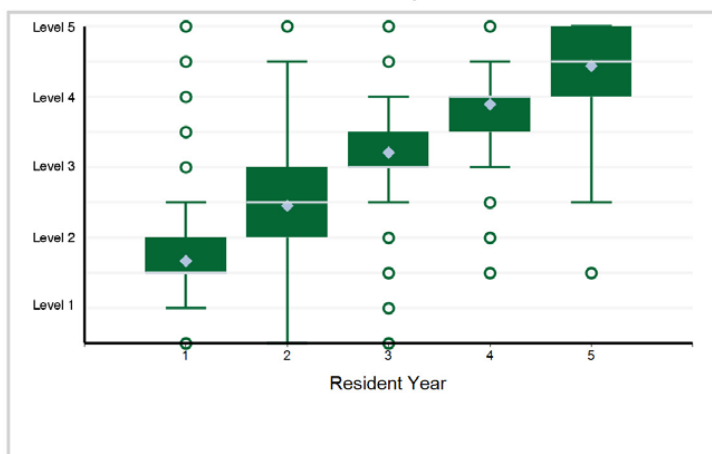

17. Interpersonal and Communication Skills - Interpersonal and Communication Skills 2: Interprofessional and Team Communication

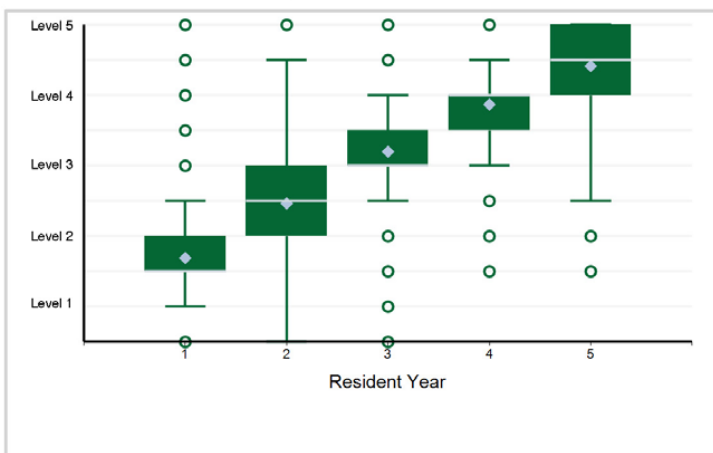

18. Interpersonal and Communication Skills - Interpersonal and Communication Skills 3: Communication within Health Care Systems

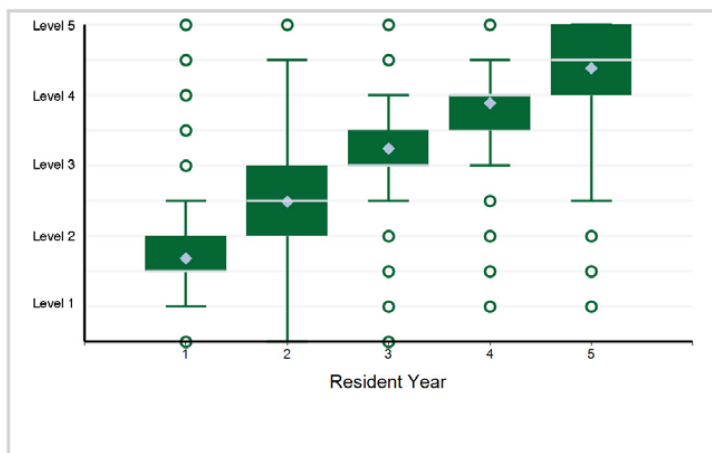

Specialty Box Plot Report - Milestone Evaluation by Resident Year: Year-End 2021-2022

TABLE 140: SUBSPECIALTY: **Complex General Surgical Oncology**

Resident Year	1	2	Total Residents
# of Residents	62	62	124

1. Patient Care - Patient Care 1: Patient Evaluation and Clinical Decision Making

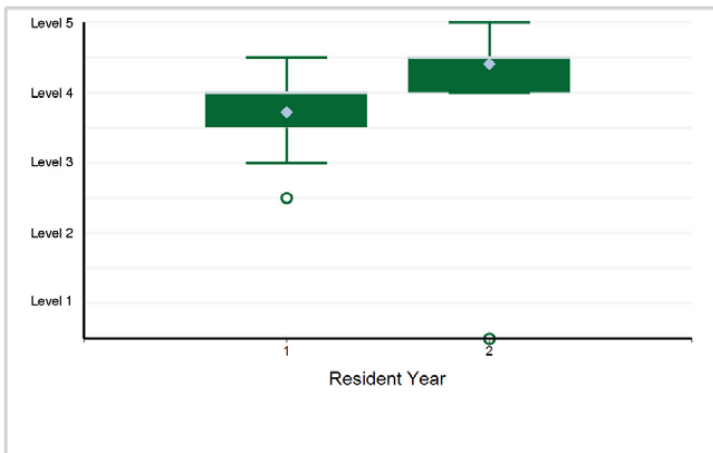

2. Patient Care - Patient Care 2: Management of Intra-Operative Complications

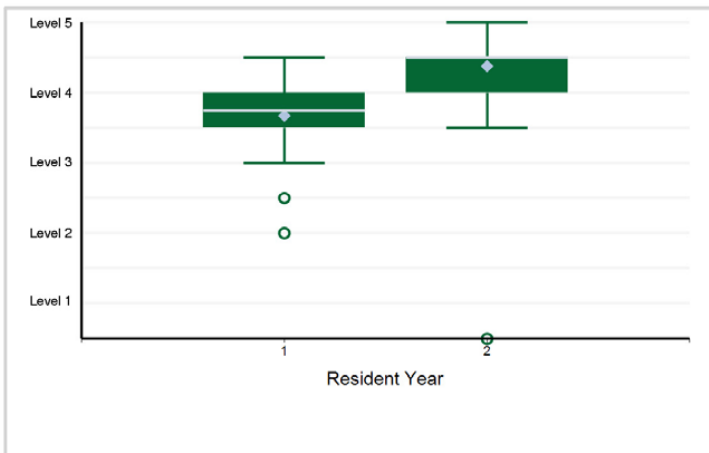

3. Patient Care - Patient Care 3: Intra-Operative Oncologic Decision Making

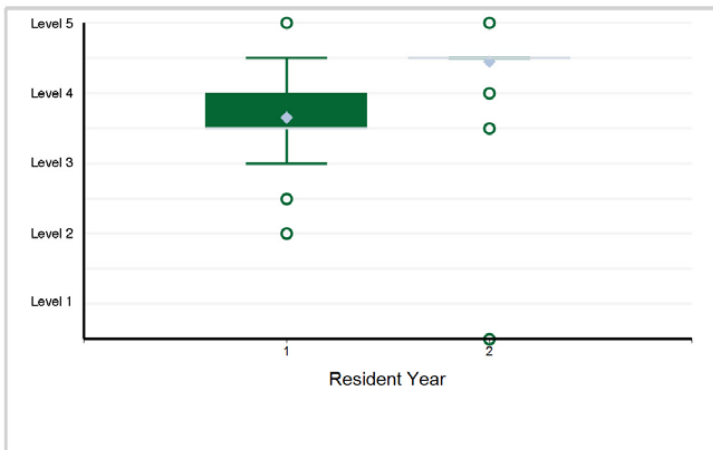

4. Patient Care - Patient Care 4: Intra-Operative Patient Care – Procedural Skills

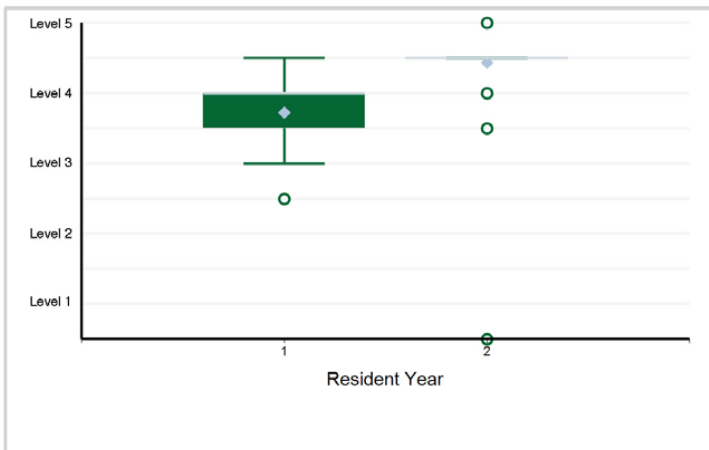

5. Patient Care - Patient Care 5: Intra-Operative Patient Care – Operative Autonomy

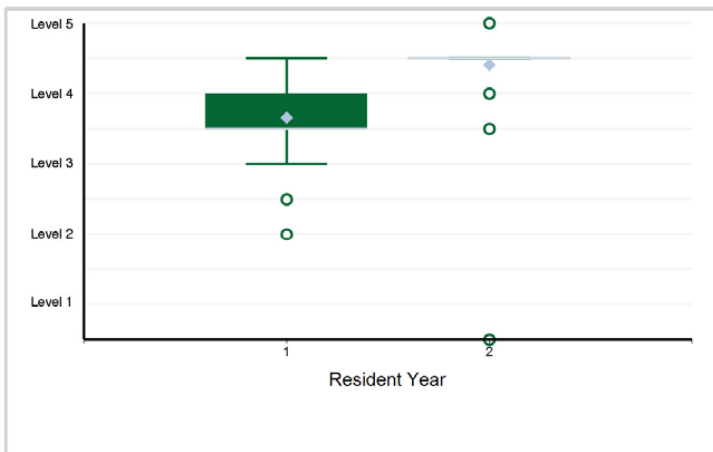

6. Patient Care - Patient Care 6: Immediate Post-Operative Care

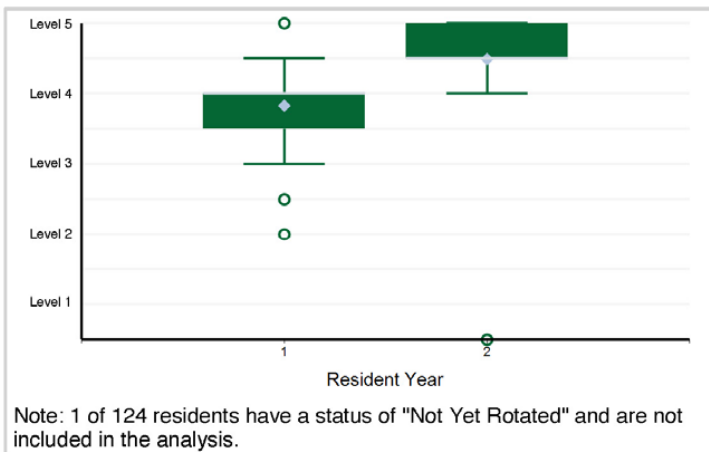

Note: 1 of 124 residents have a status of "Not Yet Rotated" and are not included in the analysis.

Specialty Box Plot Report - Milestone Evaluation by Resident Year: Year-End 2021-2022

SUBSPECIALTY: Complex General Surgical Oncology

7. Patient Care - Patient Care 7: Post-Operative Oncologic Management

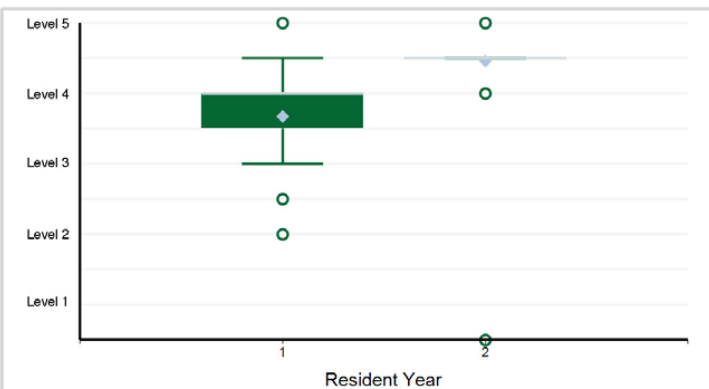

Note: 1 of 124 residents have a status of "Not Yet Rotated" and are not included in the analysis.

8. Medical Knowledge - Medical Knowledge 1: Anatomy

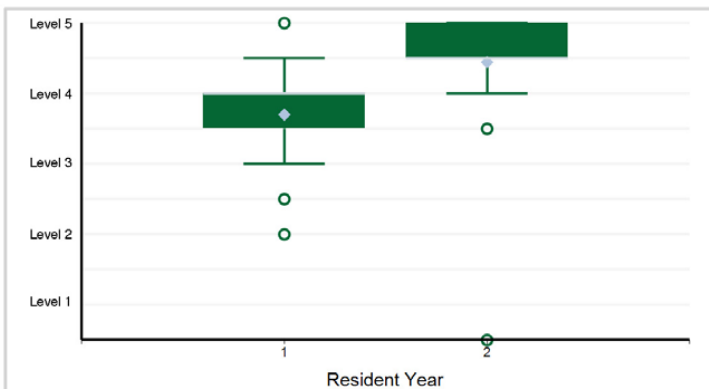

Note: 1 of 124 residents have a status of "Not Yet Assessable" and are not included in the analysis.

9. Medical Knowledge - Medical Knowledge 2: Cancer Biology

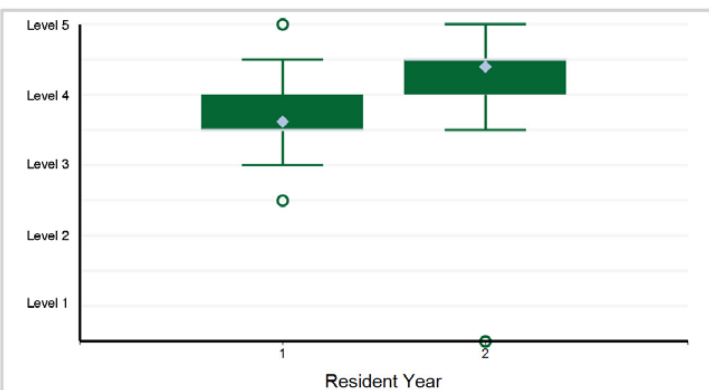

Note: 1 of 124 residents have a status of "Not Yet Assessable" and are not included in the analysis.

10. Medical Knowledge - Medical Knowledge 3: Therapeutics

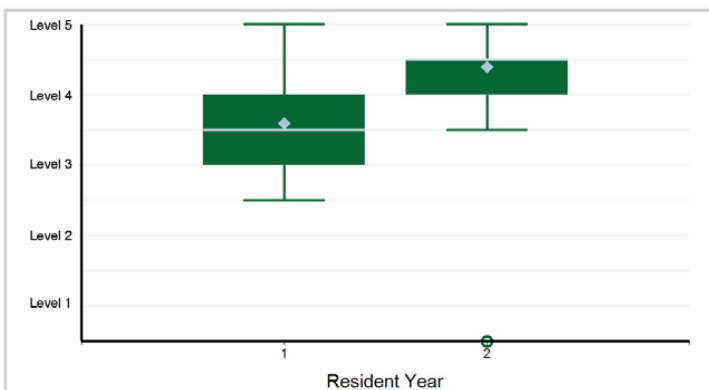

Note: 1 of 124 residents have a status of "Not Yet Assessable" and are not included in the analysis.

11. Medical Knowledge - Medical Knowledge 4: Clinical Trials

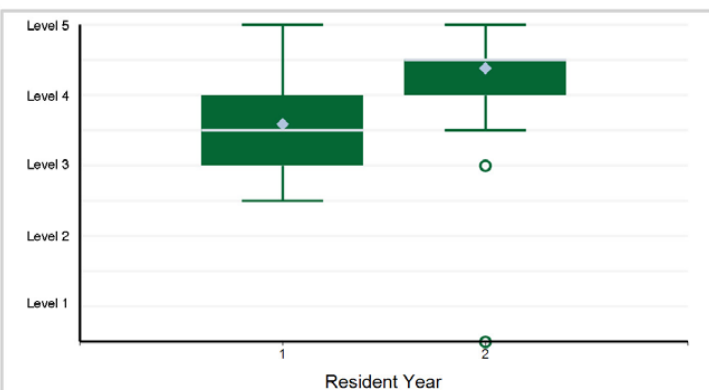

Note: 1 of 124 residents have a status of "Not Yet Assessable" and are not included in the analysis.

12. Systems-Based Practice - Systems-Based Practice 1: Patient Safety and Quality Improvement

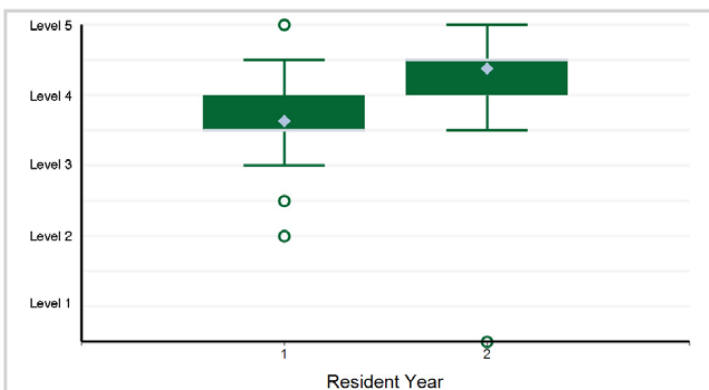

Specialty Box Plot Report - Milestone Evaluation by Resident Year: Year-End 2021-2022

SUBSPECIALTY: Complex General Surgical Oncology

13. Systems-Based Practice - Systems-Based Practice 2: System Navigation for Patient-Centered Care

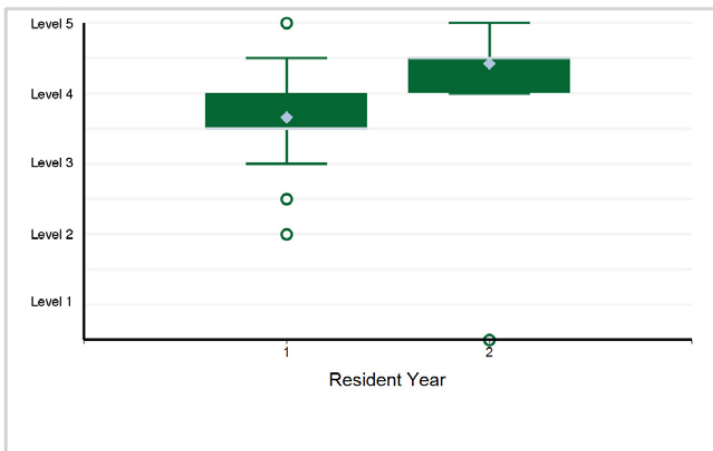

14. Systems-Based Practice - Systems-Based Practice 3: Physician Role in Health Care Systems

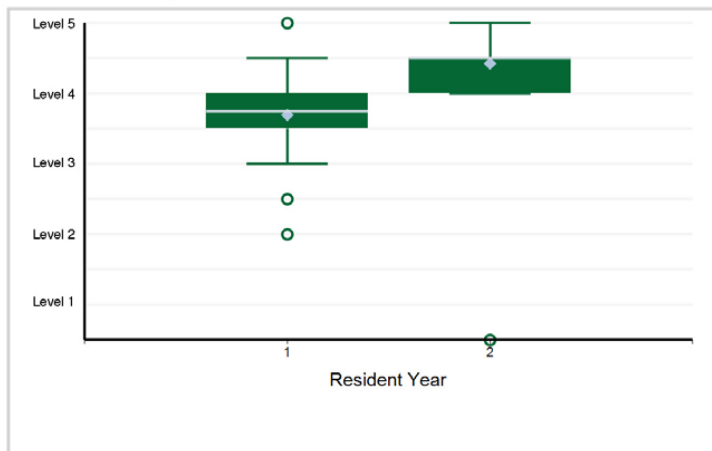

15. Practice-Based Learning and Improvement - Practice-Based Learning and Improvement 1: Evidence-Based and Informed Practice

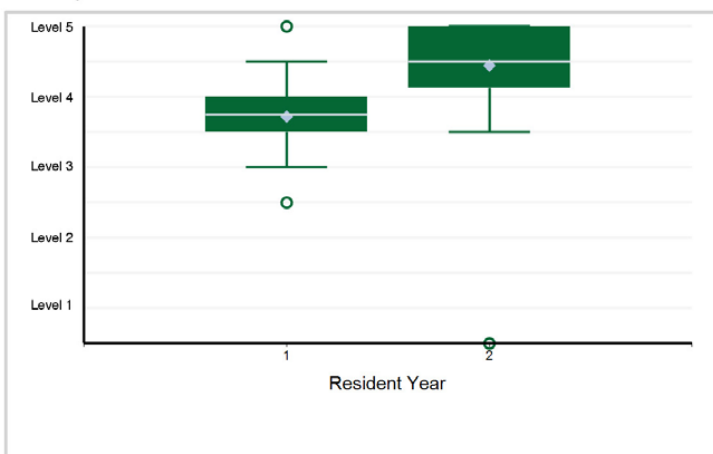

16. Practice-Based Learning and Improvement - Practice-Based Learning and Improvement 2: Reflective Practice and Commitment ...

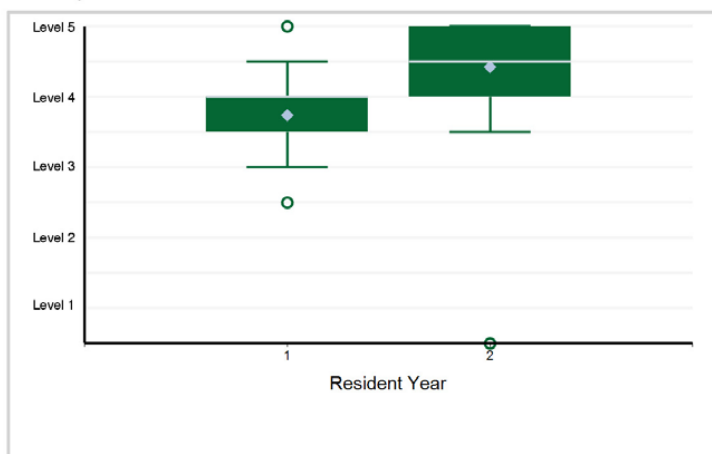

17. Practice-Based Learning and Improvement - Practice-Based Learning and Improvement 3: Scholarly Activity

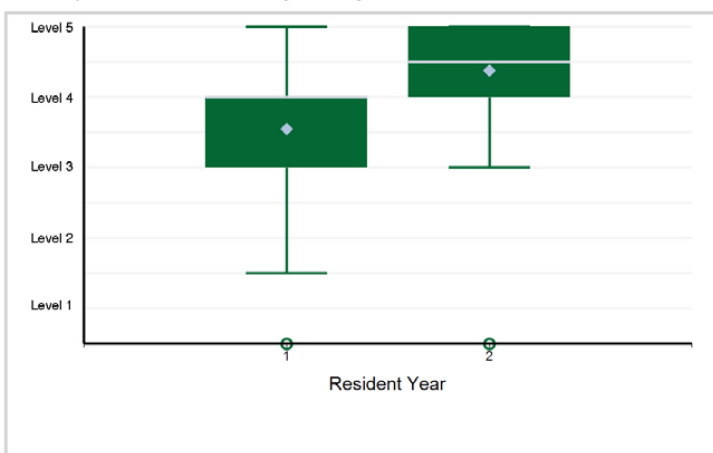

18. Professionalism - Professionalism 1: Professional Behavior and Ethical Principles

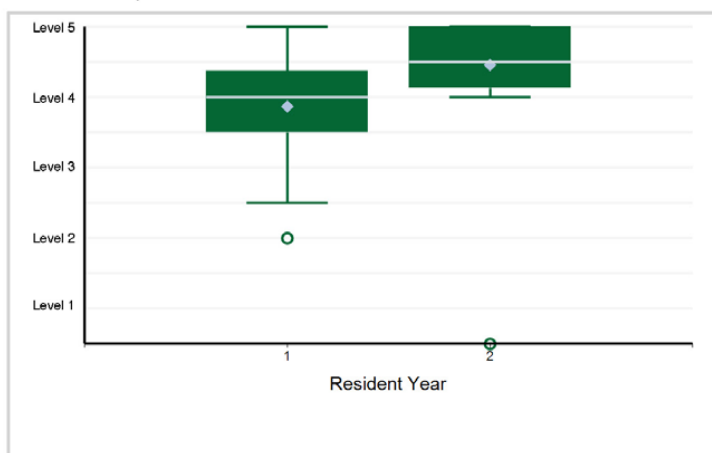

Specialty Box Plot Report - Milestone Evaluation by Resident Year: Year-End 2021-2022

SUBSPECIALTY: Complex General Surgical Oncology

19. Professionalism - Professionalism 2: Accountability/Conscientiousness

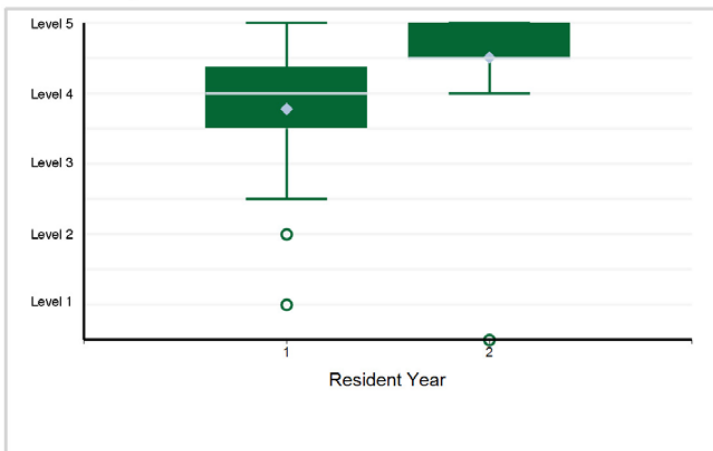

20. Professionalism - Professionalism 3: Well-Being

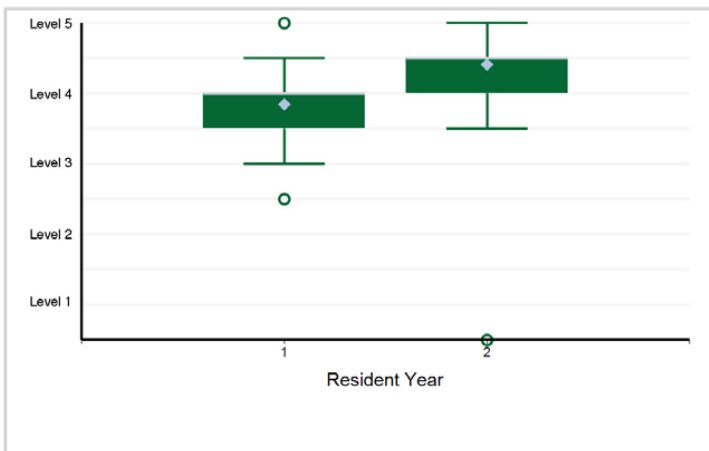

21. Interpersonal and Communication Skills - Interpersonal and Communication Skills 1: Patient- and Family-Centered Communication

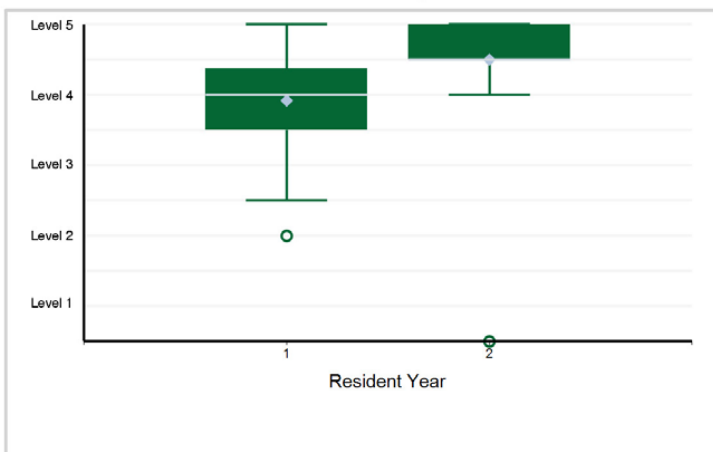

22. Interpersonal and Communication Skills - Interpersonal and Communication Skills 2: Interprofessional and Team Communication

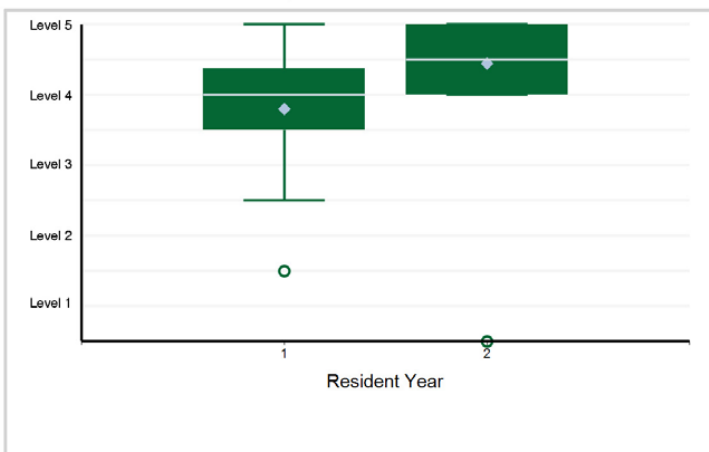

23. Interpersonal and Communication Skills - Interpersonal and Communication Skills 3: Communication within Health Care Systems

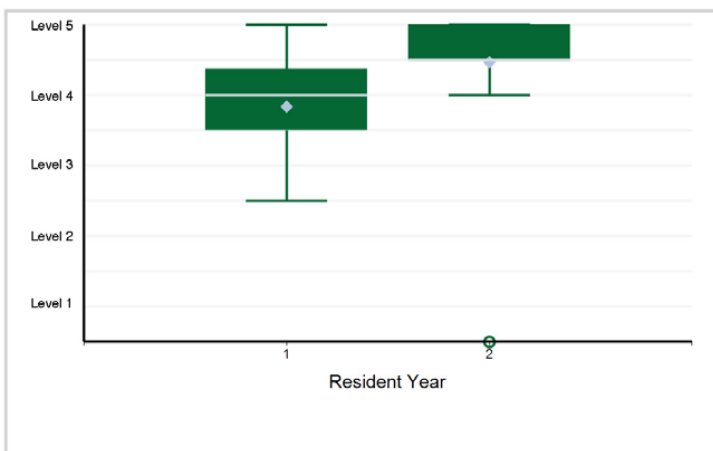

Specialty Box Plot Report - Milestone Evaluation by Resident Year: Year-End 2021-2022

TABLE 141: SUBSPECIALTY: **Pediatric Surgery**

Resident Year	1	2	Total Residents
# of Residents	47	39	86

1. Patient Care - Bronchoscopy/Esophagoscopy — Patient Care

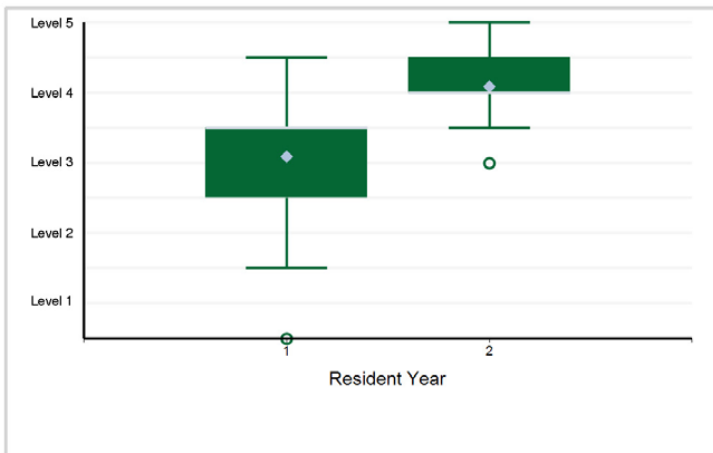

2. Patient Care - Esophageal atresia/Tracheoesophageal Fistula (TEF) Repair — Patient Care

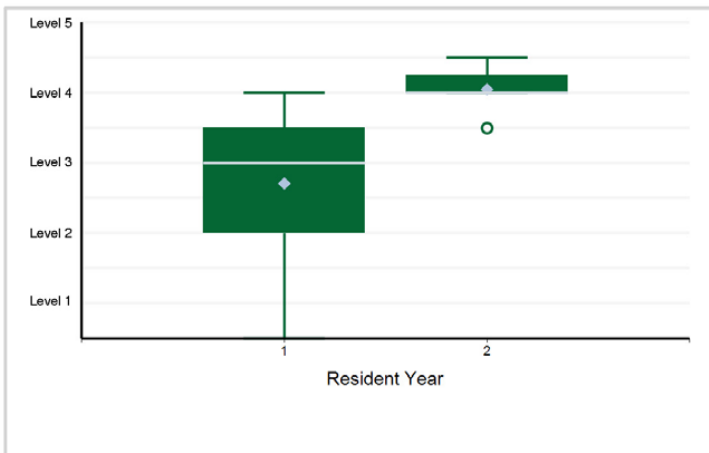

3. Patient Care - Inguinal hernia repair on a child less than six months of age — Patient Care

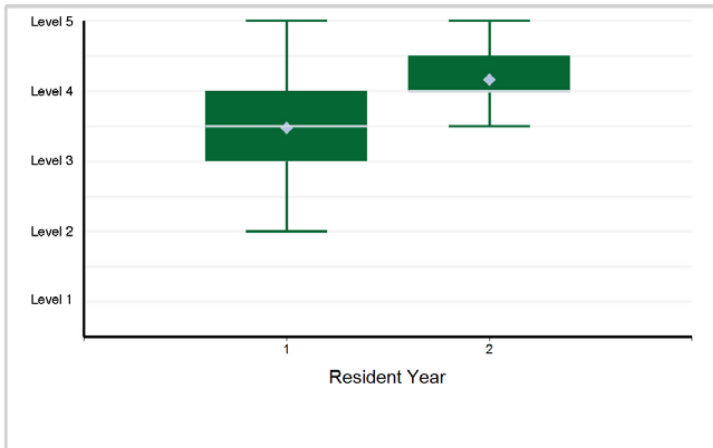

4. Patient Care - Intestinal/duodenal atresia (DA) repair — Patient Care

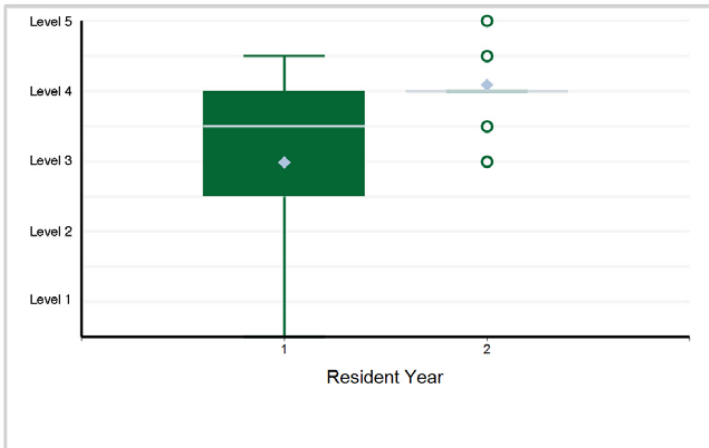

5. Patient Care - Hirschsprung pull through — Patient Care

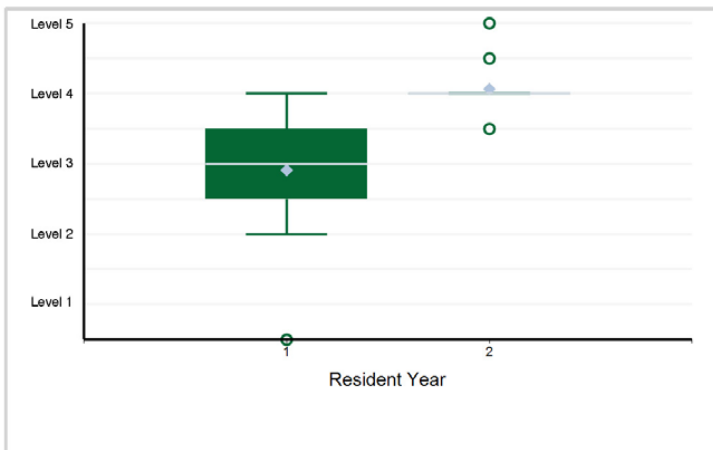

6. Patient Care - Wilms/Neuroblastoma Resection — Patient Care

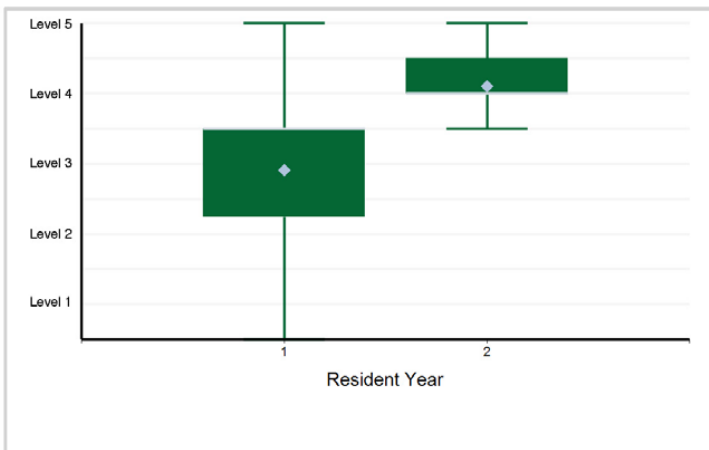

Specialty Box Plot Report - Milestone Evaluation by Resident Year: Year-End 2021-2022

SUBSPECIALTY: Pediatric Surgery

7. Patient Care - Congenital Diaphragmatic Hernia Repair — Patient Care

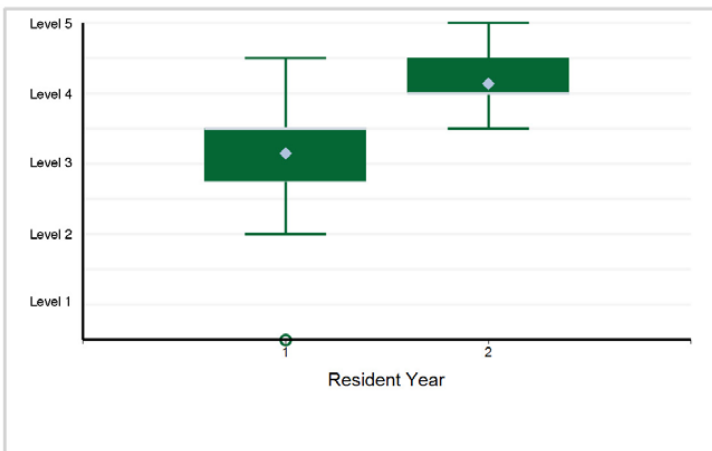

8. Patient Care - General Procedure Assessment — Patient Care

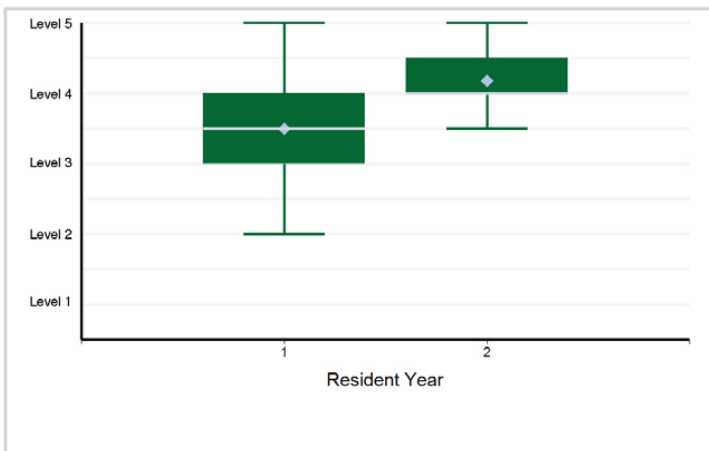

9. Patient Care - General Patient Care Assessment — Patient Care

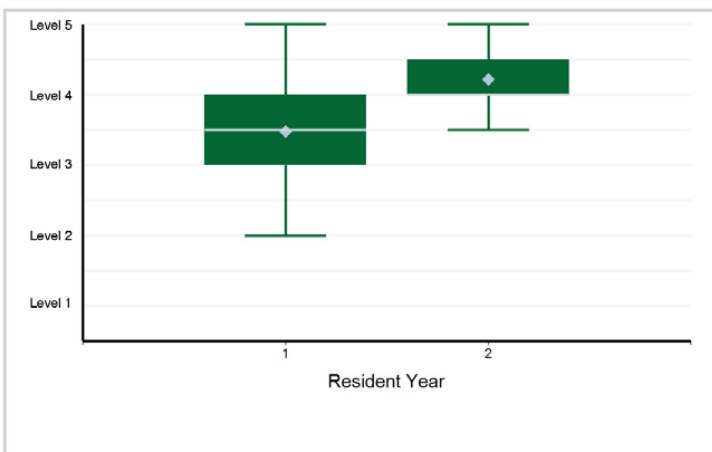

10. Medical Knowledge - Medical Knowledge

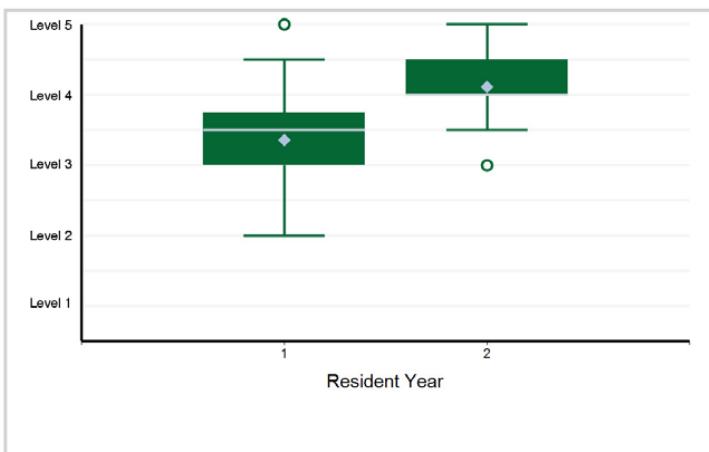

11. Medical Knowledge - General Knowledge Assessment — Medical Knowledge

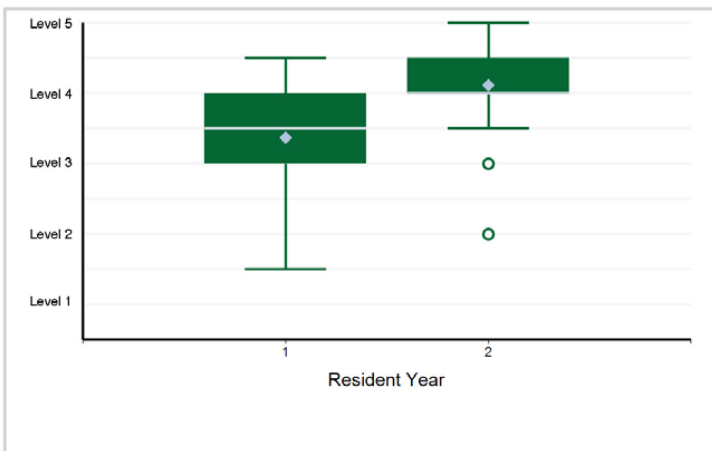

12. Systems-Based Practice - Healthcare Delivery and Cost — Systems-Based Practice

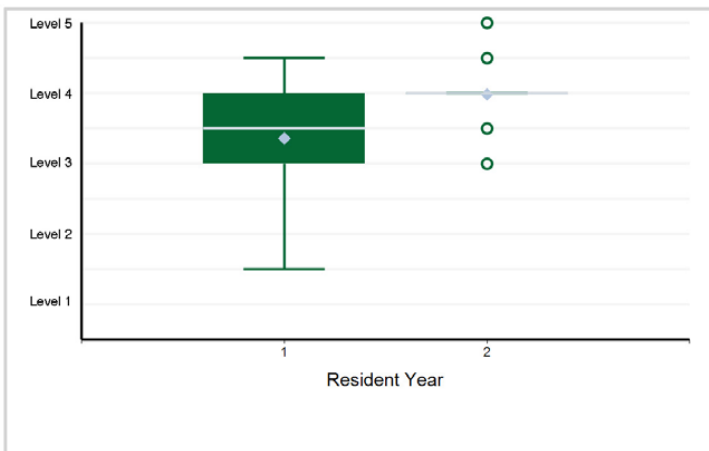

Specialty Box Plot Report - Milestone Evaluation by Resident Year: Year-End 2021-2022

SUBSPECIALTY: Pediatric Surgery

13. Systems-Based Practice - Patient Safety — Systems-Based Practice

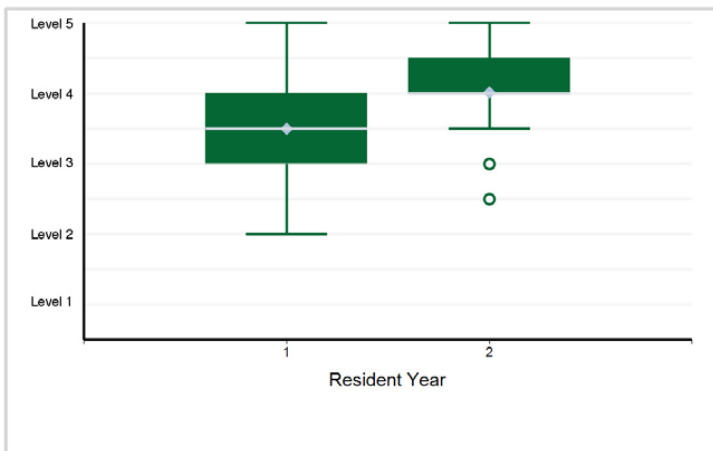

14. Systems-Based Practice - Systems-based Documentation — Systems-Based Practice

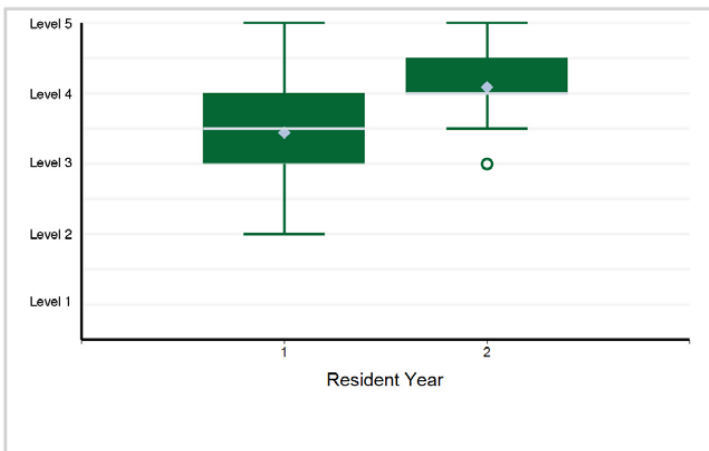

15. Practice-Based Learning and Improvement - Evidence-based Medicine — Practice-Based Learning and Improvement

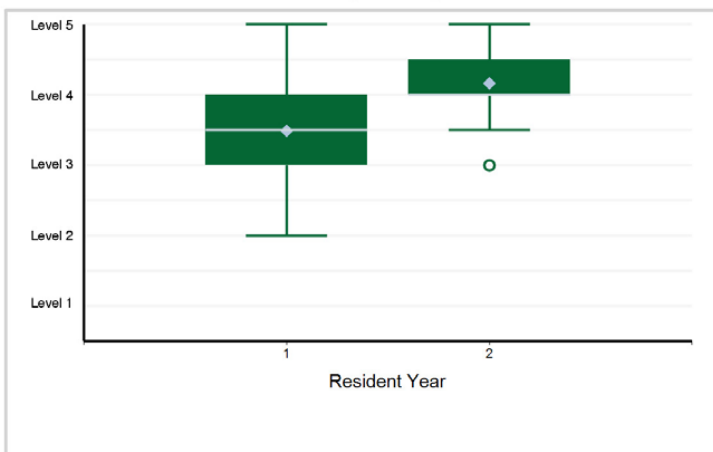

16. Practice-Based Learning and Improvement - Self-directed Learning — Practice-Based Learning and Improvement

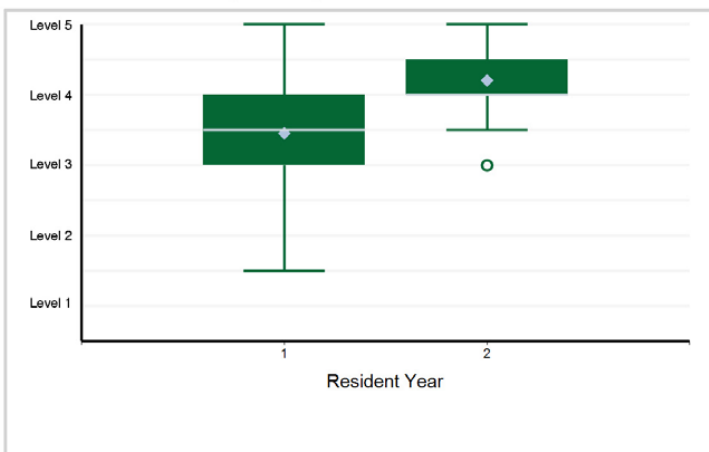

17. Professionalism - Integrity — Professionalism

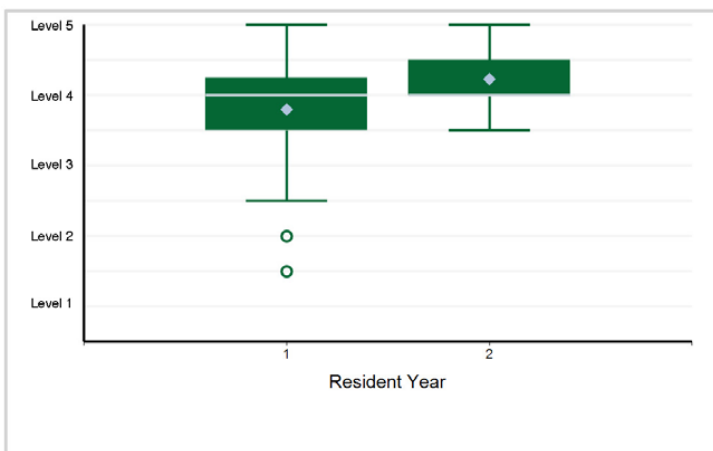

18. Professionalism - Recognition of Limits — Professionalism

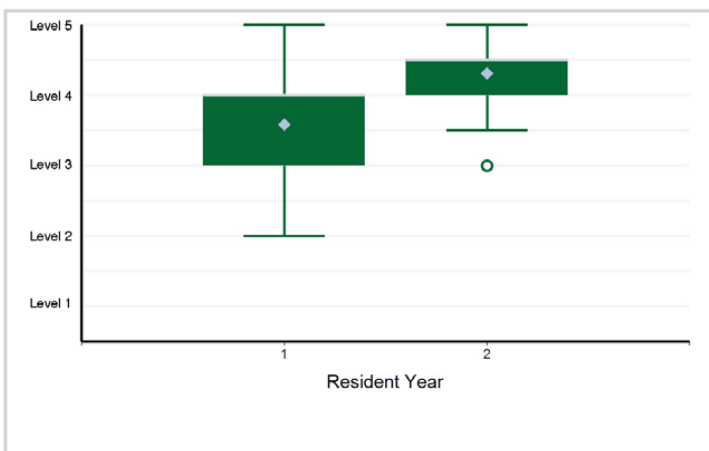

Specialty Box Plot Report - Milestone Evaluation by Resident Year: Year-End 2021-2022

SUBSPECIALTY: Pediatric Surgery

19. Professionalism - Behavior and Respect — Professionalism

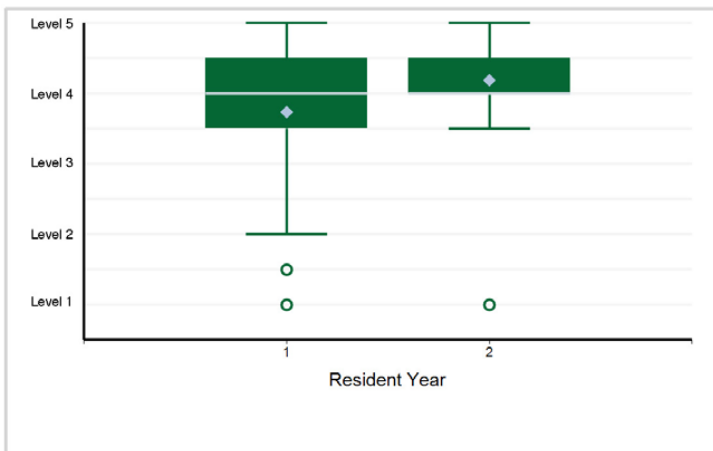

20. Professionalism - Leadership — Professionalism

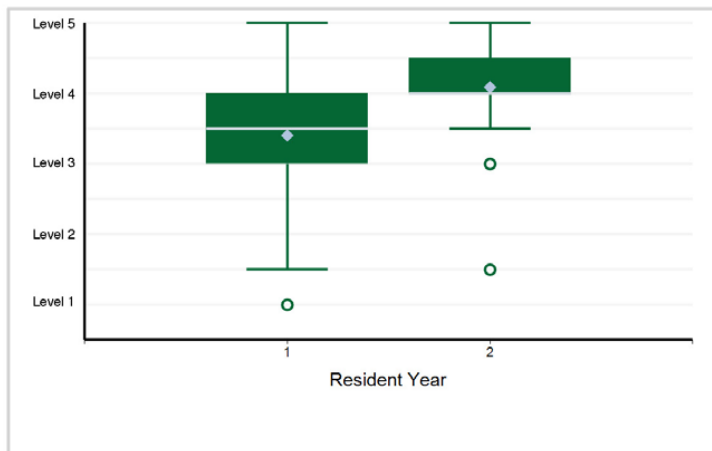

21. Interpersonal and Communication Skills - Collaborator — Interpersonal and Communication Skills

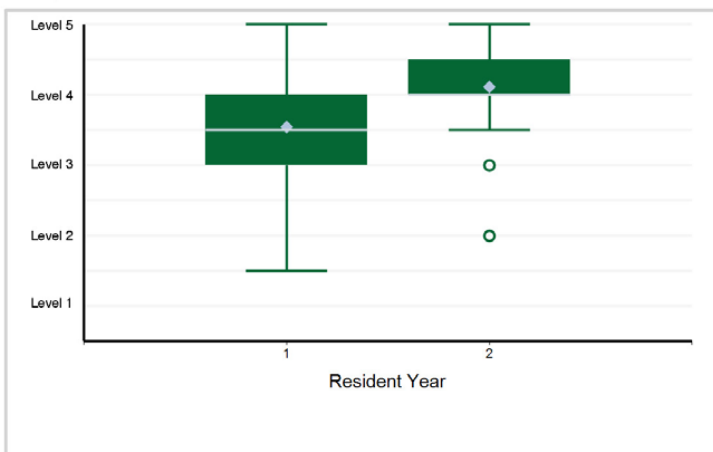

22. Interpersonal and Communication Skills - Patient- and Family-centered Care — Interpersonal and Communication Skills

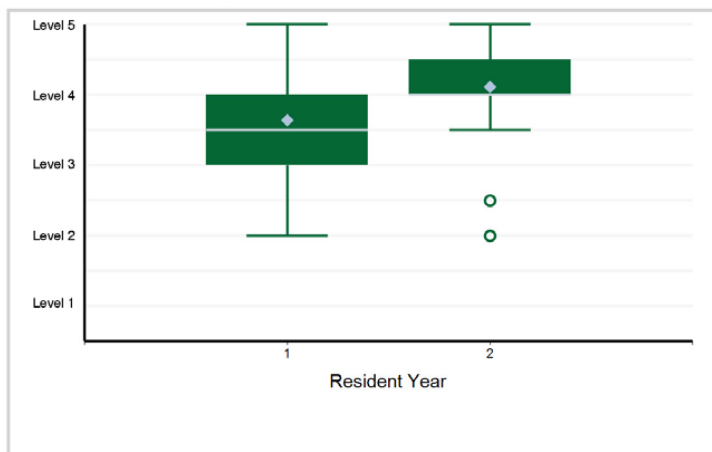

Specialty Box Plot Report - Milestone Evaluation by Resident Year: Year-End 2021-2022

TABLE 142: SUBSPECIALTY: **Surgical Critical Care**

Resident Year	1	Total Residents*
# of Residents	337	337

*Note: There are 1 residents with an incomplete milestone evaluation that are excluded from the box plots below.

1. Patient Care - Patient Care 1: Respiratory Failure

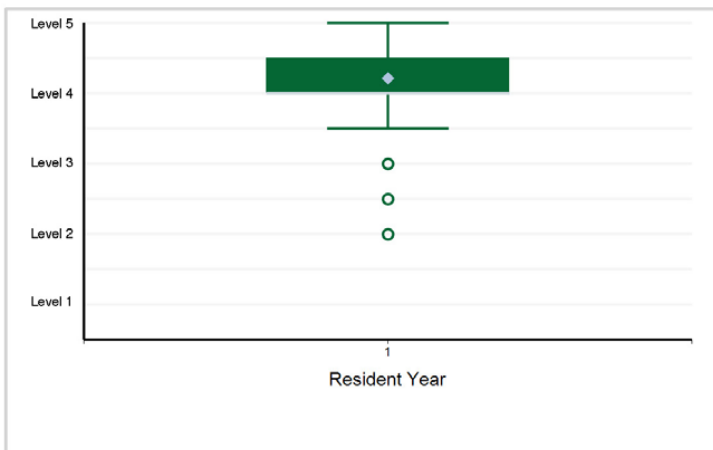

2. Patient Care - Patient Care 2: Nutritional Support

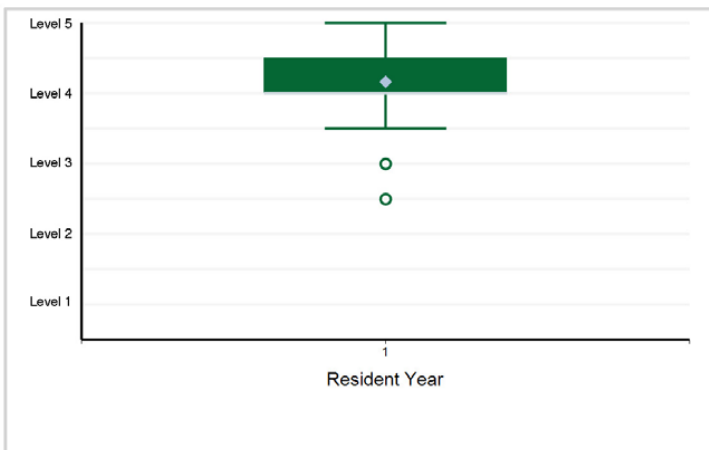

3. Patient Care - Patient Care 3: Shock/Resuscitation



4. Patient Care - Patient Care 4: Renal Disorders of Critically Ill Patients

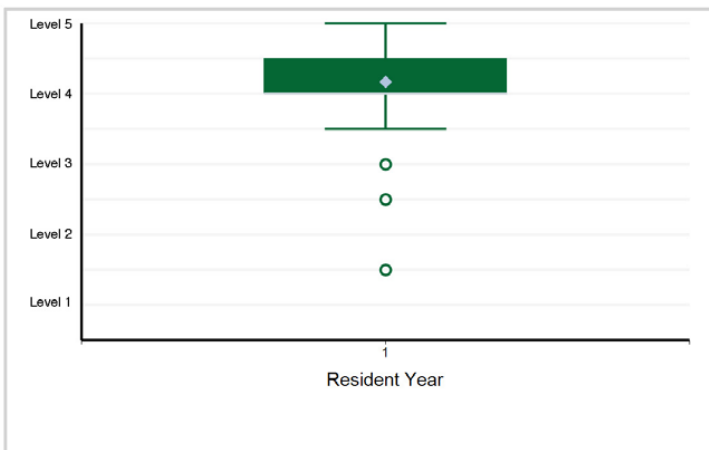

5. Patient Care - Patient Care 5: Trauma and Thermal Injury

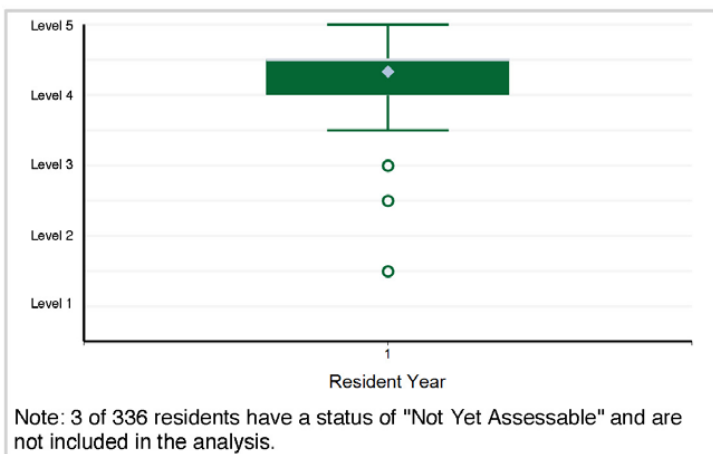

6. Patient Care - Patient Care 6: Cardiovascular Disorders of Critically Ill Patients

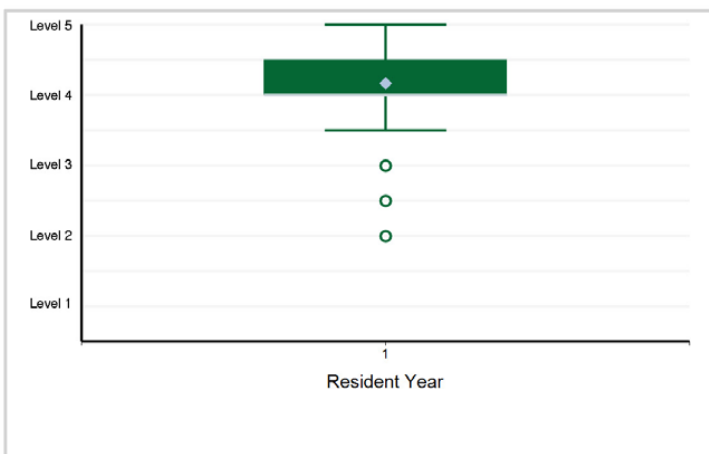

Specialty Box Plot Report - Milestone Evaluation by Resident Year: Year-End 2021-2022

SUBSPECIALTY: Surgical Critical Care

7. Patient Care - Patient Care 7: Neurologic Disorders of Critically Ill Patients

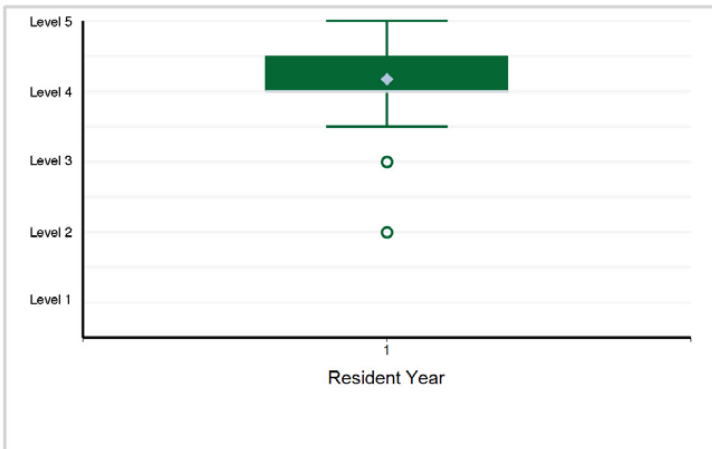

8. Patient Care - Patient Care 8: Gastrointestinal (GI) Disorders of Critically Ill Patients

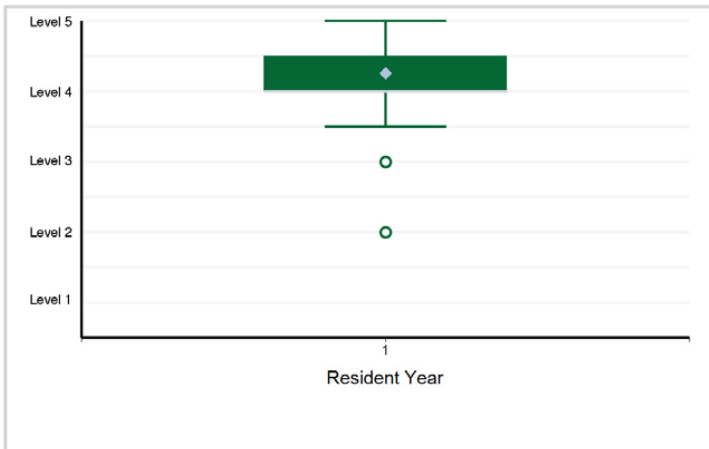

9. Patient Care - Patient Care 9: Infectious Diseases of Critically Ill Surgical Patients



10. Patient Care - Patient Care 10: Procedural Competence

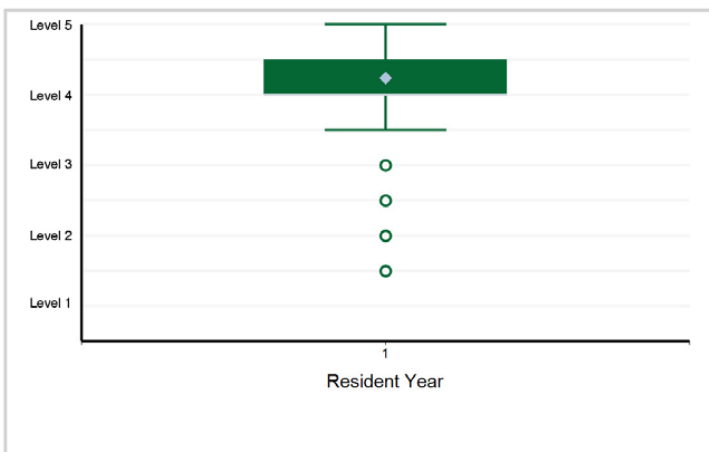

11. Medical Knowledge - Medical Knowledge 1: Pathophysiology, Pharmacology, and Therapeutics in Critical Care

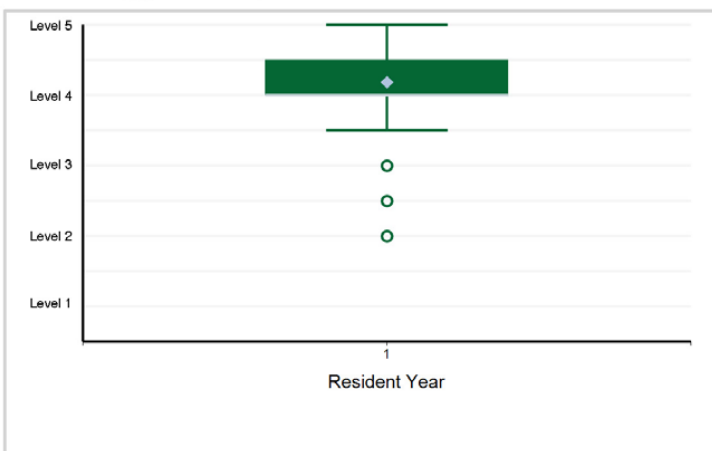

12. Medical Knowledge - Medical Knowledge 2: Prognosis in Critical Care Conditions

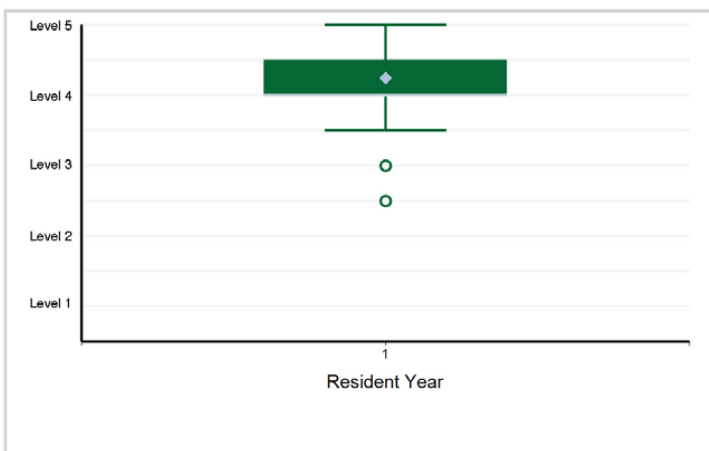

Specialty Box Plot Report - Milestone Evaluation by Resident Year: Year-End 2021-2022

SUBSPECIALTY: Surgical Critical Care

13. Medical Knowledge - Medical Knowledge 3: Clinical Reasoning in Critical Care

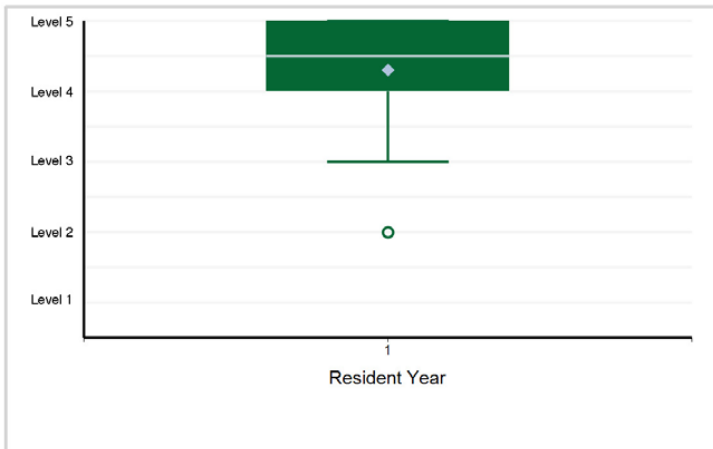

14. Systems-Based Practice - Systems-Based Practice 1: Patient Safety and Quality Improvement



15. Systems-Based Practice - Systems-Based Practice 2: System Navigation for Patient-Centered Care

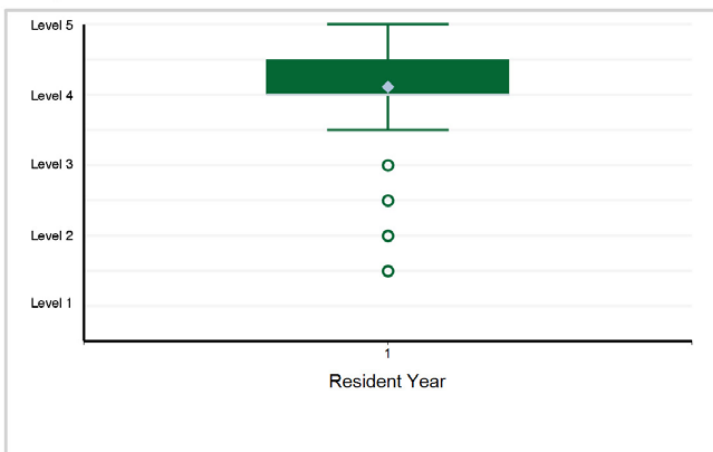

16. Systems-Based Practice - Systems-Based Practice 3: Community and Population Health

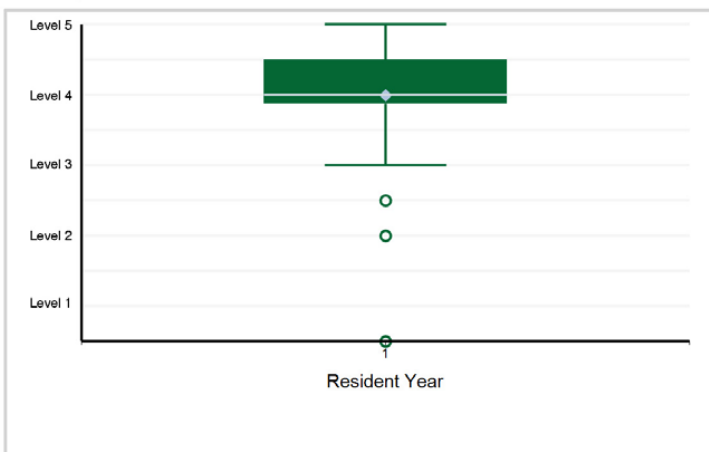

17. Systems-Based Practice - Systems-Based Practice 4: Physician Role in Health Care Systems

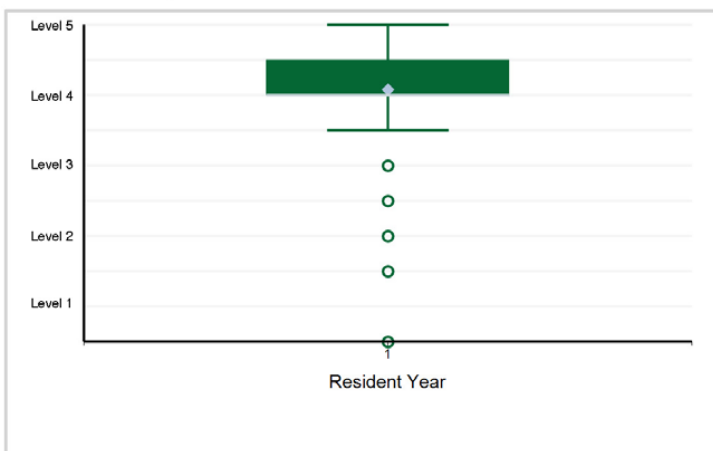

18. Practice-Based Learning and Improvement - Practice-Based Learning and Improvement 1: Evidence-Based and Informed Practice

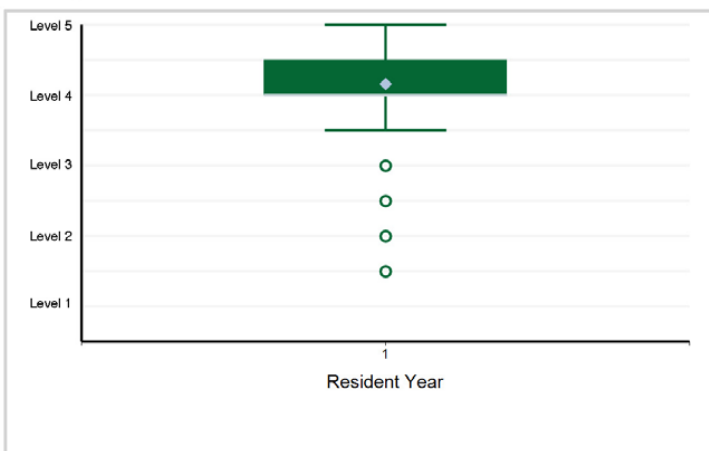

Specialty Box Plot Report - Milestone Evaluation by Resident Year: Year-End 2021-2022

SUBSPECIALTY: Surgical Critical Care

19. Practice-Based Learning and Improvement - Practice-Based Learning and Improvement 2: Reflective Practice and Commitment ...

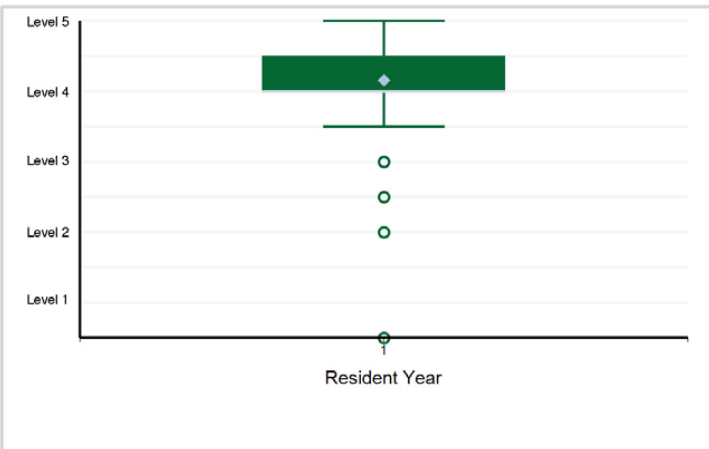

20. Professionalism - Professionalism 1: Ethical Principles

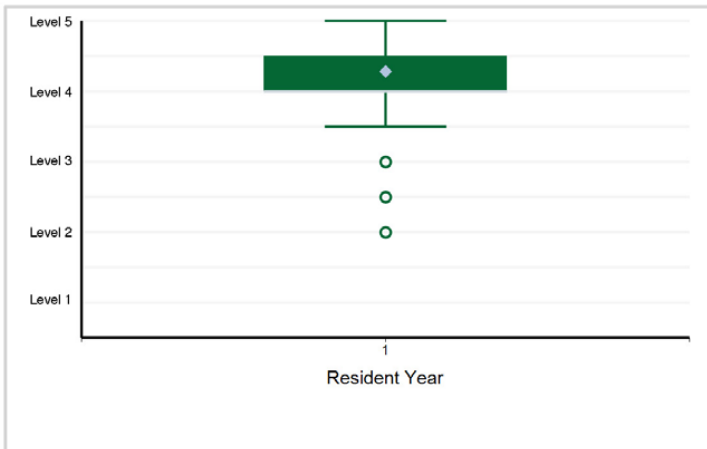

21. Professionalism - Professionalism 2: Professional Behavior and Accountability

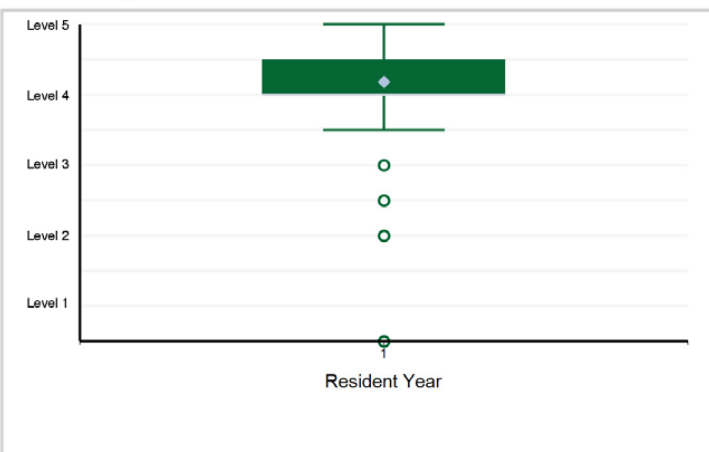

22. Professionalism - Professionalism 3: Self-Awareness and Help-Seeking



23. Interpersonal and Communication Skills - Interpersonal and Communication Skills 1: Patient- and Family-Centered Communication

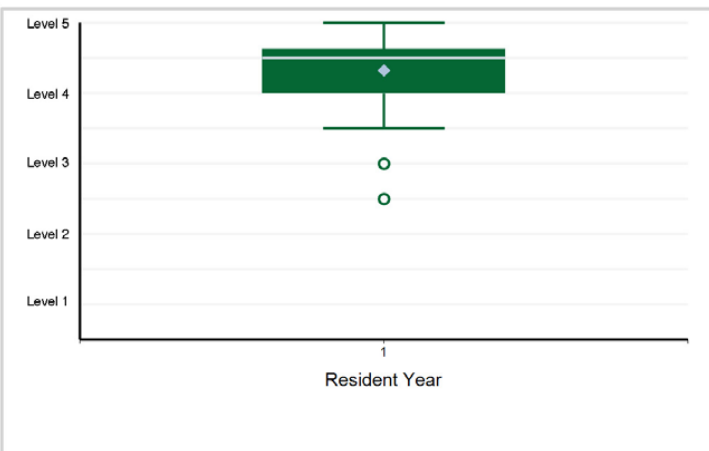

24. Interpersonal and Communication Skills - Interpersonal and Communication Skills 2: Interprofessional and Team Communication

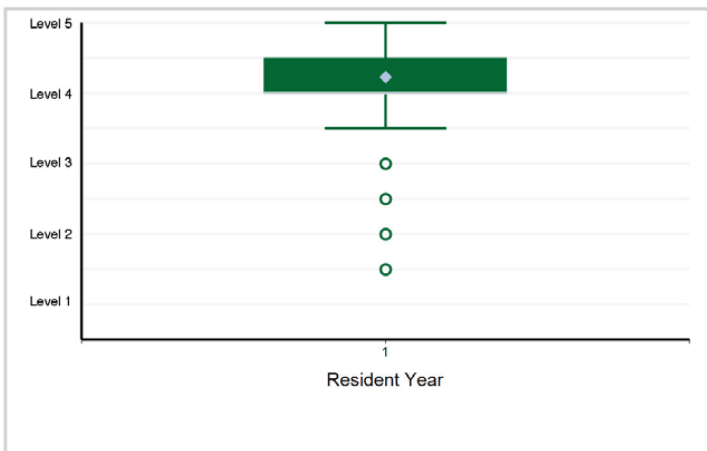

Specialty Box Plot Report - Milestone Evaluation by Resident Year: Year-End 2021-2022

SUBSPECIALTY: **Surgical Critical Care**

25. Interpersonal and Communication Skills - Interpersonal and Communication Skills 3: Communication within Health Care Systems



Specialty Box Plot Report - Milestone Evaluation by Resident Year: Year-End 2021-2022

TABLE 143: SUBSPECIALTY: **Vascular Surgery - Independent**

Resident Year	1	2	Total Residents
# of Residents	138	129	267

1. Patient Care - Patient Care 1: Patient Data

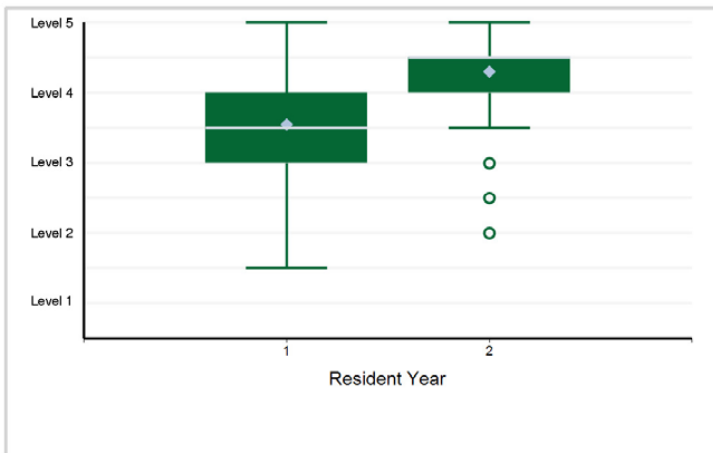

2. Patient Care - Patient Care 2: Medical Management of Vascular Disease

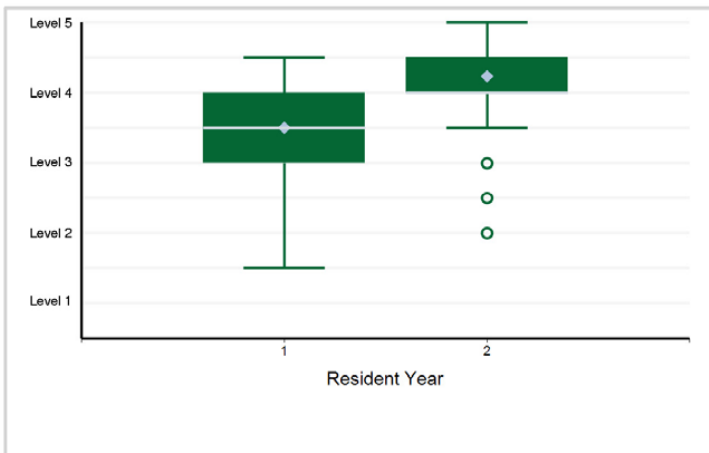

3. Patient Care - Patient Care 3: Peri-Operative Care

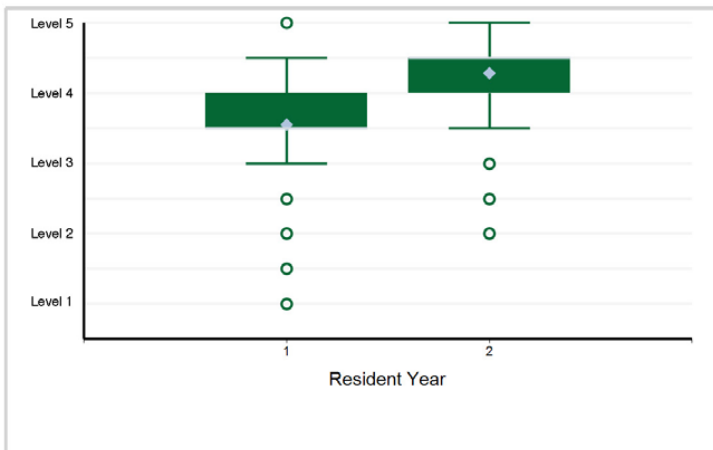

4. Patient Care - Patient Care 4: Longitudinal Care (e.g., Outpatient Management, Screening, Surveillance)

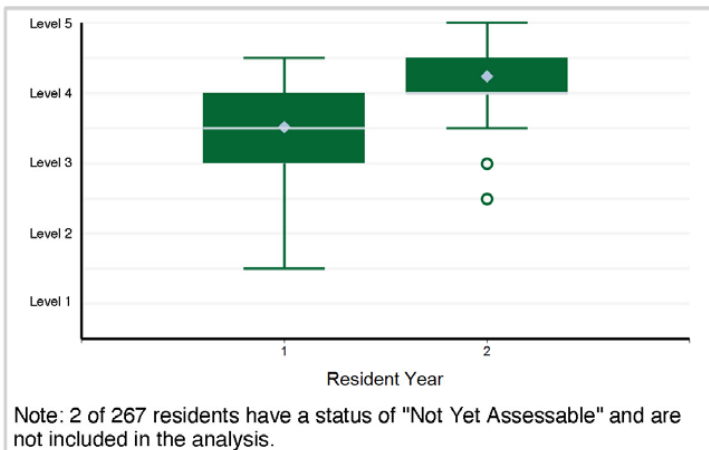

Note: 2 of 267 residents have a status of "Not Yet Assessable" and are not included in the analysis.

5. Patient Care - Patient Care 5: Procedural Preparation

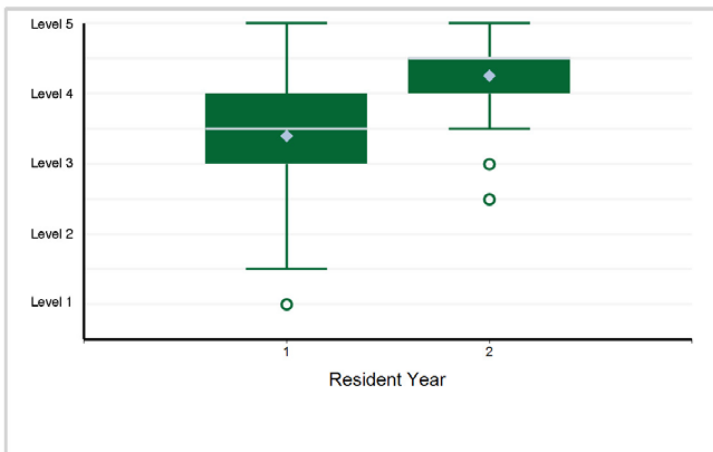

6. Patient Care - Patient Care 6: Technical Skills – Open Surgical Skills

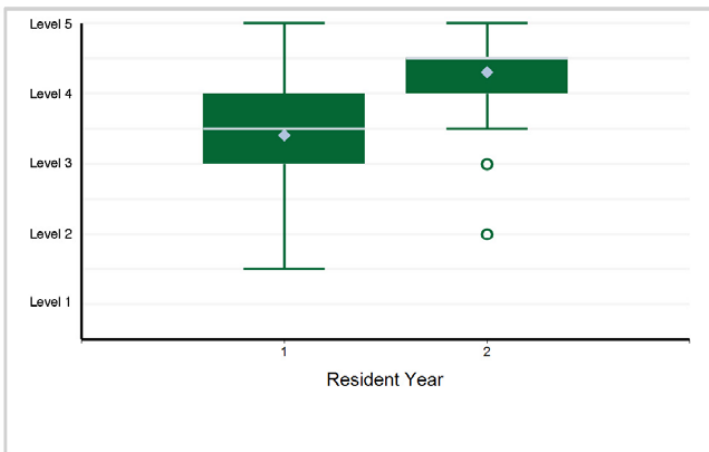

Specialty Box Plot Report - Milestone Evaluation by Resident Year: Year-End 2021-2022

SUBSPECIALTY: Vascular Surgery - Independent

7. Patient Care - Patient Care 7: Technical Skills – Endovascular

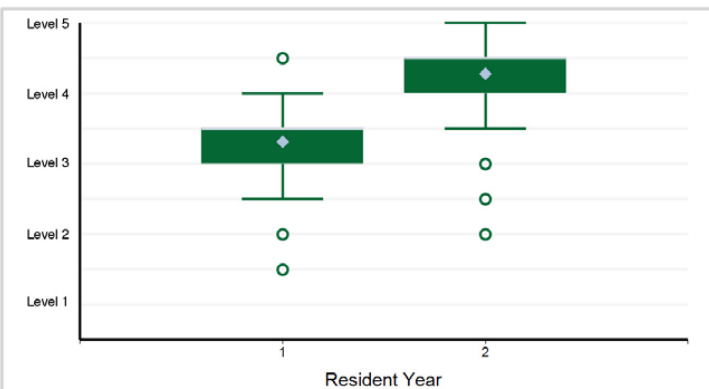

Note: 1 of 267 residents have a status of "Not Yet Assessable" and are not included in the analysis.

8. Patient Care - Patient Care 8: Vascular Imaging (e.g., Computed Tomography [CT], Magnetic Resonance [MR], Angiography, Ultrasonography)

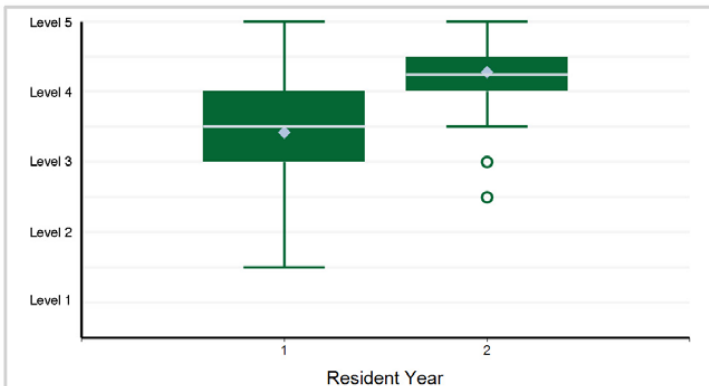

Note: 1 of 267 residents have a status of "Not Yet Assessable" and are not included in the analysis.

9. Medical Knowledge - Medical Knowledge 1: Procedural Rationale (Open Surgical Procedures)

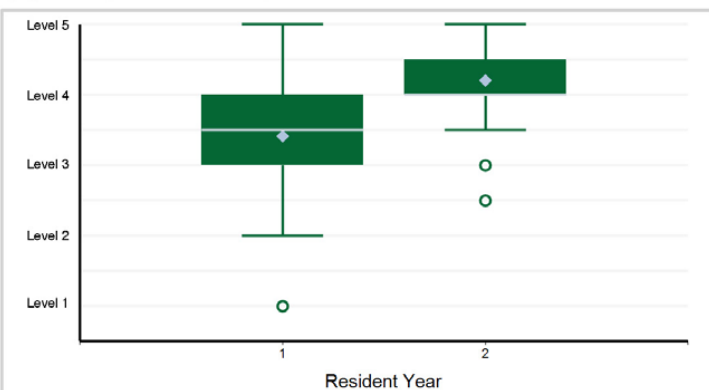

10. Medical Knowledge - Medical Knowledge 2: Procedural Rationale (Endovascular Interventions)

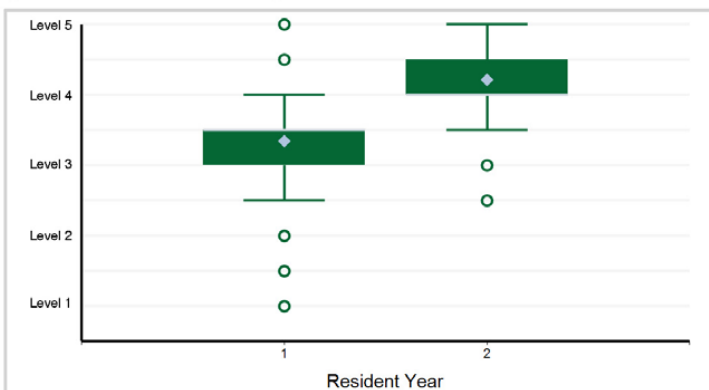

11. Medical Knowledge - Medical Knowledge 3: Procedural Understanding, including Anatomy (Open Surgical Procedures)

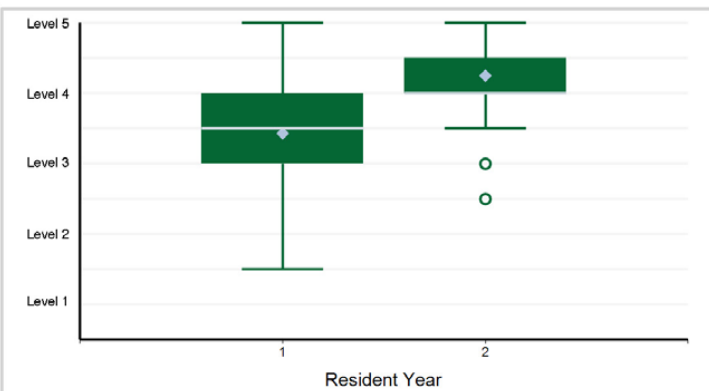

12. Medical Knowledge - Medical Knowledge 4: Procedural Understanding, including Anatomy (Endovascular Procedures)

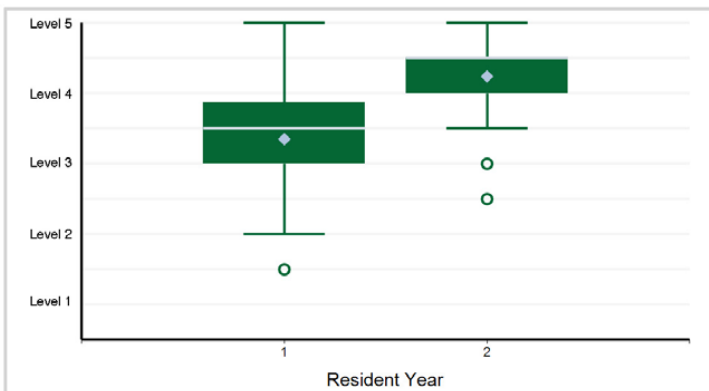

Specialty Box Plot Report - Milestone Evaluation by Resident Year: Year-End 2021-2022

SUBSPECIALTY: Vascular Surgery - Independent

13. Medical Knowledge - Medical Knowledge 5: Intra-Operative Crisis Management

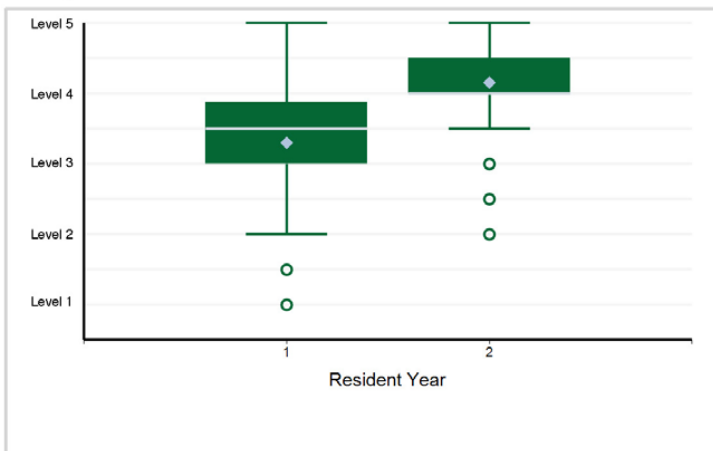

14. Systems-Based Practice - Systems-Based Practice 1: Patient Safety

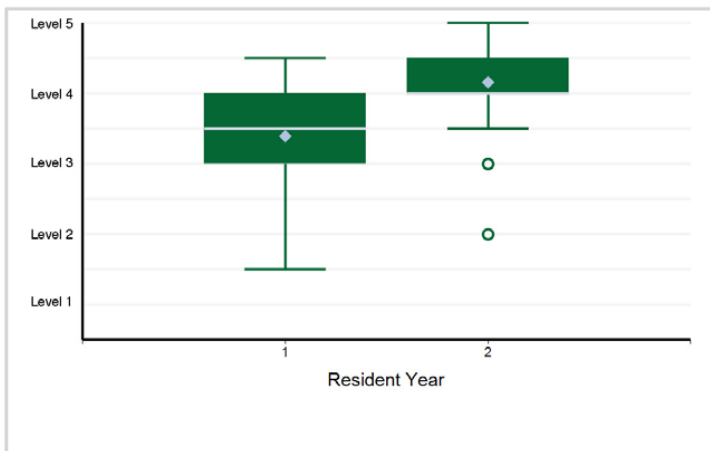

15. Systems-Based Practice - Systems-Based Practice 2: Quality Improvement

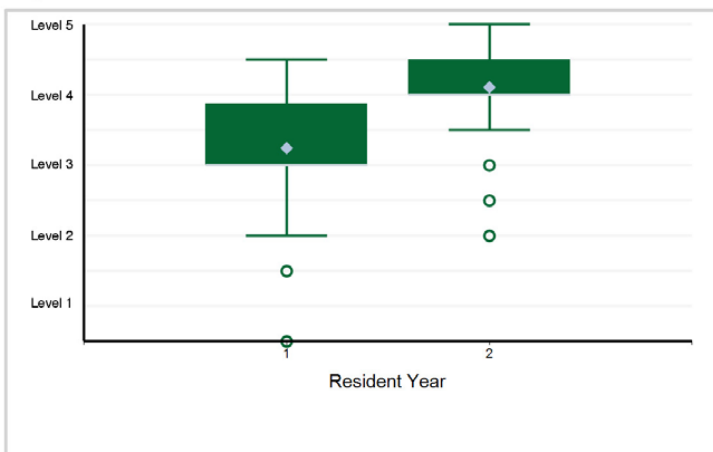

16. Systems-Based Practice - Systems-Based Practice 3: System Navigation for Patient-Centered Care

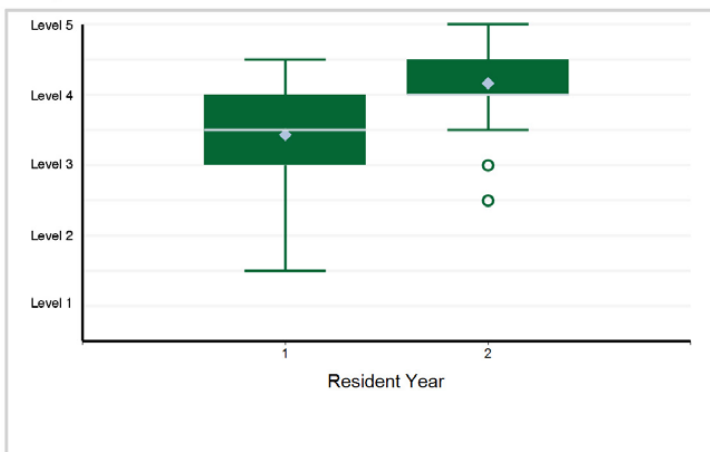

17. Systems-Based Practice - Systems-Based Practice 4: Population Health

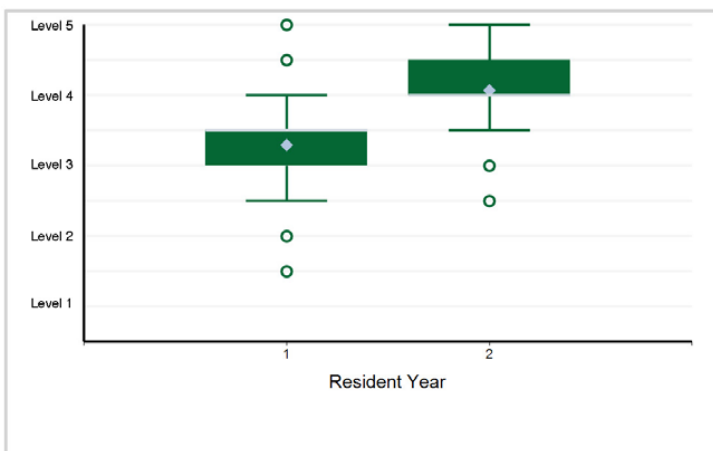

18. Systems-Based Practice - Systems-Based Practice 5: Physician Role in Health Care Systems

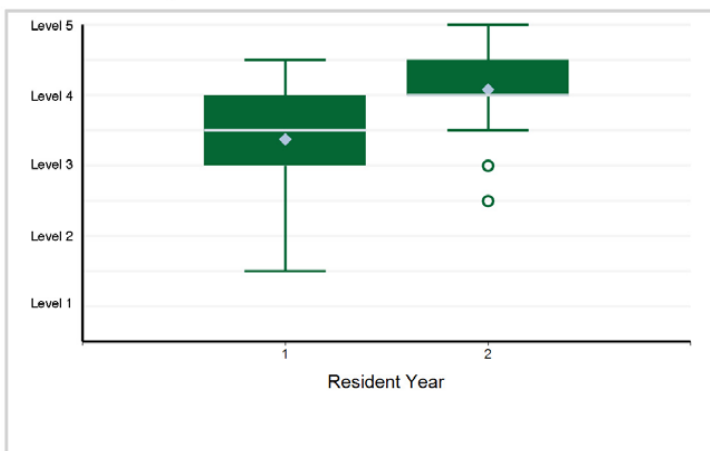

Specialty Box Plot Report - Milestone Evaluation by Resident Year: Year-End 2021-2022

SUBSPECIALTY: Vascular Surgery - Independent

19. Systems-Based Practice - Systems-Based Practice 6: Radiation Safety

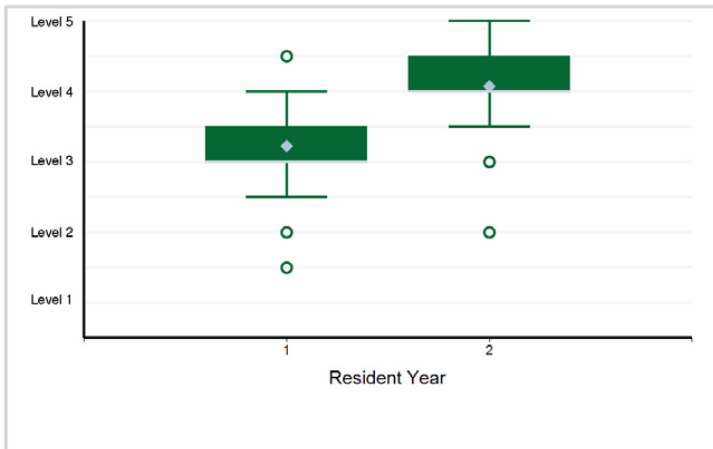

20. Practice-Based Learning and Improvement - Practice-Based Learning and Improvement 1: Evidence-Based and Informed Practice

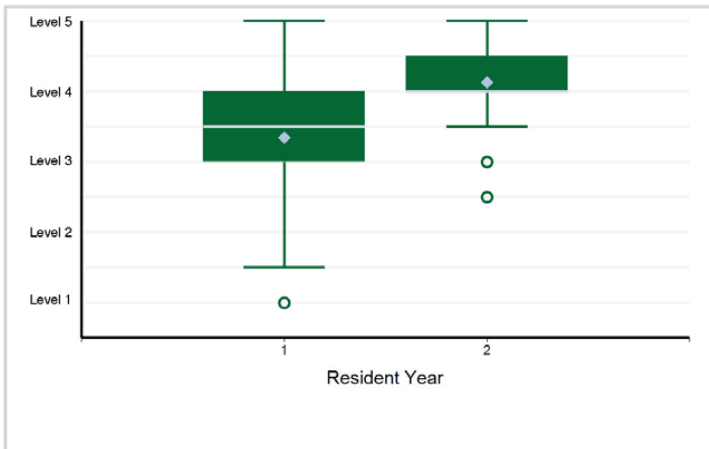

21. Practice-Based Learning and Improvement - Practice-Based Learning and Improvement 2: Reflective Practice and Commitment ...

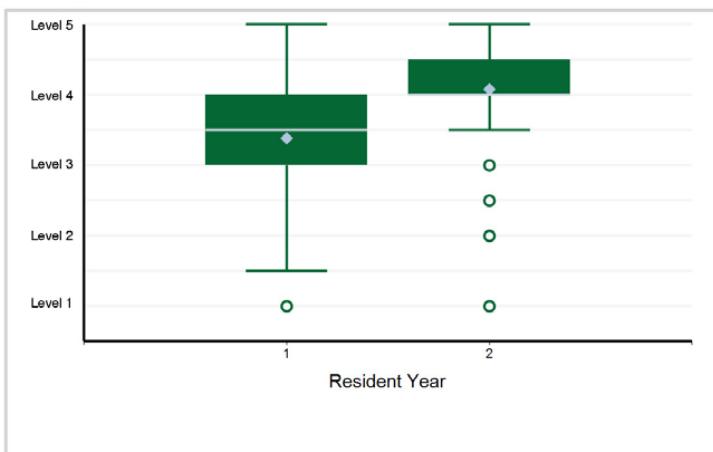

22. Professionalism - Professionalism 1: Professional Behavior

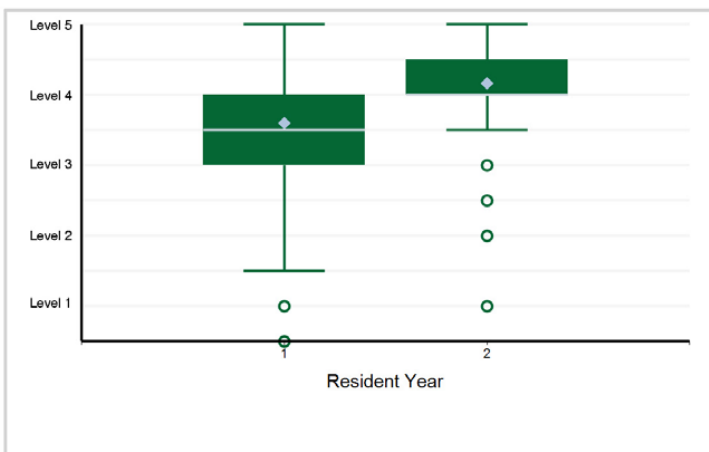

23. Professionalism - Professionalism 2: Ethical Principles

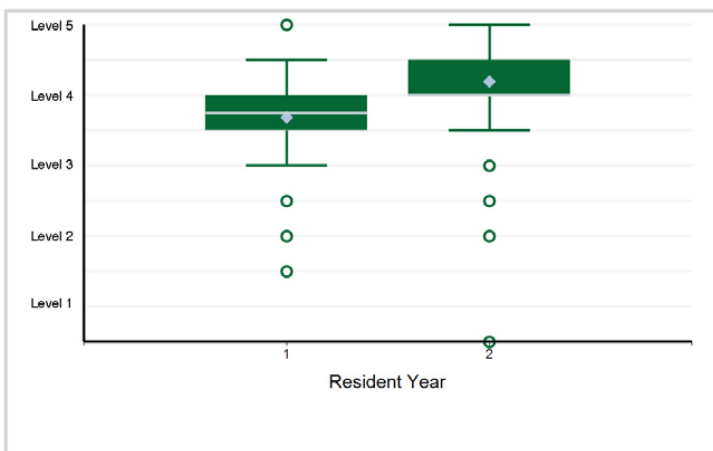

24. Professionalism - Professionalism 3: Accountability/Conscientiousness

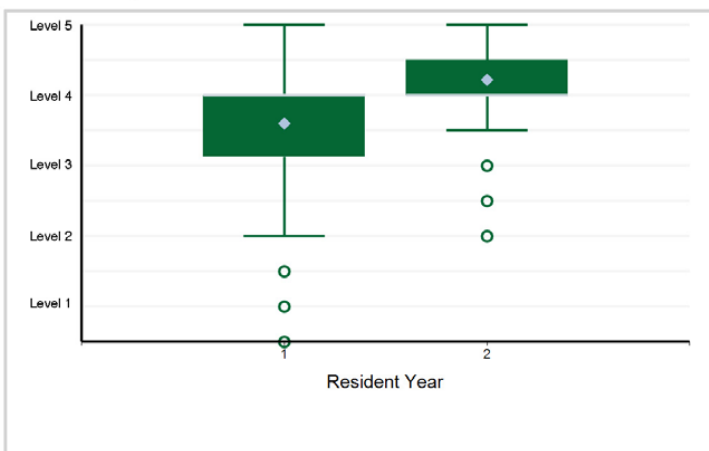

Specialty Box Plot Report - Milestone Evaluation by Resident Year: Year-End 2021-2022

SUBSPECIALTY: Vascular Surgery - Independent

25. Professionalism - Professionalism 4: Self-Awareness and Help-Seeking

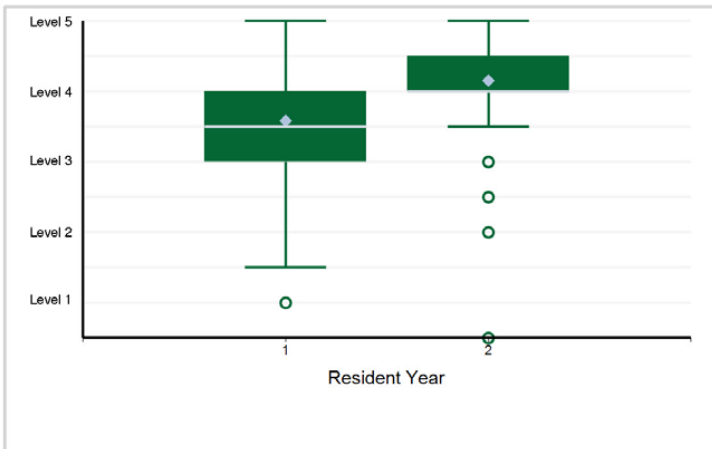

26. Interpersonal and Communication Skills - Interpersonal and Communication Skills 1: Patient- and Family-Centered Communication

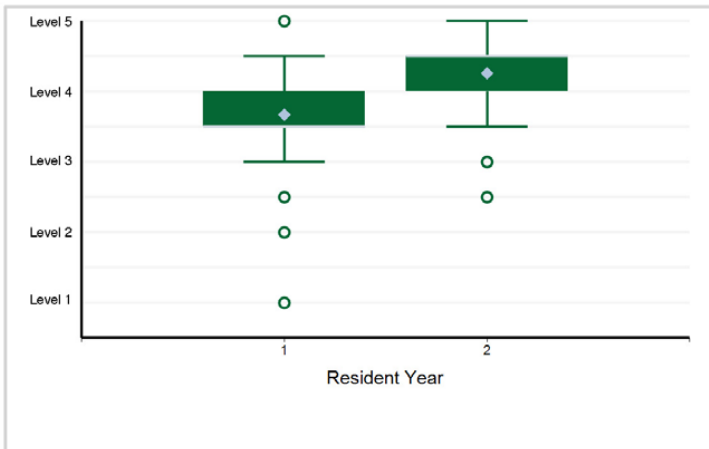

27. Interpersonal and Communication Skills - Interpersonal and Communication Skills 2: Interprofessional and Team Communication

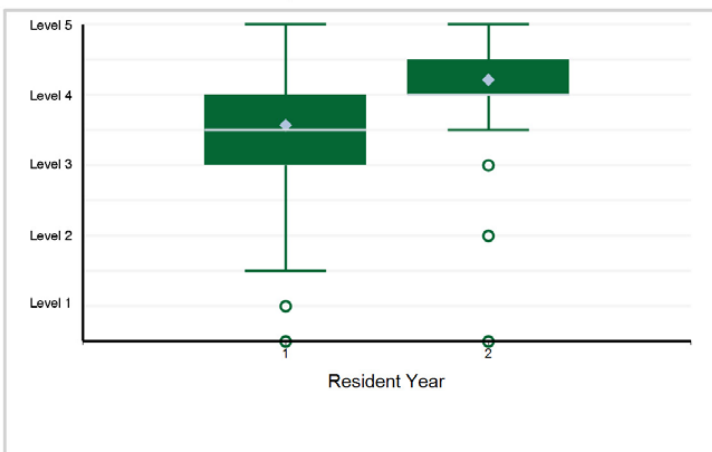

28. Interpersonal and Communication Skills - Interpersonal and Communication Skills 3: Communication within Health Care Systems

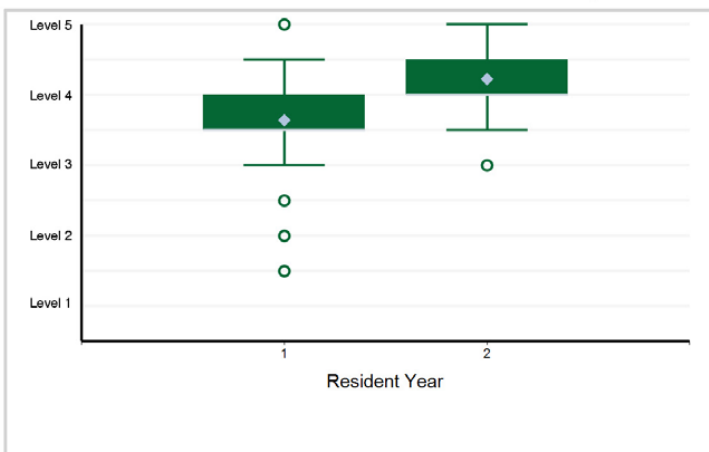

Specialty Box Plot Report - Milestone Evaluation by Resident Year: Year-End 2021-2022

TABLE 144: SPECIALTY: **Vascular Surgery - Integrated**

Resident Year	1	2	3	4	5	Total Residents
# of Residents	81	81	71	66	64	363

1. Patient Care - Patient Care 1: Patient Data

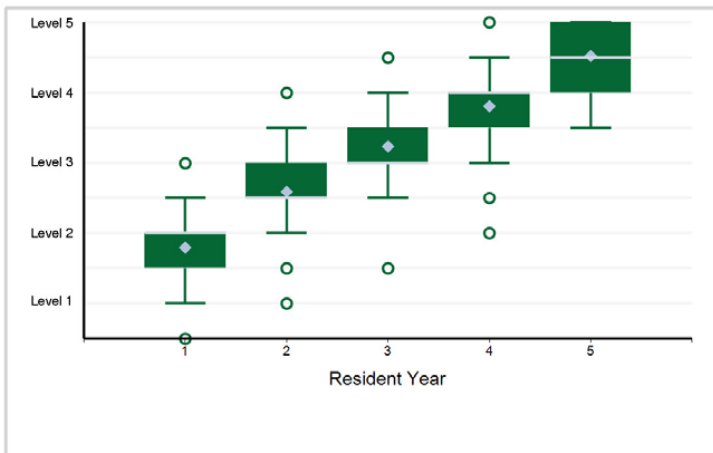

2. Patient Care - Patient Care 2: Medical Management of Vascular Disease

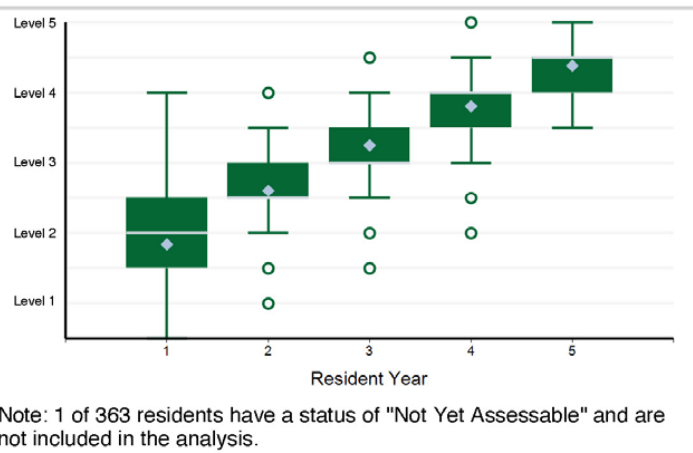

Note: 1 of 363 residents have a status of "Not Yet Assessable" and are not included in the analysis.

3. Patient Care - Patient Care 3: Peri-Operative Care

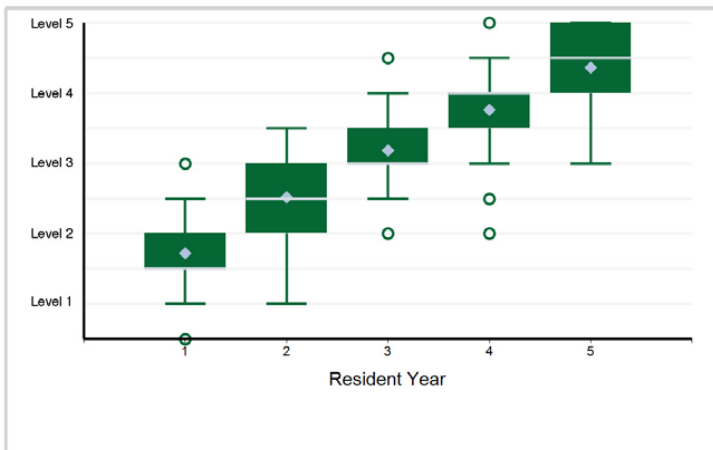

4. Patient Care - Patient Care 4: Longitudinal Care (e.g., Outpatient Management, Screening, Surveillance)

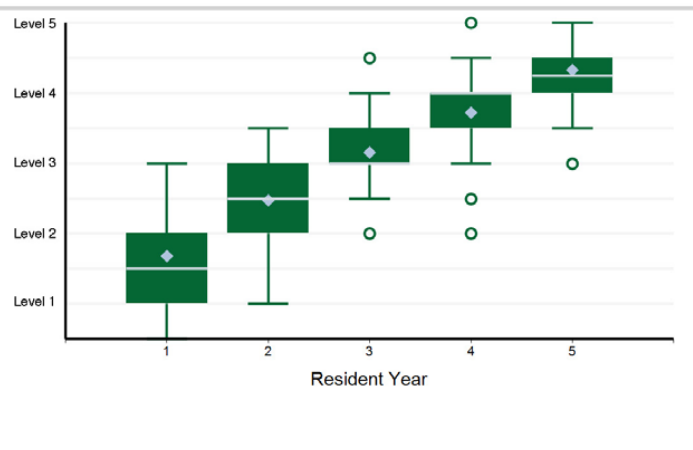

5. Patient Care - Patient Care 5: Procedural Preparation

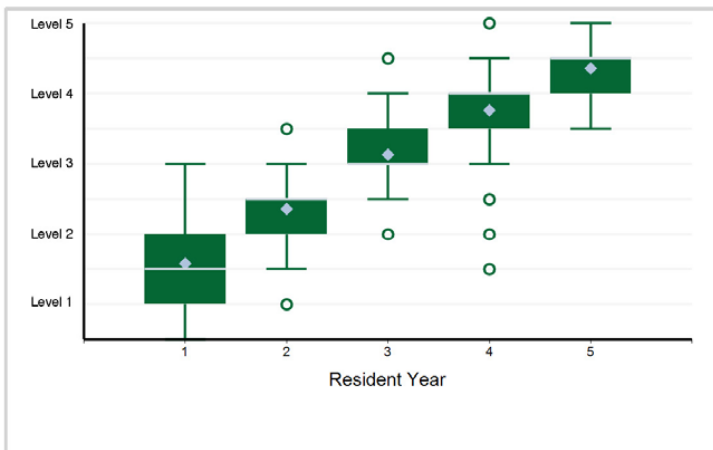

6. Patient Care - Patient Care 6: Technical Skills – Open Surgical Skills

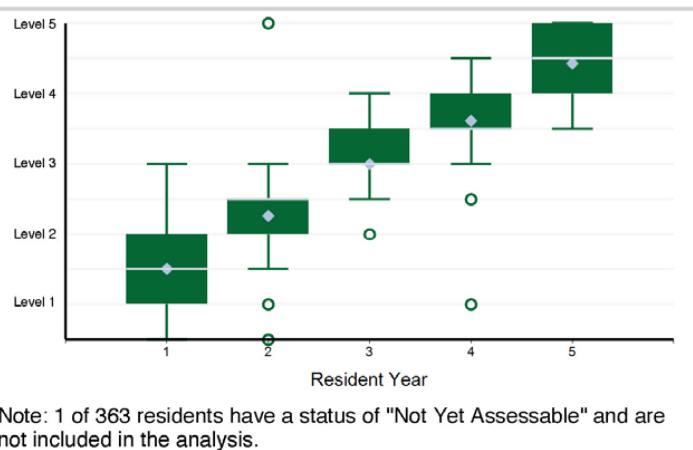

Note: 1 of 363 residents have a status of "Not Yet Assessable" and are not included in the analysis.

Specialty Box Plot Report - Milestone Evaluation by Resident Year: Year-End 2021-2022

SPECIALTY: Vascular Surgery - Integrated

7. Patient Care - Patient Care 7: Technical Skills – Endovascular

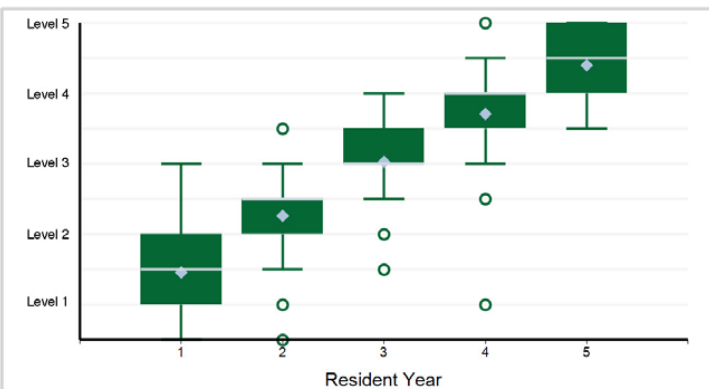

Note: 6 of 363 residents have a status of "Not Yet Assessable" and are not included in the analysis.

8. Patient Care - Patient Care 8: Vascular Imaging (e.g., Computed Tomography [CT], Magnetic Resonance [MR], Angiography, Ultrasonography)

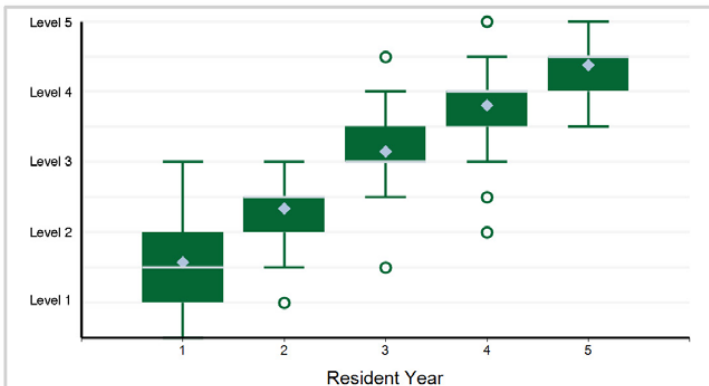

9. Medical Knowledge - Medical Knowledge 1: Procedural Rationale (Open Surgical Procedures)

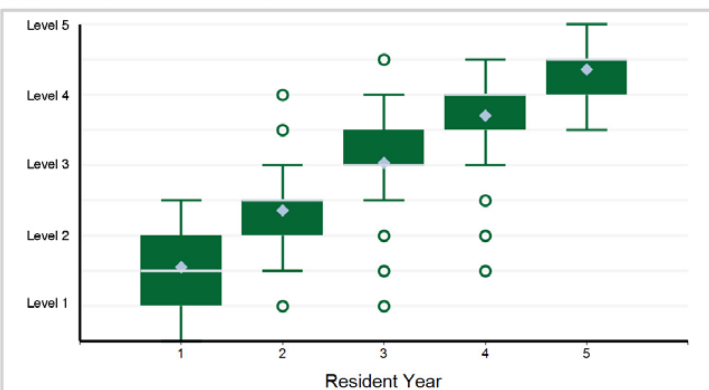

10. Medical Knowledge - Medical Knowledge 2: Procedural Rationale (Endovascular Interventions)

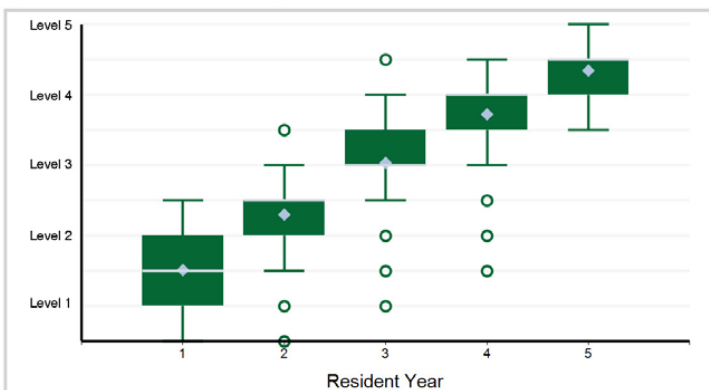

Note: 2 of 363 residents have a status of "Not Yet Assessable" and are not included in the analysis.

11. Medical Knowledge - Medical Knowledge 3: Procedural Understanding, including Anatomy (Open Surgical Procedures)

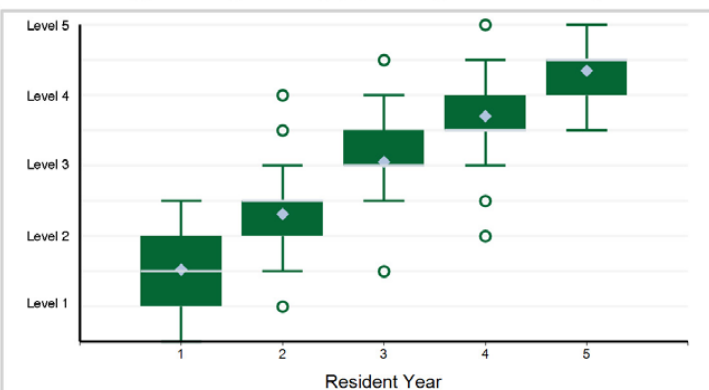

Note: 2 of 363 residents have a status of "Not Yet Assessable" and are not included in the analysis.

12. Medical Knowledge - Medical Knowledge 4: Procedural Understanding, including Anatomy (Endovascular Procedures)

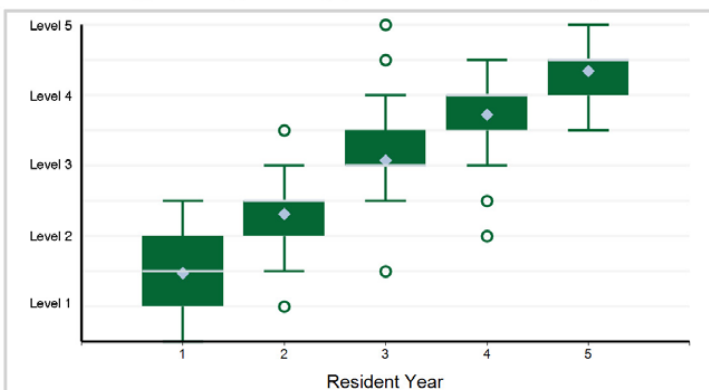

Note: 3 of 363 residents have a status of "Not Yet Assessable" and are not included in the analysis.

Specialty Box Plot Report - Milestone Evaluation by Resident Year: Year-End 2021-2022

SPECIALTY: Vascular Surgery - Integrated

13. Medical Knowledge - Medical Knowledge 5: Intra-Operative Crisis Management

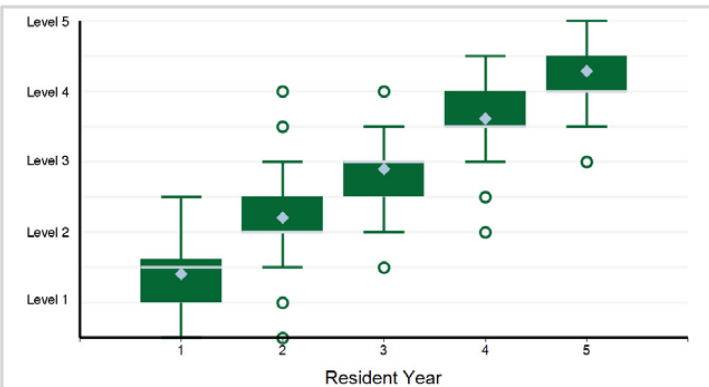

Note: 5 of 363 residents have a status of "Not Yet Assessable" and are not included in the analysis.

14. Systems-Based Practice - Systems-Based Practice 1: Patient Safety

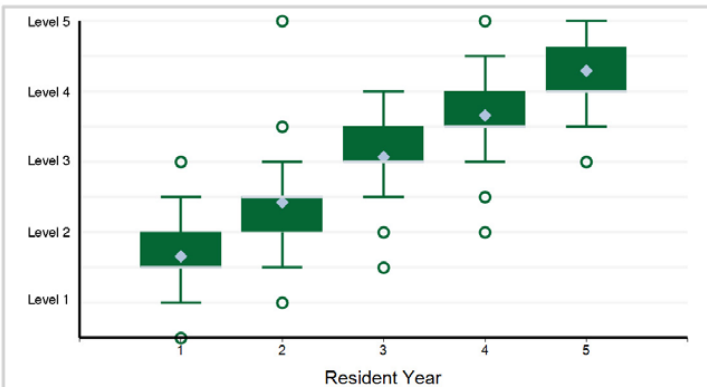

15. Systems-Based Practice - Systems-Based Practice 2: Quality Improvement

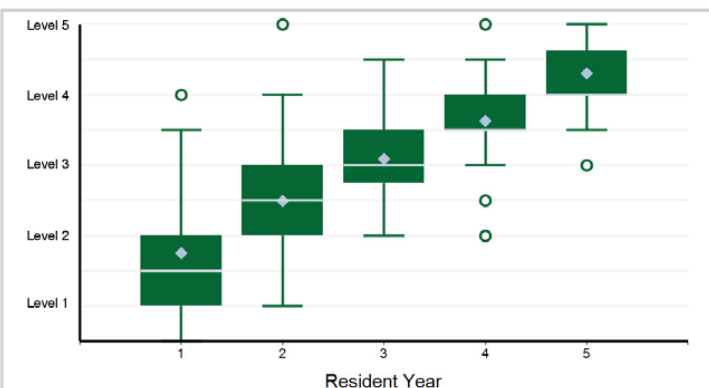

16. Systems-Based Practice - Systems-Based Practice 3: System Navigation for Patient-Centered Care

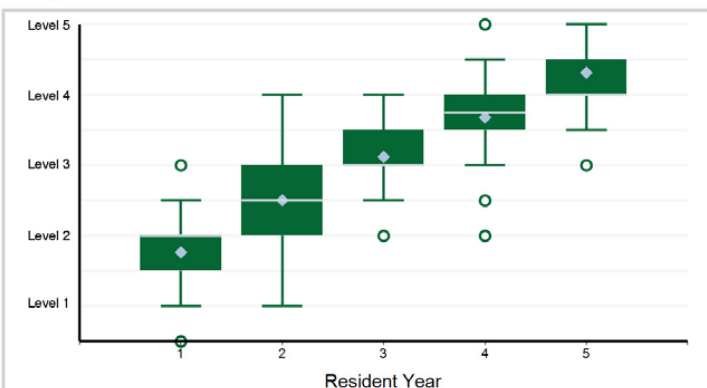

17. Systems-Based Practice - Systems-Based Practice 4: Population Health

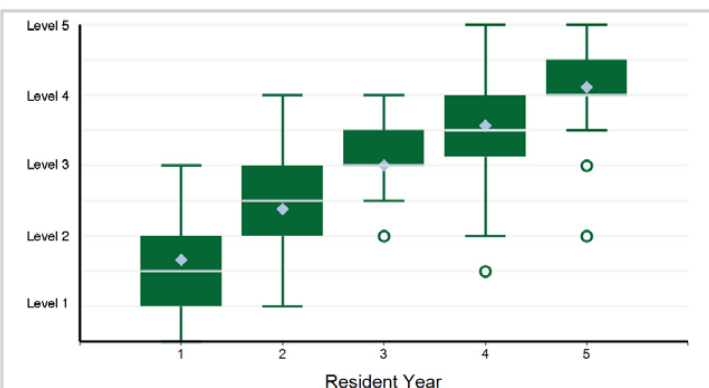

18. Systems-Based Practice - Systems-Based Practice 5: Physician Role in Health Care Systems

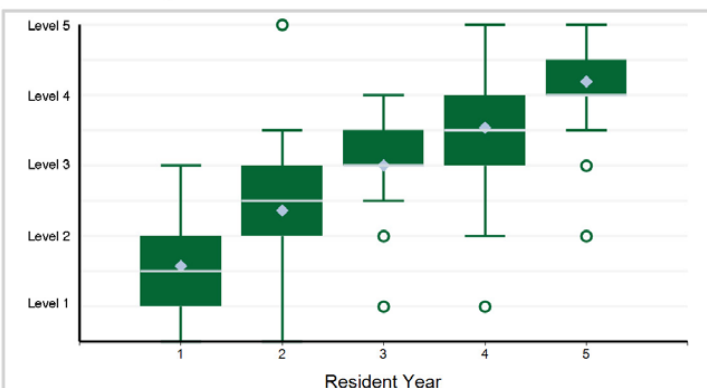

Specialty Box Plot Report - Milestone Evaluation by Resident Year: Year-End 2021-2022

SPECIALTY: Vascular Surgery - Integrated

19. Systems-Based Practice - Systems-Based Practice 6: Radiation Safety

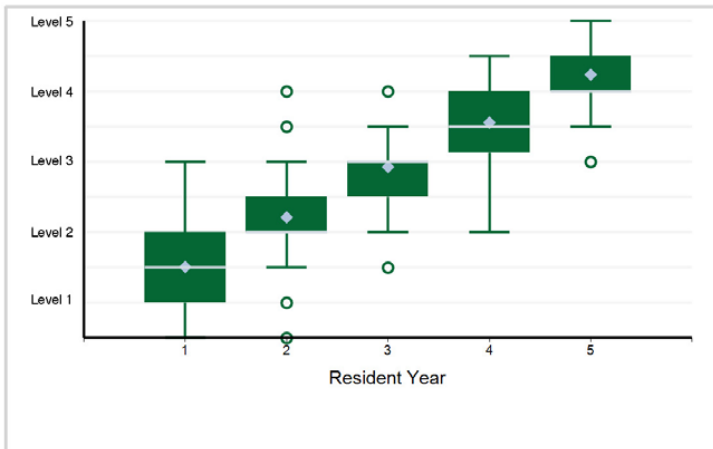

20. Practice-Based Learning and Improvement - Practice-Based Learning and Improvement 1: Evidence-Based and Informed Practice

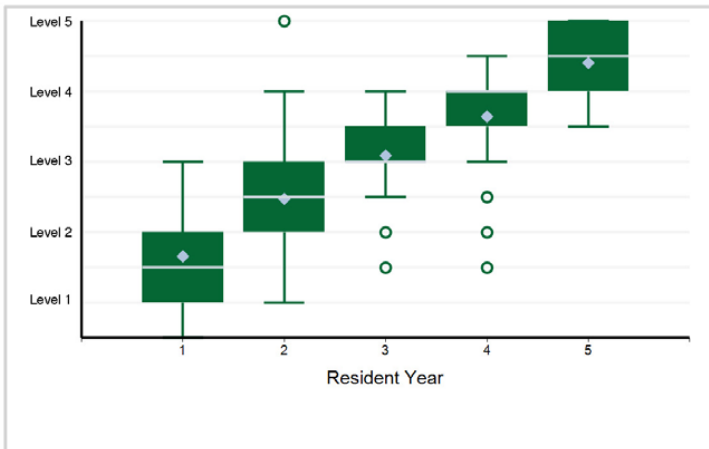

21. Practice-Based Learning and Improvement - Practice-Based Learning and Improvement 2: Reflective Practice and Commitment ...

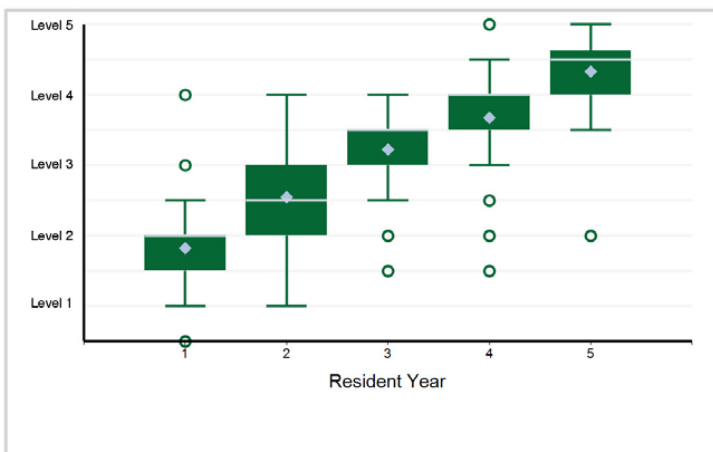

22. Professionalism - Professionalism 1: Professional Behavior

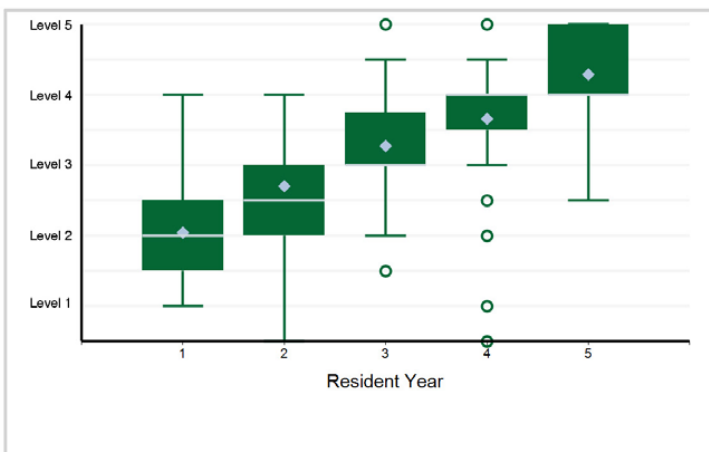

23. Professionalism - Professionalism 2: Ethical Principles

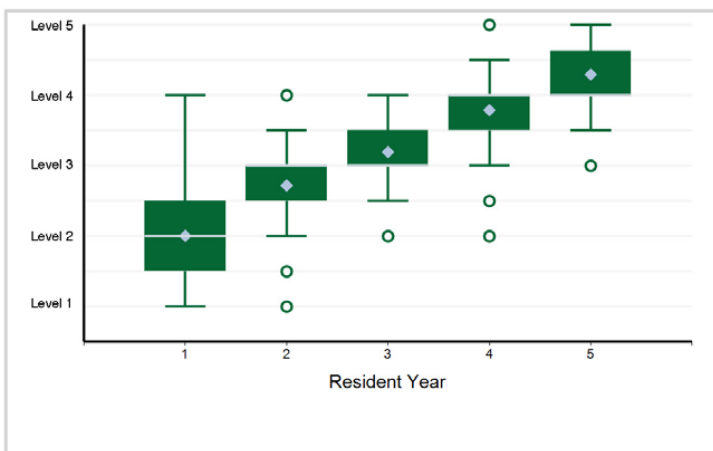

24. Professionalism - Professionalism 3: Accountability/Conscientiousness

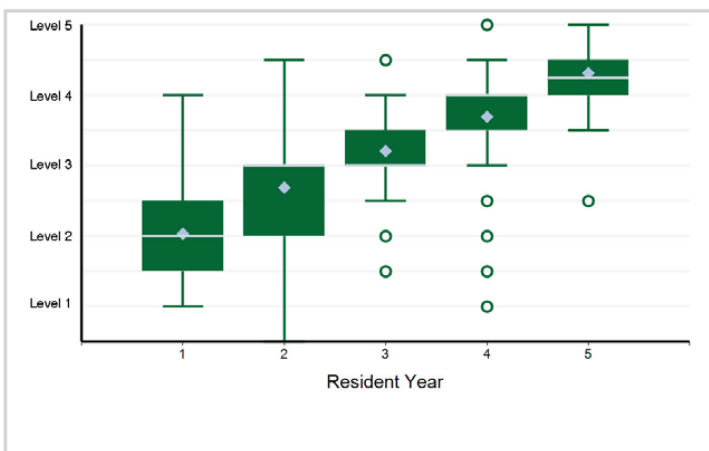

Specialty Box Plot Report - Milestone Evaluation by Resident Year: Year-End 2021-2022

SPECIALTY: Vascular Surgery - Integrated

25. Professionalism - Professionalism 4: Self-Awareness and Help-Seeking

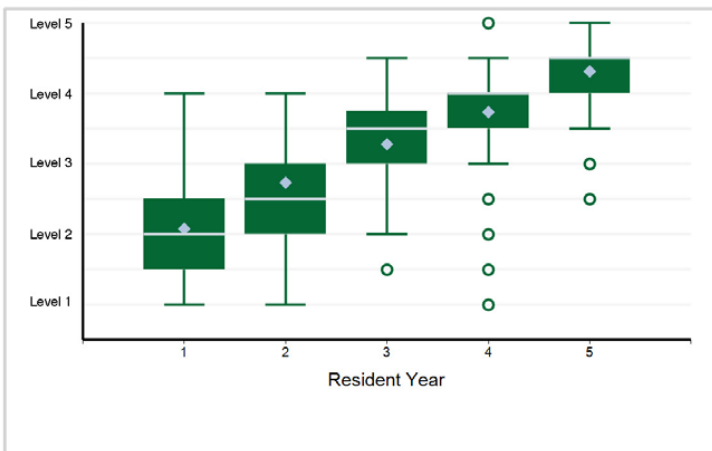

26. Interpersonal and Communication Skills - Interpersonal and Communication Skills 1: Patient- and Family-Centered Communication

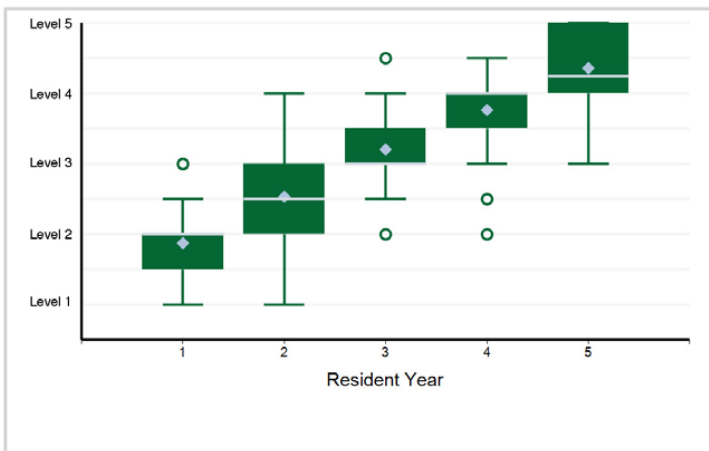

27. Interpersonal and Communication Skills - Interpersonal and Communication Skills 2: Interprofessional and Team Communication

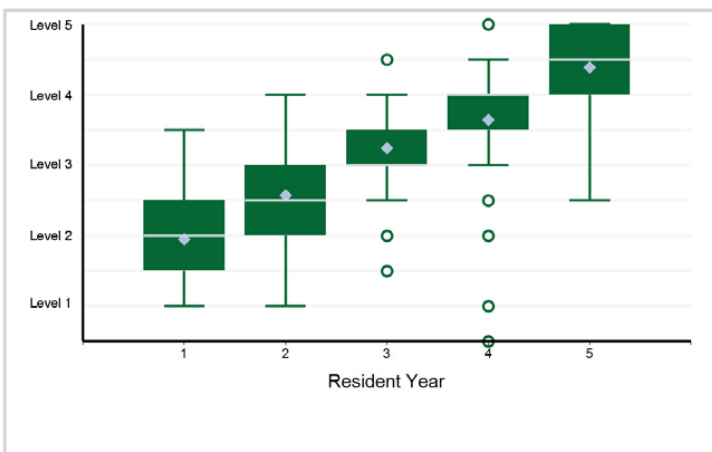

28. Interpersonal and Communication Skills - Interpersonal and Communication Skills 3: Communication within Health Care Systems

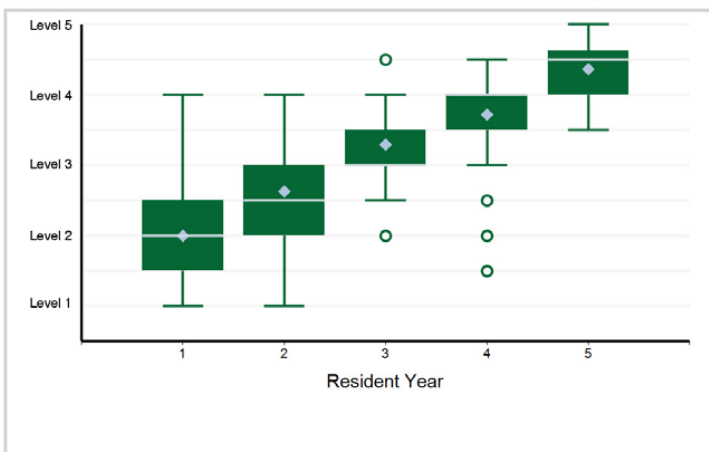

Specialty Box Plot Report - Milestone Evaluation by Resident Year: Year-End 2021-2022

TABLE 145: SPECIALTY: **Thoracic Surgery - Independent (Two-Year Program)**

Resident Year	1	2	Total Residents
# of Residents	78	73	151

1. Patient Care - Patient Care 1: Ischemic Heart Disease

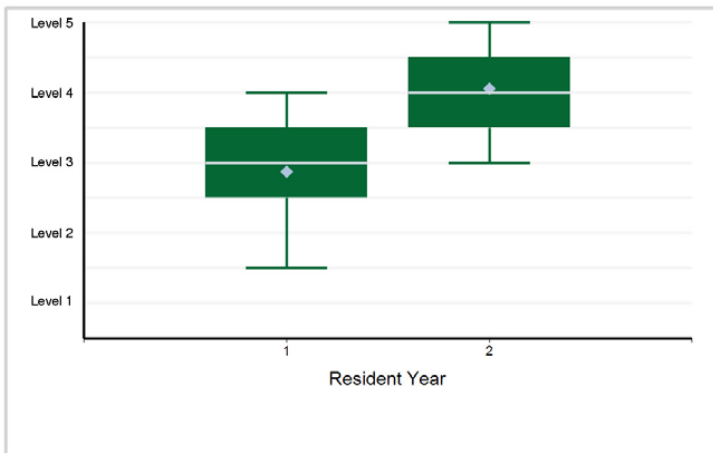

2. Patient Care - Patient Care 2: Mechanical Circulatory Support

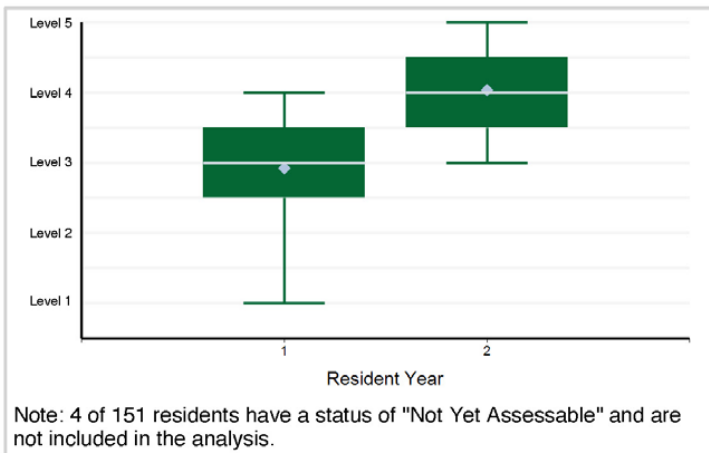

3. Patient Care - Patient Care 3: Valvular Disease

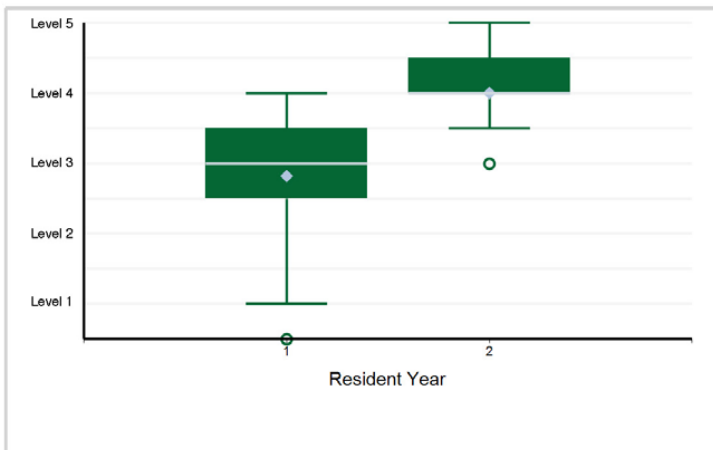

4. Patient Care - Patient Care 4: Great Vessel Disease

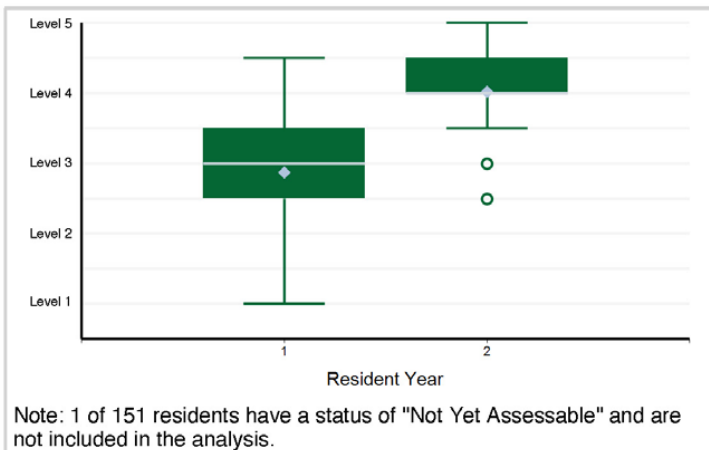

5. Patient Care - Patient Care 5: Esophagus

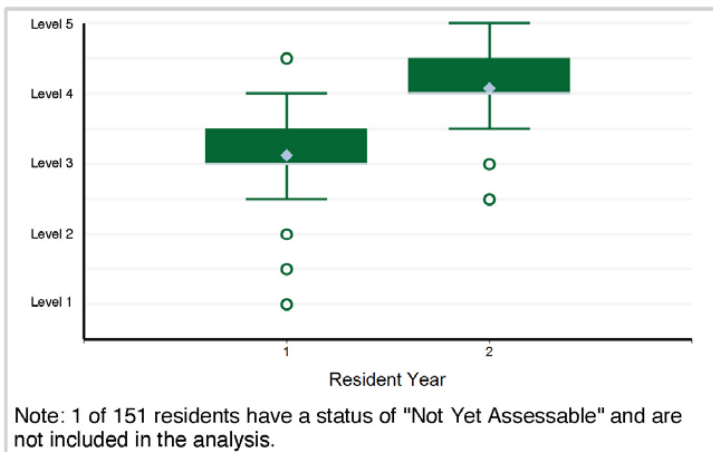

6. Patient Care - Patient Care 6: Lung and Airway

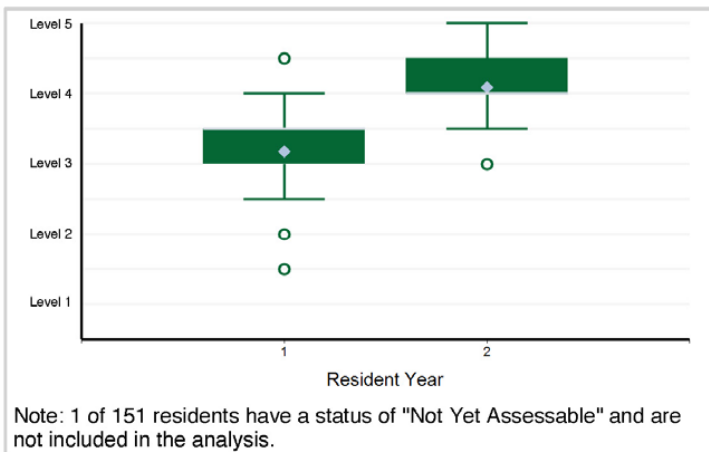

Specialty Box Plot Report - Milestone Evaluation by Resident Year: Year-End 2021-2022

SPECIALTY: Thoracic Surgery - Independent (Two-Year Program)

7. Patient Care - Patient Care 7: Chest Wall/Pleura/Mediastinum/Diaphragm

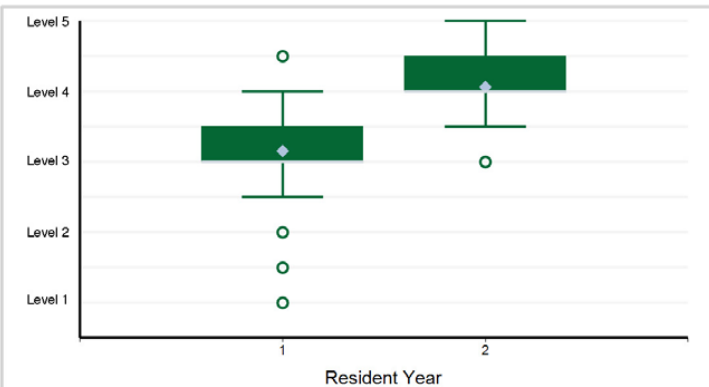

Note: 2 of 151 residents have a status of "Not Yet Assessable" and are not included in the analysis.

8. Patient Care - Patient Care 8: Critical Care

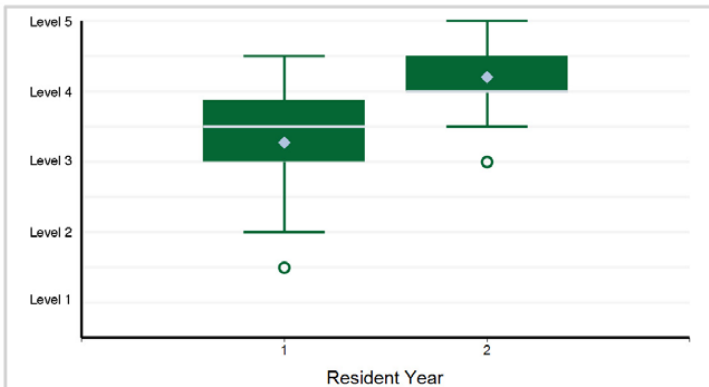

Note: 3 of 151 residents have a status of "Not Yet Assessable" and are not included in the analysis.

9. Medical Knowledge - Medical Knowledge 1: Cardiovascular Surgical Knowledge

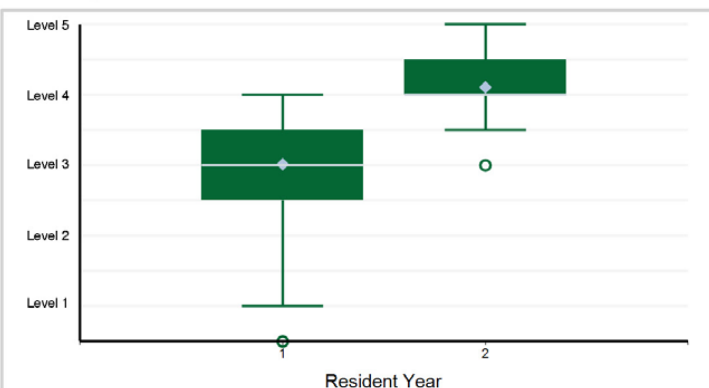

10. Medical Knowledge - Medical Knowledge 2: General Thoracic Surgical Knowledge

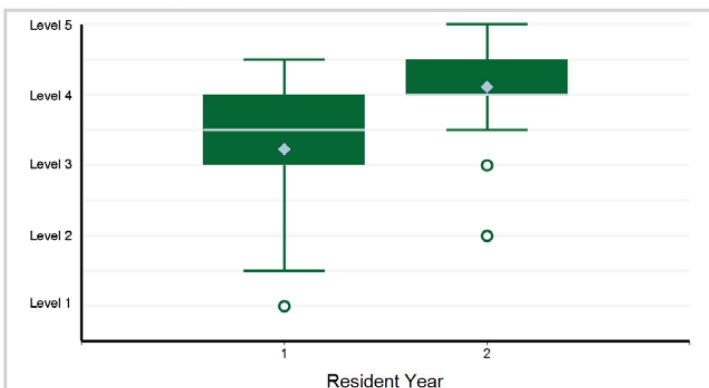

11. Medical Knowledge - Medical Knowledge 3: Congenital Heart Disease

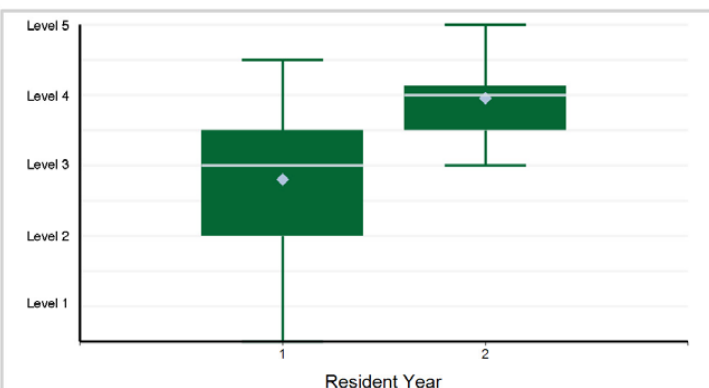

Note: 12 of 151 residents have a status of "Not Yet Assessable" and are not included in the analysis.

12. Systems-Based Practice - Systems-Based Practice 1: Patient Safety and Quality Improvement

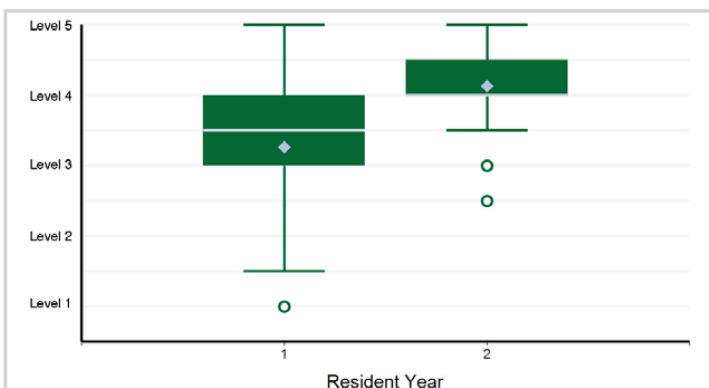

Specialty Box Plot Report - Milestone Evaluation by Resident Year: Year-End 2021-2022

SPECIALTY: Thoracic Surgery - Independent (Two-Year Program)

13. Systems-Based Practice - Systems-Based Practice 2: System Navigation for Patient-Centered Care

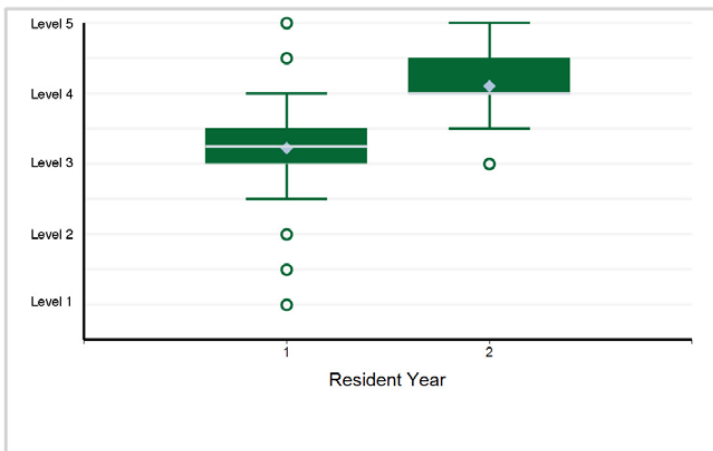

14. Systems-Based Practice - Systems-Based Practice 3: Physician Role in Health Care Systems

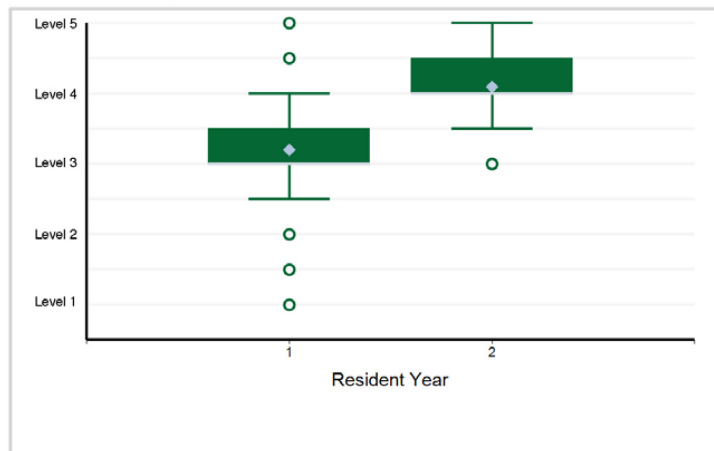

15. Practice-Based Learning and Improvement - Practice-Based Learning and Improvement 1: Evidence-Based and Informed Practice

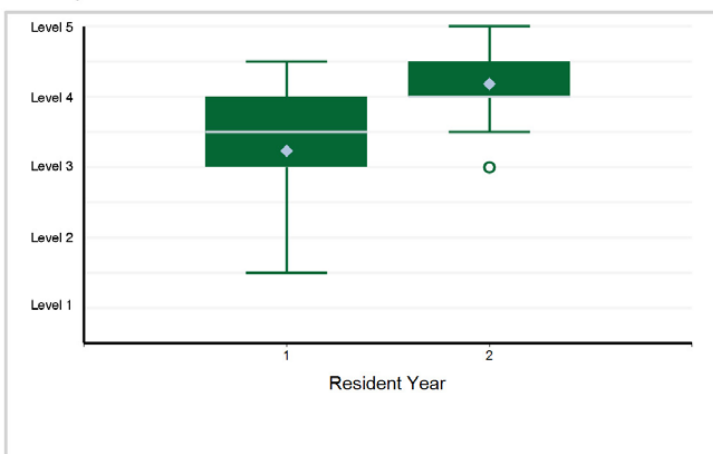

16. Practice-Based Learning and Improvement - Practice-Based Learning and Improvement 2: Reflective Practice and Commitment ...

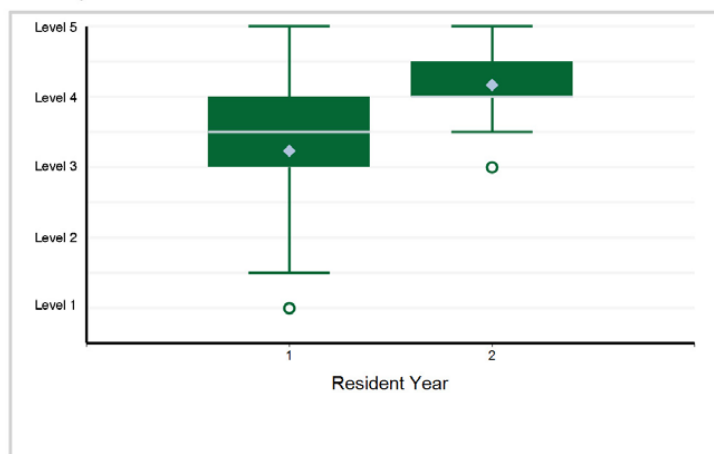

17. Professionalism - Professionalism 1: Ethical Principles

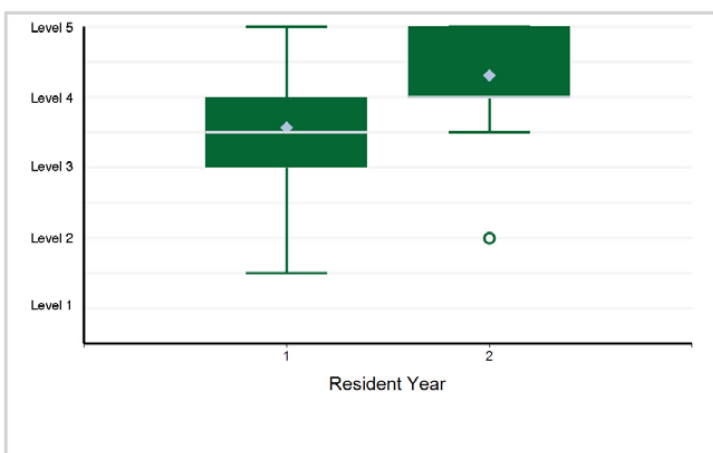

18. Professionalism - Professionalism 2: Professional Behavior and Accountability

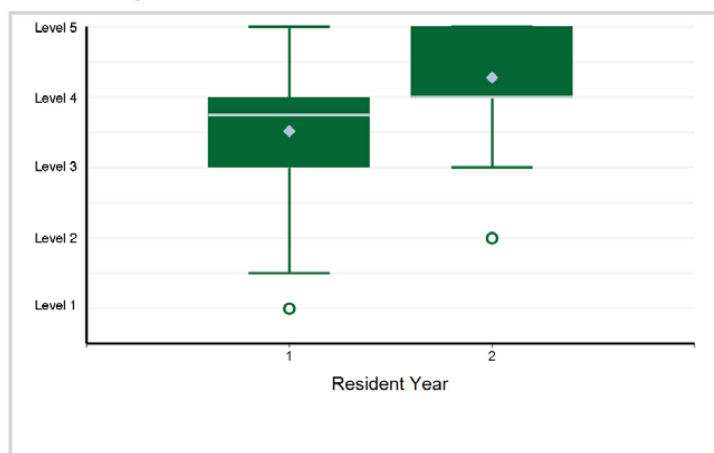

Specialty Box Plot Report - Milestone Evaluation by Resident Year: Year-End 2021-2022

SPECIALTY: Thoracic Surgery - Independent (Two-Year Program)

19. Professionalism - Professionalism 3: Administrative Tasks

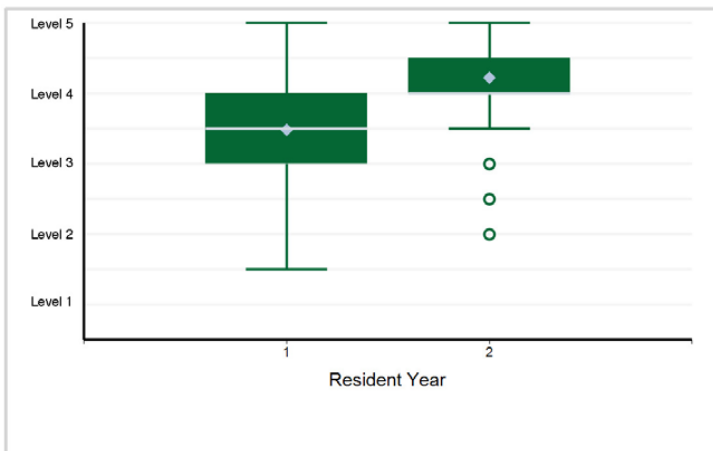

20. Professionalism - Professionalism 4: Well-Being

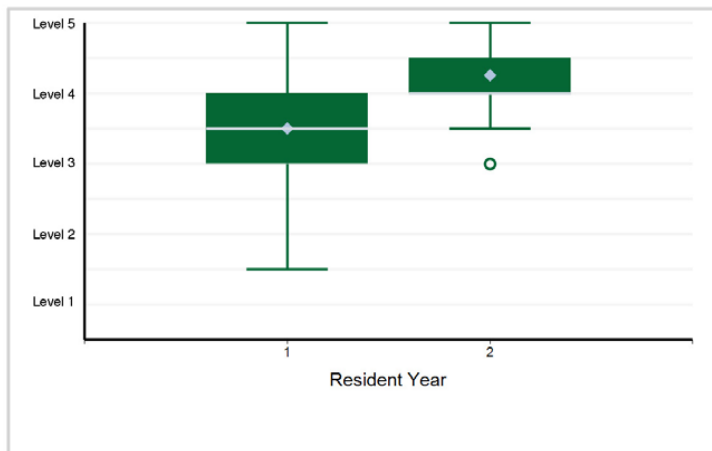

21. Interpersonal and Communication Skills - Interpersonal and Communication Skills 1: Patient- and Family-Centered Communication

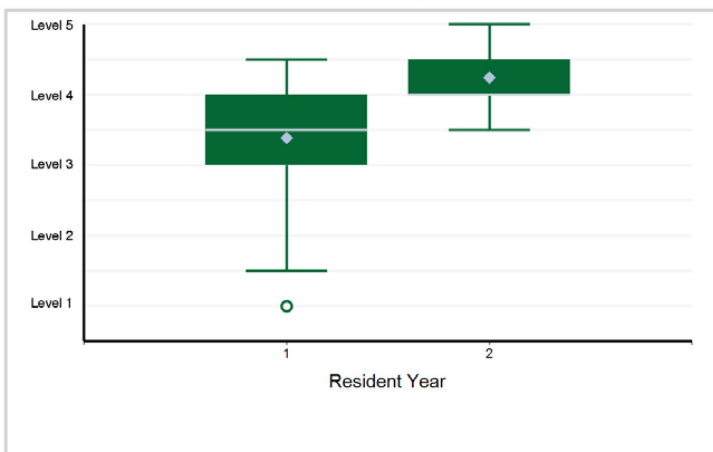

22. Interpersonal and Communication Skills - Interpersonal and Communication Skills 2: Interprofessional and Team Communication

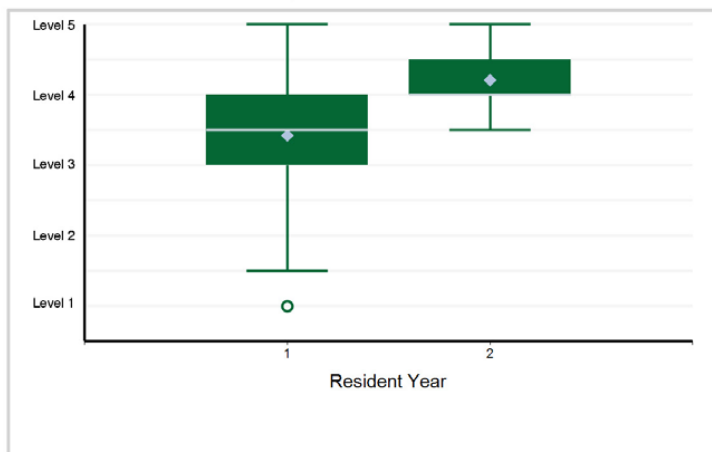

23. Interpersonal and Communication Skills - Interpersonal and Communication Skills 3: Communication within Health Care Systems

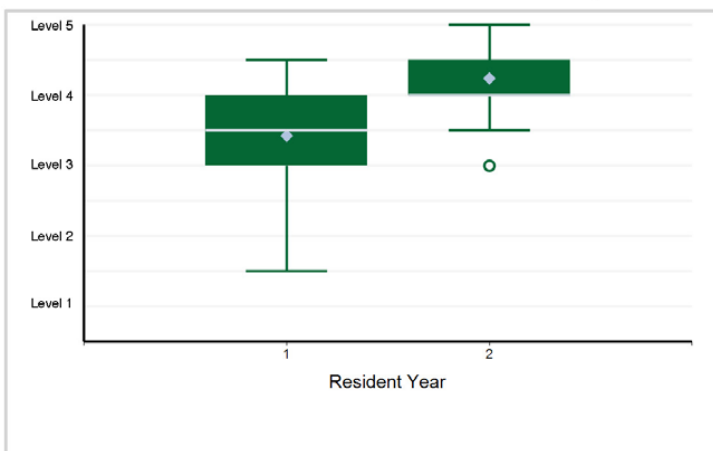

Specialty Box Plot Report - Milestone Evaluation by Resident Year: Year-End 2021-2022

SPECIALTY: Thoracic Surgery - Independent (Three-Year Program)

Resident Year	1	2	3	Total Residents
# of Residents	34	35	31	100

1. Patient Care - Patient Care 1: Ischemic Heart Disease

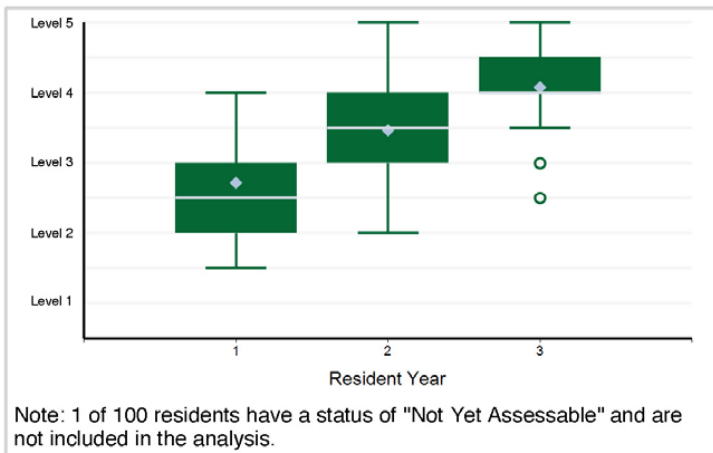

2. Patient Care - Patient Care 2: Mechanical Circulatory Support

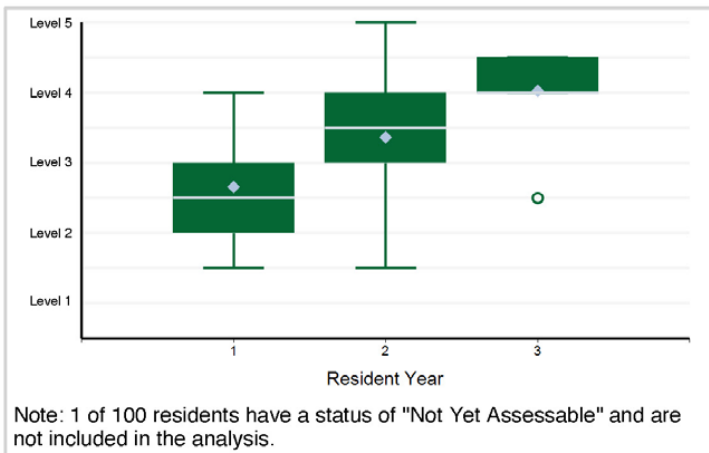

3. Patient Care - Patient Care 3: Valvular Disease

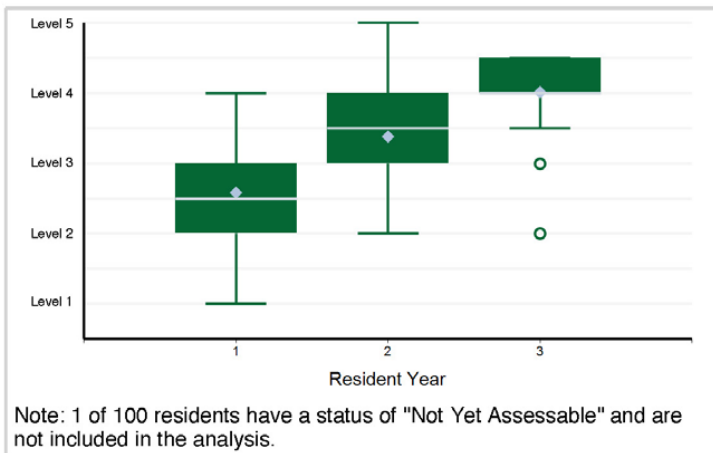

4. Patient Care - Patient Care 4: Great Vessel Disease

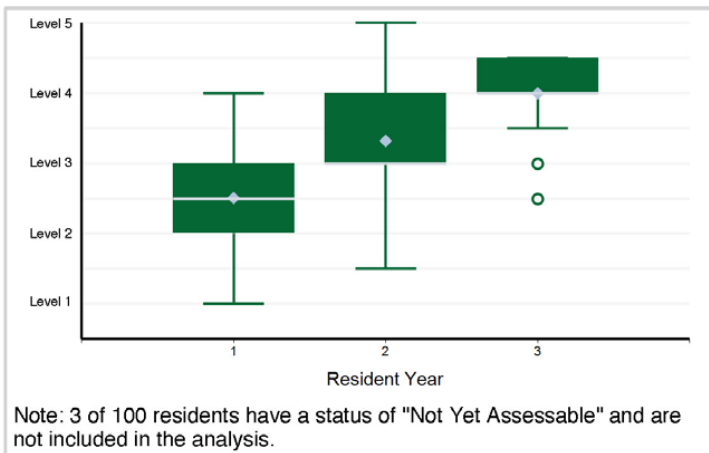

5. Patient Care - Patient Care 5: Esophagus

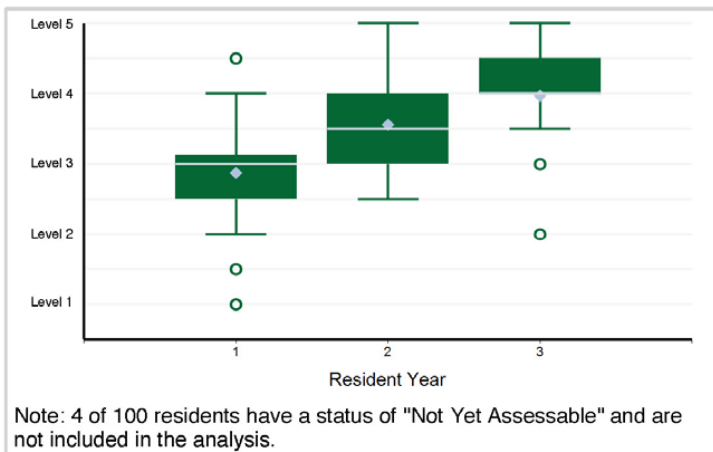

6. Patient Care - Patient Care 6: Lung and Airway

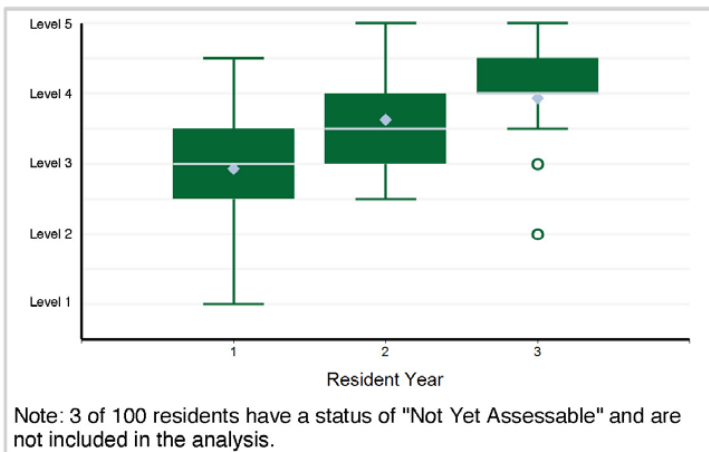

Specialty Box Plot Report - Milestone Evaluation by Resident Year: Year-End 2021-2022

SPECIALTY: Thoracic Surgery - Independent (Three-Year Program)

7. Patient Care - Patient Care 7: Chest Wall/Pleura/Mediastinum/Diaphragm

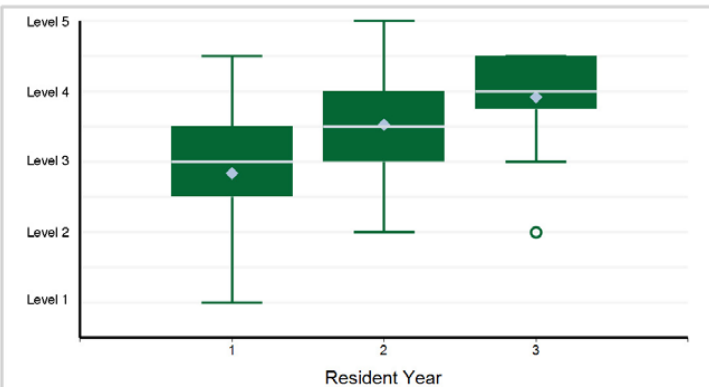

Note: 4 of 100 residents have a status of "Not Yet Assessable" and are not included in the analysis.

8. Patient Care - Patient Care 8: Critical Care

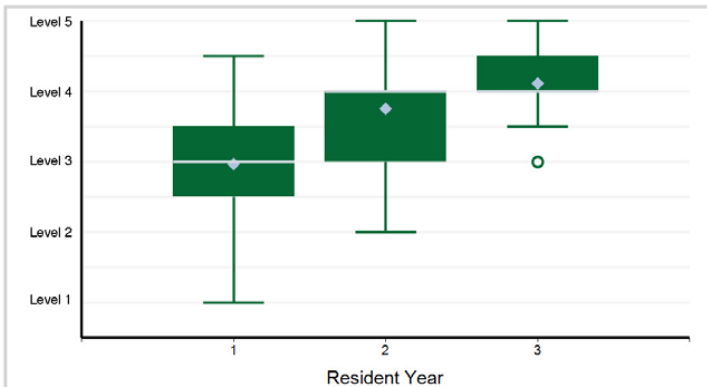

Note: 1 of 100 residents have a status of "Not Yet Assessable" and are not included in the analysis.

9. Medical Knowledge - Medical Knowledge 1: Cardiovascular Surgical Knowledge

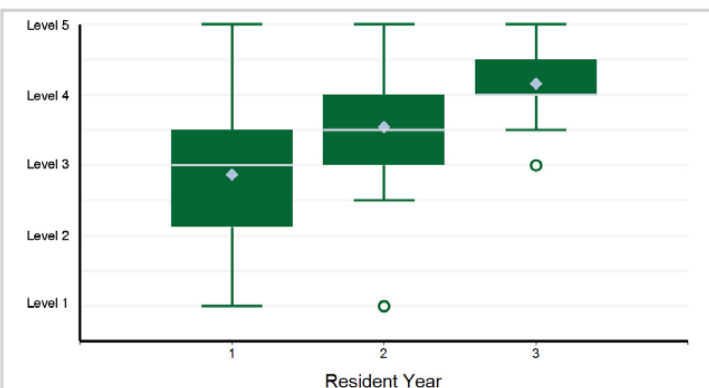

10. Medical Knowledge - Medical Knowledge 2: General Thoracic Surgical Knowledge

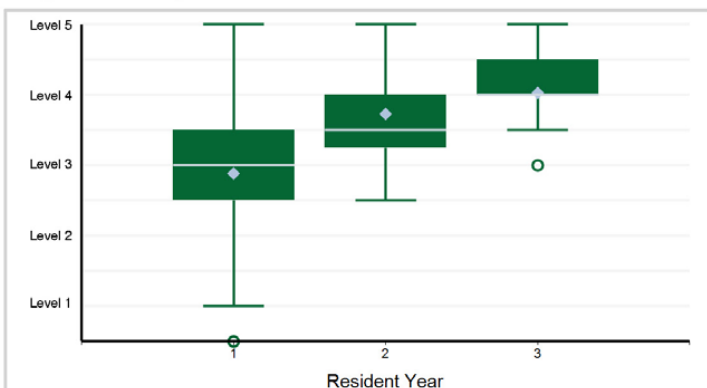

Note: 3 of 100 residents have a status of "Not Yet Assessable" and are not included in the analysis.

11. Medical Knowledge - Medical Knowledge 3: Congenital Heart Disease

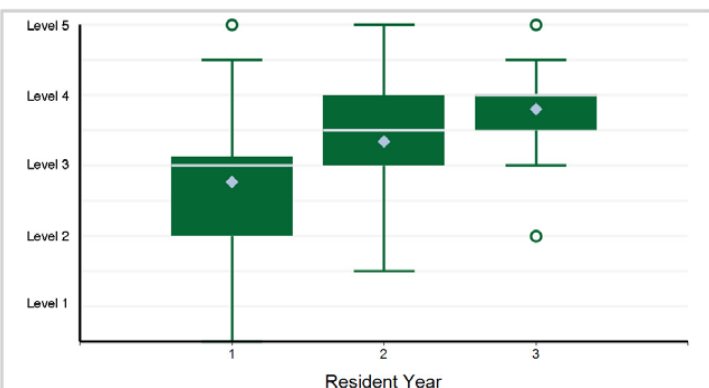

Note: 16 of 100 residents have a status of "Not Yet Assessable" and are not included in the analysis.

12. Systems-Based Practice - Systems-Based Practice 1: Patient Safety and Quality Improvement

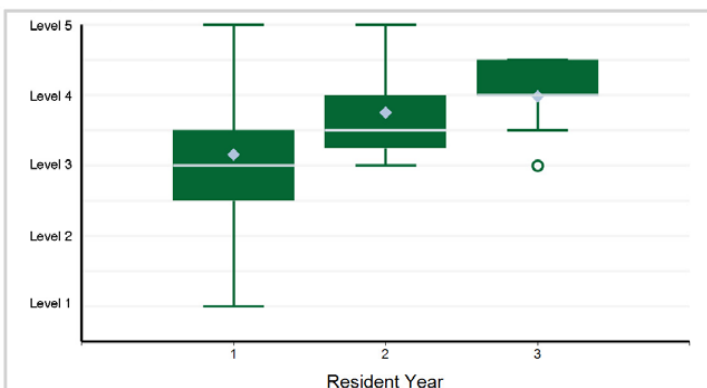

Specialty Box Plot Report - Milestone Evaluation by Resident Year: Year-End 2021-2022

SPECIALTY: Thoracic Surgery - Independent (Three-Year Program)

13. Systems-Based Practice - Systems-Based Practice 2: System Navigation for Patient-Centered Care

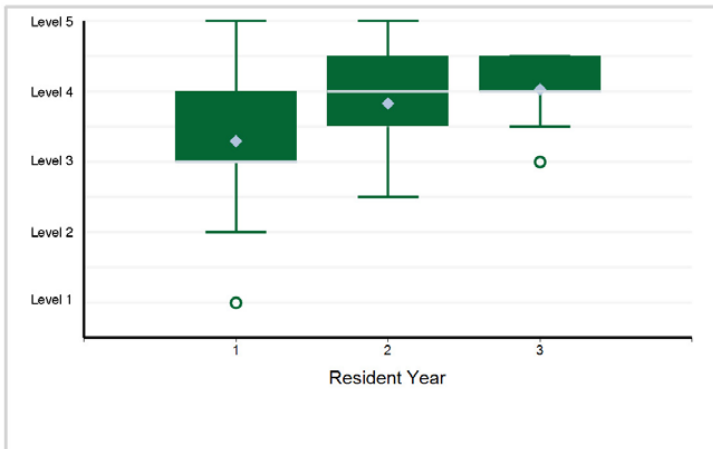

14. Systems-Based Practice - Systems-Based Practice 3: Physician Role in Health Care Systems

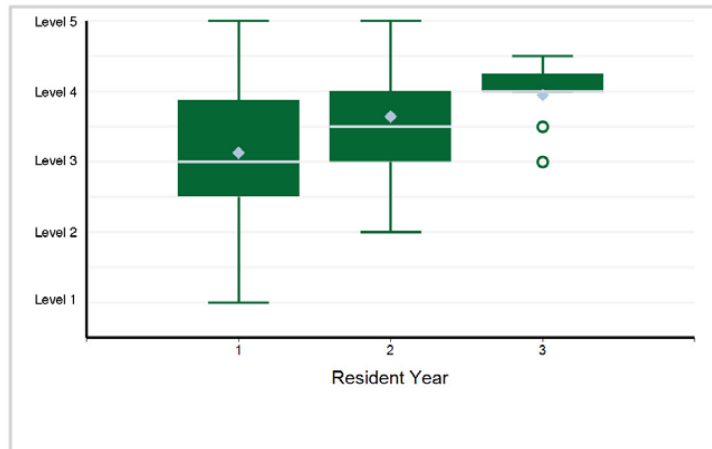

15. Practice-Based Learning and Improvement - Practice-Based Learning and Improvement 1: Evidence-Based and Informed Practice

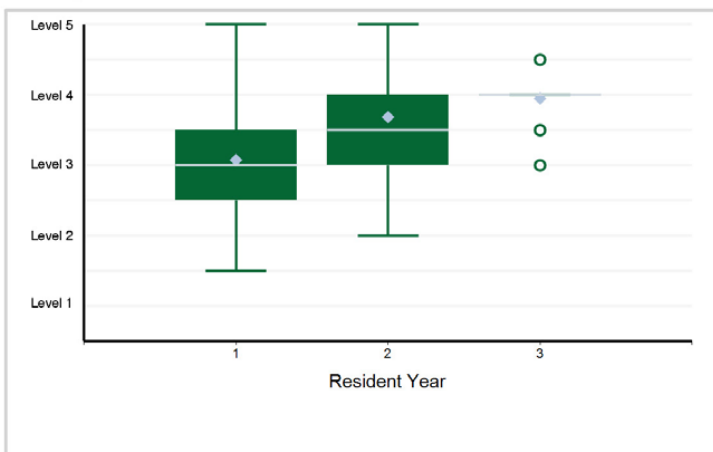

16. Practice-Based Learning and Improvement - Practice-Based Learning and Improvement 2: Reflective Practice and Commitment ...

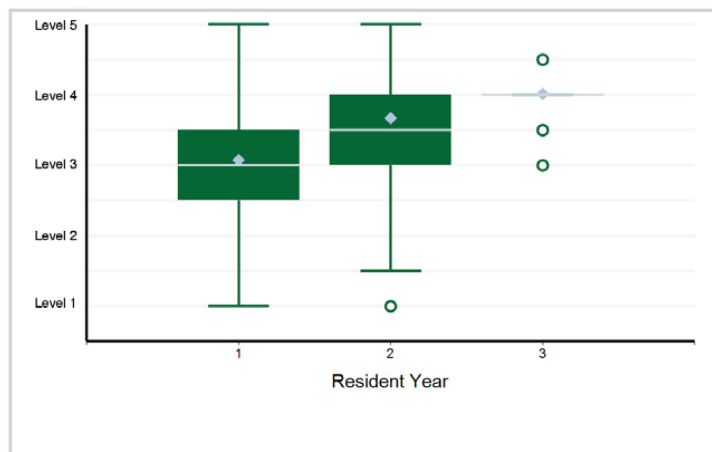

17. Professionalism - Professionalism 1: Ethical Principles

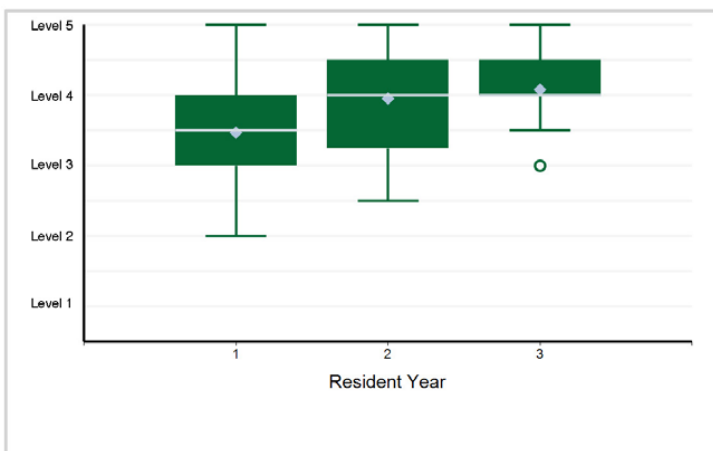

18. Professionalism - Professionalism 2: Professional Behavior and Accountability

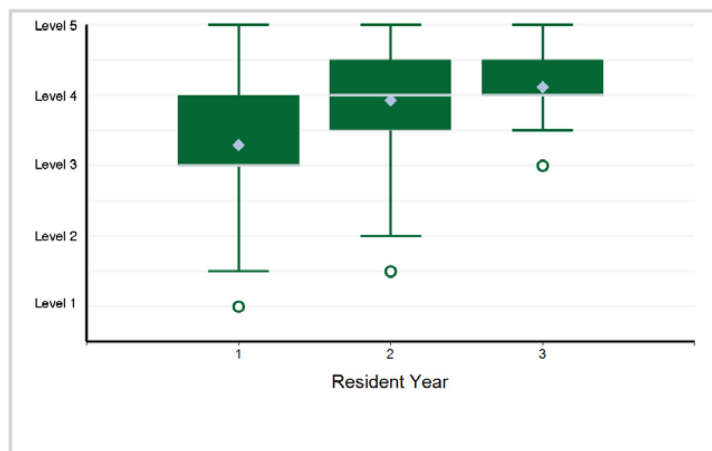

Specialty Box Plot Report - Milestone Evaluation by Resident Year: Year-End 2021-2022

SPECIALTY: Thoracic Surgery - Independent (Three-Year Program)

19. Professionalism - Professionalism 3: Administrative Tasks

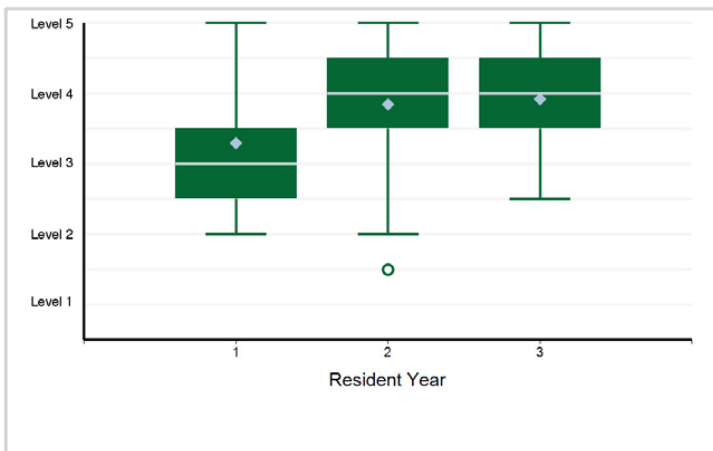

20. Professionalism - Professionalism 4: Well-Being

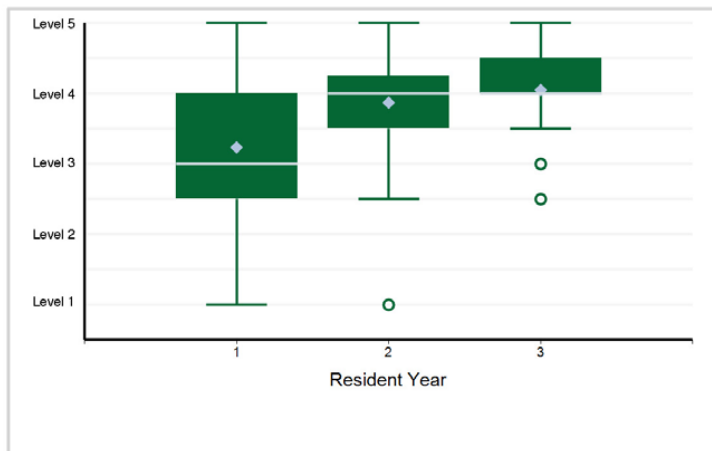

21. Interpersonal and Communication Skills - Interpersonal and Communication Skills 1: Patient- and Family-Centered Communication

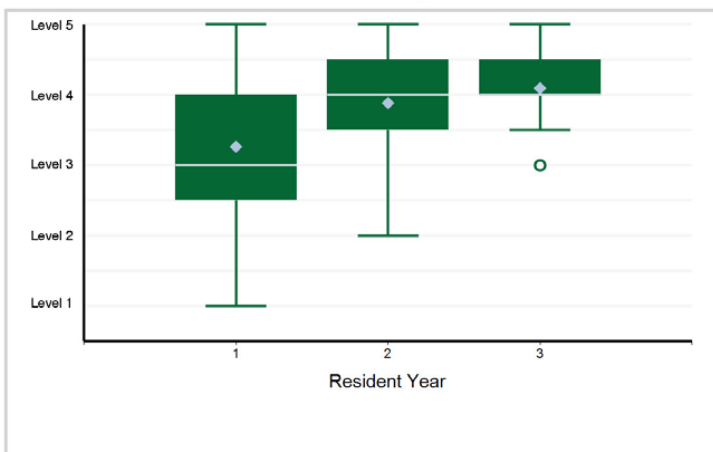

22. Interpersonal and Communication Skills - Interpersonal and Communication Skills 2: Interprofessional and Team Communication

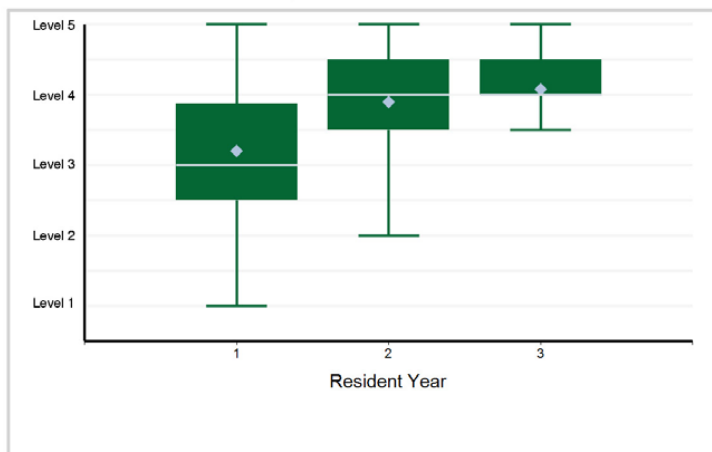

23. Interpersonal and Communication Skills - Interpersonal and Communication Skills 3: Communication within Health Care Systems

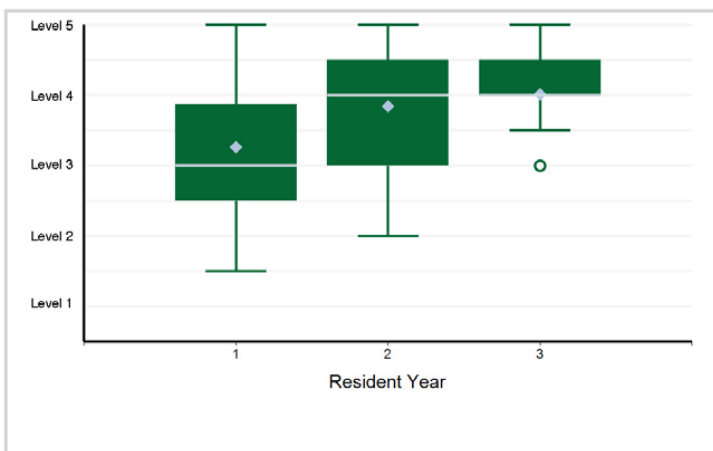

Specialty Box Plot Report - Milestone Evaluation by Resident Year: Year-End 2021-2022

TABLE 146: SPECIALTY: **Thoracic Surgery - Integrated**

Resident Year	1	2	3	4	5	6	Total Residents
# of Residents	47	41	43	36	32	32	231

1. Patient Care - Patient Care 1: Ischemic Heart Disease

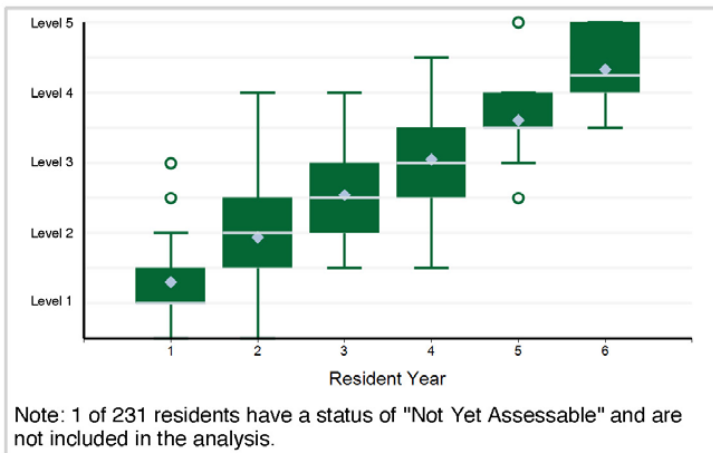

2. Patient Care - Patient Care 2: Mechanical Circulatory Support

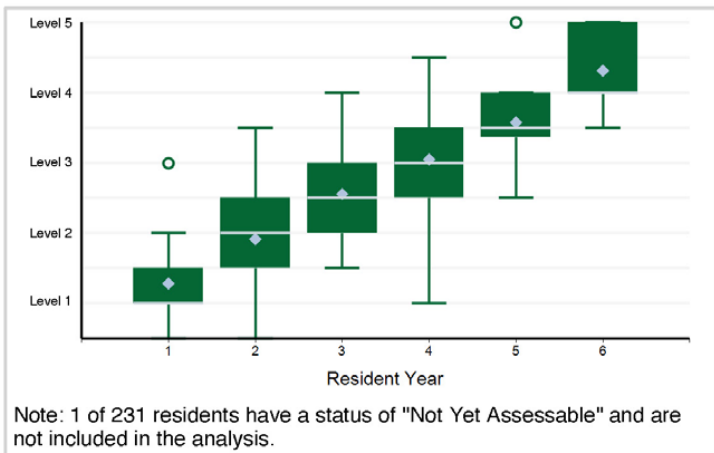

3. Patient Care - Patient Care 3: Valvular Disease

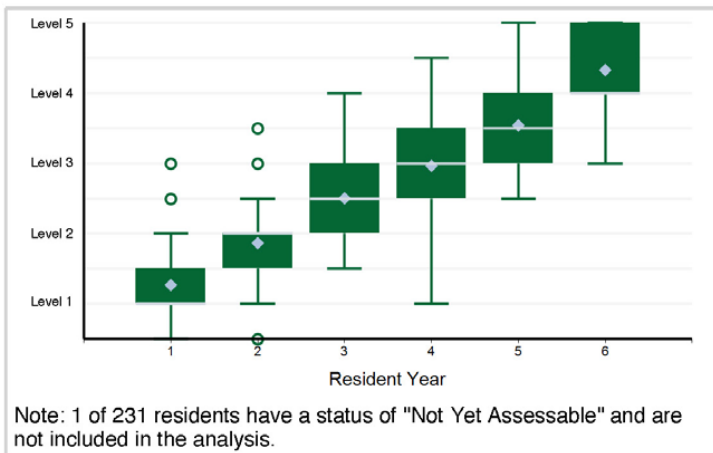

4. Patient Care - Patient Care 4: Great Vessel Disease

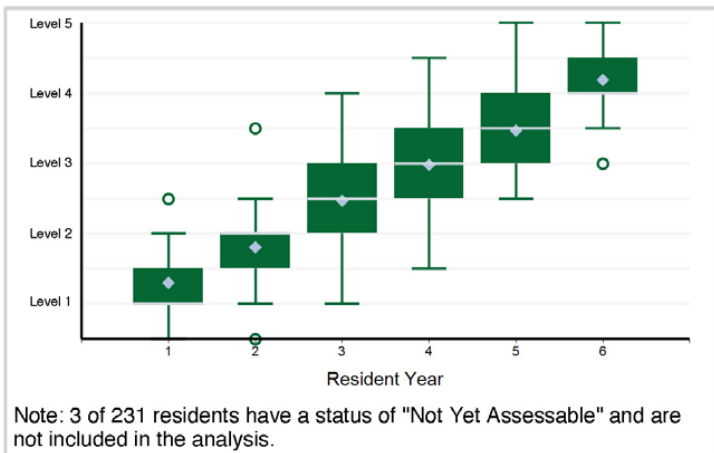

5. Patient Care - Patient Care 5: Esophagus

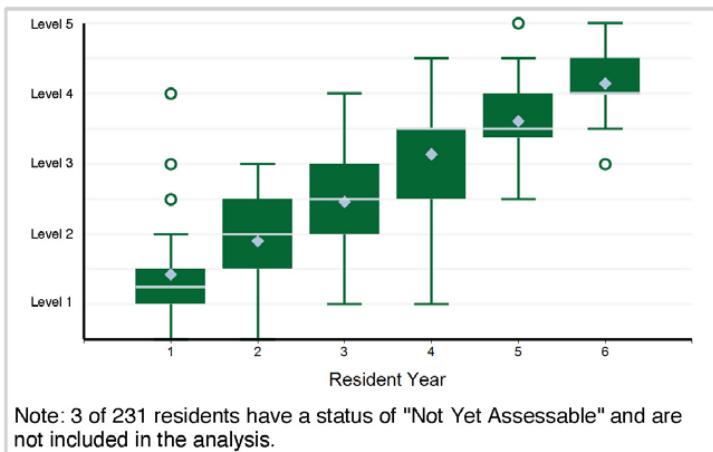

6. Patient Care - Patient Care 6: Lung and Airway

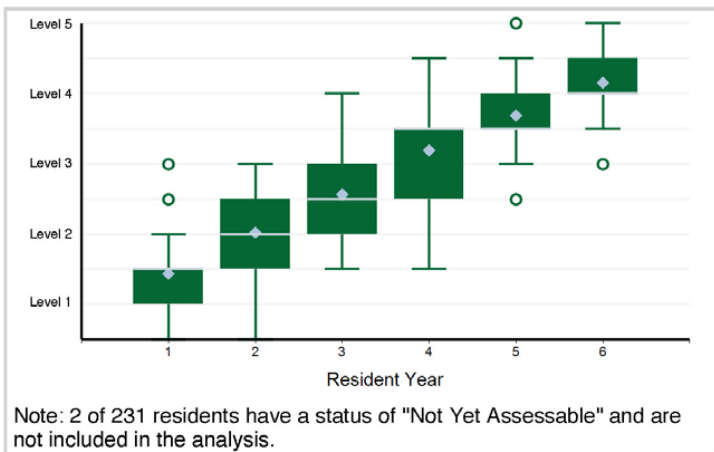

Specialty Box Plot Report - Milestone Evaluation by Resident Year: Year-End 2021-2022

SPECIALTY: Thoracic Surgery - Integrated

7. Patient Care - Patient Care 7: Chest Wall/Pleura/Mediastinum/Diaphragm

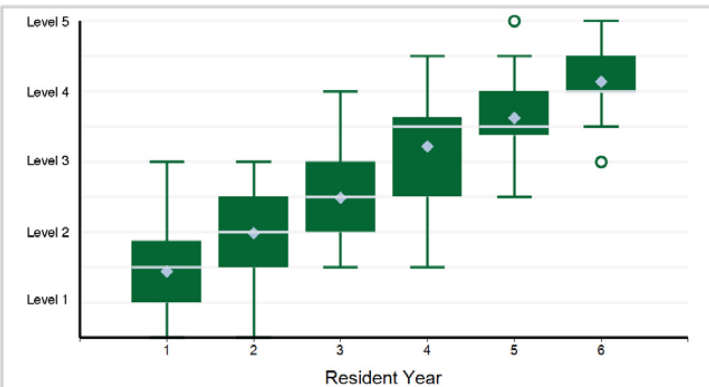

Note: 2 of 231 residents have a status of "Not Yet Assessable" and are not included in the analysis.

8. Patient Care - Patient Care 8: Critical Care

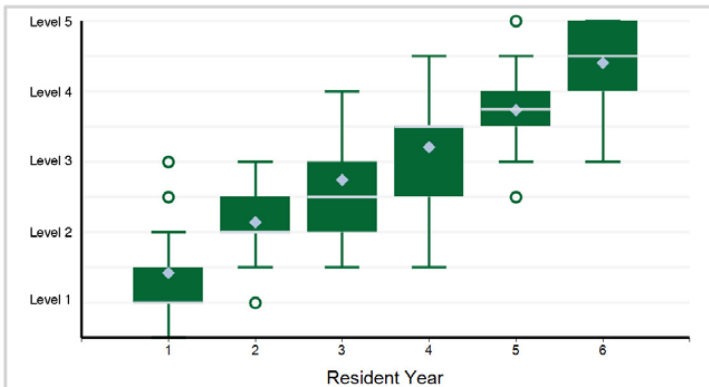

9. Patient Care - Patient Care 9: Technical Skills for General Surgery

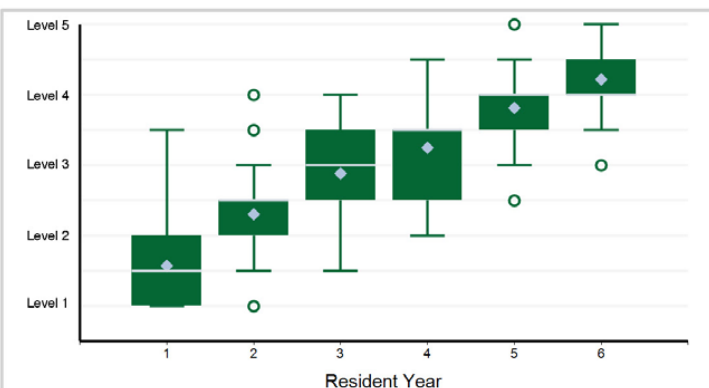

Note: 1 of 231 residents have a status of "Not Yet Assessable" and are not included in the analysis.

10. Medical Knowledge - Medical Knowledge 1: Cardiovascular Surgical Knowledge

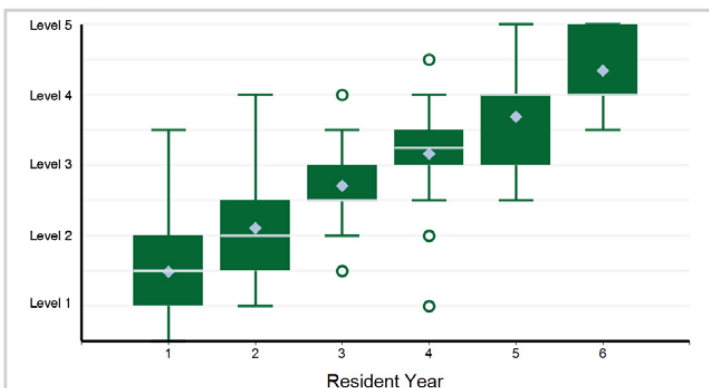

11. Medical Knowledge - Medical Knowledge 2: General Thoracic Surgical Knowledge

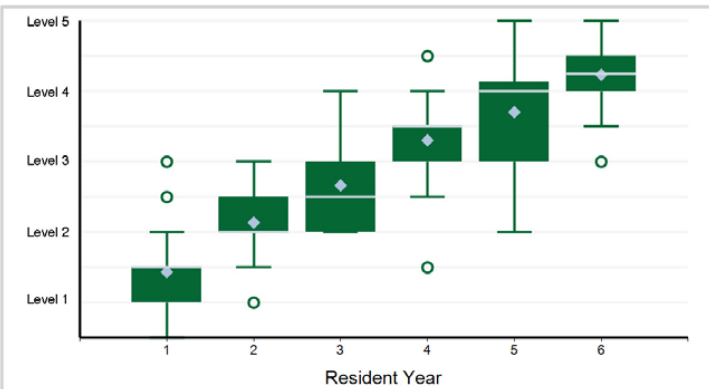

Note: 1 of 231 residents have a status of "Not Yet Assessable" and are not included in the analysis.

12. Medical Knowledge - Medical Knowledge 3: Congenital Heart Disease

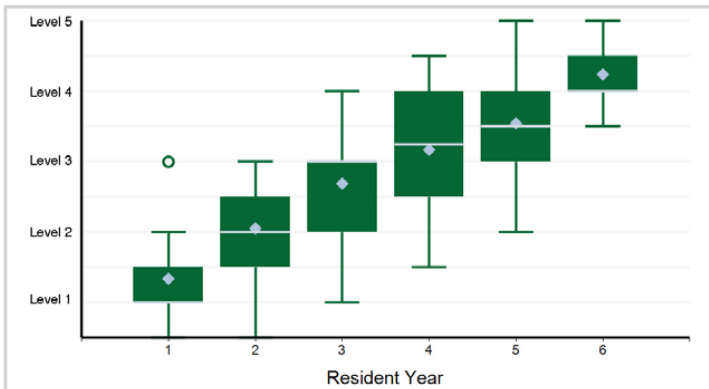

Note: 44 of 231 residents have a status of "Not Yet Assessable" and are not included in the analysis.

Specialty Box Plot Report - Milestone Evaluation by Resident Year: Year-End 2021-2022

SPECIALTY: Thoracic Surgery - Integrated

13. Systems-Based Practice - Systems-Based Practice 1: Patient Safety and Quality Improvement

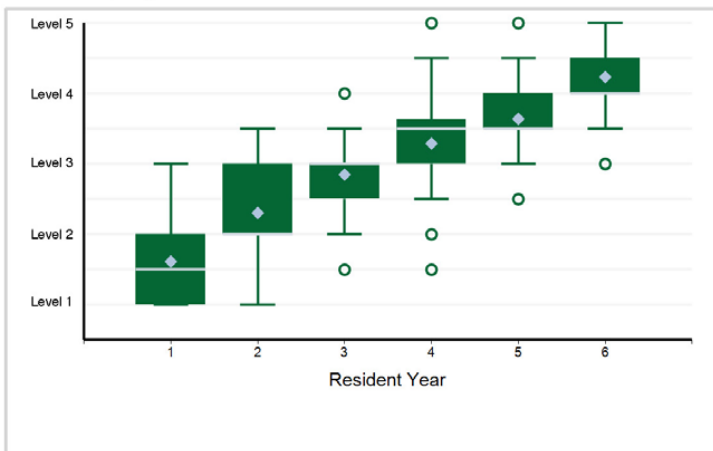

14. Systems-Based Practice - Systems-Based Practice 2: System Navigation for Patient-Centered Care

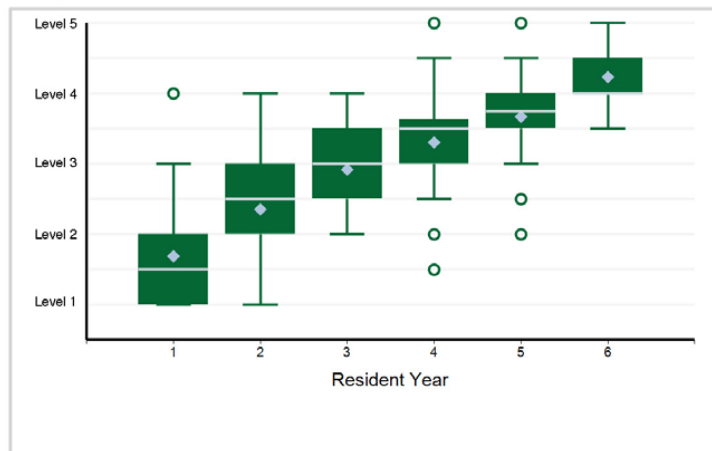

15. Systems-Based Practice - Systems-Based Practice 3: Physician Role in Health Care Systems

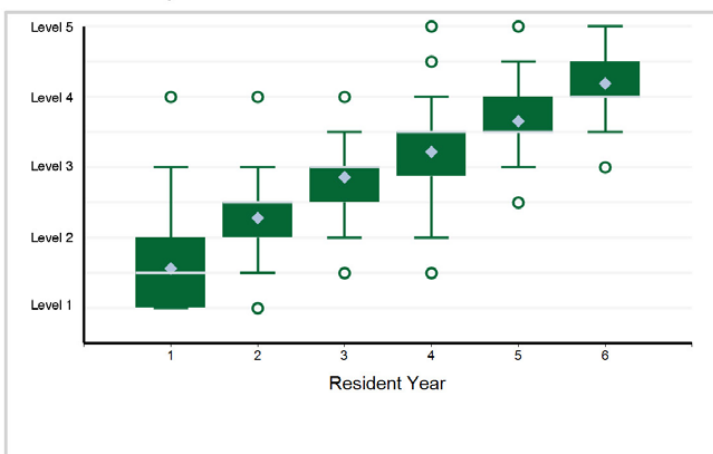

16. Practice-Based Learning and Improvement - Practice-Based Learning and Improvement 1: Evidence-Based and Informed Practice

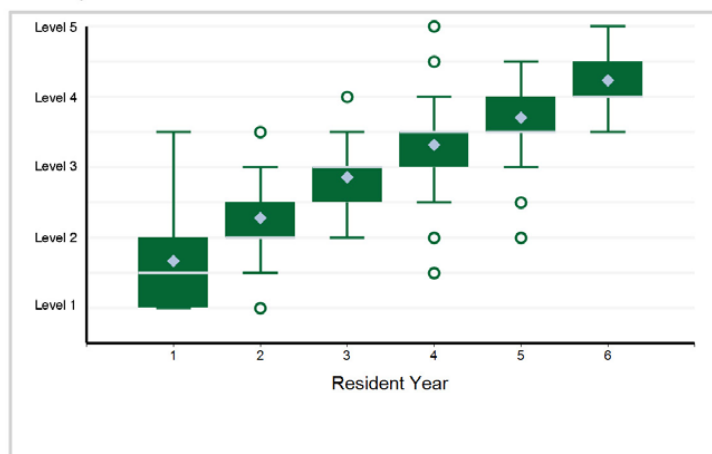

17. Practice-Based Learning and Improvement - Practice-Based Learning and Improvement 2: Reflective Practice and Commitment ...

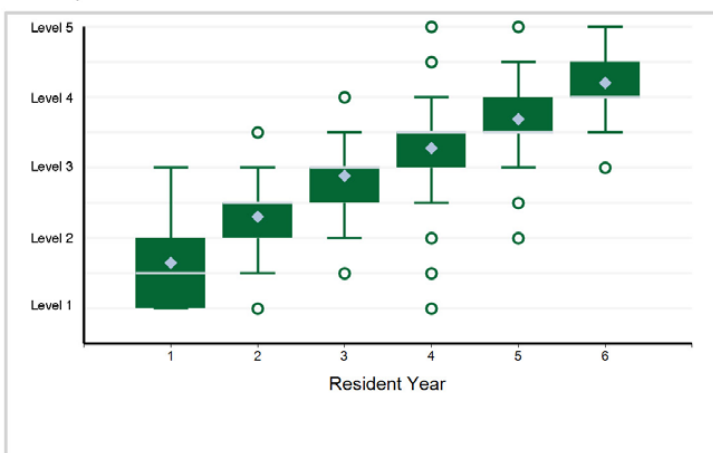

18. Professionalism - Professionalism 1: Ethical Principles

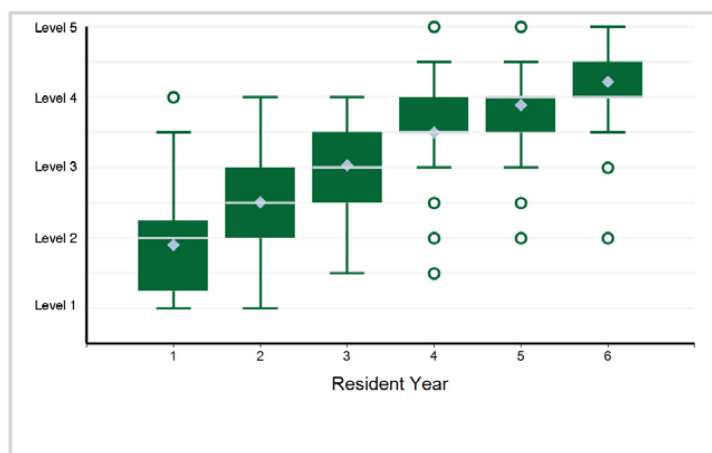

Specialty Box Plot Report - Milestone Evaluation by Resident Year: Year-End 2021-2022

SPECIALTY: Thoracic Surgery - Integrated

19. Professionalism - Professionalism 2: Professional Behavior and Accountability

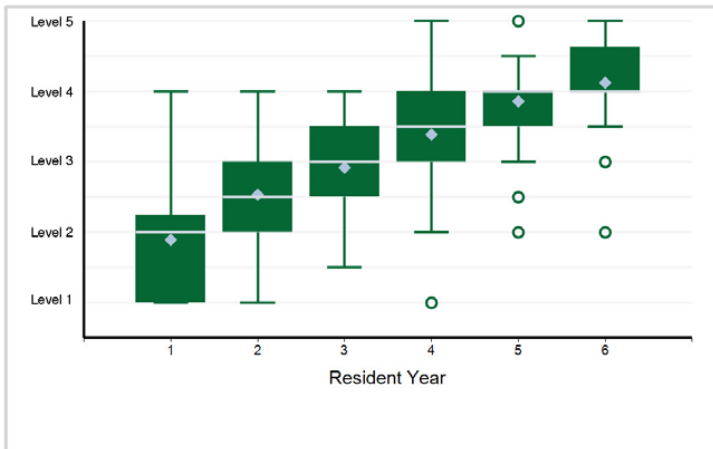

20. Professionalism - Professionalism 3: Administrative Tasks

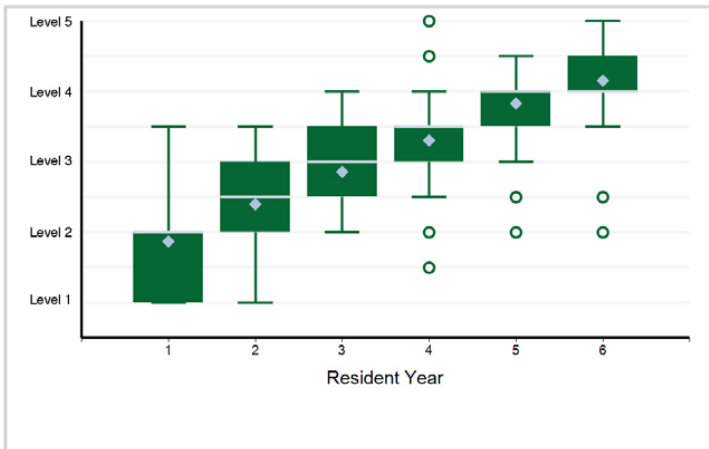

21. Professionalism - Professionalism 4: Well-Being

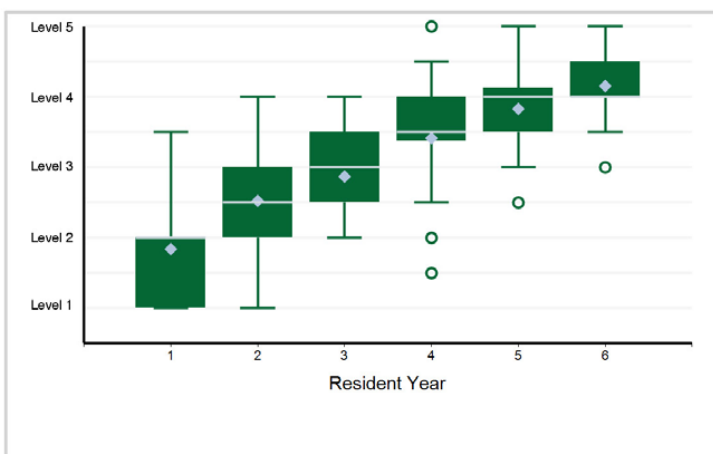

22. Interpersonal and Communication Skills - Interpersonal and Communication Skills 1: Patient- and Family-Centered Communication

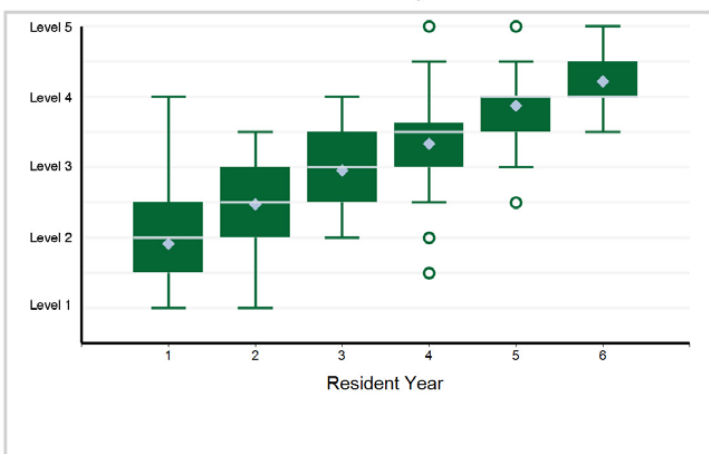

23. Interpersonal and Communication Skills - Interpersonal and Communication Skills 2: Interprofessional and Team Communication

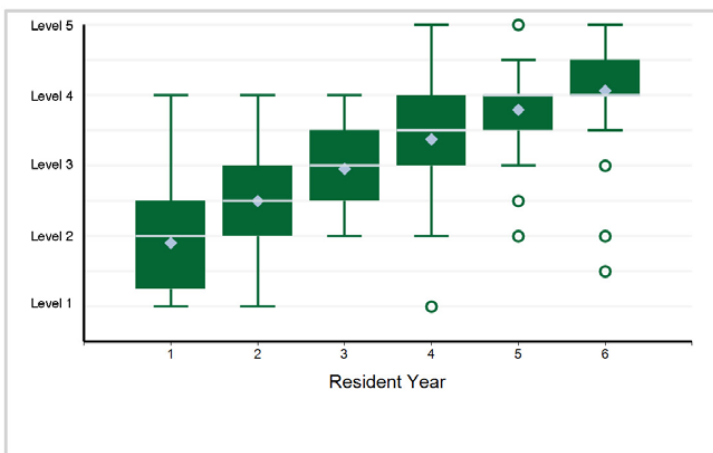

24. Interpersonal and Communication Skills - Interpersonal and Communication Skills 3: Communication within Health Care Systems

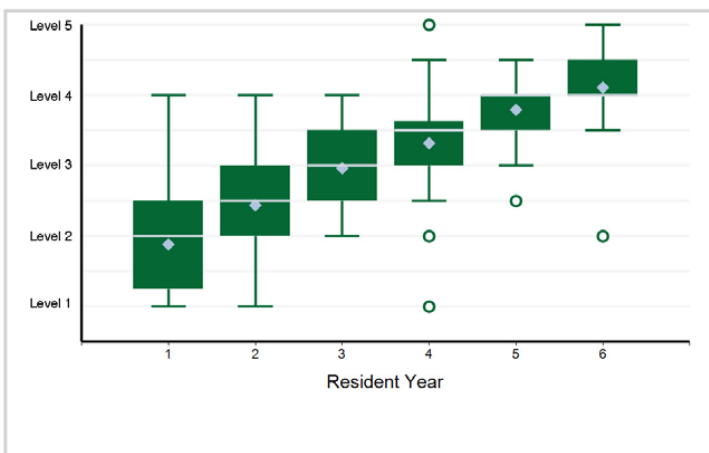

Specialty Box Plot Report - Milestone Evaluation by Resident Year: Year-End 2021-2022

TABLE 147: SUBSPECIALTY: **Congenital Cardiac Surgery**

Resident Year	1	Total Residents*
# of Residents	13	13

*Note: There are 1 residents with an incomplete milestone evaluation that are excluded from the box plots below.

1. Patient Care - Patient Care — Technical Skills and Performance

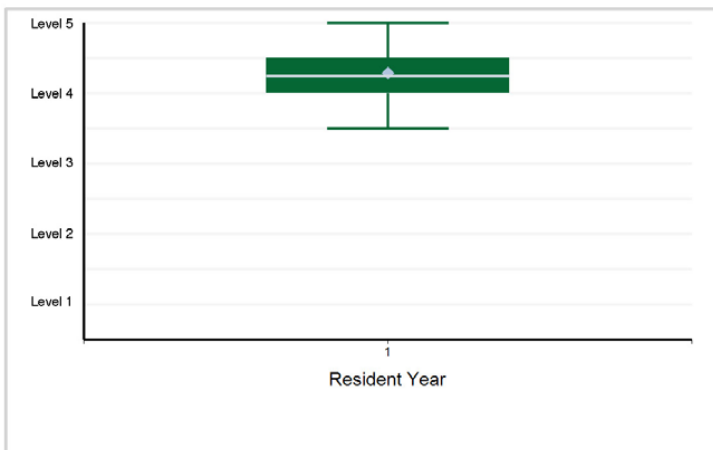

2. Patient Care - Patient Care — Pre- and Post-operative Care

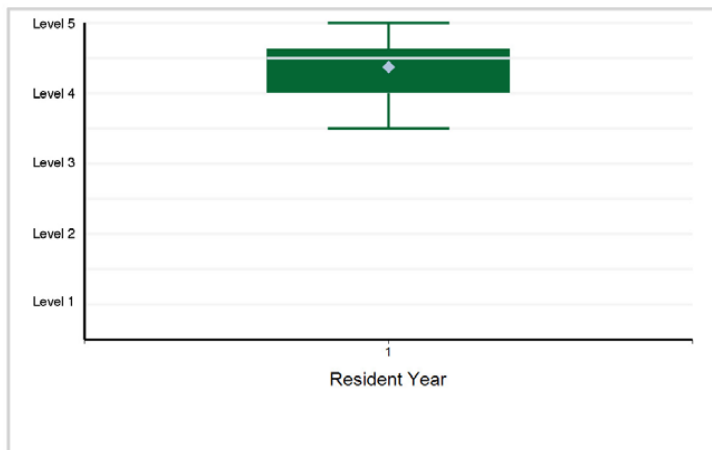

3. Medical Knowledge - Medical Knowledge — Anatomy and Diagnosis

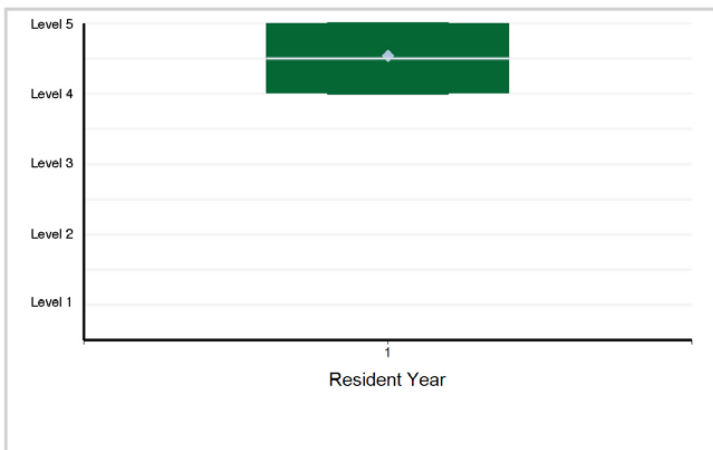

4. Medical Knowledge - Medical Knowledge — Pathophysiology and Natural History of the Disease

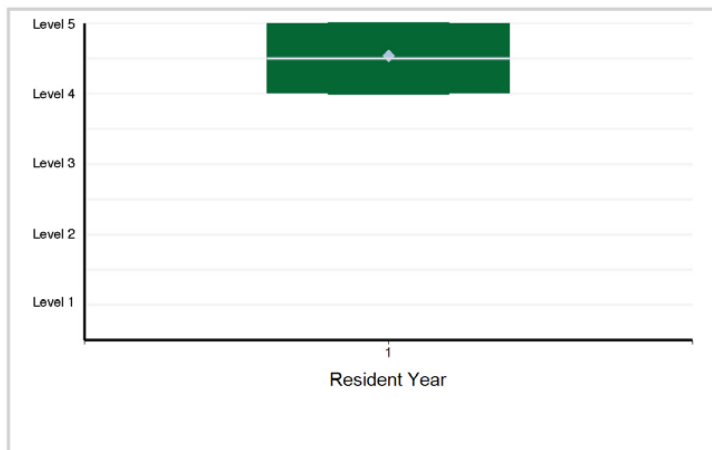

5. Medical Knowledge - Medical Knowledge — Pathophysiology and Management of the Post-operative State

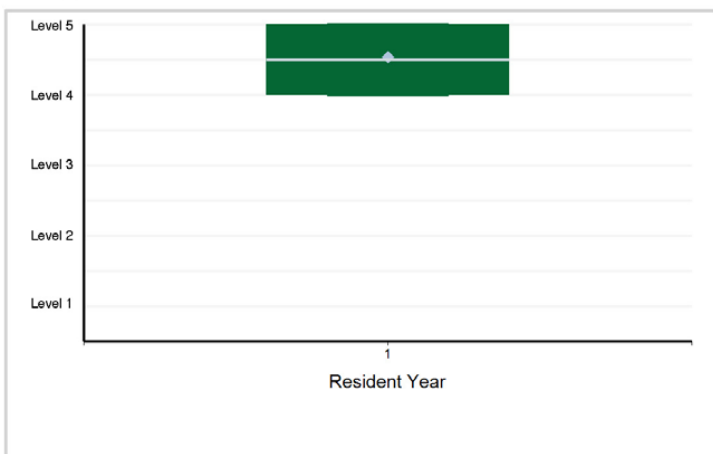

6. Systems-Based Practice - Systems-Based Practice

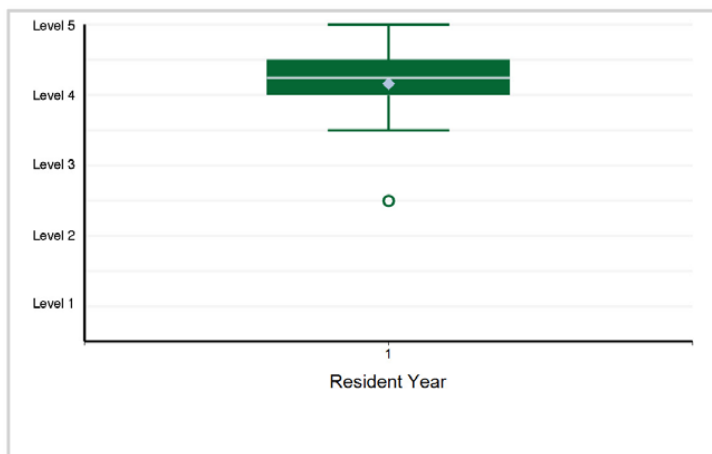

Specialty Box Plot Report - Milestone Evaluation by Resident Year: Year-End 2021-2022

SUBSPECIALTY: Congenital Cardiac Surgery

7. Practice-Based Learning and Improvement - Practice-Based Learning and Improvement

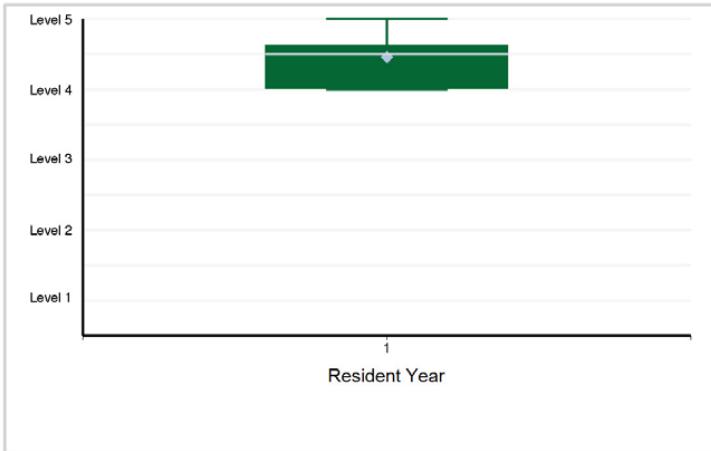

8. Professionalism - Professionalism

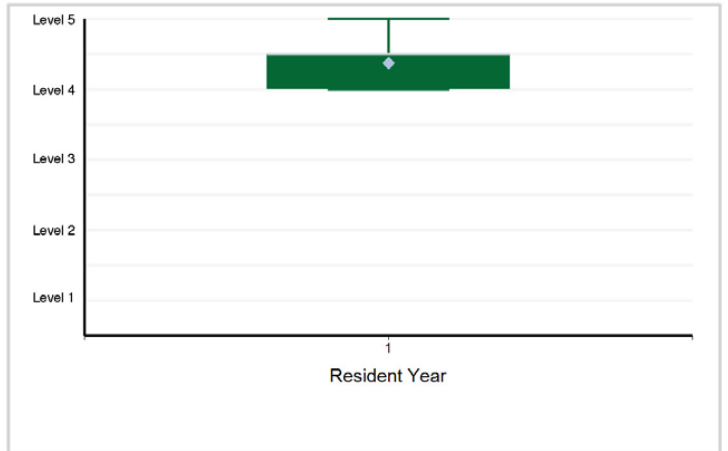

9. Interpersonal and Communication Skills - Interpersonal and Communication Skills

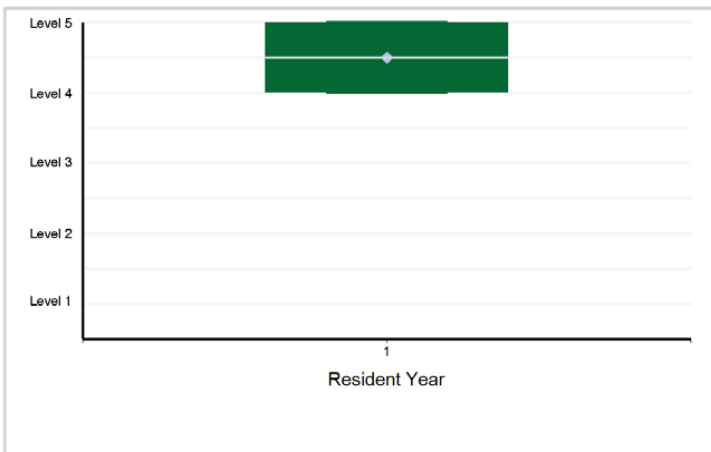

Specialty Box Plot Report - Milestone Evaluation by Resident Year: Year-End 2021-2022

TABLE 148: SPECIALTY: **Transitional Year**

Resident Year	1	Total Residents
# of Residents	1,780	1,780

1. Patient Care - 1: History

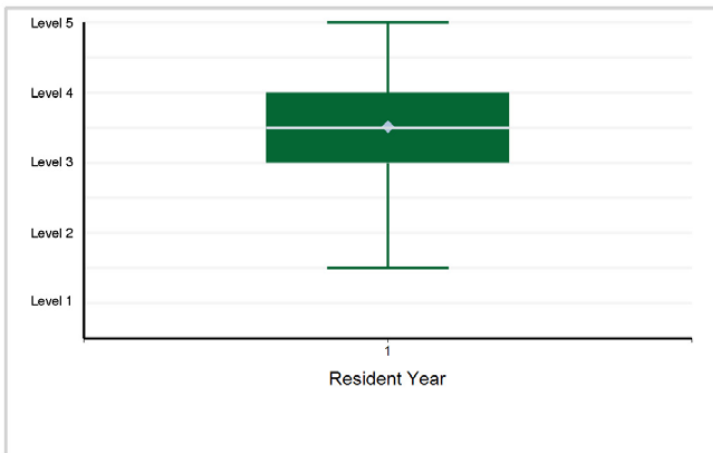

2. Patient Care - 2: Physical Examination

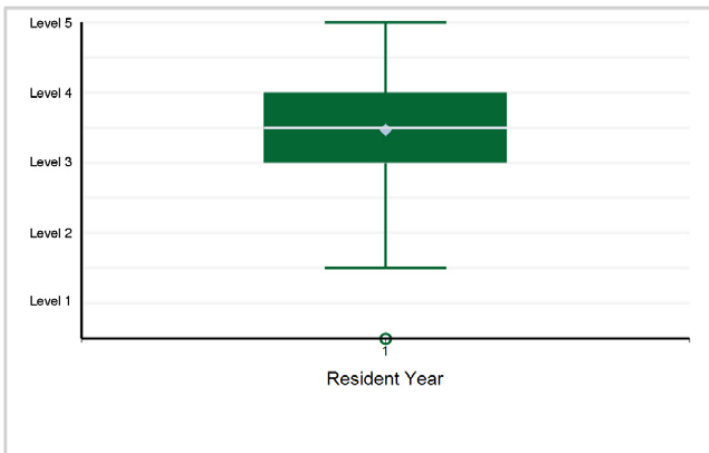

3. Patient Care - 3: Differential Diagnosis and Assessment

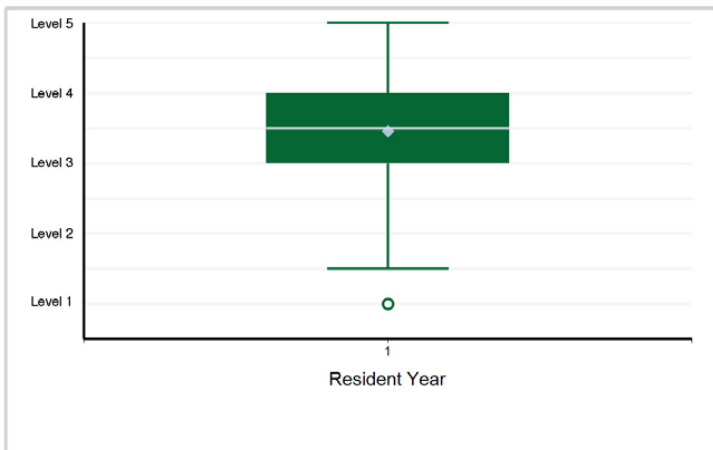

4. Patient Care - 4: Clinical Management

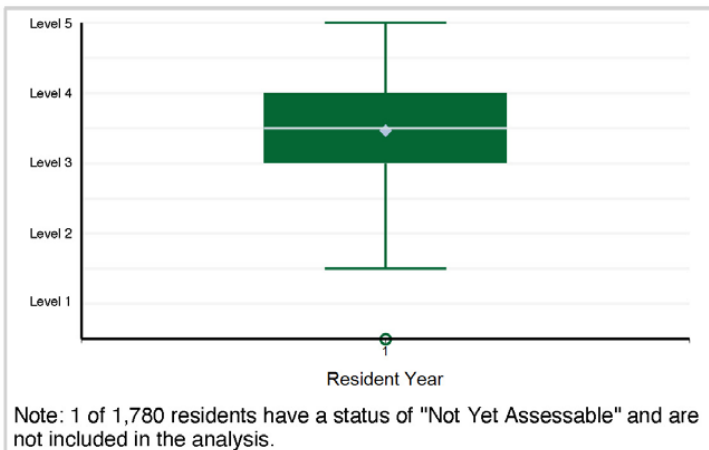

5. Patient Care - 5: Urgent and Emergent Medical Conditions

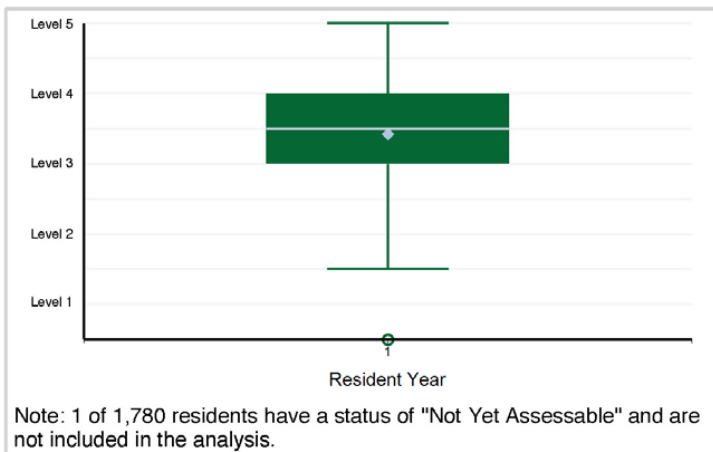

6. Patient Care - 6: Care of Diverse Patients

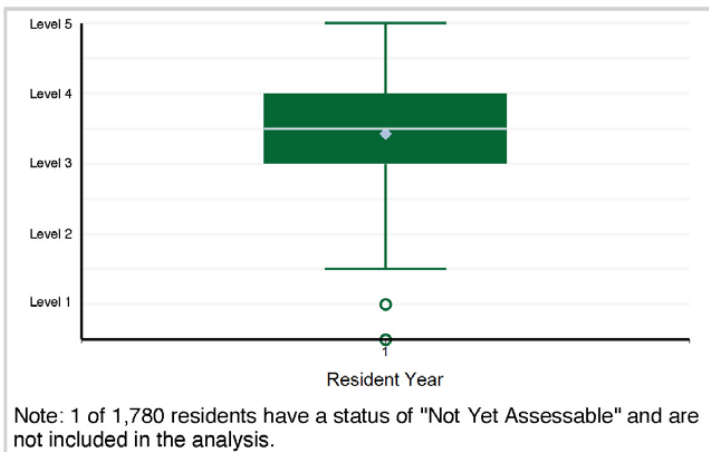

Specialty Box Plot Report - Milestone Evaluation by Resident Year: Year-End 2021-2022

SPECIALTY: **Transitional Year**

7. Medical Knowledge - 1: Clinical Reasoning

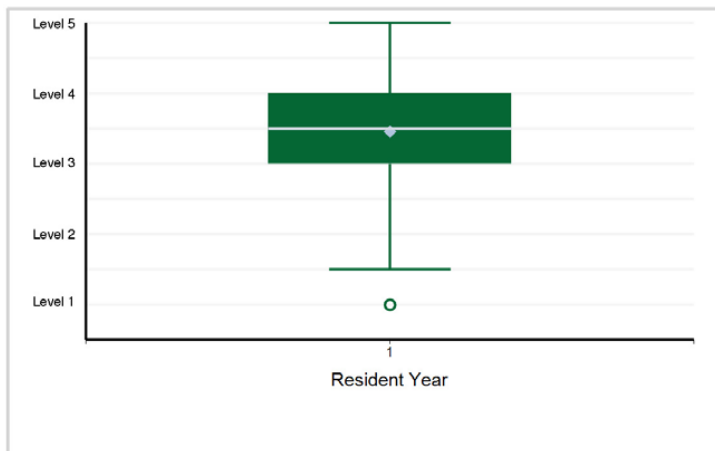

8. Medical Knowledge - 2: Procedural Knowledge and Informed Consent

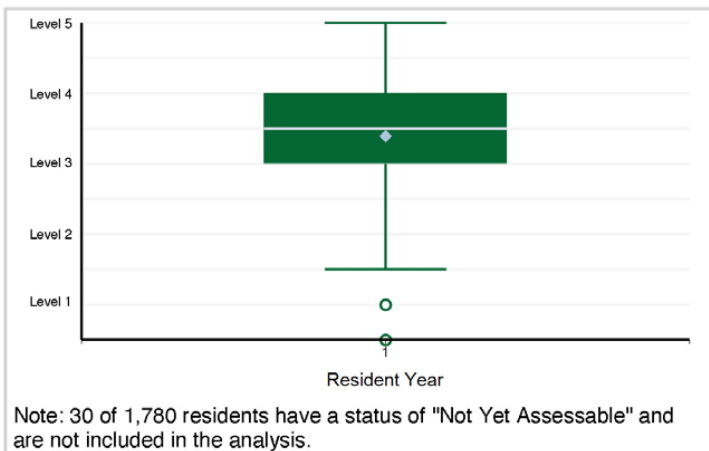

9. Systems-Based Practice - 1: Patient Safety and Quality Improvement

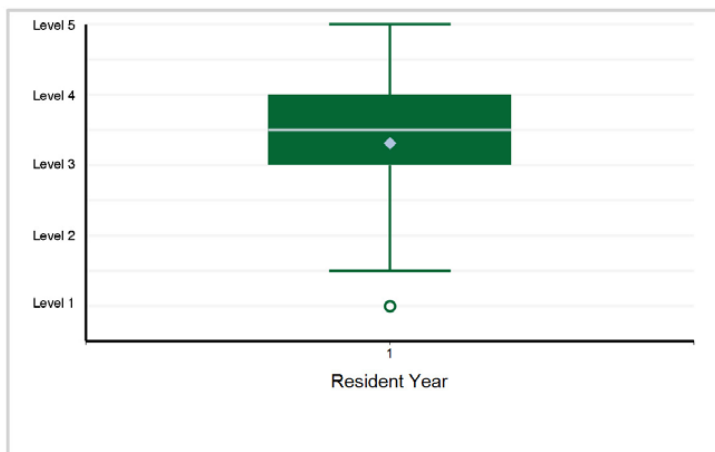

10. Systems-Based Practice - 2: System Navigation for Patient-Centered Care

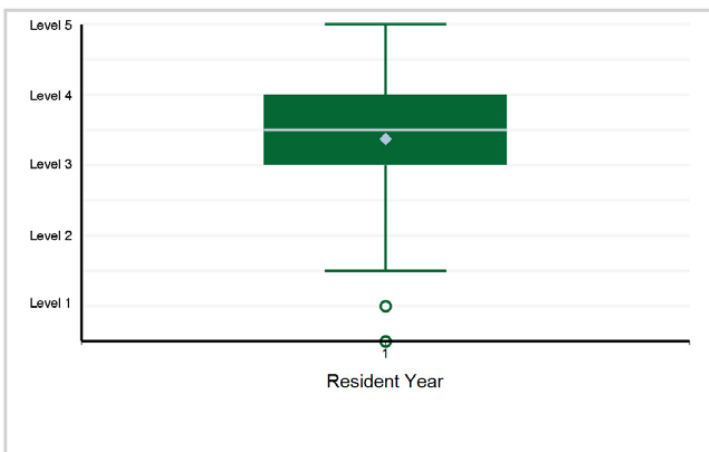

11. Systems-Based Practice - 3: Physician Role in Health Care Systems

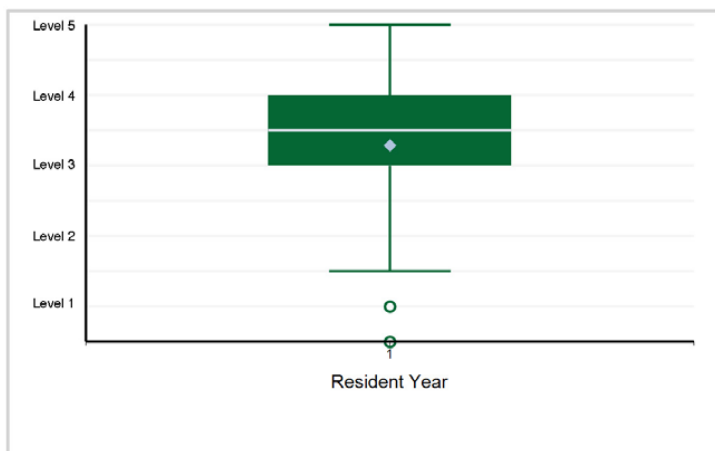

12. Practice-Based Learning and Improvement - 1: Evidence-Based and Informed Practice

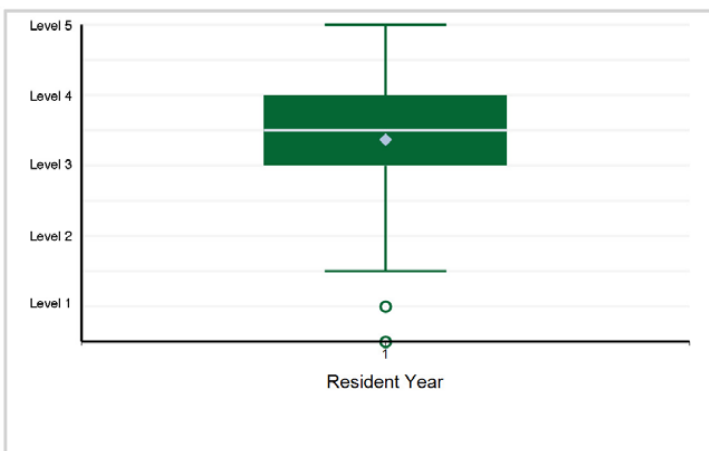

Specialty Box Plot Report - Milestone Evaluation by Resident Year: Year-End 2021-2022

SPECIALTY: Transitional Year

13. Practice-Based Learning and Improvement - 2: Reflective Practice and Personal Growth

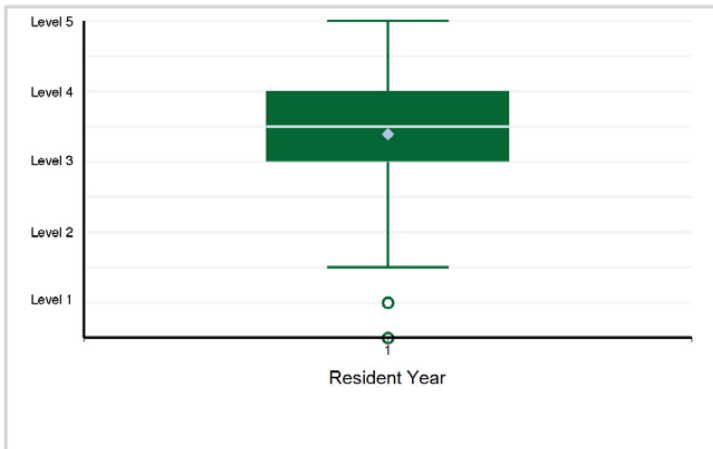

14. Professionalism - 1: Professional and Ethical Behavior

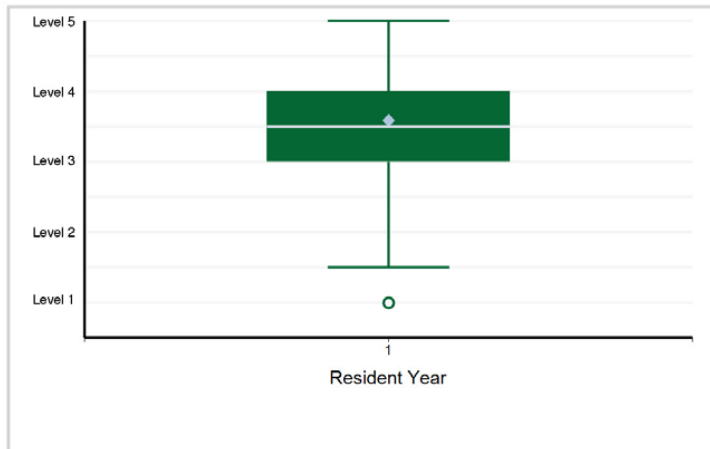

15. Professionalism - 2: Accountability and Conscientiousness

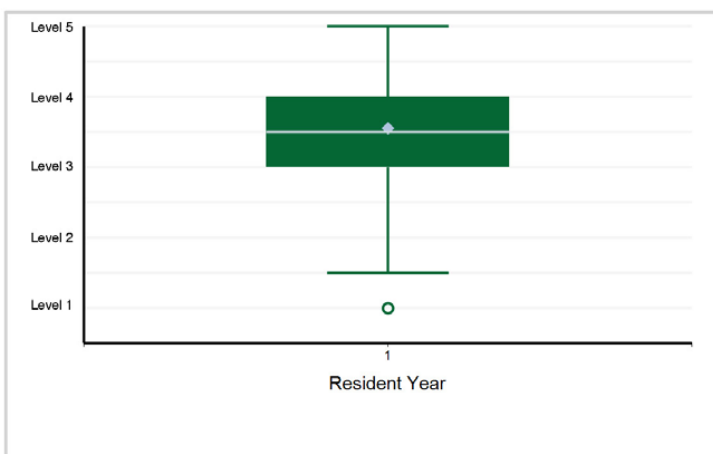

16. Professionalism - 3: Self-Awareness and Help-Seeking

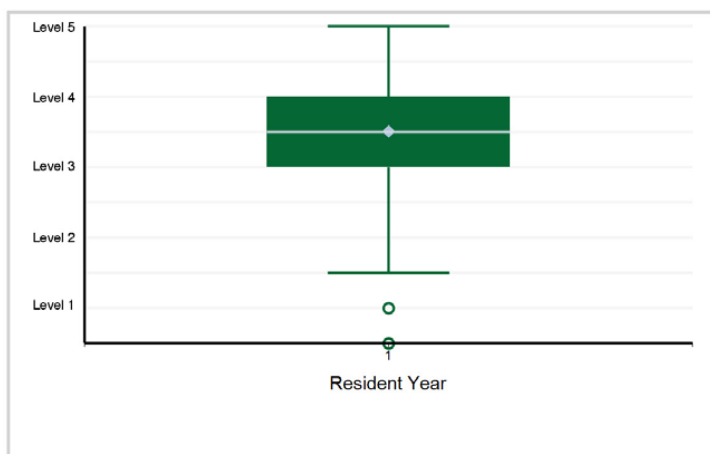

17. Interpersonal and Communication Skills - 1: Patient and Family-Centered Communication

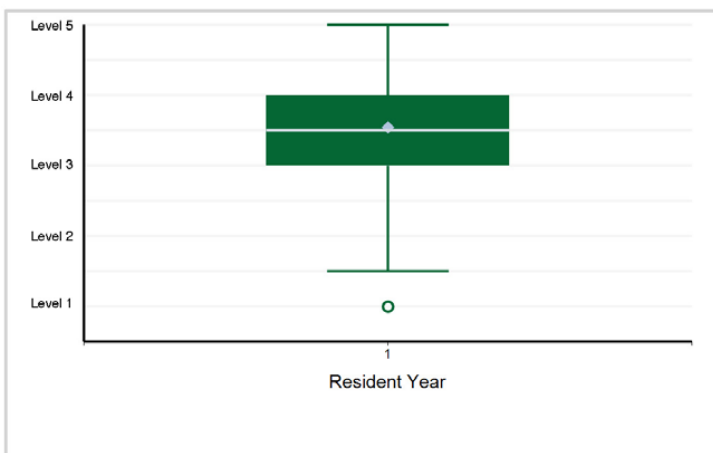

18. Interpersonal and Communication Skills - 2: Interprofessional and Team Communication

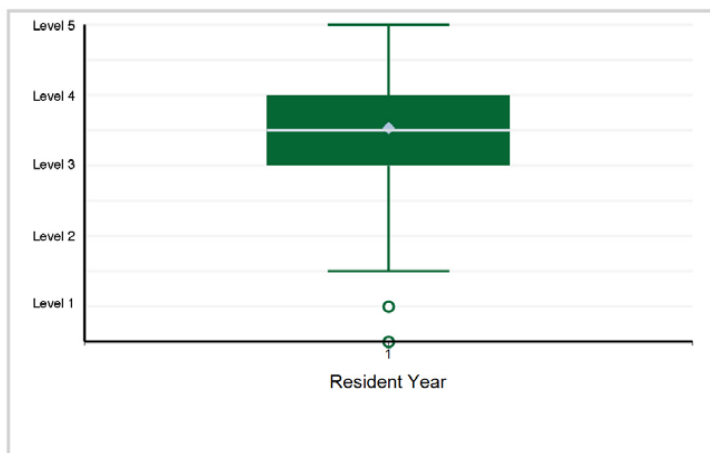

Specialty Box Plot Report - Milestone Evaluation by Resident Year: Year-End 2021-2022

SPECIALTY: **Transitional Year**

19. Interpersonal and Communication Skills - 3: Communication within Health Care Systems

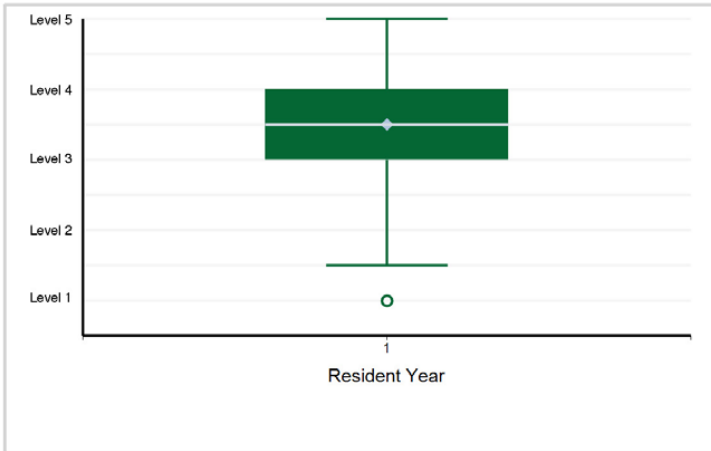

Specialty Box Plot Report - Milestone Evaluation by Resident Year: Year-End 2021-2022

TABLE 149: SPECIALTY: **Urology**

Resident Year	1	2	3	4	5	Total Residents
# of Residents	373	370	366	348	334	1,791

1. Patient Care - Patient Care 1: Patient Evaluation

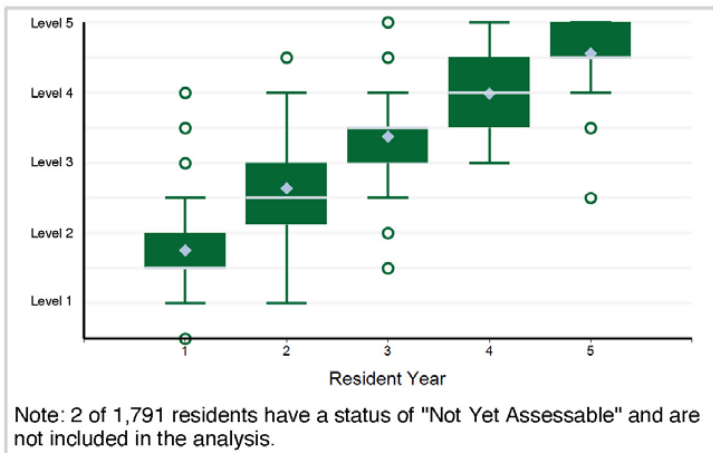

2. Patient Care - Patient Care 2: Peri-Procedural Care

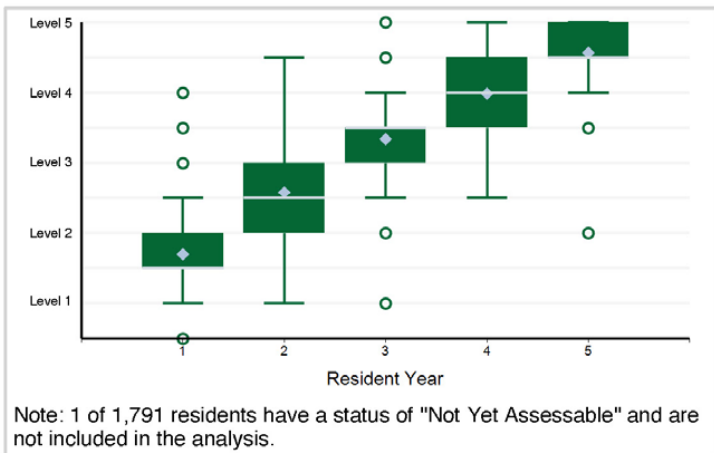

3. Patient Care - Patient Care 3: Endoscopic Procedures

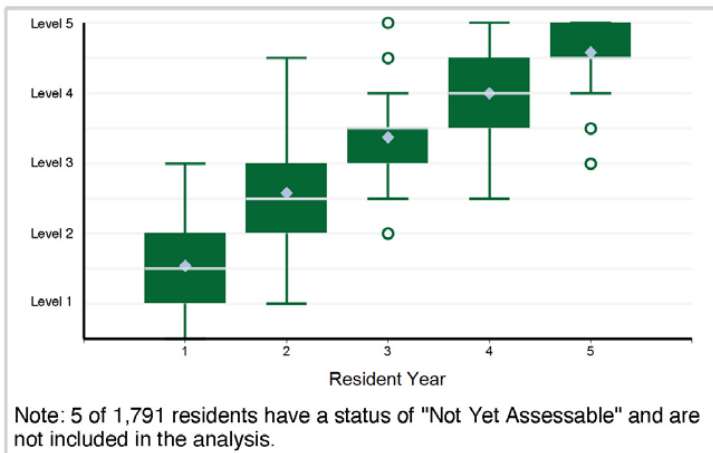

4. Patient Care - Patient Care 4: Open Procedures

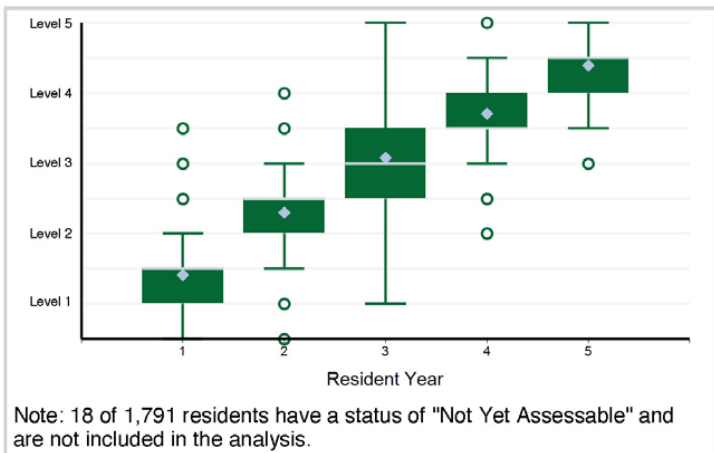

5. Patient Care - Patient Care 5: Minimally Invasive Procedures (Laparoscopic and Robotic)

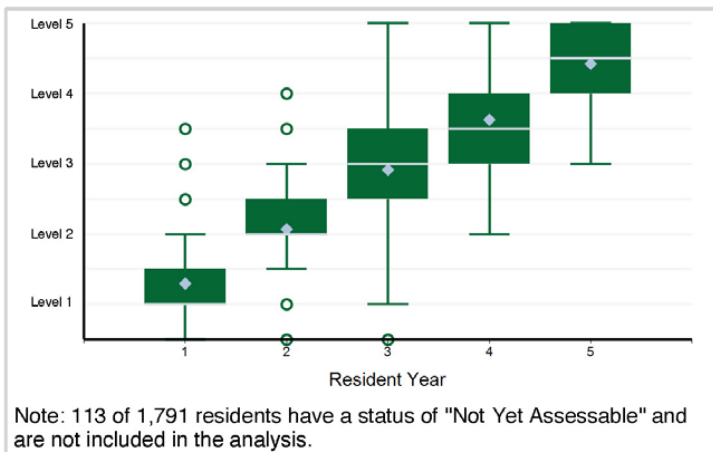

6. Patient Care - Patient Care 6: Office-Based Procedures

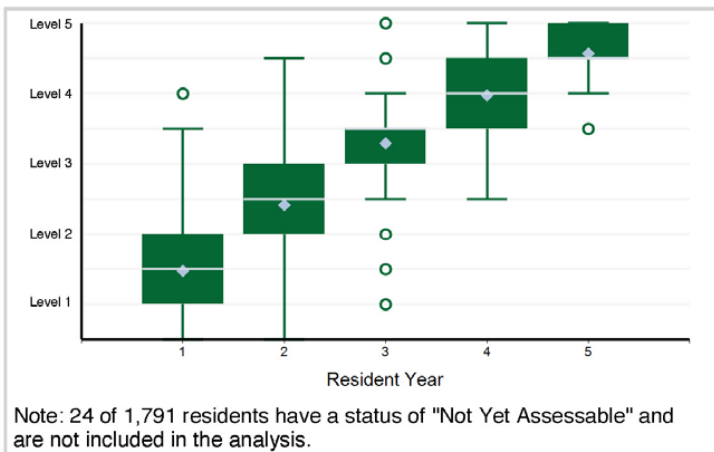

Specialty Box Plot Report - Milestone Evaluation by Resident Year: Year-End 2021-2022

SPECIALTY: Urology

7. Medical Knowledge - Medical Knowledge 1: Clinical Medical Knowledge

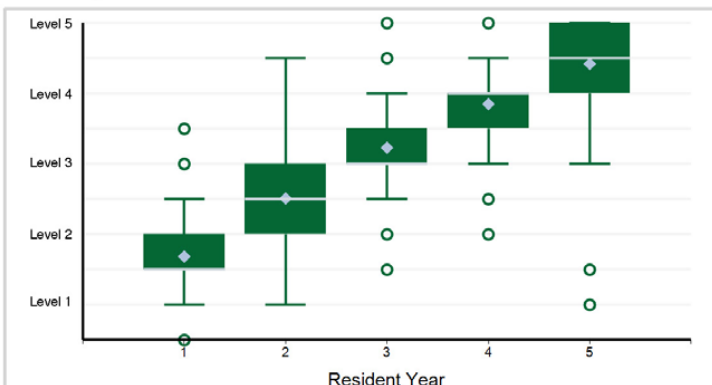

Note: 1 of 1,791 residents have a status of "Not Yet Assessable" and are not included in the analysis.

8. Medical Knowledge - Medical Knowledge 2: Clinical Reasoning

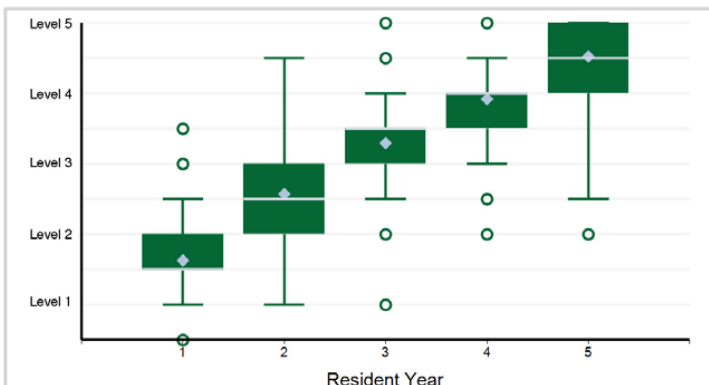

Note: 2 of 1,791 residents have a status of "Not Yet Assessable" and are not included in the analysis.

9. Systems-Based Practice - Systems-Based Practice 1: Patient Safety and Quality Improvement

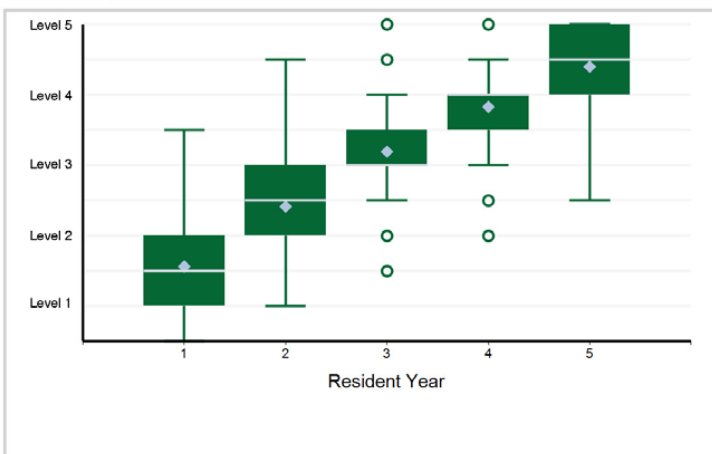

10. Systems-Based Practice - Systems-Based Practice 2: System Navigation for Patient-Centered Care

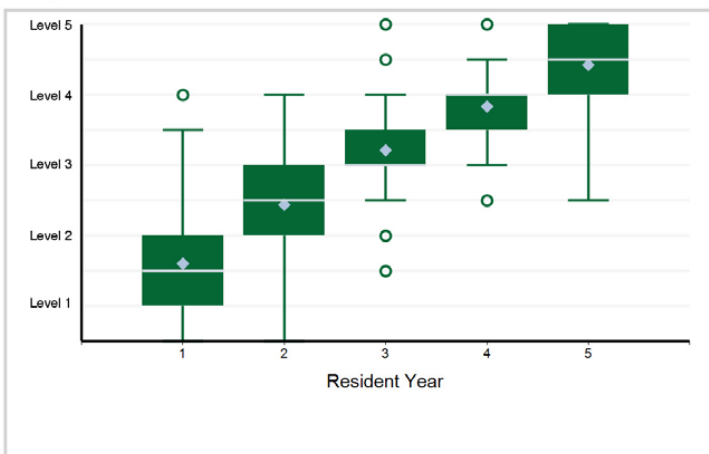

11. Systems-Based Practice - Systems-Based Practice 3: Physician Role in Health Care Systems

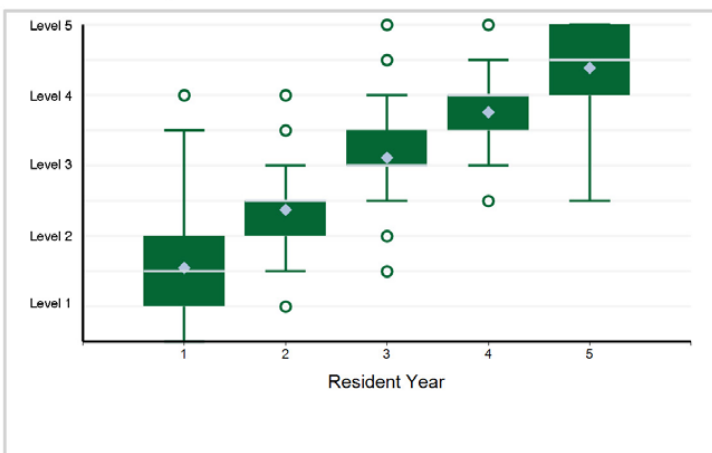

12. Practice-Based Learning and Improvement - Practice-Based Learning and Improvement 1: Evidence-Based and Informed Practice

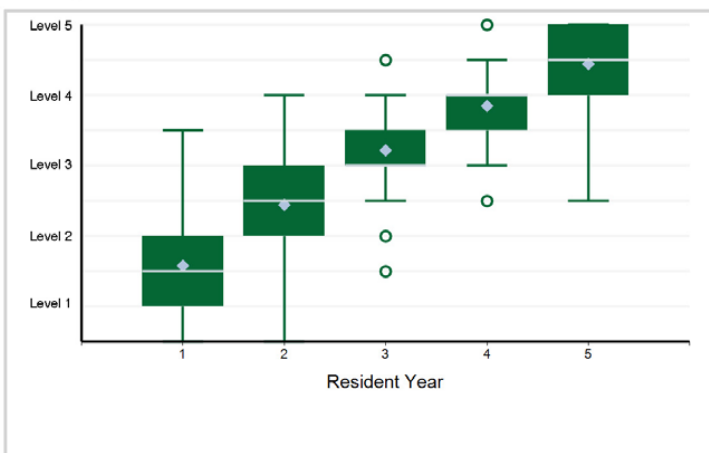

Specialty Box Plot Report - Milestone Evaluation by Resident Year: Year-End 2021-2022

SPECIALTY: Urology

13. Practice-Based Learning and Improvement - Practice-Based Learning and Improvement 2: Reflective Practice and Commitment ...

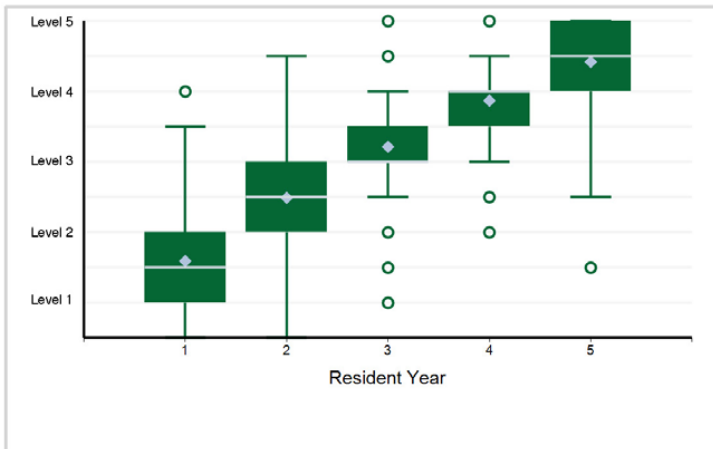

14. Professionalism - Professionalism 1: Professional Behavior and Ethical Principles

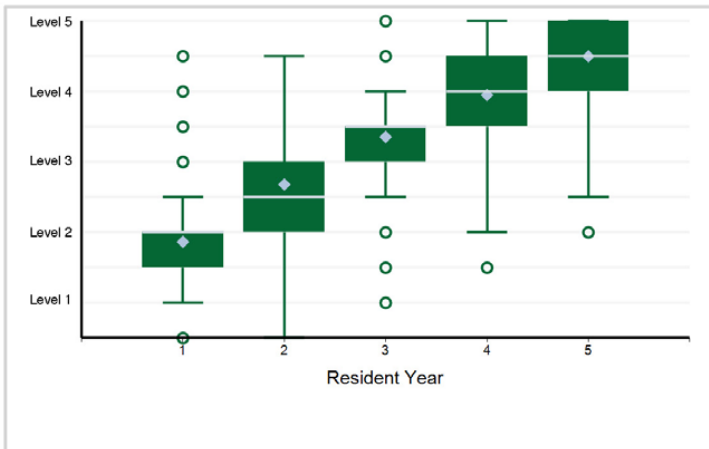

15. Professionalism - Professionalism 2: Administrative Tasks

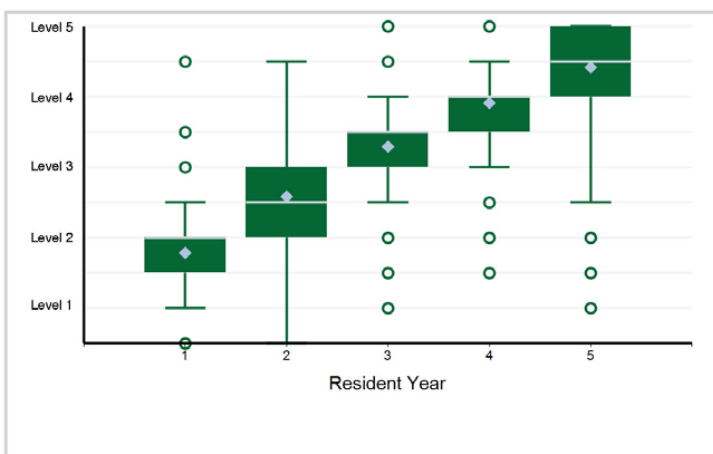

16. Professionalism - Professionalism 3: Well-Being and Awareness

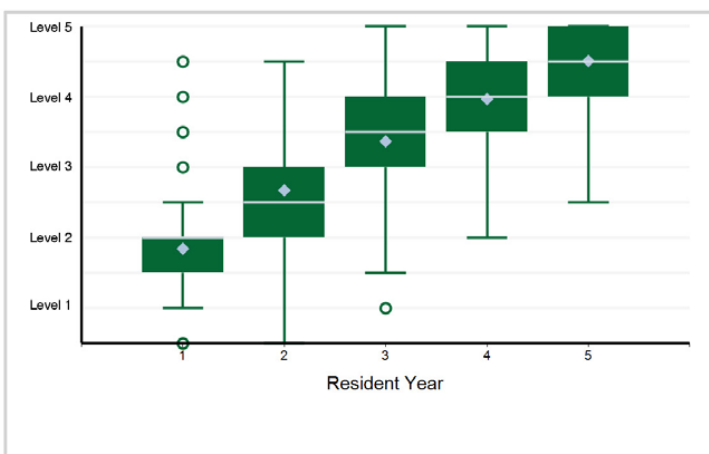

17. Interpersonal and Communication Skills - Interpersonal and Communication Skills 1: Patient- and Family-Centered Communication

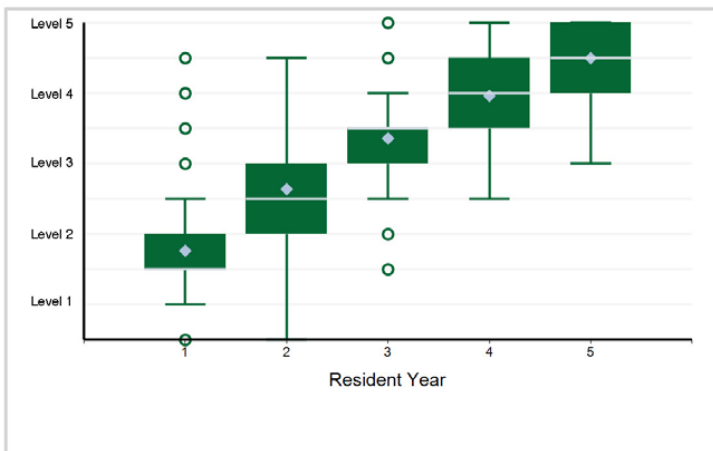

18. Interpersonal and Communication Skills - Interpersonal and Communication Skills 2: Patient Counseling ...

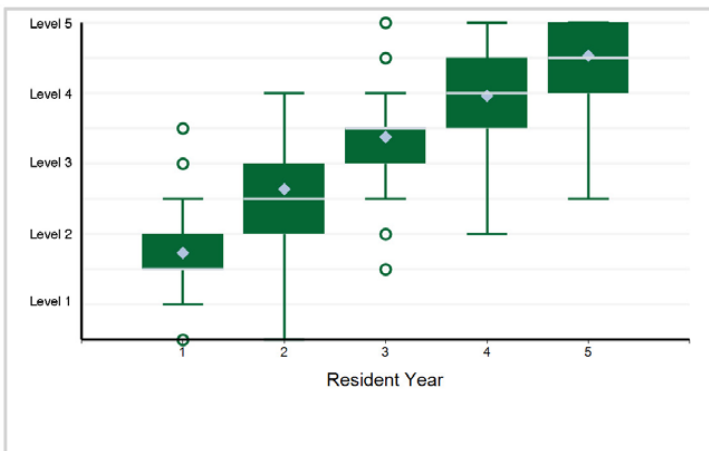

Specialty Box Plot Report - Milestone Evaluation by Resident Year: Year-End 2021-2022

SPECIALTY: **Urology**

19. Interpersonal and Communication Skills - Interpersonal and Communication Skills 3: Interprofessional and Team Communication

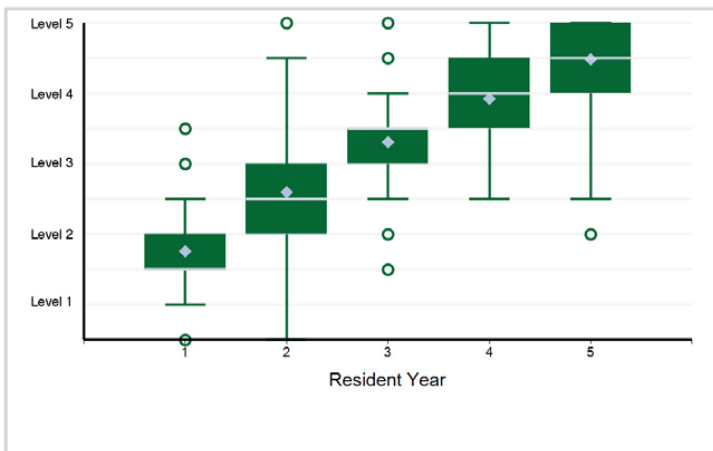

20. Interpersonal and Communication Skills - Interpersonal and Communication Skills 4: Communication within Health Care Systems

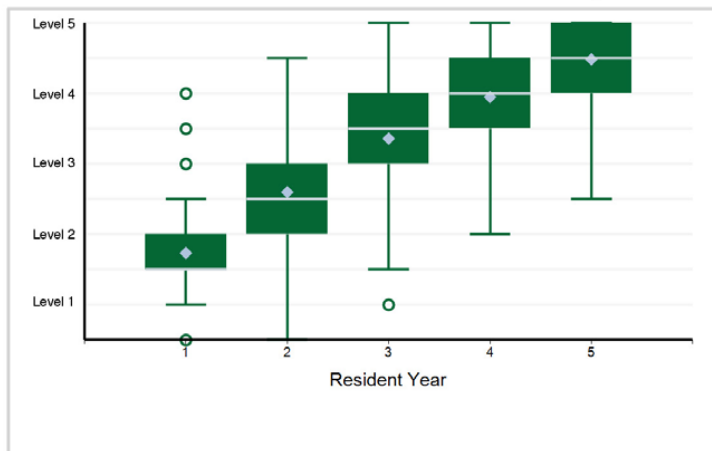

Specialty Box Plot Report - Milestone Evaluation by Resident Year: Year-End 2021-2022

TABLE 150: SUBSPECIALTY: Female Pelvic Medicine and Reconstructive Surgery (multidisciplinary, Urology)

Resident Year	1	2	3	Total Residents
# of Residents	15	15	7	37

1. Patient Care - General Pelvic Floor Evaluation — Patient Care

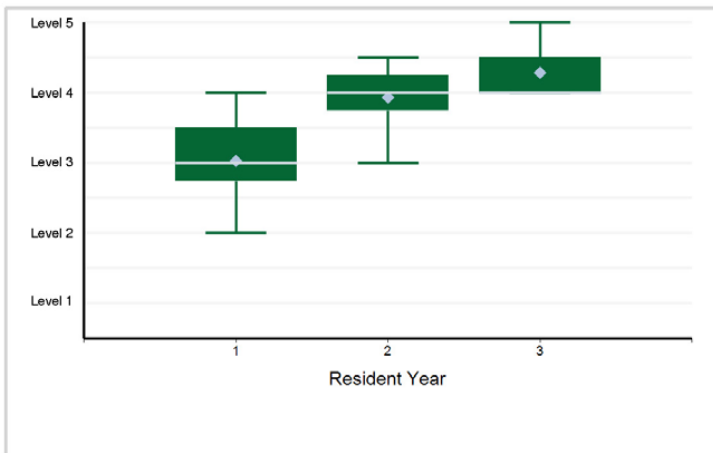

2. Patient Care - Urinary Incontinence and Overactive Bladder Treatment — Patient Care

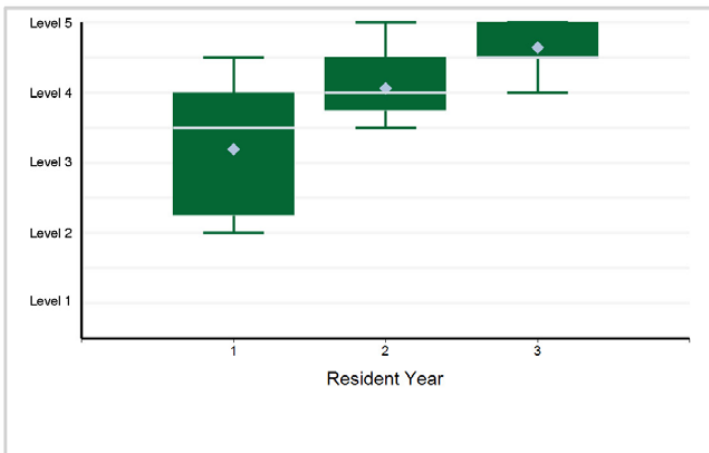

3. Patient Care - Anal Incontinence and Defecatory Dysfunction Treatment — Patient Care

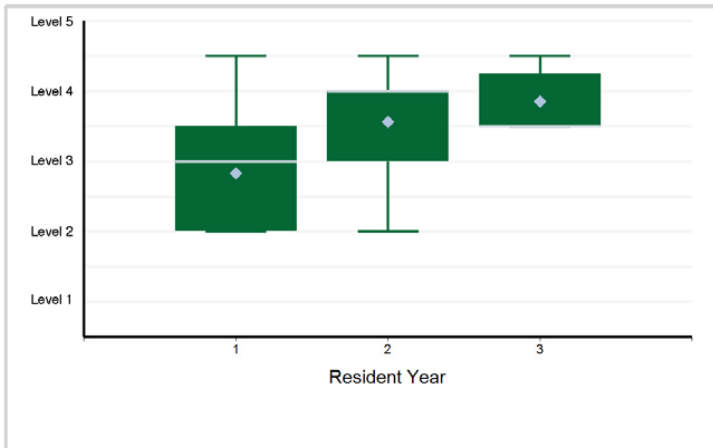

4. Patient Care - Pelvic Organ Prolapse Treatment — Patient Care

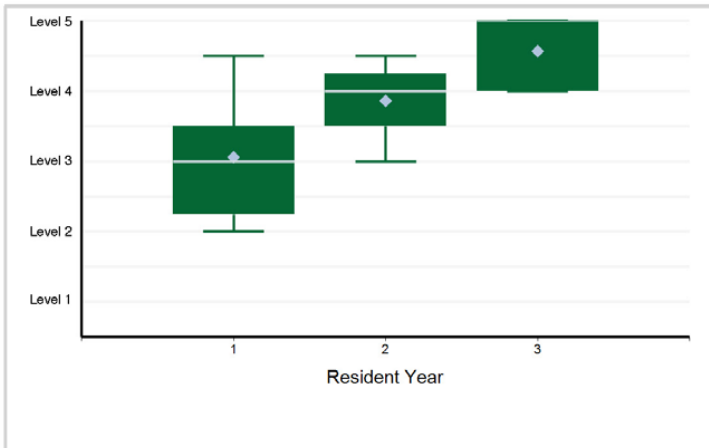

5. Patient Care - Urogenital Fistulas and Urethral Diverticula Treatment — Patient Care

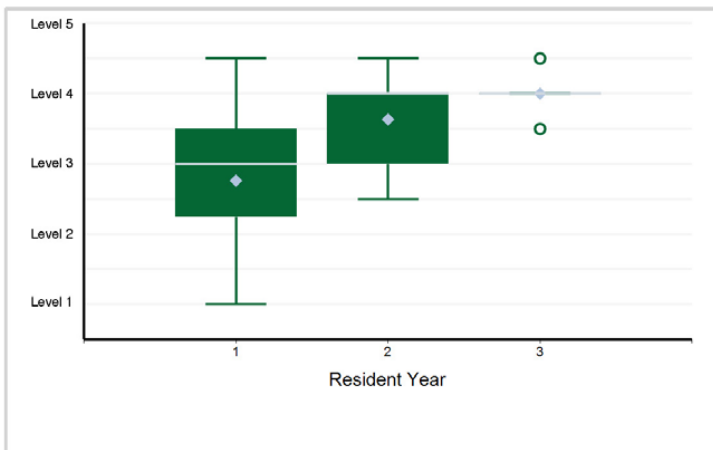

6. Patient Care - Painful Bladder Syndrome Treatment — Patient Care

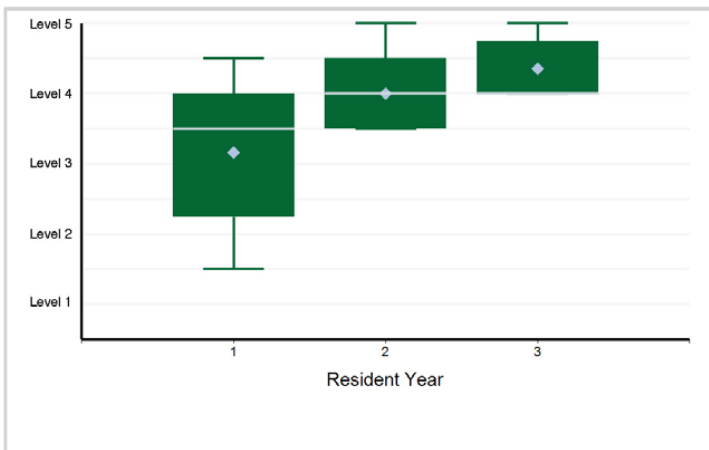

Specialty Box Plot Report - Milestone Evaluation by Resident Year: Year-End 2021-2022

SUBSPECIALTY: Female Pelvic Medicine and Reconstructive Surgery (multidisciplinary, Urology)

7. Patient Care - Urinary Tract Infection (UTI) — Patient Care

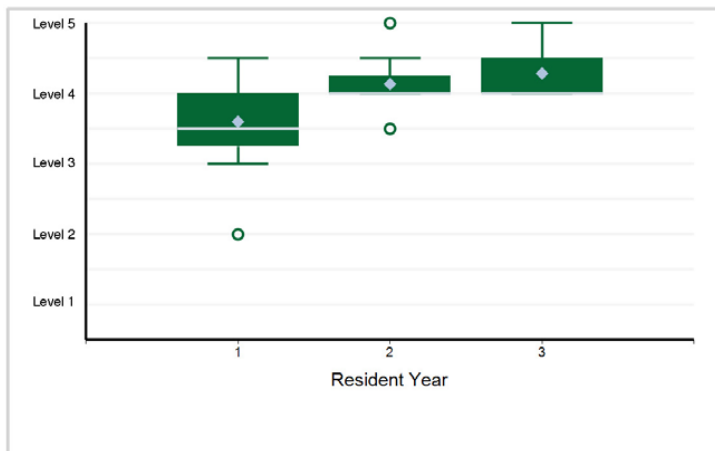

8. Medical Knowledge - Pelvic Floor Anatomy and Physiology — Medical Knowledge

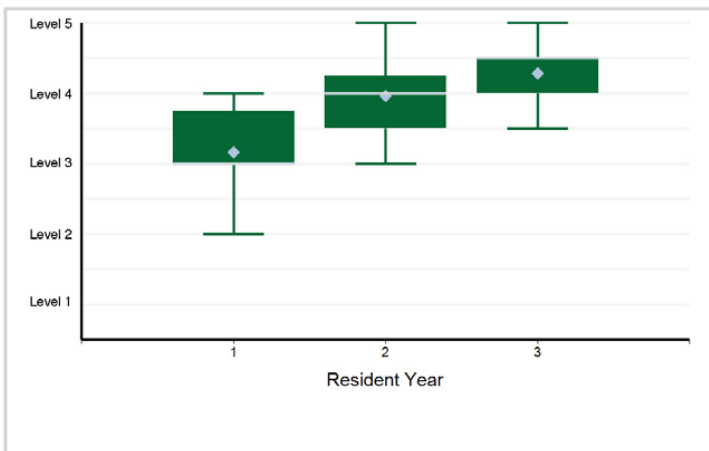

9. Medical Knowledge - Urinary Incontinence and Overactive Bladder Treatment — Medical Knowledge

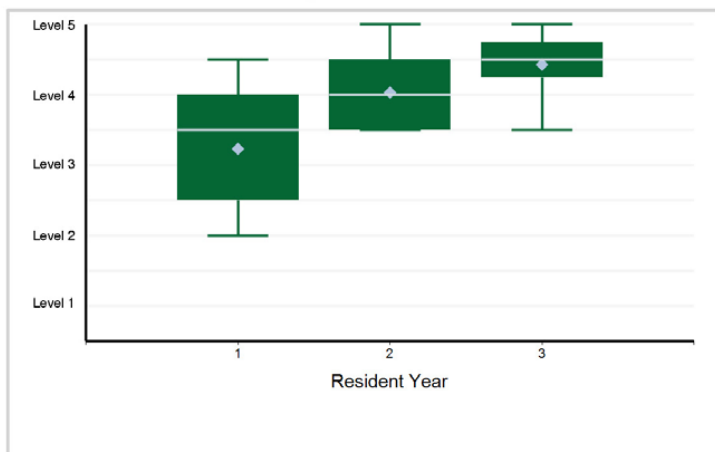

10. Medical Knowledge - Anal Incontinence and Defecatory Dysfunction Treatment — Medical Knowledge

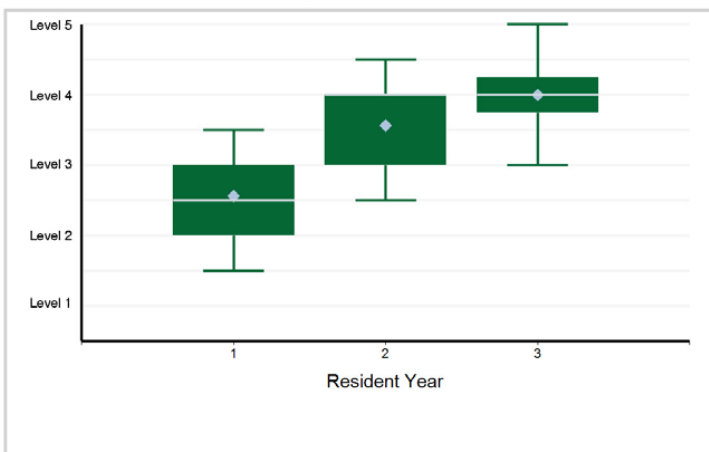

11. Medical Knowledge - Pelvic Organ Prolapse Treatment — Medical Knowledge

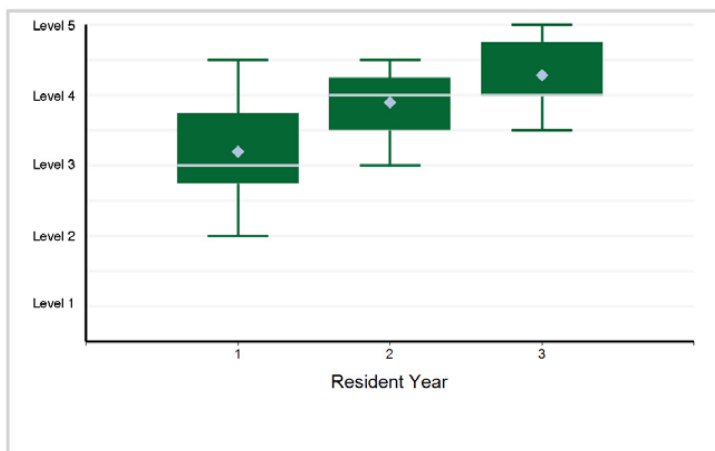

12. Medical Knowledge - Urogenital Fistulas and Urethral Diverticula Treatment — Medical Knowledge

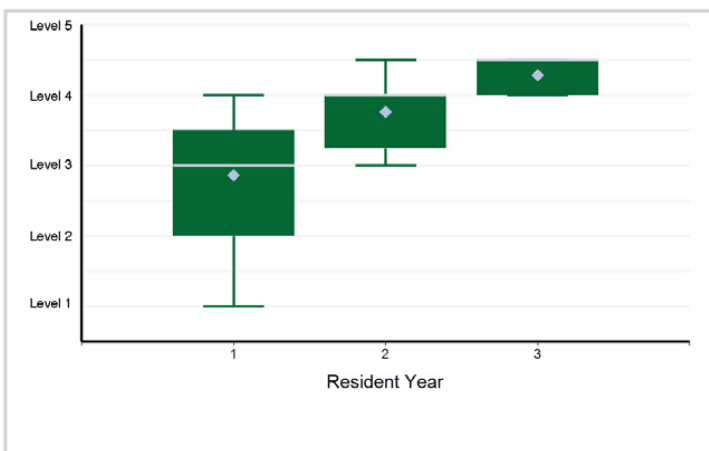

Specialty Box Plot Report - Milestone Evaluation by Resident Year: Year-End 2021-2022

SUBSPECIALTY: Female Pelvic Medicine and Reconstructive Surgery (multidisciplinary, Urology)

13. Medical Knowledge - Painful Bladder Syndrome Treatment — Medical Knowledge

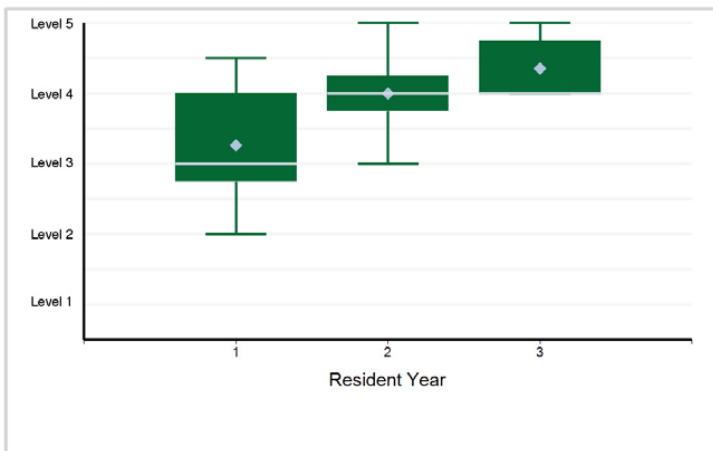

14. Medical Knowledge - Urinary Tract Infection — Medical Knowledge

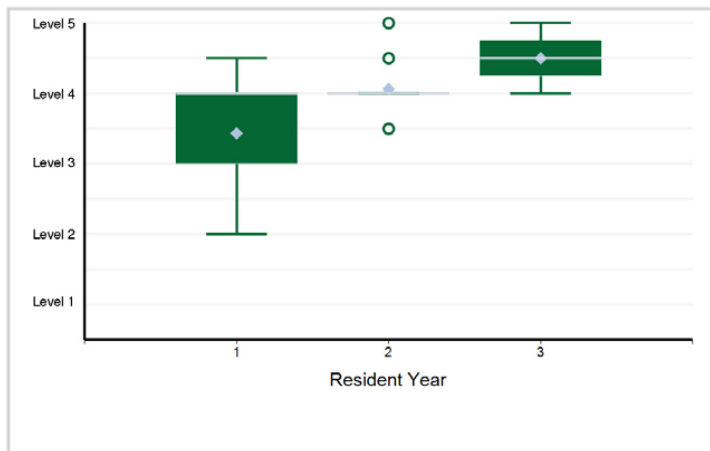

15. Medical Knowledge - Neuro-Urology — Medical Knowledge

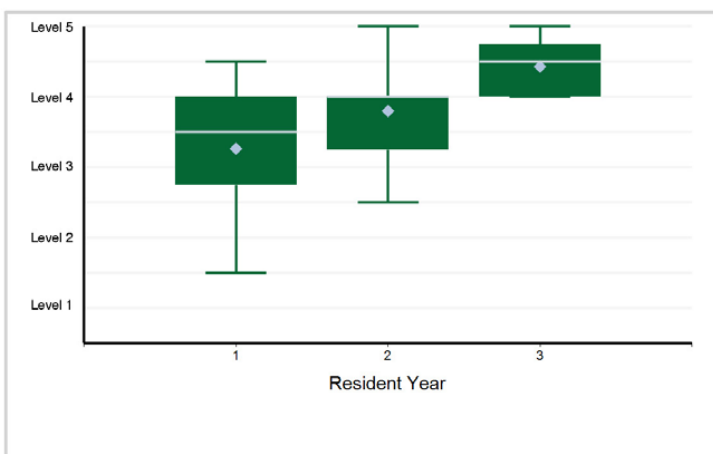

16. Systems-Based Practice - Computer Systems — Systems-Based Practice

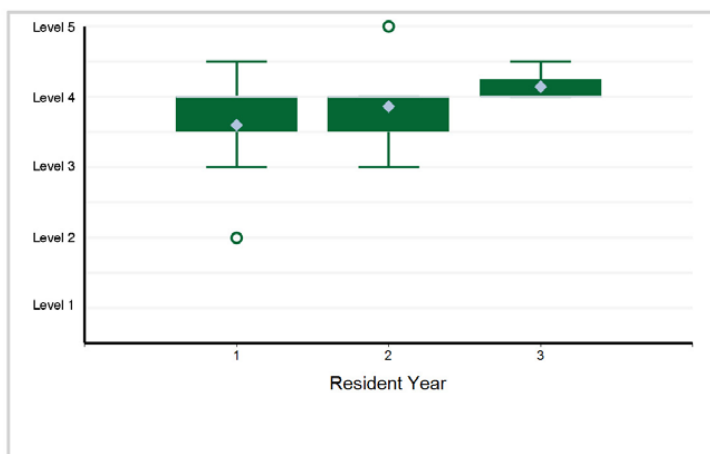

17. Systems-Based Practice - Health Care Economics — Systems-Based Practice

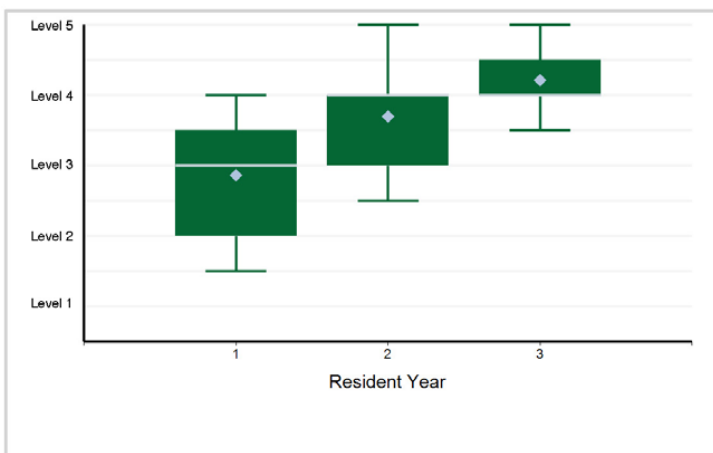

18. Systems-Based Practice - Works and coordinates patient care effectively in various health care delivery ...

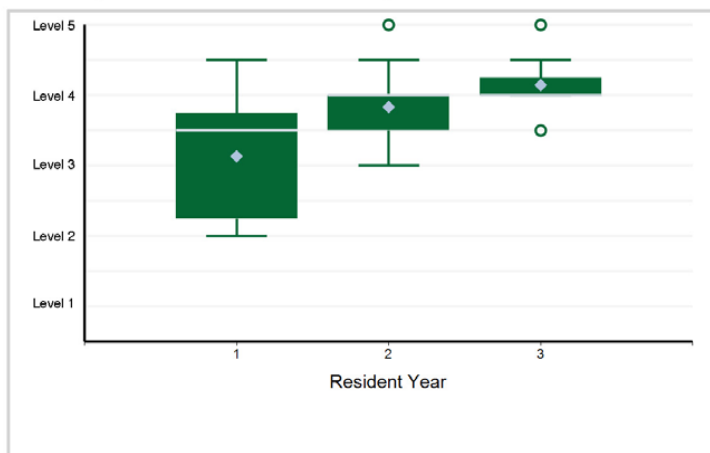

Specialty Box Plot Report - Milestone Evaluation by Resident Year: Year-End 2021-2022

SUBSPECIALTY: Female Pelvic Medicine and Reconstructive Surgery (multidisciplinary, Urology)

19. Practice-Based Learning and Improvement - Scholarly Activity — Practice-Based Learning and Improvement

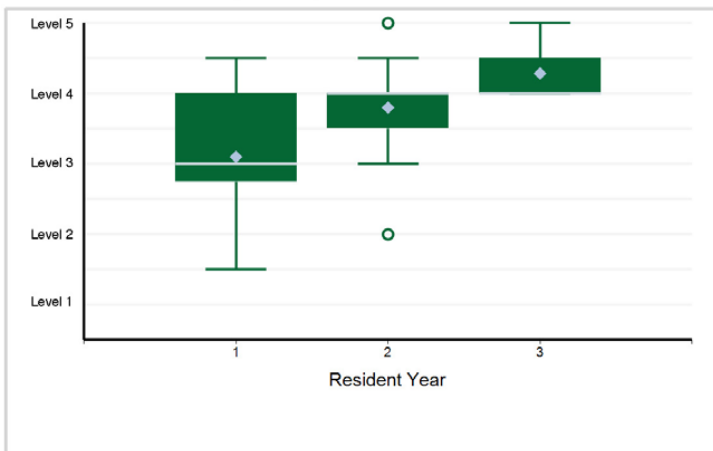

20. Practice-Based Learning and Improvement - Implements Quality Improvement Project — Practice-Based Learning and Improvement

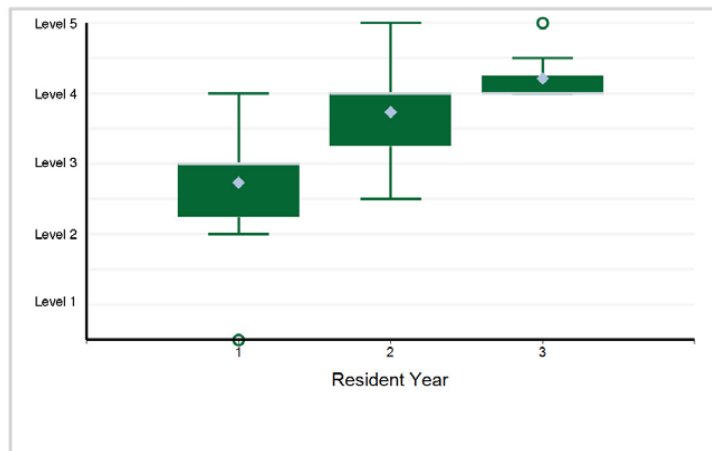

21. Professionalism - Professional Ethics and Accountability — Professionalism

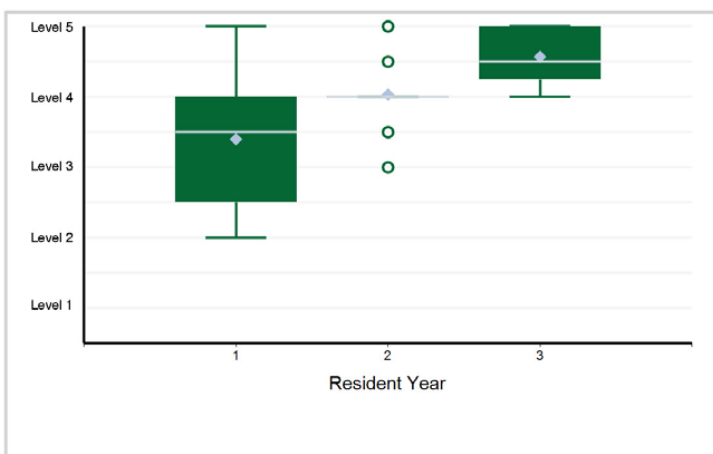

22. Interpersonal and Communication Skills - Health Care Teamwork — Interpersonal and Communication Skills

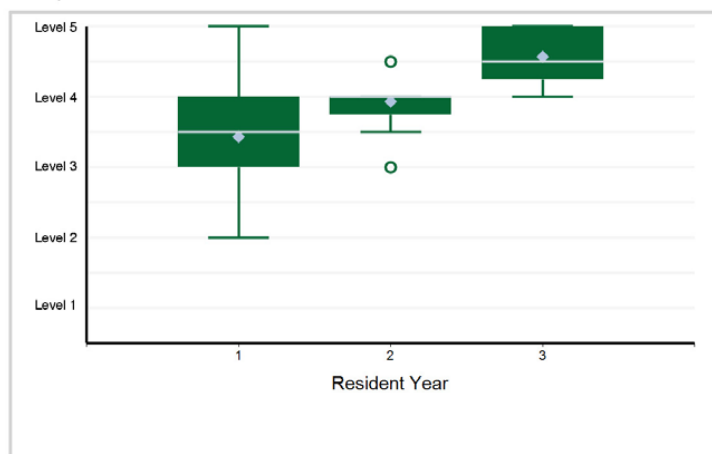

23. Interpersonal and Communication Skills - Effective Communication — Interpersonal and Communication Skills

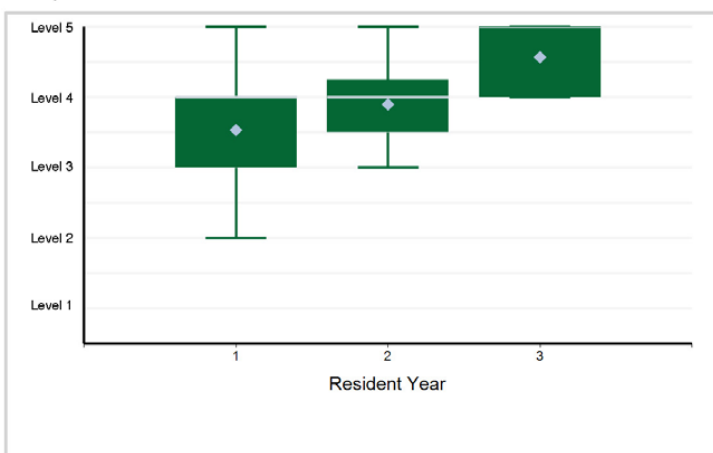

Specialty Box Plot Report - Milestone Evaluation by Resident Year: Year-End 2021-2022

TABLE 151: SUBSPECIALTY: **Pediatric Urology**

Resident Year	1	2	Total Residents
# of Residents	18	11	29

1. Patient Care - Patient Care 1: Patient Evaluation and Decision Making

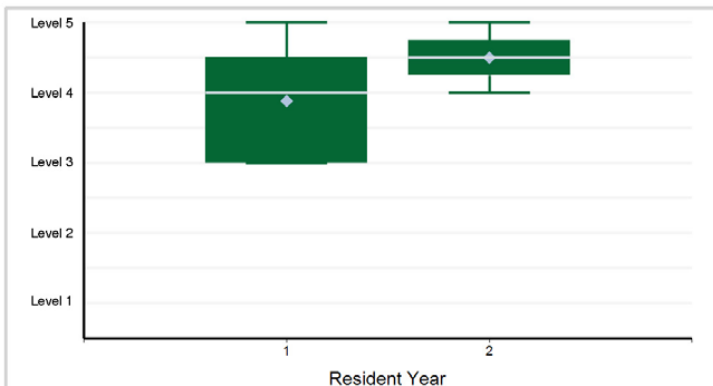

Note: 5 of 29 residents have a status of "Not Yet Assessable" and are not included in the analysis.

2. Patient Care - Patient Care 2: Peri-Procedural Care

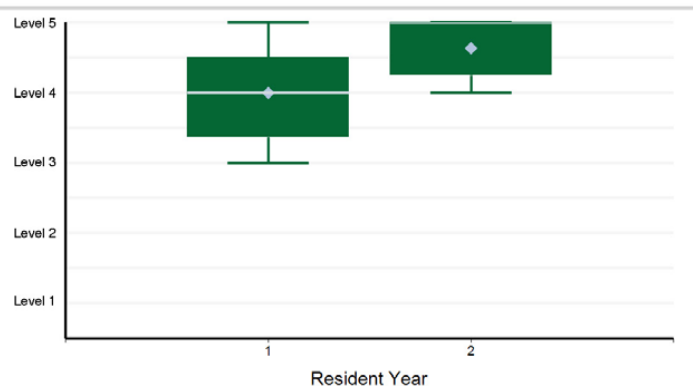

Note: 6 of 29 residents have a status of "Not Yet Assessable" and are not included in the analysis.

3. Patient Care - Patient Care 3: Endoscopic Procedures

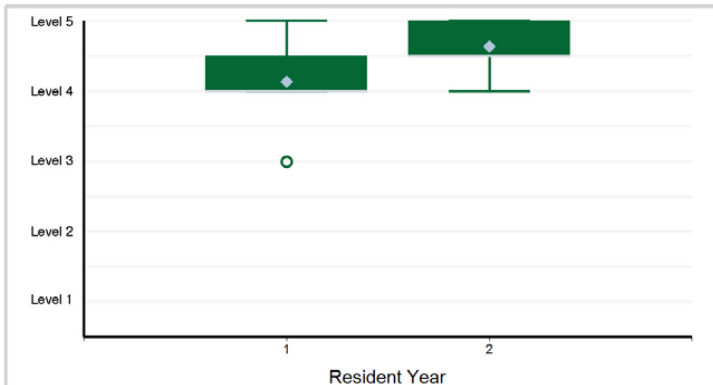

Note: 7 of 29 residents have a status of "Not Yet Assessable" and are not included in the analysis.

4. Patient Care - Patient Care 4: Open Procedures – Abdominal and Retroperitoneal

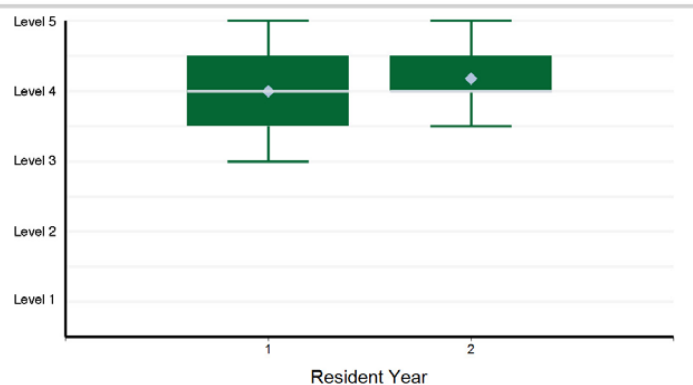

Note: 7 of 29 residents have a status of "Not Yet Assessable" and are not included in the analysis.

5. Patient Care - Patient Care 5: Genital Reconstruction

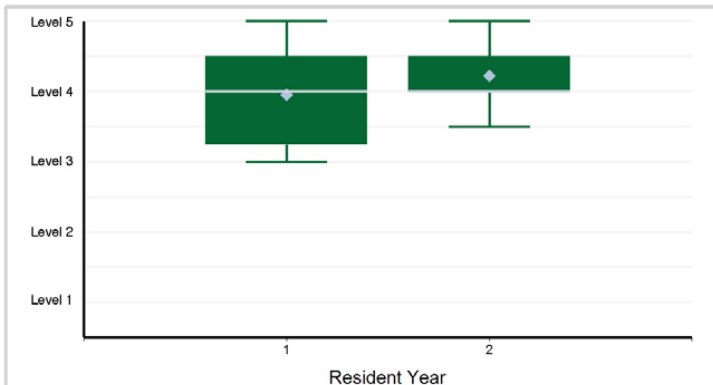

Note: 7 of 29 residents have a status of "Not Yet Assessable" and are not included in the analysis.

6. Patient Care - Patient Care 6: Minimally Invasive Procedures (Laparoscopic and Robotic)

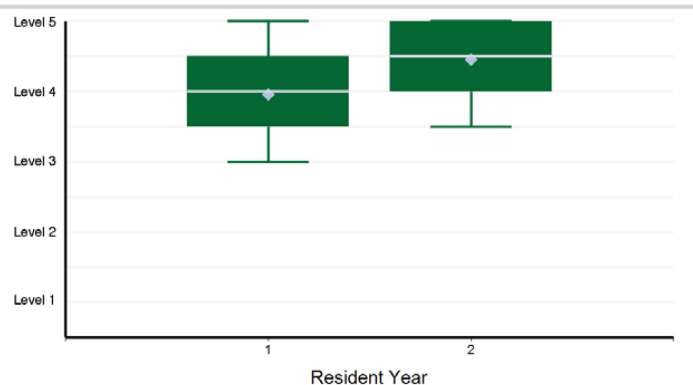

Note: 5 of 29 residents have a status of "Not Yet Assessable" and are not included in the analysis.

Specialty Box Plot Report - Milestone Evaluation by Resident Year: Year-End 2021-2022

SUBSPECIALTY: Pediatric Urology

7. Medical Knowledge - Medical Knowledge 1: Clinical Medical Knowledge

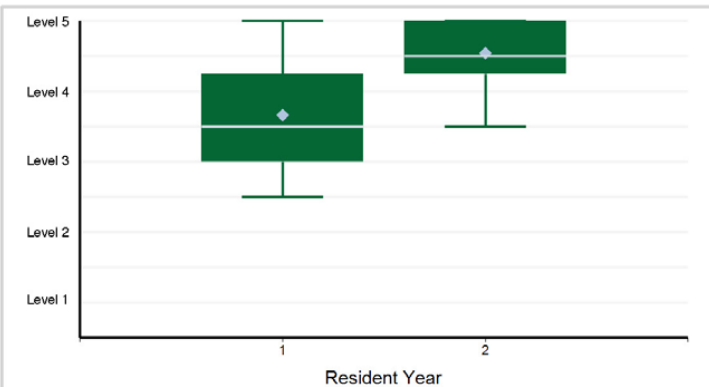

Note: 3 of 29 residents have a status of "Not Yet Assessable" and are not included in the analysis.

8. Medical Knowledge - Medical Knowledge 2: Clinical Reasoning

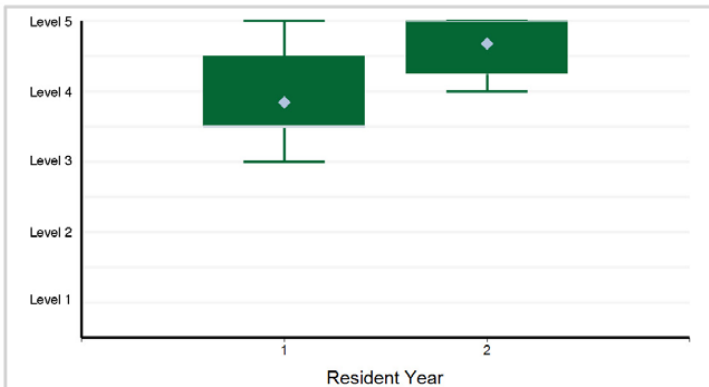

Note: 5 of 29 residents have a status of "Not Yet Assessable" and are not included in the analysis.

9. Medical Knowledge - Medical Knowledge 3: Complex Care in Medical Management

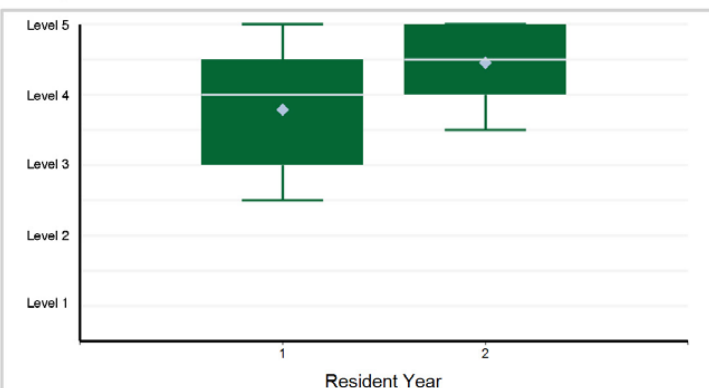

Note: 6 of 29 residents have a status of "Not Yet Assessable" and are not included in the analysis.

10. Systems-Based Practice - Systems-Based Practice 1: Patient Safety and Quality Improvement

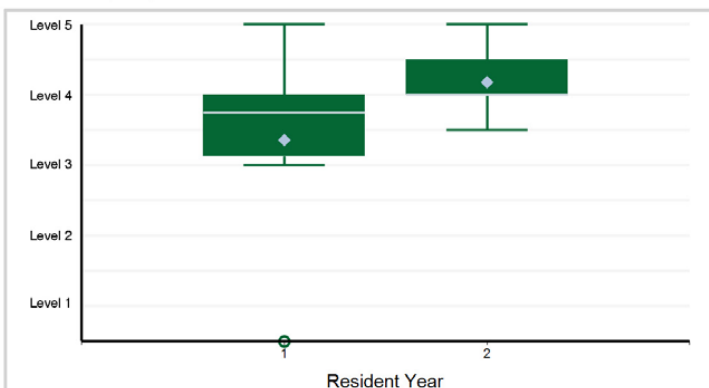

11. Systems-Based Practice - Systems-Based Practice 2: System Navigation for Patient-Centered Care

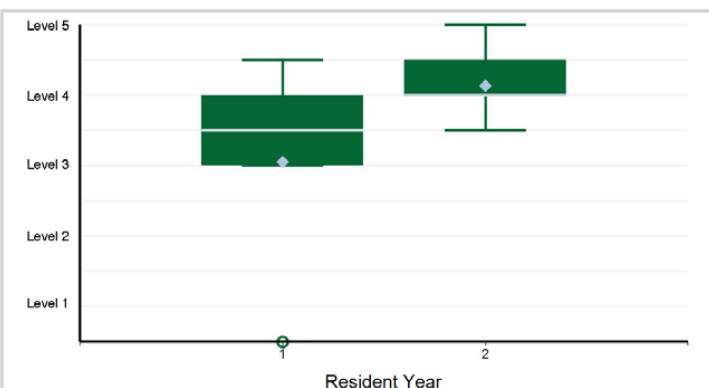

12. Systems-Based Practice - Systems-Based Practice 3: Physician Role in Health Care Systems

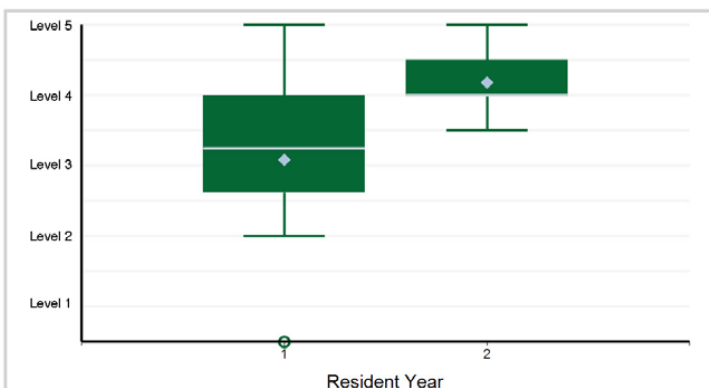

Specialty Box Plot Report - Milestone Evaluation by Resident Year: Year-End 2021-2022

SUBSPECIALTY: Pediatric Urology

13. Practice-Based Learning and Improvement - Practice-Based Learning and Improvement 1: Evidence-Based and Informed Practice

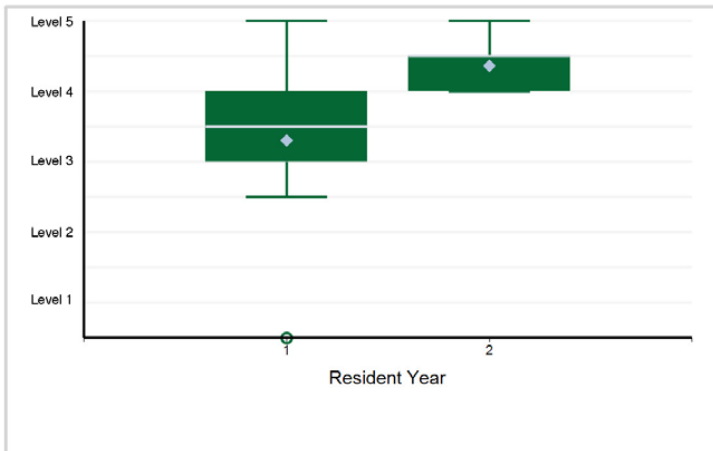

14. Practice-Based Learning and Improvement - Practice-Based Learning and Improvement 2: Reflective Practice and Commitment ...

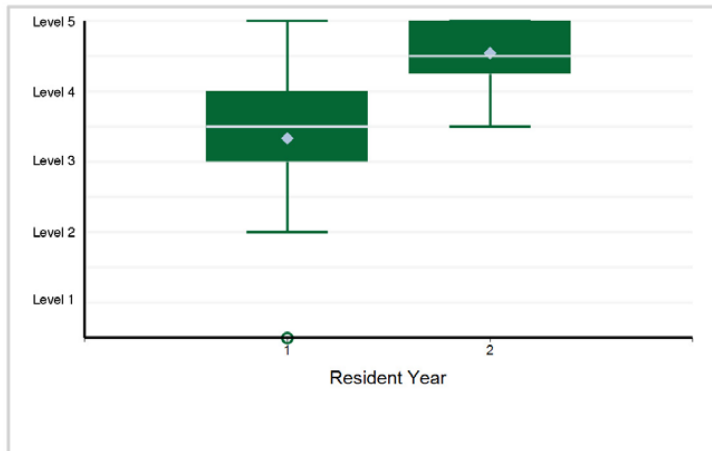

15. Professionalism - Professionalism 1: Professional Behavior and Ethical Principles

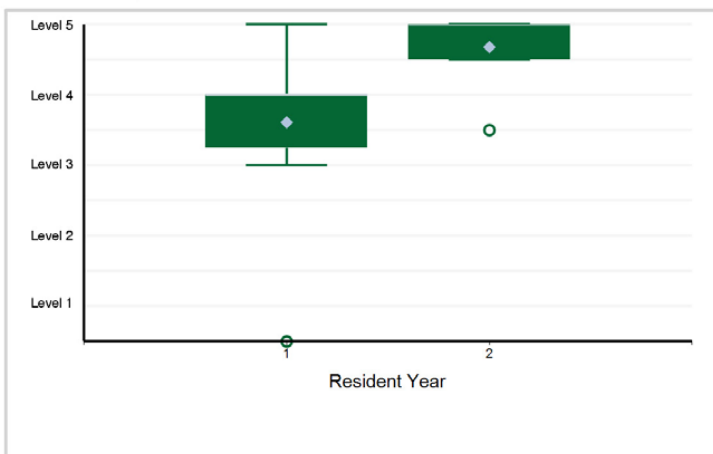

16. Professionalism - Professionalism 2: Administrative Tasks

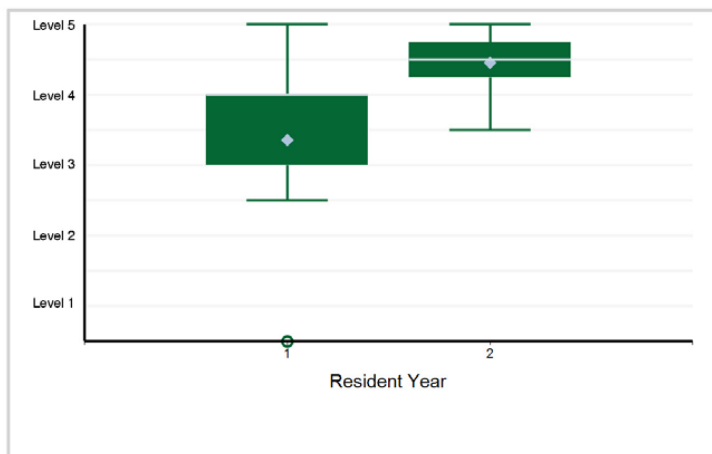

17. Professionalism - Professionalism 3: Well-Being

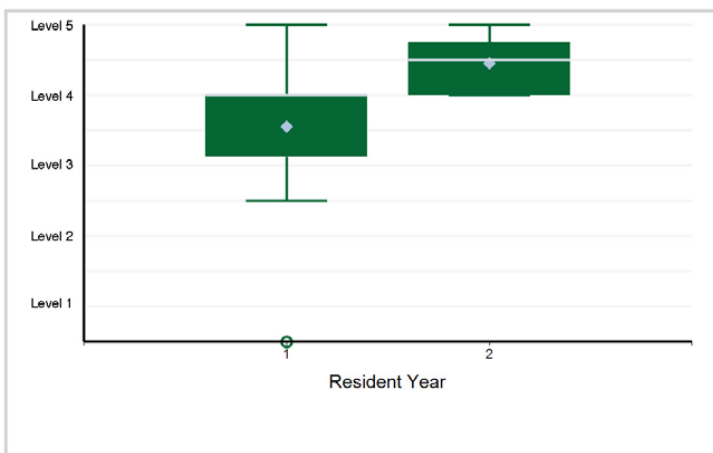

18. Interpersonal and Communication Skills - Interpersonal and Communication Skills 1: Patient- and Family-Centered Communication

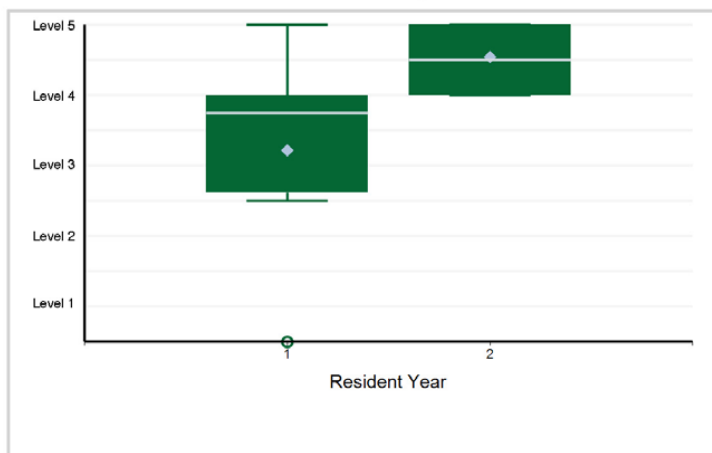

Specialty Box Plot Report - Milestone Evaluation by Resident Year: Year-End 2021-2022

SUBSPECIALTY: Pediatric Urology

19. Interpersonal and Communication Skills - Interpersonal and Communication Skills 2: Patient Counseling ...

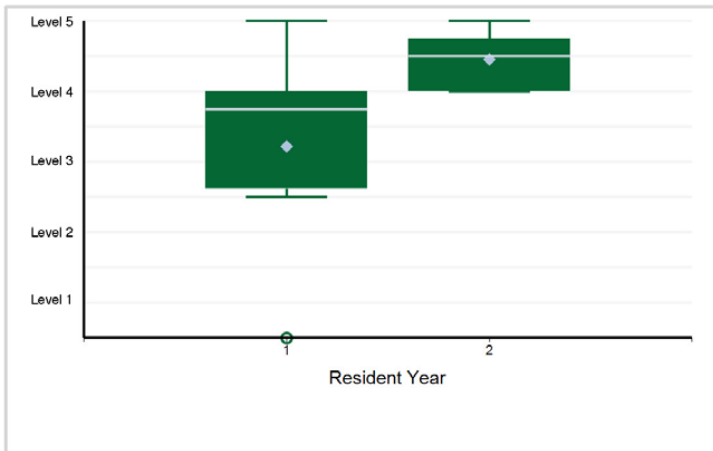

20. Interpersonal and Communication Skills - Interpersonal and Communication Skills 3: Interprofessional and Team Communication

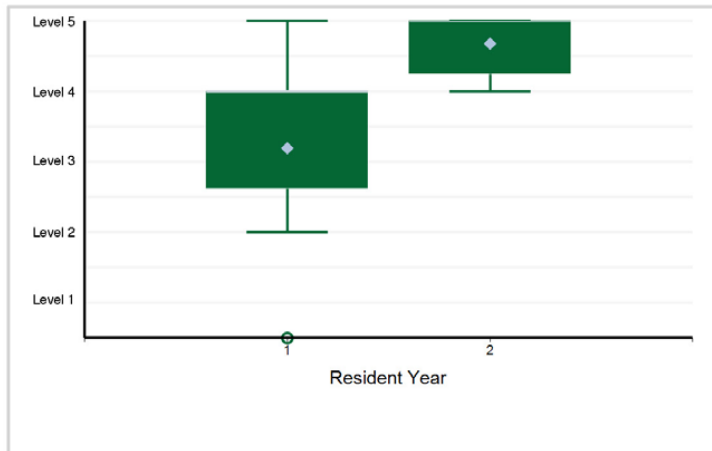

21. Interpersonal and Communication Skills - Interpersonal and Communication Skills 4: Communication within Health Care Systems

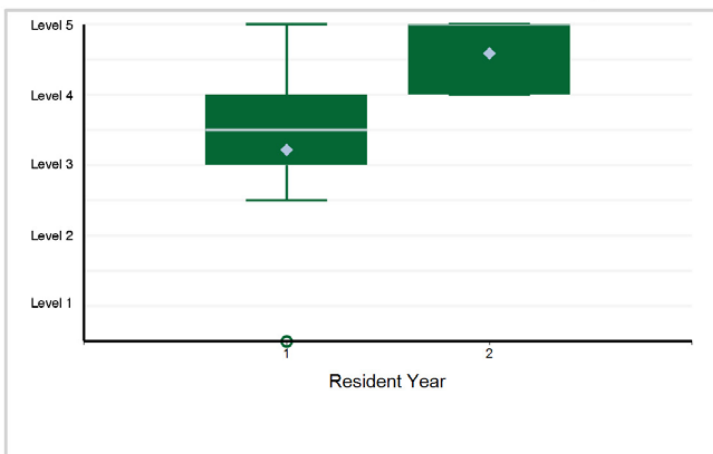

Specialty Box Plot Report - Milestone Evaluation by Resident Year: Year-End 2021-2022

TABLE 152: SPECIALTY: **Internal Medicine - Pediatrics**

Resident Year	1	2	3	4	Total Residents
# of Residents	390	389	377	378	1,534

Internal Medicine

1. Patient Care - Patient Care 1: History

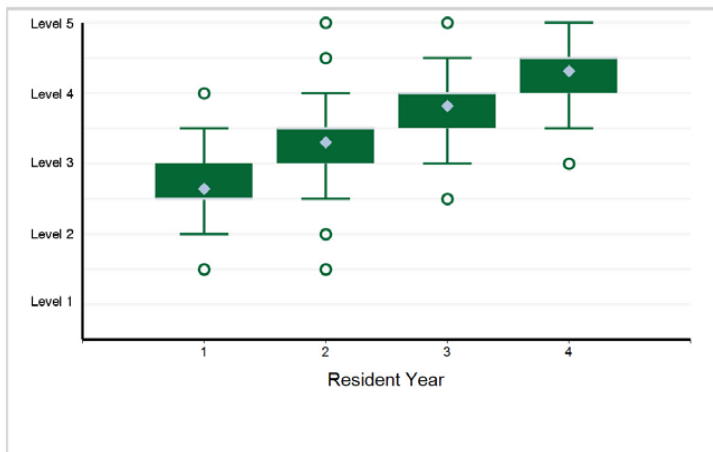

2. Patient Care - Patient Care 2: Physical Examination

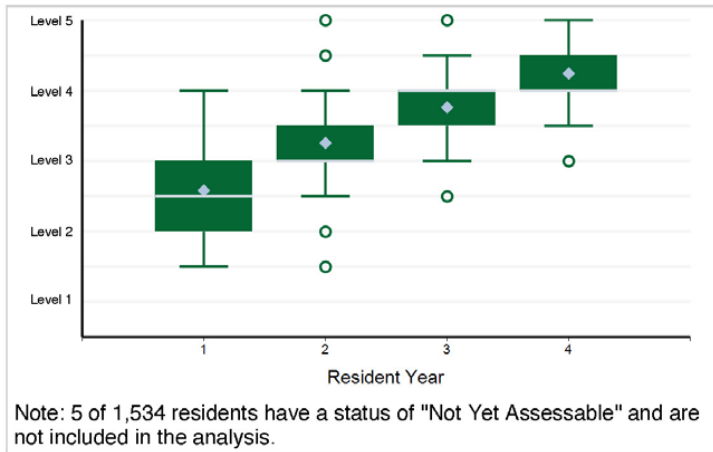

3. Patient Care - Patient Care 3: Clinical Reasoning

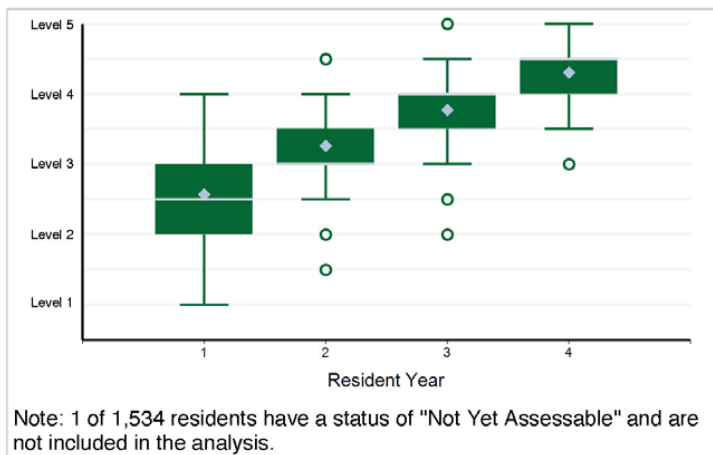

4. Patient Care - Patient Care 4: Patient Management – Inpatient

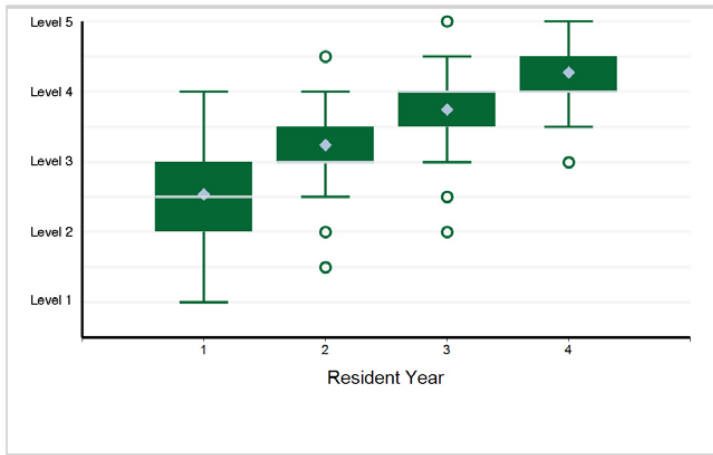

5. Patient Care - Patient Care 5: Patient Management – Outpatient

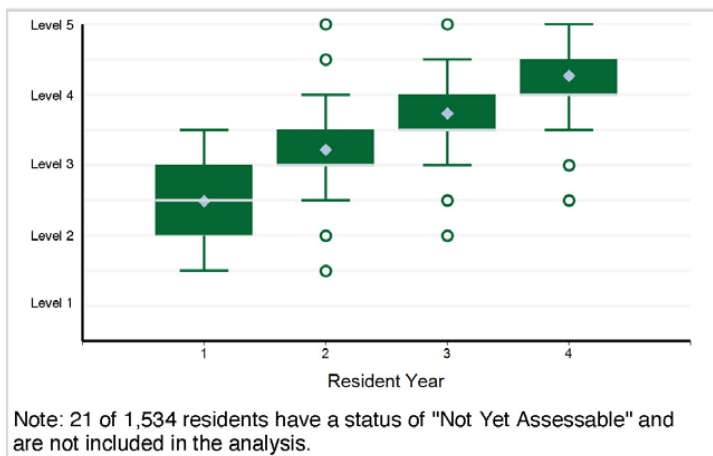

6. Patient Care - Patient Care 6: Digital Health

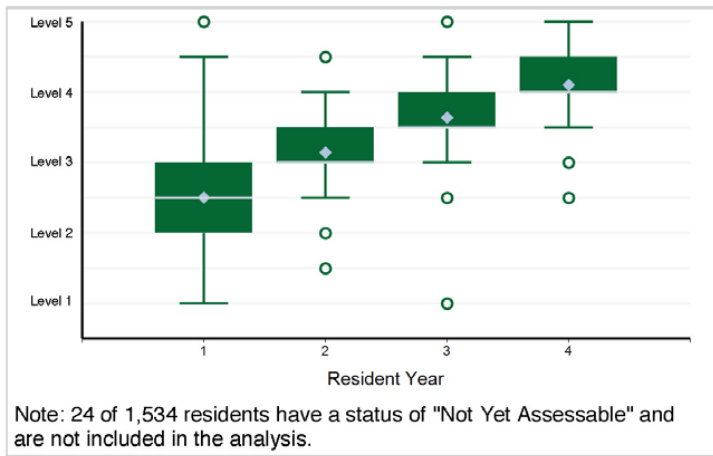

Specialty Box Plot Report - Milestone Evaluation by Resident Year: Year-End 2021-2022

SPECIALTY: **Internal Medicine - Pediatrics**

Internal Medicine

7. Medical Knowledge - Medical Knowledge 1: Applied Foundational Sciences

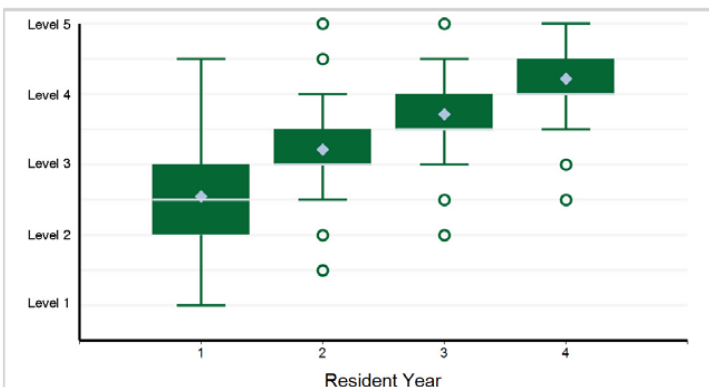

Note: 5 of 1,534 residents have a status of "Not Yet Assessable" and are not included in the analysis.

8. Medical Knowledge - Medical Knowledge 2: Therapeutic Knowledge

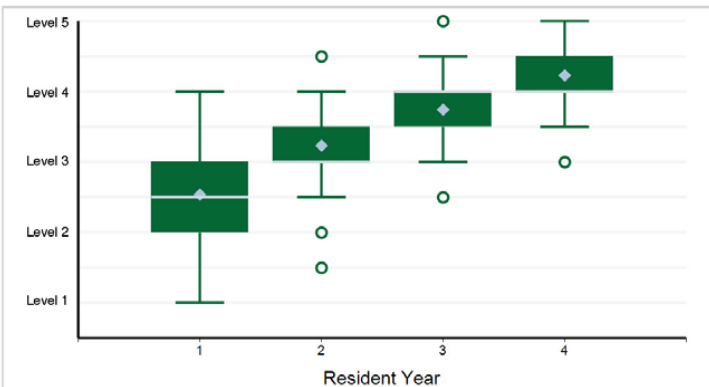

9. Medical Knowledge - Medical Knowledge 3: Knowledge of Diagnostic Testing

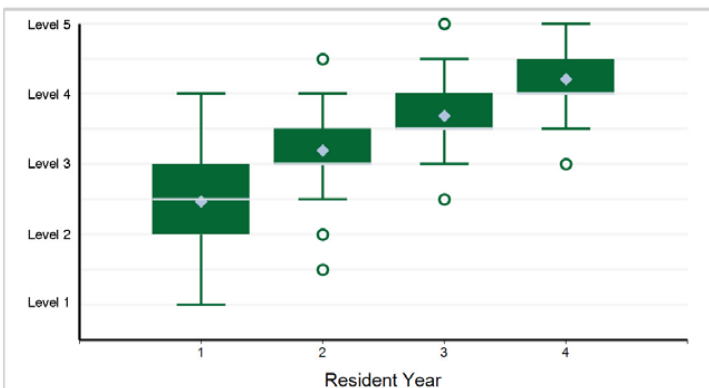

Note: 1 of 1,534 residents have a status of "Not Yet Assessable" and are not included in the analysis.

10. Systems-Based Practice - Systems-Based Practice 1: Patient Safety and Quality Improvement

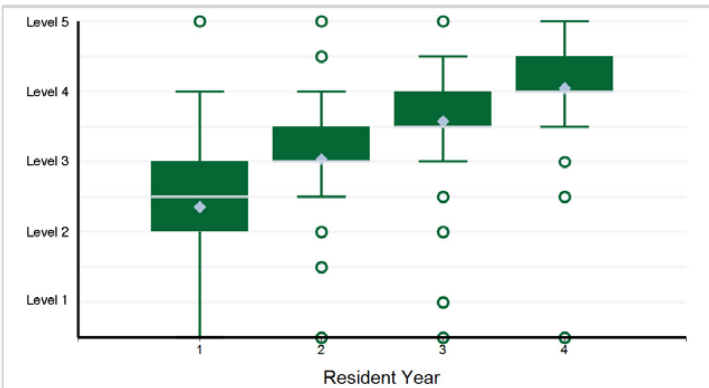

11. Systems-Based Practice - Systems-Based Practice 2: System Navigation for Patient-Centered Care

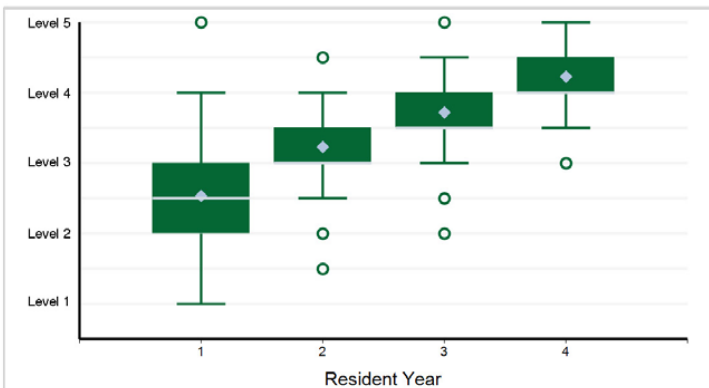

12. Systems-Based Practice - Systems-Based Practice 3: Physician Role in Health Care Systems

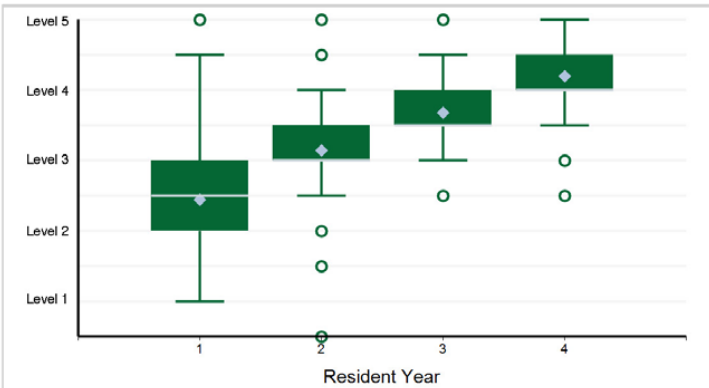

Specialty Box Plot Report - Milestone Evaluation by Resident Year: Year-End 2021-2022

SPECIALTY: **Internal Medicine - Pediatrics**

Internal Medicine

13. Practice-Based Learning and Improvement - Practice-Based Learning and Improvement 1: Evidence-Based and Informed Practice

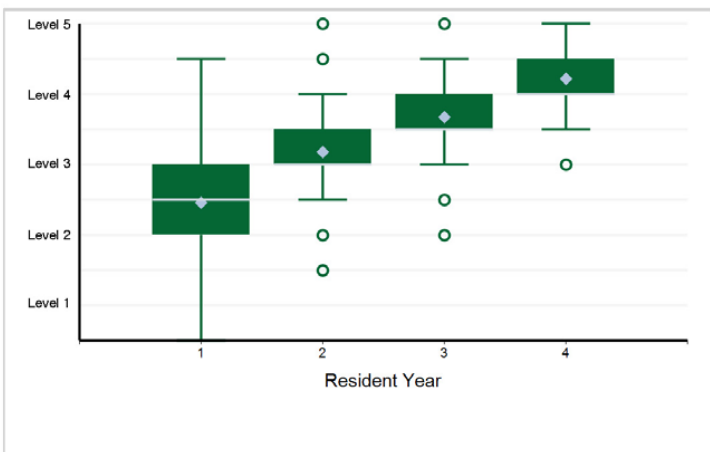

14. Practice-Based Learning and Improvement - Practice-Based Learning and Improvement 2: Reflective Practice and Commitment ...

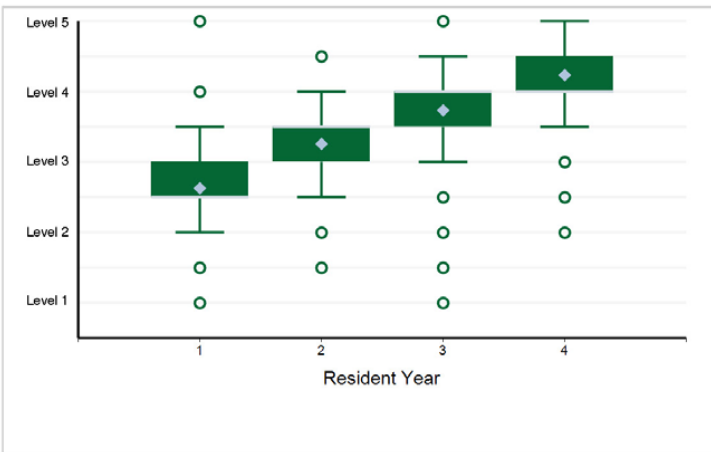

15. Professionalism - Professionalism 1: Professional Behavior

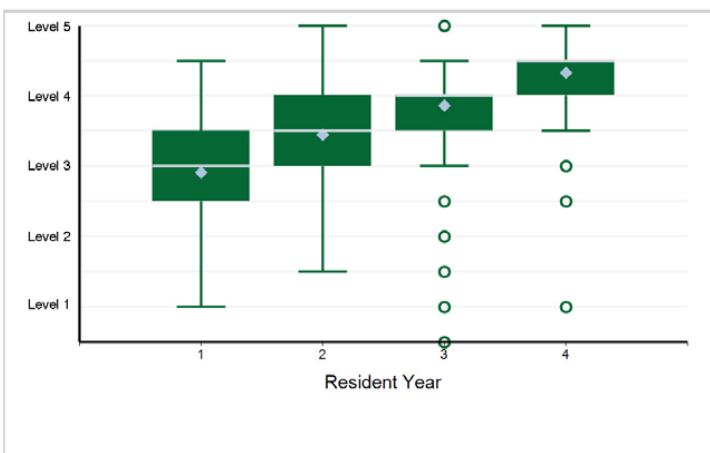

16. Professionalism - Professionalism 2: Ethical Principles

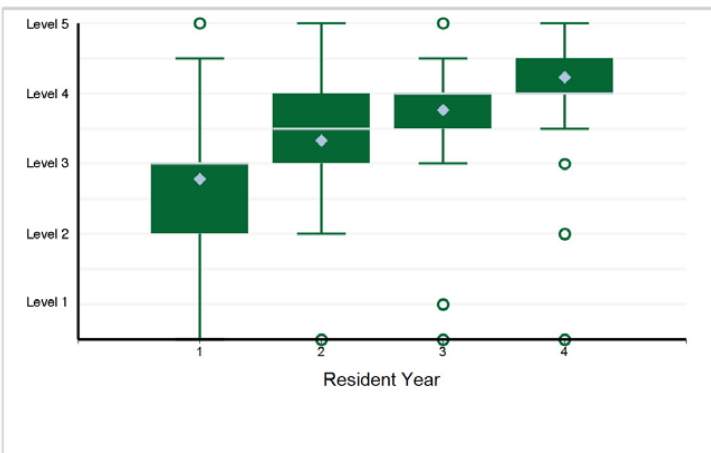

17. Professionalism - Professionalism 3: Accountability/Conscientiousness

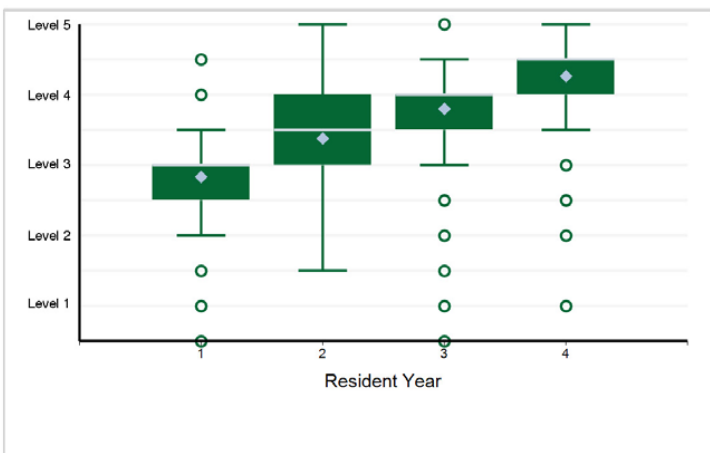

18. Professionalism - Professionalism 4: Knowledge of Systemic and Individual Factors of Well-Being* *This subcompetency is ...

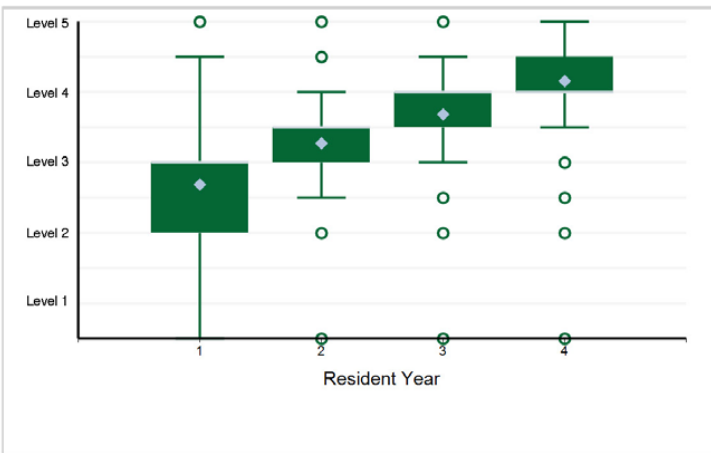

Specialty Box Plot Report - Milestone Evaluation by Resident Year: Year-End 2021-2022

SPECIALTY: **Internal Medicine - Pediatrics**

Internal Medicine

19. Interpersonal and Communication Skills - Interpersonal and Communication Skills 1: Patient- and Family-Centered Communication

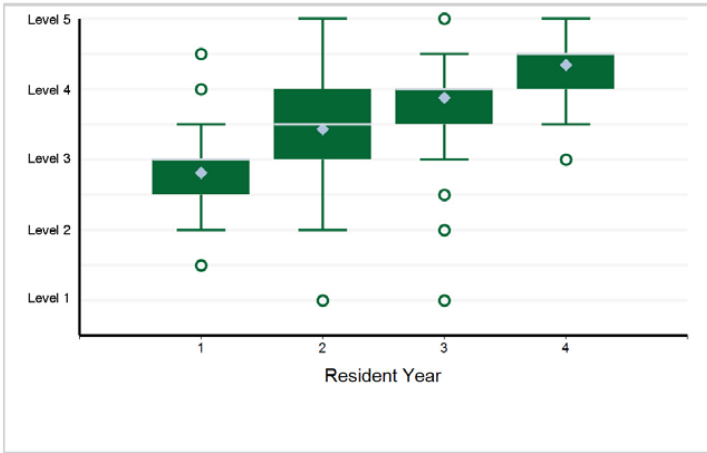

20. Interpersonal and Communication Skills - Interpersonal and Communication Skills 2: Interprofessional and Team Communication

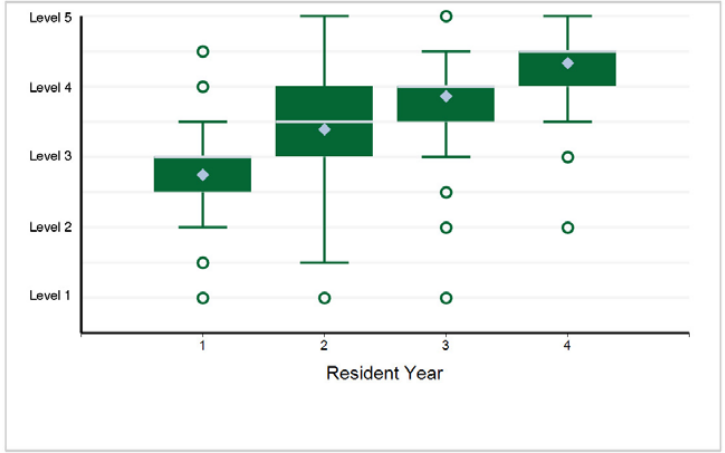

21. Interpersonal and Communication Skills - Interpersonal and Communication Skills 3: Communication within Health Care Systems

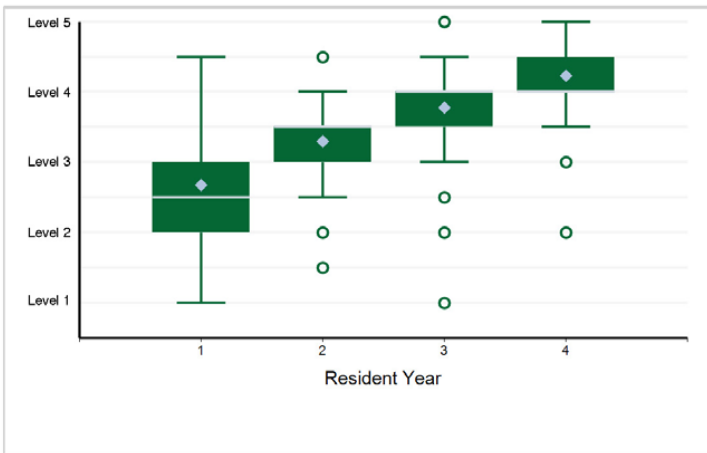

Specialty Box Plot Report - Milestone Evaluation by Resident Year: Year-End 2021-2022

SPECIALTY: **Internal Medicine - Pediatrics**

Pediatrics

1. Patient Care - Patient Care 1: History

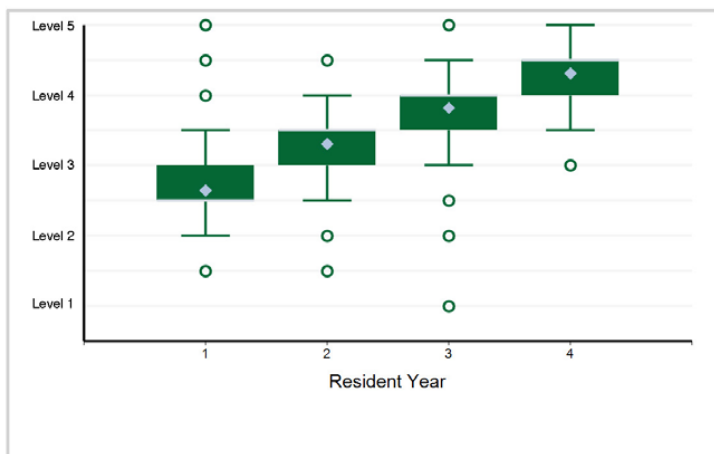

2. Patient Care - Patient Care 2: Physical Exam

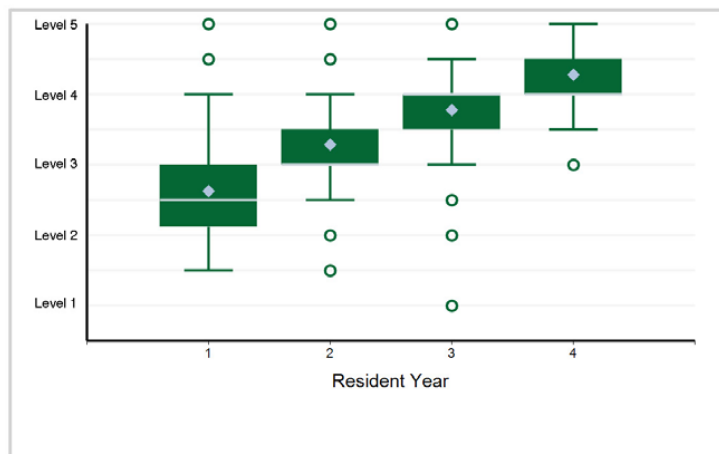

3. Patient Care - Patient Care 3: Organize and Prioritize Patient Care

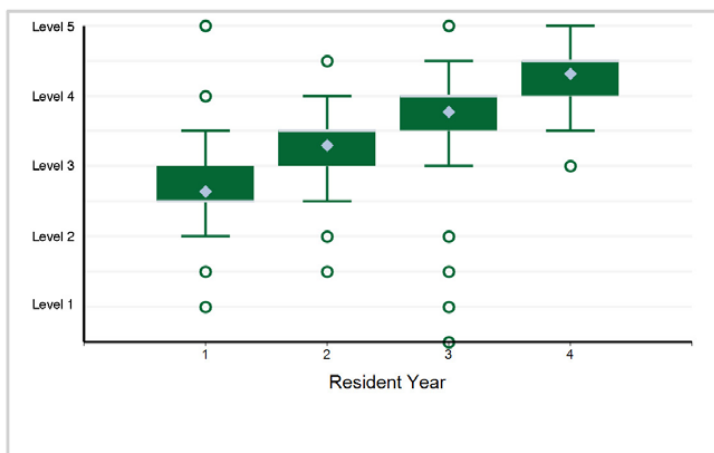

4. Patient Care - Patient Care 4: Clinical Reasoning

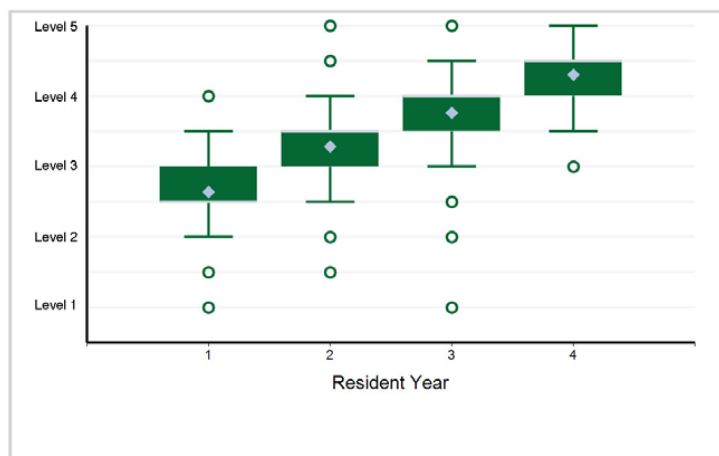

5. Patient Care - Patient Care 5: Patient Management

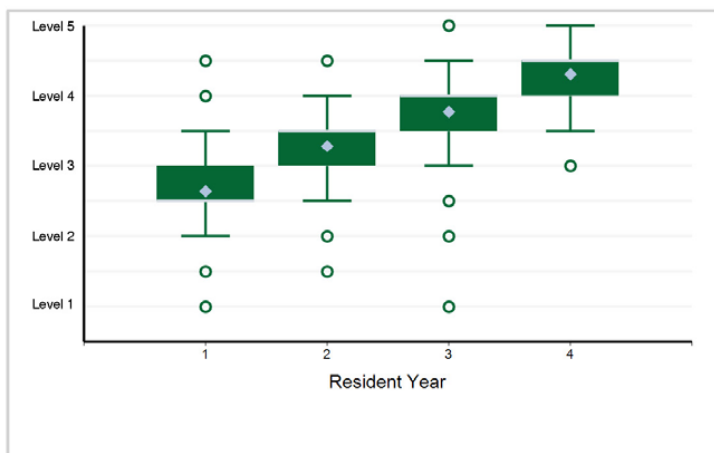

6. Medical Knowledge - Medical Knowledge 1: Clinical Knowledge

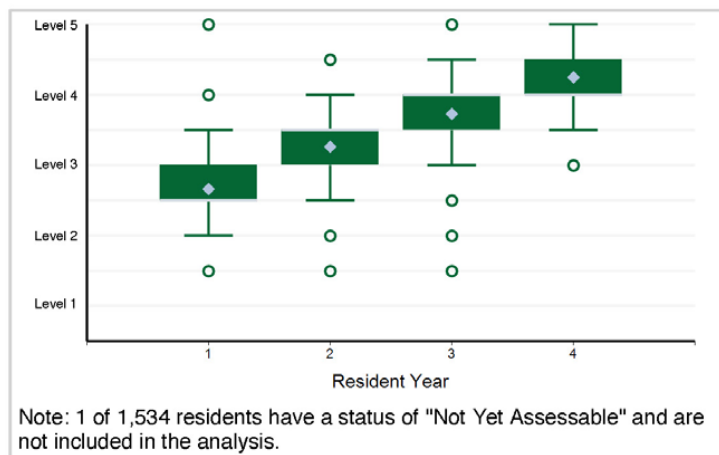

Note: 1 of 1,534 residents have a status of "Not Yet Assessable" and are not included in the analysis.

Specialty Box Plot Report - Milestone Evaluation by Resident Year: Year-End 2021-2022

SPECIALTY: **Internal Medicine - Pediatrics**

Pediatrics

7. Medical Knowledge - Medical Knowledge 2: Diagnostic Evaluation

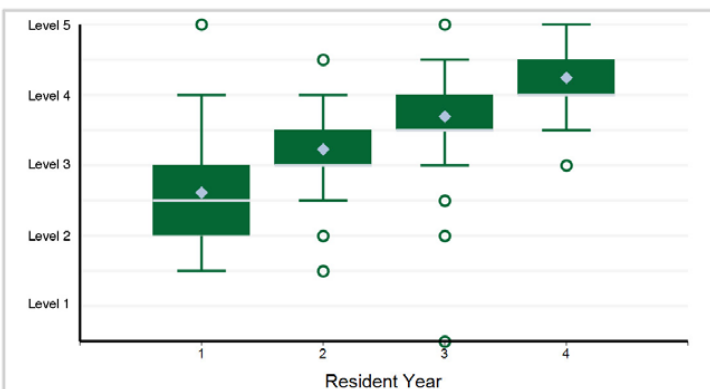

Note: 27 of 1,534 residents have a status of "Not Yet Assessable" and are not included in the analysis.

8. Systems-Based Practice - Systems-Based Practice 1: Patient Safety

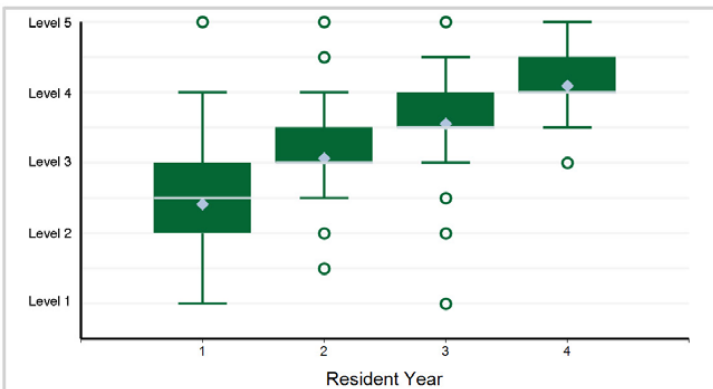

9. Systems-Based Practice - Systems-Based Practice 2: Quality Improvement

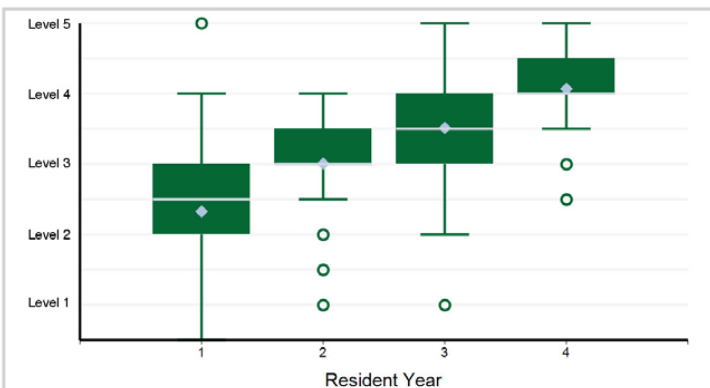

10. Systems-Based Practice - Systems-Based Practice 3: System Navigation for Patient Centered Care – Coordination of Care

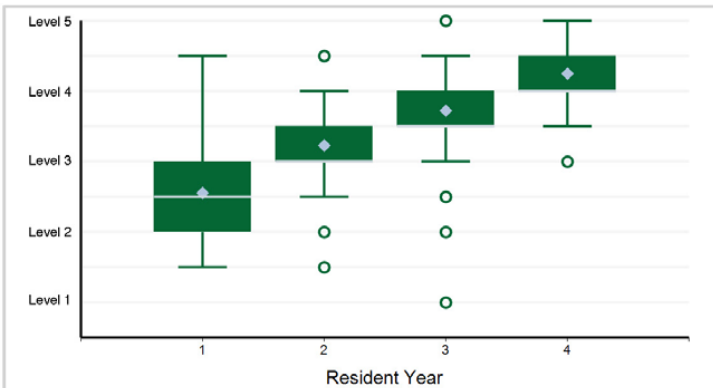

11. Systems-Based Practice - Systems-Based Practice 4: System Navigation for Patient-Centered Care – Transitions in Care

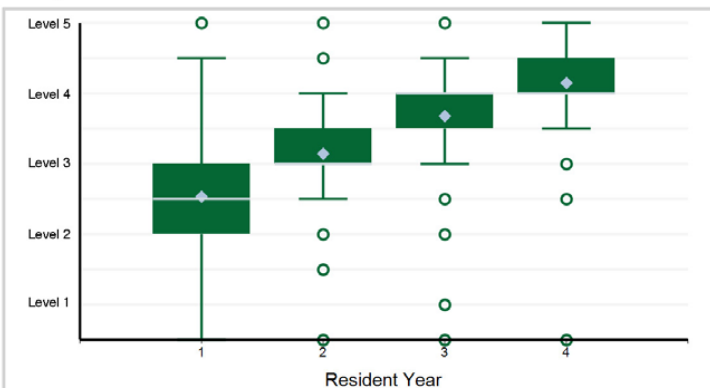

12. Systems-Based Practice - Systems-Based Practice 5: Population and Community Health

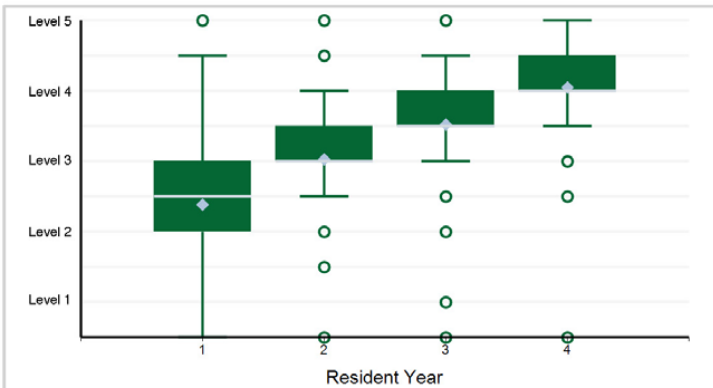

Specialty Box Plot Report - Milestone Evaluation by Resident Year: Year-End 2021-2022

SPECIALTY: **Internal Medicine - Pediatrics**

Pediatrics

13. Systems-Based Practice - Systems-Based Practice 6: Physician Role in Health Care Systems

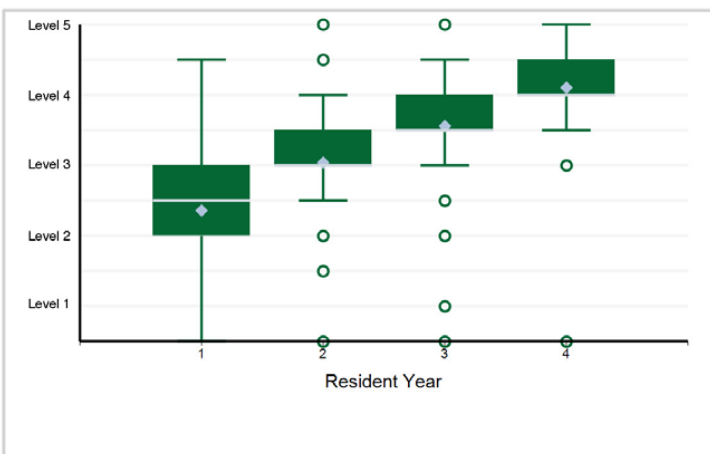

14. Practice-Based Learning and Improvement - Practice-Based Learning and Improvement 1: Evidence-Based and Informed Practice

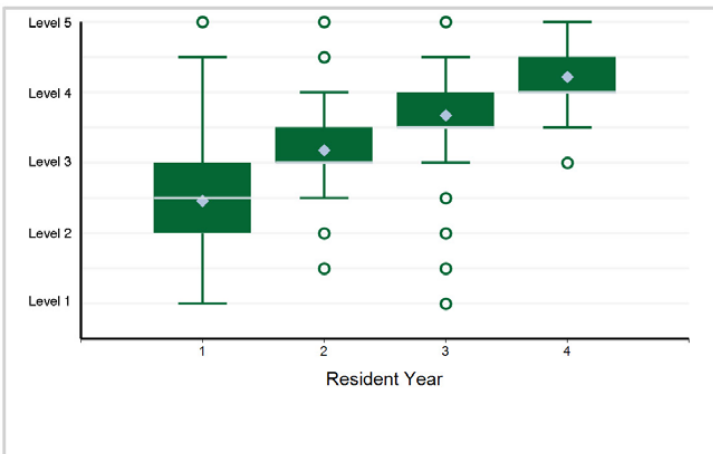

15. Practice-Based Learning and Improvement - Practice-Based Learning and Improvement 2: Reflective Practice and Commitment ...

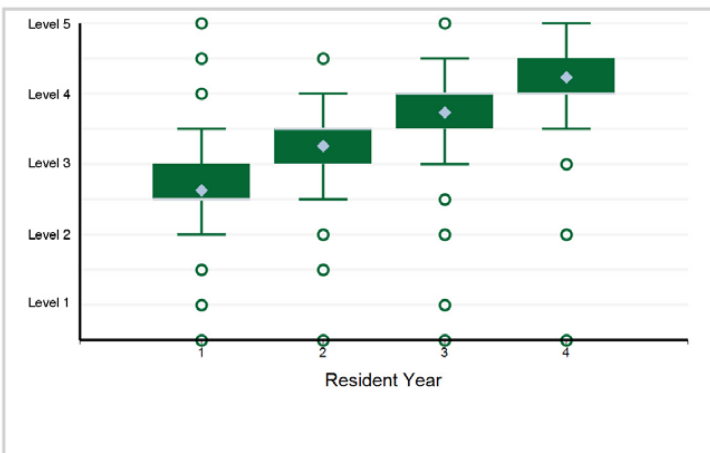

16. Professionalism - Professionalism 1: Professional Behavior

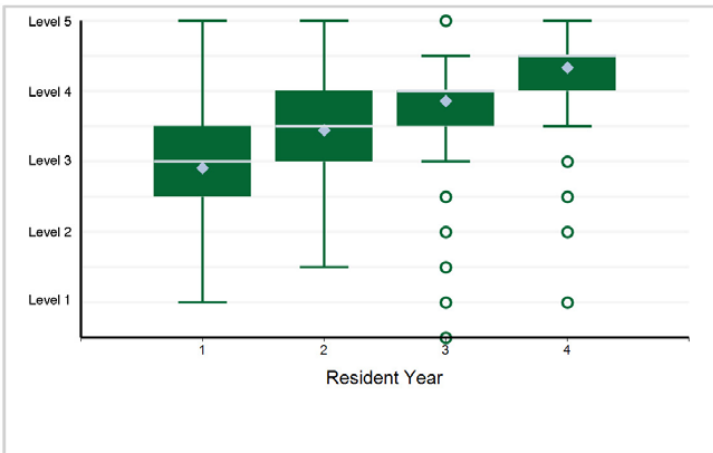

17. Professionalism - Professionalism 2: Ethical Principles

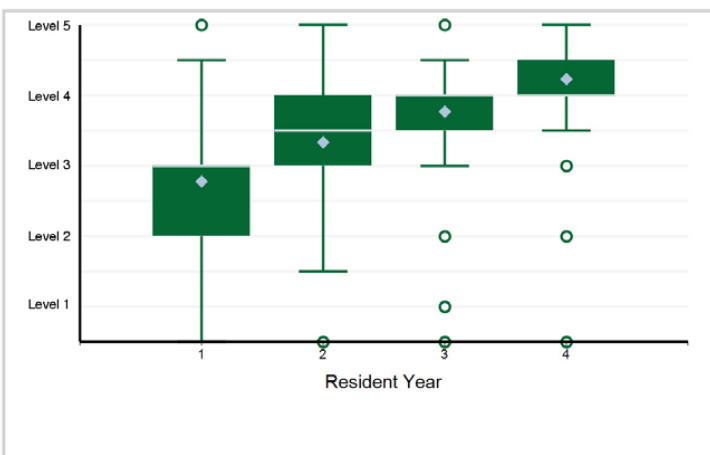

18. Professionalism - Professionalism 3: Accountability/Conscientiousness

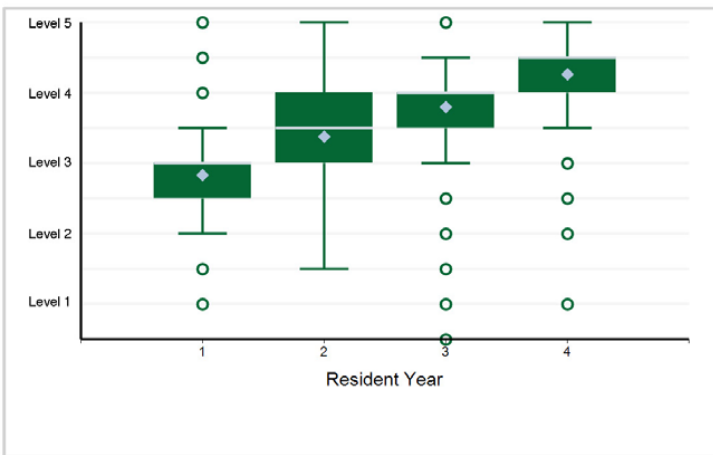

Specialty Box Plot Report - Milestone Evaluation by Resident Year: Year-End 2021-2022

SPECIALTY: **Internal Medicine - Pediatrics**

Pediatrics

19. Professionalism - Professionalism 4: Well-Being

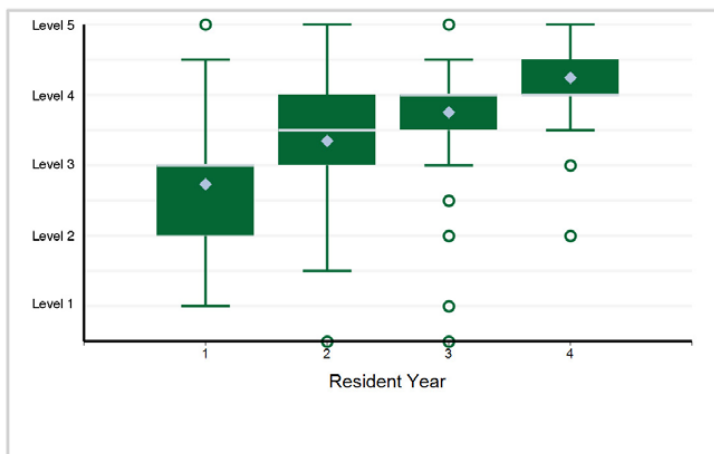

20. Interpersonal and Communication Skills - Interpersonal and Communication Skills 1: Patient- and Family-Centered Communication

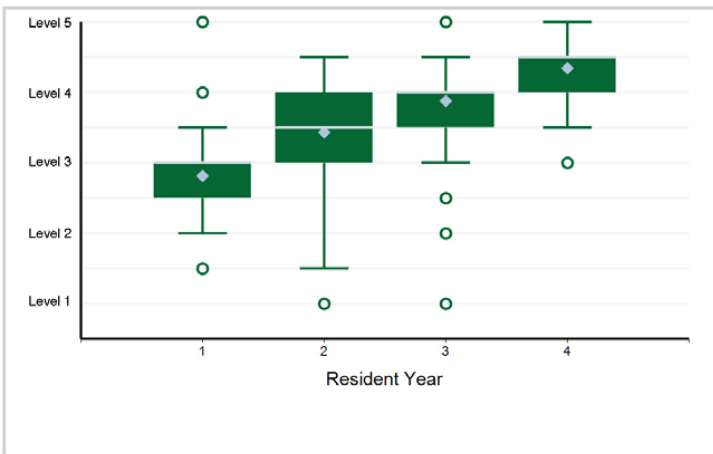

21. Interpersonal and Communication Skills - Interpersonal and Communication Skills 2: Interprofessional and Team Communication

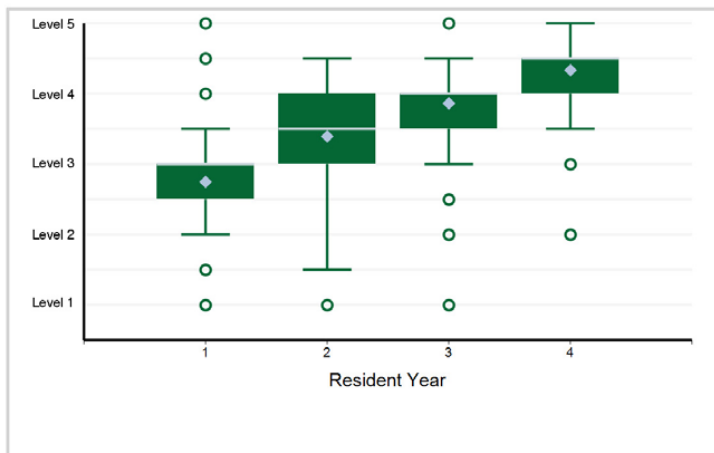

22. Interpersonal and Communication Skills - Interpersonal and Communication Skills 3: Communication within Health Care Systems

